

**QUICK
EASY STEPS**
FOR SETTING UP YOUR PHONE!
SEE YOUR QUICK REFERENCE GUIDE SECTION

Uniden®
OWNER'S MANUAL



2.4GHz
DUAL HANDSET CORDLESS SYSTEM

TRU 4060-2

www.uniden.com

Contents

WELCOME/FEATURES	3	Making Calls Using the Phonebook	28
QUICK REFERENCE GUIDE	5	Speed Dialing	28
CONTROLS AND FUNCTIONS	6	Editing or Erasing a Stored Name, Phone Number, Distinctive Ring, and Speed Dial	29
GETTING STARTED	8	RocketDial (One Touch Dialing)	29
Read This First	8	Chain Dialing	30
Checking the Package Contents	9	CALLER ID	31
Setting up the Phone	10	Viewing the Caller ID List	32
Terminology	14	Deleting Information from the Caller ID List	33
Setting Caller ID Options	15	Using the Caller ID Message List	34
Selecting a Language	17	Call Waiting Deluxe Features	35
BASICS	18	EXPANDING YOUR PHONE	36
Making and Receiving Calls	18	How to Distinguish the Original Handset and the Second Handset	36
Redialing a Call	19	Registering the Second Handset	36
Ringer Volume Setup	20	Call Transfer Feature	37
Ringer Tone Setting	20	Second Handset Operation	38
Distinctive Ringer Setup	21	ADDITIONAL INFORMATION	40
Adjusting the Earpiece Volume	21	Changing the Digital Security Code	40
Mute Microphone	22	Installing the Beltclip	41
Tone Dialing Switch-over	22	Headset Installation	41
Traveling Out-of-Range	22	Note on Power Sources	42
Selecting a Different Channel	23	Maintenance	42
Find Handset	23	General Information	43
Flash and Call Waiting	23	TROUBLESHOOTING	44
Voice Mail LED	23	PRECAUTIONS & WARRANTY	45
PHONEBOOK	24	I.C. NOTICE	47
Storing Phone Numbers, Names, Distinctive Rings, and Speed Dial	24	INDEX	48
Steps for Entering Names and Special Characters	25		
Viewing the Phonebook	27		

Welcome

Congratulations on your purchase of the Uniden cordless telephone. This phone is designed and engineered to exacting standards for reliability, long life and outstanding performance. To enjoy the best performance from this phone's features, please read this manual carefully and save it for future reference.

Note: Some illustrations in this manual may differ from the actual unit for explanation purposes.



As an Energy Star® Partner, Uniden has determined that this product or product models meets the Energy Star® guidelines for energy efficiency.

Energy Star® is a U.S. registered mark.

Features

- 2.4 GHz Spread Spectrum Technology
- Two Handset Expandability
- Caller ID and Call Waiting Caller ID
- Dynamic Memory Location for Caller ID Messages and Phonebook Locations (up to 100 numbers in total)
- Trilingual Language Option
- 6 Hour Talk Time
- 10 Day Standby Battery Life
- 3-Line, 16 Character Backlit Handset Display
- One Touch Dialing
- Call Transfer
- 32 Digit Redial / 3 Last Number Redial Locations
- 10 Distinctive Ring Options (6 ringers and 4 melodies)
- Flash and Pause
- Find Handset
- Hearing Aid Compatible
- Tone/Pulse Dialing
- Handset Earpiece and Ringer Volume Control

The TRU4060-2 features include **AutoTalk™** and **AutoStandby™**. AutoTalk allows you to answer a call by just removing the handset from the base so you don't have to waste time pushing buttons. AutoStandby allows you to hang up by simply returning the handset to the base.

To protect you against mis-billed calls, which might result from your phone being activated by other equipment, the TRU4060-2 has **Random Code™** digital security, which automatically selects one of over 65,000 digital security codes for the handset and base. Also, **AutoSecure™** electronically locks your phone when the handset is in the base.

RocketDial™ is a one touch speed dial key that automatically dials your most important or frequently called number. The number dialed, is a preset number stored by the user.

Digital Spread Spectrum Technology utilizes a “wider frequency band” vs. a “single narrow band” used in standard digital transmissions. The result is a more secure conversation with the clarity of digital sound, extended range, and minimal interference from other cordless phones.

Call Transfer allows you to transfer outside calls from handset to handset, only one handset at a time can talk with an outside caller.

Be sure to visit our web site: www.uniden.com

Uniden® is a registered trademark of Uniden America Corporation.

AutoTalk, AutoStandby, Random Code, AutoSecure, and RocketDial are trademarks of Uniden America Corporation.

Step 1 Charging the Battery

INSTALL THE HANDSET BATTERY

- 1 Remove the cover.

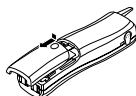

- 2 Connect the battery pack connector with the correct polarity.

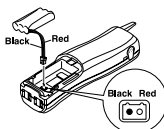

- 3 Replace the cover.

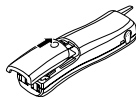

PLUG INTO AC POWER

- 1 Plug the AC adapter cord into the base unit and then to a 120V AC outlet.

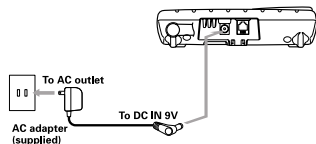

- 2 Place the handset in the base.

Note: You must charge the battery pack continuous for 15-20 hours before using the phone.

Step 2 Connecting

CONNECT TO A PHONE LINE

When the handset battery pack is fully charged, plug the telephone cord into the base unit and then into a telephone wall jack.

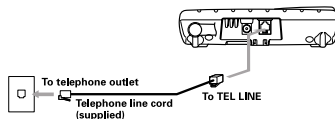

Your phone is set for tone dialing. If your local network requires pulse dialing, please see "Setting up the phone, Choose the dialing mode" in your owner's manual.

Step 3 Setting up the Caller ID Options/Language



Note: Three Caller ID options are available: Auto Talk, Caller ID on Call Waiting (CIDCW) and Area Code.

TO SELECT CALLER ID OPTIONS

- 1 Press **menu/mute**.
- 2 Press **+ or -** to move the pointer to "Caller ID Setup", then press **select/ch**.
- 3 Press **+ or -** to move the pointer to an option, then press **select/ch**.
- 4 Press **+ or -** to change the option setting.
- 5 Press **select/ch** and return the handset to the base.

TO CHOOSE THE LANGUAGE

- 1 Press **menu/mute**.
- 2 Press **+ or -** to move the pointer to "Language", then press **select/ch**.
- 3 Press **+ or -** to change the option setting.
- 4 Press **select/ch** and return the handset to the base.

Controls and Functions

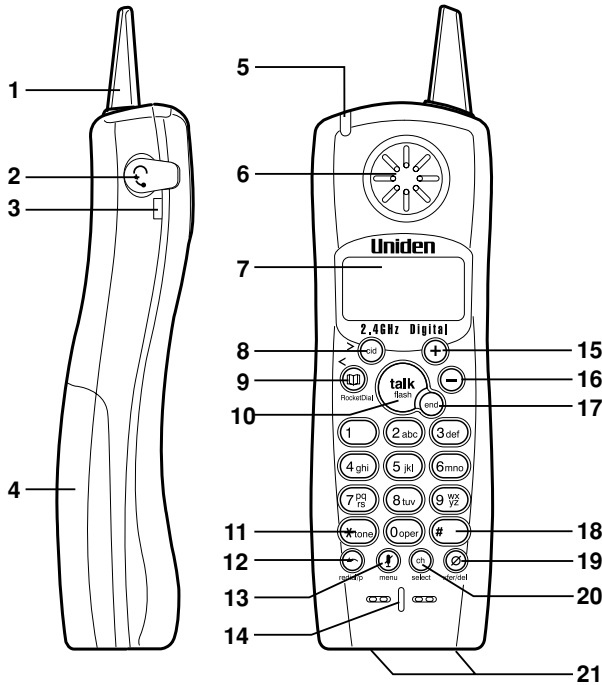

1. Handset Antenna
2. Headset Jack Cover
3. Beltclip Hole
4. Handset Battery Compartment
5. Voice Mail LED
6. Handset Earpiece
7. LCD Display
8. CID (Caller ID)/> (right cursor) Key
9. ☎ (Phonebook)/RocketDial/< (left cursor) Key
10. Talk/flash Key
11. */tone Key
12. ⏪ (redial)/p (pause) Key
13. 📴 (mute)/menu Key
14. Handset Microphone
15. + (up) Key
16. - (down) Key
17. End Key
18. # Key
19. Xfer (transfer)/∅ del (delete) Key
20. Ch (channel)/select Key
21. Handset Charging Contacts

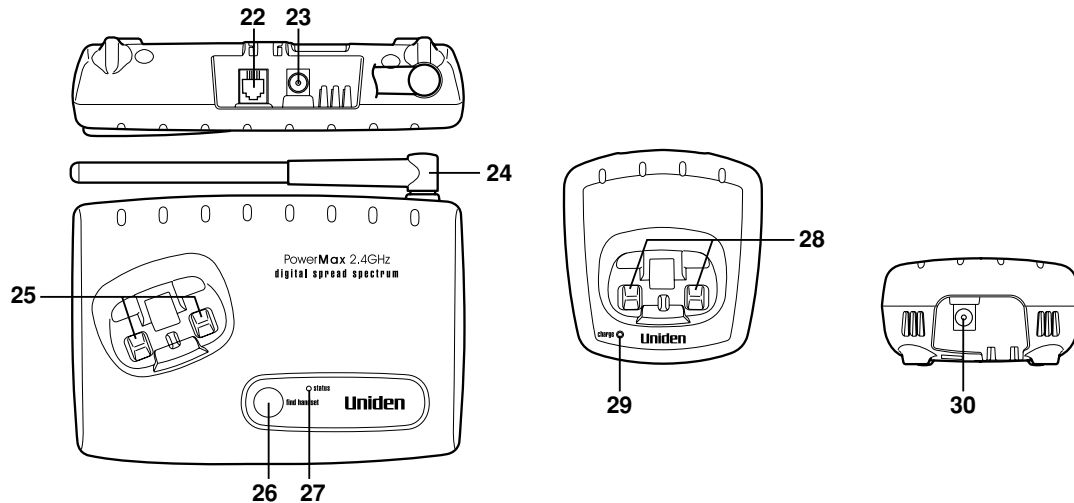

- 22. Telephone Line Jack
- 23. DC Power Input
- 24. Base Antenna
- 25. Base Charging Contacts
- 26. Find Handset Key
- 27. Status LED

- 28. Charging Contacts
- 29. Charge LED
- 30. DC Power Input

Read this First

This cordless telephone must be set up before use. Follow these steps:

Step 1 (page 9)

Unpack the telephone and accessories.

Step 2 (page 10)

Next, choose the best location to set up the base unit.

Step 3 (page 11 to 14)

Then, insert the battery pack into the handset. Connect the base unit. You must charge the battery pack **for 15-20 hours before plugging into the phone line and using the phone.**

Step 4 (page 15 to 17)

Finally, set the Caller ID options, and store your area code in the memory to use the Caller ID service. Choose the language of your display.

Note: Skip the area code setting if your calling area requires 10-digit dialing.

About the digital security code

This cordless telephone uses a digital security code to prevent unauthorized access to your base unit. This security code prevents other cordless handsets from making calls through your base unit. If you want to reset the security code, see page 40.

Checking the Package Contents

Make sure you have received the following items in the package. If any of these items are missing or damaged, contact the Uniden Parts Department.

- Base unit (1)
- Handset (2)
- AC adapter (2)
- Rechargeable battery (2)
- Telephone cord (1)
- Beltclip (2)
- Charging Cradle (1)

Also included:

- This Owner's Manual
- Other Printed Material

* For operations and restrictions on the second handset, read "Expanding your phone" on page 36.

Uniden Parts Department
(800) 554-3988
Hours: M-F 7:00 a.m. to 5:00 p.m. CST.
We can also be reached on the web at www.uniden.com.

Setting up the Phone

Do the following steps:

- A. Choose the best location
- B. Install the battery pack
- C. Connect the base unit
- D. Choose the dialing mode

A. Choose the best location

Before choosing a location for your new phone, read "Installation Considerations" on page 46. Here are some important guidelines you should consider:

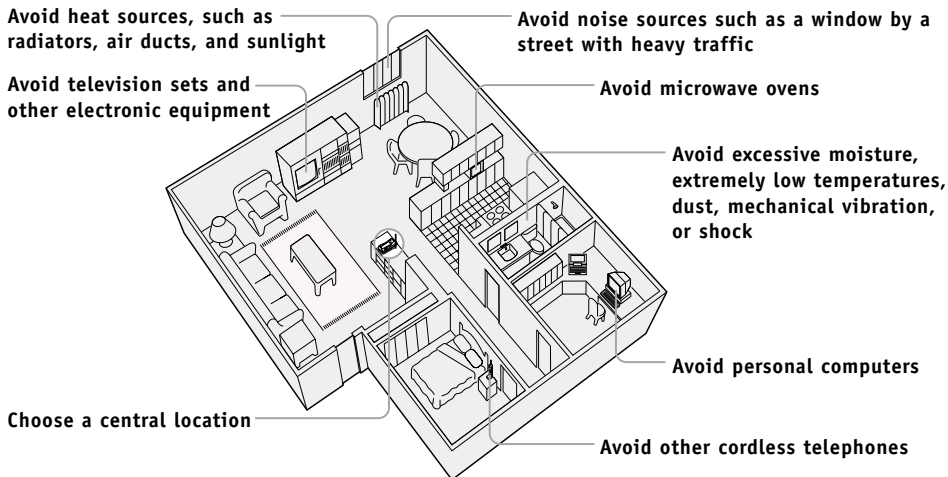

B. Install the battery pack

Charge the battery pack for at least 15-20 hours before plugging the phone line into your base unit.

- 1) Press down on the battery cover release and slide the cover down until it comes off.
- 2) Connect the battery pack connector observing the correct polarity (black and red wires) to the jack inside the battery compartment.

Do not exert any force on this connection. It could cause damage to the battery or to the handset. The plastic connectors will fit together in only one way. Once you are certain that you have made a good connection, then insert the battery pack into the battery compartment. Do not pinch the wires.

- 3) Securely close the battery compartment cover by sliding it up until it snaps into place.
- 4) Place the handset in the charging cradle with the keypad facing forward.

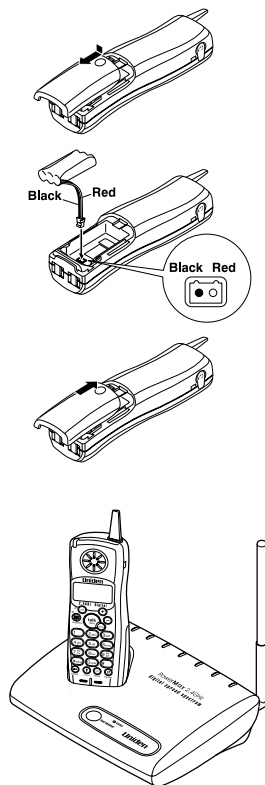

- Use only the Uniden battery (BT-446) supplied with your phone. Replacement batteries are also available through the Uniden Parts Department. (See page 9.)
- Recharge your phone on a regular basis by returning the handset to the base after each phone call.

Battery use time (per charge)

Fully charged

- 6 hours continuous use
- 10 days when the handset is in the standby mode

note When you charge the handset, Caller ID summary screen and the name of the handset, HS1 appears. If HS2 appears, you are charging the handset No.2.

```
HS1
New : 1
Total: 2
```

Low battery alert

When the battery pack is very low and needs to be charged, the phone is programmed to eliminate functions in order to save power. If the phone is in the standby mode, "Low Battery" appears on the LCD and none of the keys will operate. If the phone is in use, "Low Battery" appears and the handset beeps. Complete your conversation as quickly as possible and return the handset to the base unit for charging.

```
Low Battery
```

note The last number dialed in the redial memory is retained for up to 2 minutes while you replace the battery pack.

Cleaning the battery charging contacts

To maintain a good charge, it is important to clean the battery contacts on the handset and base unit with a dry cloth or a pencil eraser about once a month.

Do not use any liquids or solvents.

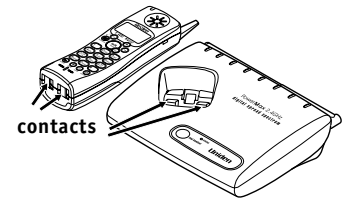

C. Connect the base unit

- 1) Connect the AC adapter to the **DC IN 9V** jack and to a standard 120V AC wall outlet.
- 2) Set the base and charger on a desk or tabletop, and place the handset in the base unit as shown.
- 3) Raise the antenna to a vertical position.
- 4) Make sure the **status** LED illuminates. If the LED does not illuminate, check to see that the AC adapter is plugged in and that the handset makes good contact with the base charging contacts.



- **Use only the supplied AD-312 AC adapter.** Do not use any other AC adapter.
 - Connect the AC adapter to a continuous power supply.
 - Place the base unit close to the AC outlet so that you can unplug the AC adapter easily.
- After installing the battery pack in the handset, charge your handset at least **15-20 hours before plugging into the phone line.** Once the handset battery pack is fully charged, connect the telephone line cord to the base and telephone wall outlet.

- 5) Connect the telephone line cord to the **TEL LINE** jack and to a telephone outlet once the handset is fully charged.



If your telephone outlet isn't modular type, contact your telephone company for assistance.



Modular

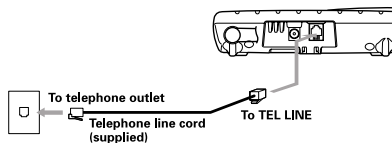
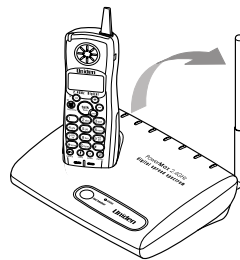
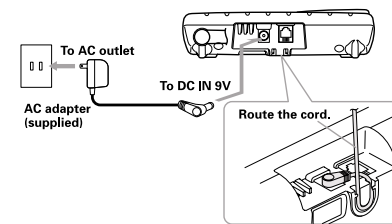

Place the power cord so that it does not create a trip hazard or where it could become chafed and create a fire or electrical hazard.



- If you are not sure of your dialing system, set the unit to tone dialing. Make a trial call. If the call connects, leave the setting as is, otherwise set the unit to pulse dialing.
- If your phone system requires pulse dialing and you need to send DTMF tones in certain situations during a call, you may “switch-over” to tone dialing. (Refer to “Tone Dialing Switch-over” on page 22.)

D. Choose the dialing mode

Most phone systems use tone dialing, which sends DTMF tones through the phone lines. However some phone systems still use pulse dialing such as in rural areas. The default setting is tone dialing. Depending on your dialing system, set the mode as follows:

- 1) When the phone is in the standby mode, press *menu/mute*.

```
▶Ringer Volume
Ringer Tones
Distinct. Ring
```

- 2) Press - to move the pointer to “Dial Mode”.

```
Distinct. Ring
Caller ID Setup
▶Dial Mode
```

- 3) Press *select/ch* and the display will show the current setting. (The initial setting is Tone.)

```
▶Tone Dialing
Pulse Dialing
```

- 4) Press + or - to change the selection.

- 5) Press *select/ch* and a confirmation tone will sound.

- 6) Press *end* to exit.

Terminology

Throughout this manual, terms such as Standby and Talk Mode are used. Below is the terminology explanation.

Standby Mode - The handset is not in use, is off the base, and *talk/flash* has not been pressed. A dial tone is not present and the display is blank.

Talk Mode - The handset is not on the base and *talk/flash* has been pressed enabling a dial tone. “Talk” appears on the display.

Setting Caller ID Options

There are three Caller ID setup options available: AutoTalk, CIDCW (Caller ID on Call Waiting), and Area Code. See page 16 for Area Code setup instructions.

AutoTalk allows you to answer the phone without pressing **talk/flash**. If the phone rings when AutoTalk is On, simply remove the handset from the base and the phone automatically answers the call. Or if the handset is not on the base, press any number key, ***tone**, or **#** to answer the call. If you set AutoTalk to Off, you must press **talk/flash** to answer the call.

Caller ID on Call Waiting (CIDCW) performs the same as regular Caller ID on a call waiting number. CW Deluxe allows you to handle call waiting calls in seven different ways. (See page 35.)

You must subscribe to CIDCW from your phone company in order to use this feature. The CW Deluxe is a separate service available through your phone company.

To change your Caller ID options:

1) When the phone is in the standby mode, press **menu/mute**.

```
Ringer Volume
Ringer Tones
Distinct. Ring
```

2) Press **+** or **-** to move the pointer to "Caller ID Setup", then press **select/ch**.

```
Ringer Tones
Distinct. Ring
▶ Caller ID Setup
```

3) Press **+** or **-** to choose "Auto Talk" or "CIDCW", then press **select/ch**.

```
▶ Auto Talk
CIDCW
Area Code
```

4) Press **+** or **-** to change the selection.

AutoTalk: "Auto Talk On" or "Auto Talk Off"

```
Auto Talk On
▶ Auto Talk Off
```

CIDCW: "CIDCW On", "CW Deluxe On" or "CIDCW Off"

```
▶ CIDCW On
CW Deluxe On
CIDCW Off
```

5) Press **select/ch** and a confirmation tone will sound. To complete the setting, make sure to return the handset to the base.



- If your calling area requires 10-digit dialing, do not program this option.
- When the area code has already been stored in memory, the stored area code will be displayed. To change it, press **xfer/del** and the number keypad to enter the new area code.
- To complete the setting, press **select/ch**, then return the handset to the base.

Entering Your Area Code

If you enter a 3-digit area code number in the “Area Code” option, your local area code does not appear in Caller ID messages. For calls received from outside your local area code, you will see a full 10-digit number.

- 1) When the phone is in the standby mode, press **menu/mute**.

```
▸ Ringer Volume
  Ringer Tones
  Distinct. Ring
```

- 2) Press **+** or **-** to move the pointer to “Caller ID Setup”, then press **select/ch**.

```
Ringer Tones
Distinct. Ring
▸ Caller ID Setup
```

- 3) Press **+** or **-** to move the pointer to “Area Code”, then press **select/ch**.

```
Auto Talk
CIDCW
▸ Area Code
```

- 4) Use the number keypad (**0** to **9**) to enter a 3-digit area code.

```
▣ Area Code
```

- 5) Press **select/ch**, and a confirmation tone will sound.

Selecting a Language

Language option can be used to choose the language of your display. You can select English, French, or Spanish.

- 1) When the phone is in the standby mode, press **menu/mute**.

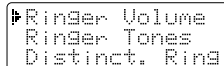

```
▸ Ringer Volume
Ringer Tones
Distinct. Ring
```

- 2) Press - to move the pointer to "Language", then press **select/ch**.

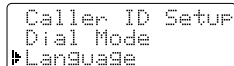

```
Caller ID Setup
Dial Mode
▸ Language
```

- 3) Press + or - to choose English, French (Français), or Spanish (Español).
- 4) Press **select/ch**, and a confirmation tone will sound.

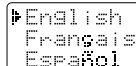

```
▸ English
Français
Español
```



Refer to page 15 “Setting Caller ID Options” to turn the AutoTalk feature On if desired. Any key answer can be used only when AutoTalk is set to On.

Making and Receiving Calls

	Handset On Base	Handset Off Base
To answer a call	Pick up the handset (AutoTalk) or pick up the handset and press talk/flash .	Press any number key, *tone , or # (Any Key Answer), or press talk/flash .
To make a call	<ol style="list-style-type: none">1) Pick up the handset.2) Press talk/flash.3) Listen for the dial tone.4) Dial the number. <p>OR</p> <ol style="list-style-type: none">1) Pick up the handset.2) Dial the number, then press talk/flash.	<ol style="list-style-type: none">1) Press talk/flash.2) Listen for the dial tone.3) Dial the number. <p>OR</p> <p>Dial the number, then press talk/flash.</p>
To hang up	Press end , or return the handset to the base (AutoStandby).	
To enter a pause within the dialing sequence	When you dial the number, press redial/p before pressing talk/flash . “P” appears in the display which represents a pause.	

Redialing a Call

The last three phone numbers dialed can be quickly redialed.

Redialing from Standby Mode

- 1) Press **redial/p**. The phone number that was last dialed appears on the display.
- 2) Press **redial/p** again. Each press of **redial/p** will display one of the last three numbers dialed.
- 3) Press **talk/flash**. The selected number is dialed. To hang up, press **end**.

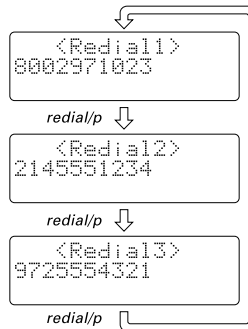

Redialing from Talk Mode

- 1) Press **talk/flash**.
- 2) Press **redial/p**. The last number dialed will be displayed and redialed. To hang up, press **end**.



- If the number exceeds 32 digits, only the first 32 digits are retained for redial.
- If you have not pressed any key for 30 seconds, the phone returns to standby mode.
- If you press **end**, the operation is canceled and the phone will return to the standby mode.
- If the redial memory is empty, you will hear a beep.
- When using the redial feature in talk mode, only the last number dialed will be displayed.



- If you select "Ringer Off", <Ringer Off> appears on the display when you make or receive calls, or charging the handset.

- If you set the ringer to Off, the ringer tone will not sound.

Ringer Volume Setup

- 1) When the phone is in the standby mode, press **menu/mute**.
- 2) Press **select/ch**.
- 3) Press + or - to move the pointer through the ringer settings (Ringer Off, Ringer Low, or Ringer High).
You will hear a ringer or melody at the selected volume.
- 4) Press **select/ch**, and you will hear a confirmation tone.

```
Ringer Volume
Ringer Tones
Distinct. Ring
```

```
Ringer Off
Ringer Low
Ringer High
```

Ringer Mute (temporarily)

You can temporarily mute the ringer tone. When the handset is off the base and the phone is ringing, press **end**. The ringer tone will return to the previous setting starting with the next incoming call.

Ringer Tone Setting

- 1) When the phone is in the standby mode, press **menu/mute**.
- 2) Press - to move the pointer to "Ringer Tones", then press **select/ch**.
You can choose from 6 ringers or 4 melodies:
 - Ringer [Flicker, Clatter, Leap Frog, Ping Ball, Reminder, Soft Alert]
 - Melodies [Beethovens9, For Elise (Elise), Merry Christmas (Merry-Xmas), Home Sweet Home (Hm Swt Hm)]
- 3) Press + or - to move the pointer. You will hear the ringer or the melody as you scroll through the options.
- 4) Press **select/ch** and you will hear a confirmation tone.

```
Ringer Volume
Ringer Tones
Distinct. Ring
```

```
Ringer Volume
Ringer Tones
Distinct. Ring
```

```
Flicker
Clatter
Leap Frog
```

Distinctive Ringer Setup

“Distinctive Ringer” allows you to preset memory locations with a designated ring tone. When an incoming call is received and the Caller ID information matches the information in one of the memory locations, the Distinctive Ring that has been stored for that particular caller will sound.

If you have set multiple memory locations with distinctive rings, switching the setting to “Distinctive Off” will result in no distinctive ringing. All incoming calls will have a normal ring tone. Switching to “Distinctive On” will activate all programmed distinctive ring memory locations.

- 1) When the phone is in the standby mode, press **menu/mute**.
- 2) Press **-** to move the pointer to “Distinct. Ring”, then press **select/ch**.
- 3) Press **+** or **-** to choose “Distinctive On” or “Distinctive Off”.
- 4) Press **select/ch** and you will hear a confirmation tone.

```
Ringer Volume
Ringer Tones
Distinct. Ring
```

```
Ringer Volume
Ringer Tones
▶ Distinct. Ring
```

```
▶ Distinctive On
Distinctive Off
```

Adjusting the Earpiece Volume

The handset earpiece volume settings (Volume Low, Volume Medium, Volume High, and Volume Maximum) can only be adjusted during a call. Press **-** or **+** to select the volume setting. When you hang up, the phone keeps the last volume setting selected.

note When you press **+** in maximum volume level or **-** in lowest volume level, an error tone sounds.



See “Storing Phone Numbers, Names, Distinctive Rings, and Speed Dial” on page 24 for storing a Distinctive Ring in the Phonebook.

Mute Microphone

You can temporarily turn Off the microphone so that the person you are talking with cannot hear you. During a telephone call press and hold **menu/mute** to turn Off the microphone, and "Mute" appears on the display. Press **menu/mute** again to cancel muting.

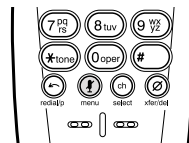

note If you press **end** to cancel muting, the call is disconnected and the phone will return to standby mode.



- The tone feature only applies when the dial mode is set to pulse.
- This special number can be stored in a memory location. This is referred to as Chain Dialing (See page 30.)

Tone Dialing Switch-over

Some telephone companies use equipment that requires pulse dialing (sometimes referred to as rotary dialing). If you need to enter tone dialing digits, you can switch-over to tone dialing during the call. For example, entering your bank account number after you have called your bank.

Initially make your call with the pulse dialing mode. Once your call connects, press ***tone**. Enter the desired number. These digits will be sent as tone dialing. Once the call ends, the tone mode is canceled and pulse dialing mode resumes.

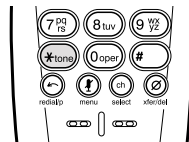

Traveling Out-of-Range

During a call, as you begin to move your handset too far from your base unit, noise increases. If you pass the range limits of the base unit, your call will terminate within 30 seconds.

Selecting a Different Channel

If you encounter interference while using your phone, you can manually change the phone's channel for clear operation. This function works only when the phone is in use.

Press **select/ch**. "Scanning" appears on the display, indicating the phone is changing to another channel. For more information on interference, refer to "Radio Interference" on page 46.

Find Handset

To locate the handset, press **find handset** on the base. The handset beeps for 60 seconds, and "Paging" appears on the display. Paging is canceled when pressing any key on the handset or **find handset** on the base. Additionally, if you receive an incoming call, page is canceled.

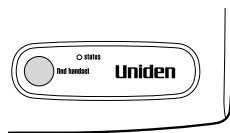

Flash and Call Waiting

If you have **Call Waiting** service and a call waiting tone sounds while you are on a call, press **talk/flash** to accept the waiting call. There is a short pause, then you will hear the new caller. To return to the original caller, press **talk/flash** again.

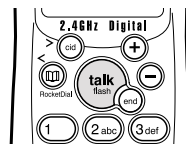

Voice Mail LED

The voice mail LED on the handset is designed to work with your voice mail service provided by your local telephone company. The LED flashes when you have new incoming messages in the voice mail service.

You may need to occasionally reset the indicator if it remains On after you've retrieved your messages. To reset the indicator, when the phone is in the standby mode press and hold **find handset** on the base until the paging sound stops (about 5 seconds).

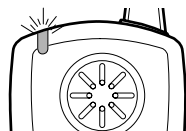

- If the handset battery is completely drained, the handset will not beep when paging.
- You must subscribe through your local telephone company to receive Call Waiting Service.





- If you press *end* or don't press a key within 30 seconds while in the storing operation, the phone will return to the standby mode.
- When the memory is full, you will hear a beep and "Memory Full" appears. You cannot store names and numbers.
- The pause key counts as one digit. Pressing *redial/p* more than once increase the length of pause between numbers.

Phonebook

Phonebook allows you to dial a number using just a few key presses. Your phone stores names/numbers in the phonebook memory location, and you can search names in alphabetical order. You have a total of 100 locations that can be used for the phonebook (including the Speed dials) and Caller ID messages.

note If you get an incoming call, a transferring call, or page, the operation is canceled.

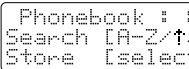
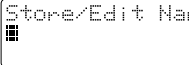
Storing Phone Numbers, Names, Distinctive Rings, and Speed Dial

- 1) When the phone is in the standby mode, press *pb/rocket/*<. The handset displays the number of the phonebook locations used, and information on searching and storing phonebook locations.
(1st line) the number of the phonebook locations used
(2nd line) How to search (the number keypad, + or -)
(3rd line) How to enter the storing operation (Press *select/ch*)

- 2) Press *select/ch*, then "Store/Edit Name" appears.

- 3) Store the name (up to 16 characters) by using the number keypad.
 - See the "Steps for entering names and special characters" (see page 25).
 - Use *cid/*> and *pb/rocket/*< to move the cursor to the desired location.
 - Use *xfer/del* to delete characters as needed.
 - Press and hold *xfer/del* to delete all the characters.If a name is not required, go to step 4.
- 4) Press *select/ch* to store the name, then "Store/Edit No." appears.

- 5) Press the number keypad to enter the phone number (up to 20 digits), then press *select/ch* to store the number.

6) “Distinctive Ring” appears. Then press + or - to move the pointer to one of the Distinctive Ring options, then press **select/ch**.

```
Distinctive Ring
▶No Selectn
Flicker
```

note If you choose not to store a “Distinctive Ring”, simply select the “No Selectn” option.

7) “Speed Dial” appears. Then press - to move the pointer to select the speed dial location (10 locations: SPD1-SPD0).

```
Speed Dial
▶No Selectn
SPD1:Uniden Cor
```

note If you choose not to store the name/number as a Speed Dial, simply select the “No Selectn” option.

8) Press **select/ch**. You will hear a confirmation tone and “Done!” appears on the display.

```
Uniden Corp
800-297-1023
▶Soft Alert/SPD1
```



If you select a speed dial location where a number is already stored, the new number will replace the old number, and the old number will be stored as a phonebook location.

Steps for Entering Names and Special Characters

Refer to the letters on the number keys to select the desired characters. With each press of a number key (0-9), the displayed character appears in the following order: Upper case letters first, lower case letters next and finally the number corresponding to the key.

	Number of times key is pressed								
keys	1	2	3	4	5	6	7	8	9
1	1								
2abc	A	B	C	a	b	c	2		
3def	D	E	F	d	e	f	3		
4ghi	G	H	I	g	h	i	4		
5jkl	J	K	L	j	k	l	5		
6mno	M	N	O	m	n	o	6		
7pqrs	P	Q	R	S	p	q	r	s	7
8tuv	T	U	V	t	u	v	8		
9wxyz	W	X	Y	Z	w	x	y	z	9
0	*	#	-	&	()	(blank)	0	

If you make a mistake while entering a name

Use *pb/rocket/*< or *cid/*> to move the cursor to the incorrect character. Press *xfer/del* to erase the wrong character, then enter the correct character. To delete all characters, press and hold *xfer/del*.

For example, to enter **Uniden**:

- 1) When the phone is in the standby mode, press *pb/rocket/*<. The handset displays the number of phonebook locations you have stored, and how to search and store the phonebook locations.
- 2) Press *select/ch*, then "Store/Edit Name" appears.
- 3) Press **8** twice.
- 4) Press **6** five times.
- 5) Press **4** six times.
- 6) Press **3** four times, then press *cid/*> to move the cursor to the right.

 If the next character uses the same number key, you must press *cid/*> to move the cursor over. Otherwise the next time you press the number key, it changes the character that was previously set.

- 7) Press **3** five times.
- 8) Press **6** five times.
- 9) When finished, press *select/ch*.

To continue to store the telephone number, proceed to step 5 on page 24.

Viewing the Phonebook

Your phone stores names/numbers in the phonebook memory locations, and you can search names in alphabetical order. You can view the phonebook during a call as well as when the phone is in the standby mode.

- 1) Press **pb/rocket/**<.

If you press **pb/rocket/**< during a call, the following screen appears.

```
Phonebook : 85
Search [A-Z/↑/↓]
Store [select]
```

```
Phonebook : 85
Search [A-Z/↑/↓]
```

- 2) Press + or -, or the number keypad to view the phonebook locations.

a) Alphabetical order

Ascending order: Press - to view locations. The location in the RocketDial appears first in the display. Each time - is pressed, phonebook locations appear in ascending order.

Descending order: Press + to view locations. A name starting with a number or a mark, or unknown name appears first. Each time + is pressed, phonebook locations appear in descending order.

b) From a number key

Refer to the letters on the number keys to select the first letter of the desired name. Press a number key until any name with the same initial is displayed (See the table in "Steps for Entering Names and Special Characters" on page 25). For example, to search for "Uniden", press 8 two times. Press - or + until the name is displayed. If you press + while the first name in "U" is displayed, a name starting with "T" will appear, or if you press - while the last name in "U" is displayed, a name starting with "V" will appear.

- 3) Press **pb/rocket/**< (if you view the phonebook during a call) or **end**.



- "/SD" appears on the display when you review the RocketDial, and "/SPDn" appears when you review a Speed dial.
- If you view the phonebook during a call and receive a CIDCW (Caller ID on Call Waiting), the viewing operation will be canceled.
- If you press **end** while in the operation, the phone will return to the standby mode (or a call will be disconnected when you view the phonebook during a call).
- If you don't press a key within 30 seconds while in the operation, the phone will return to the standby mode (or back to a call when you view the phonebook during the call).

Making Calls Using the Phonebook

From Standby Mode

- 1) When the phone is in the standby mode, press **pb/rocket/**.
- 2) Press **+** or **-** to view the phonebook locations (see “Viewing the Phonebook” on page 27).
- 3) Press **talk/flash**. The displayed number is dialed.

```
Phonebook : 85  
Search [A-Z/↑/↓]  
Store [select]
```

From Talk Mode

- 1) Press **talk/flash**.
- 2) Press **pb/rocket/**.
- 3) Press **+** or **-** to view the phonebook locations (see “Viewing the Phonebook” on page 27).
- 4) Press **select/ch**. The number in the displayed phonebook location is dialed.

```
Phonebook : 85  
Search [A-Z/↑/↓]
```

Speed Dialing

If you select a speed dial memory location (10 locations: SPD1 – SPD0) when storing a phone number in the phonebook dial location, you can use the speed dialing feature. When the phone is in the standby mode, press and hold a number key (**0-9**) associated with the speed dial, then press **talk/flash**. The phone number in the speed dial (SPD1 – SPD0) is dialed.

Editing or Erasing a Stored Name, Phone Number, Distinctive Ring, and Speed Dial

- 1) When the phone is in the standby mode, press **pb/rocket/<**.
- 2) Press **+** or **-**, or the number keypad to view the phonebook locations (see “Viewing the Phonebook” on page 27).

```
Phonebook : 85
Search [A-Z/↑/↓]
Store [select]
```

a. Editing the Stored Data

- 1) When the phonebook location to be edited appears, press **select/ch**. “Store/Edit Name” appears.
- 2) Follow the steps 3 to 7 under “Storing Phone Numbers, Names, Distinctive Rings and Speed Dial” on page 24-25 to complete editing operation.
- 3) Press **select/ch**. You will hear a confirmation tone and “Done!” appears on the display.

```
Store/Edit Name
```

b. Deleting the Stored Data

- 1) When the phonebook location to be deleted appears, press **xfer/del**. “Delete Memory?” appears.
- 2) Press **+** to move the pointer to “Yes”.
- 3) Press **select/ch**. You hear a confirmation tone. “Deleted!” appears in the display.

```
Delete Memory?
Yes
No
```

```
Delete Memory?
Yes
No
```

```
Deleted!
```

RocketDial (One Touch Dialing)

You can store a number you dial often in the RocketDial. The rocket dialing allows you to dial a number with one key press.

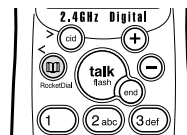

Memory location for the RocketDial is independent from the memory location for the phonebook.

Storing the RocketDial

- 1) When the phone is in the standby mode, press **pb/rocket/**.
- 2) Press - once to display the RocketDial menu, then press **select/ch**. Store the name, phone number, and distinctive ring by following the steps 3 to 6 under “Storing the Phone Numbers, Names, Distinctive Rings and Speed Dial” on page 24-25.

```
Phonebook : 85
Search [A-Z/↑/↓]
Store [select]
```

```
<Empty> /SD
```

Making calls with the RocketDial

When the phone is in the standby mode, press and hold **pb/rocket/**. The number in the rocket location is dialed.

```
-Talk-
8175551212
```

Deleting the RocketDial

- 1) When the phone is in the standby mode, press **pb/rocket/**.
- 2) Press - to display the RocketDial menu.
- 3) Press **xfer/del**.
- 4) Press + to move the pointer to “Yes”.
- 5) Press **select/ch**. You will hear a confirmation tone.

```
MOM AND DAD
817-555-1212
Flicker /SD
```

```
Delete Memory?
Yes
No
```

```
Delete Memory?
Yes
No
```

Chain Dialing

The memory locations in the handset are not limited to phone numbers. You can also store a group of numbers (up to 20 digits), that you need to enter once your call connects. This is referred to as Chain Dialing.

An example of this is a bank account number. Store the special number in the RocketDial (refer to “Storing Phone Numbers, Names, Distinctive Rings and Speed Dial” on page 24.). Once you have called your bank, and when you are prompted to enter the account number, press **pb/rocket/** and - to select the number in the RocketDial, then press **select/ch**.

Caller ID

You must subscribe to Caller ID service to use this feature.

When the telephone rings, the Caller ID feature allows you to view the caller's name and phone number on the display before you answer the phone. Additionally, you can dial the displayed number and store the information for memory dialing.

Make sure you have turned on the Caller ID/Call Waiting feature. (See page 15.)

Important:

Memory locations for Caller ID messages and Phonebook locations are common, you can store up to 100 in total. A Caller ID message is not stored when you have stored 100 of the phonebook locations. The earliest Caller ID message is overwritten when you have stored 100 of the phonebook locations and Caller ID messages in total.

note If you get an incoming call, a transferring call, or page, the operation is canceled.

- When the Caller ID message is received, the display shows the caller's name and phone number along with the date and time. The incoming call information is stored in the Caller ID record. If the Caller ID service includes the caller's name, the name will appear on the display. (up to 15 characters.)

The date and time received	12/12 12:30PM
Caller's name	Uniden Corp
Caller's phone number	800-297-1023

You may receive any one of the following messages:

When invalid data is received	"Incomplete Data"
When a private name is received	"Private Name"
When a private number is received	"Private Number"
When an unknown name is received	"Unknown Name"
When an unknown number is received	"Unknown Number"

- When you pick up the phone, the display changes to "Talk". (AutoTalk feature is set to On.)



- If you answer a call before the Caller ID message is received (Example: before the second ring), the Caller ID message will not appear.
- When the call is received via a telephone company that does not offer Caller ID service, the caller's phone number and name do not appear. (This includes some international calls.)
- When the call is via a private branch exchange (PBX), the caller's phone number and name may not appear.



- The number of calls from the same Caller ID appears next to the received time. Once you have reviewed the new message, the number will be cleared and disappears.
- If you press **end** while in the operation, the phone will return to the standby mode (or a call will be disconnected when you view the Caller ID list during a call).
- If you don't press a key within 30 seconds while in the operation, the phone will return to the standby mode (or back to a call when you view the Caller ID list during a call).

Viewing the Caller ID List

The Caller ID list stores information for incoming calls – even unanswered calls. You can store 100 of the Caller ID messages and phonebook locations (including Speed dials) in total. You can view the Caller ID list during a call or when the phone is in the standby mode.

- 1) Press **cid/>**.

The summary screen appears. The screen shows the number of new messages and the total number of messages.

Caller ID
New : 1
Total: 2

- 2) View Caller ID messages by following the procedure.

From new to old:

- a. Press - to display the latest Caller ID message.
- b. Press - to see the previous message.

From old to new:

- a. Press + to display the earliest Caller ID message.
- b. Press + to see the next message.

In alphabetic order:

Press the number keypad (**2-9** and **0**) to display the Caller ID messages in alphabetical order. Refer to the letters on the number keys to select the desired letter.



Once you view the Caller ID list in alphabetical order, you cannot switch to the Caller ID display in historical order (from new to old or from old to new) unless you exit the operation.

- 3) Press **cid/>** (if you view the Caller ID list during a call) or **end**.

Deleting Information from the Caller ID List

Deleting a Caller ID message

- 1) While the incoming Caller ID information is displayed, press *xfer/del*.

"Delete Message?" appears.

```

Delete Message?
└─ Yes
  No
  
```

- 2) Press + or - to choose "Yes" or "No".

- 3) Press *select/ch* or *xfer/del*.

When the pointer is at "Yes": A tone sounds and the Caller ID message is deleted. The next or previous Caller ID message is then displayed.

When the pointer is at "No": The display returns to the Caller ID message.

Deleting all Caller ID names/numbers

- 1) Press *cid/>*.

```

Caller ID
New : 1
Total: 2
  
```

- 2) Press *xfer/del*.

- 3) Press + or - to choose "Yes" or "No".

```

Delete All?
└─ Yes
  No
  
```

- 4) Press *select/ch* or *xfer/del*.

When the pointer is at "Yes": A tone sounds and all stored Caller ID messages are deleted.

When the pointer is at "No": The display returns to the summary screen.



- You cannot make a call from the Caller ID list if your phone is connected to a private branch exchange (PBX).
- When a long distance call has been set, “1” appears in the display.
- If a call comes in via a telephone system that does not offer Caller ID service, no information is stored.

Using the Caller ID Message List

Calling a party from the Caller ID list

From Standby mode

- 1) Press **cid/**>. The summary screen appears. The screen shows the number of new messages and the total number of messages.
- 2) Use the number keypad (**2-9** and **0**), **+**, or **-** to view the Caller ID message list.
- 3) Press **talk/flash**. The displayed phone number dials automatically.

```
Caller ID
New : 1
Total: 2
```

From Talk mode

- 1) Press **talk/flash**.
- 2) Press **cid/**>. The summary screen appears.
- 3) View the Caller ID message you want to dial.
- 4) Press **select/ch**. The displayed phone number will be dialed.

```
-Talk-
8002971023
```

Long Distance calls and Area Code Setting/Cancellation

While the incoming Caller ID information is displayed, pressing ***tone** will place or remove the prefix “1” in the display to set the call for a long distance call, or pressing **#** will set or cancel an area code. (See page 16.)

Storing Caller ID messages in the Phonebook/RocketDial

Messages shown in the Caller ID list can be stored in the phonebook. Using the incoming call information (i.e., Caller ID list), the phone number of the party on the Caller ID list can be stored in memory.

- 1) When the phone is in the standby mode, while the incoming Caller ID information is displayed, press **pb/rocket/**<.
- 2) Press **+** or **-** to choose “Store in PB?” (Phonebook locations) or “Store in SD?” (RocketDial location). To cancel Storing, select “Cancel”.

```
12/12 12:30PM
Uniden Corp
800-297-1023
```

```
► Store in PB?
Store in SD?
Cancel
```

3) Press **select/ch**. You will hear a confirmation tone.



- You cannot store a Caller ID message in the phonebook if a phone number does not appear in the message.
- You cannot set the distinctive ring or speed dial in this step. If you would like to set these options, edit the stored data.
- Even if the memory locations are full, the message will be stored in the Phonebook, however, the message will be erased from the Caller ID List.
- If data is already stored in the RocketDial, the old data will be overwritten by the new data.

Call Waiting Deluxe Features

Your TRU4060-2 gives you new options for call waiting. At the touch of a button, you can place the caller on hold, send them to your voice mail service, or conference them into your current call. You may be required to subscribe to Call Waiting and Call Waiting Deluxe to use these features. Not all features are available in all areas. Check with your local telephone company for details.

- 1) When you receive a call waiting call, press **menu/mute** for a list of options.
- 2) Press **+** or **-**, or the number keypad (**1 - 7**) to select an option. For example:

```

1▶ Ask to Hold
2 Tell Busy
3 Forward Call
  
```

- 4times

```

3 Forward Call
4 Answer/Drop 1
5▶ Conference
  
```

- 2times

```

5 Conference
6 Drop First
7▶ Drop Last
  
```

3) Press **select/ch**. A confirmation screen will appear.

Your TRU4060-2 is pre-programmed with seven call waiting options. You may select to ask the calling party to hold, send them a busy message, forward them to your voice mail, or answer and drop the first caller. You may also select to conference them into the current call or, at any time, choose to drop the first or drop the last caller.

Check with your local telephone company for a full list of options.



- To activate features, select "CW Deluxe On" in the Caller ID setup. See page 15.
- You can also answer a waiting call immediately by pressing **talk/flash**, the first caller will be placed on hold. To return to the original caller, press **talk/flash** again.

Expanding Your Phone

Your phone supports up to 2 handsets (the original handset and the second handset). You can now place a fully featured cordless handset anywhere AC power is available to connect the handset charger. Additionally, you can transfer an outside call to another handset.



- We refer to the handset No.2 as the second handset, and the handset No.1 as the original handset in this section.
- Before use, you need to charge the battery pack for at least 15-20 hours.

How to Distinguish the Original Handset and the Second Handset

The original handset and second handset are identical in appearance. To distinguish the original and second handset, charge the handset on the base. If you charge the second handset, HS2 appears, otherwise HS1 appears. There are some restrictions on the second handset, see “Second Handset Operation” on page 38.

Registering the Second Handset

You will need to register the second handset each time you change the digital security code of the original unit. To register the second handset, simply place the second handset in the original base for at least 5 seconds. The **status** LED on the original base will flash indicating that registration is occurring. After 5 seconds, the second handset will be registered.

Call Transfer Feature

Call Transfer allows you to transfer outside calls from handset to handset, only one handset at a time can talk with an outside caller.

note If you transfer the call and it is not picked up after 5 minutes, the call will be disconnected.

To transfer a call (to the second handset)

- 1) Press ***xfer/del*** during a call. The call will automatically be placed on hold and the transfer tone sounds.
- 2) When the other handset receives the call, the transfer tone stops. To cancel the transfer, press ***xfer/del*** or ***talk/flash*** on the handset.

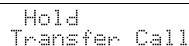

Hold
Transfer Call

To receive a transferred call (from the second handset)

Pick up a handset (when AutoTalk is set to On), or press ***talk/flash*** to answer the transferred call. Additionally, you can answer the transferred call by pressing any number key, ****tone***, or ***#*** (when AutoTalk is set to On).

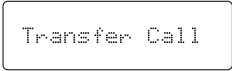

Transfer Call

Second Handset Operation

Setting up

Charging

- Charge the second handset for 15-20 hours before using.
- When you charge the second handset, the display shows the name of the handset, HS2.

Dialing mode

Dialing mode is a universal setting. When the mode is changed on the original handset, the setting for the second handset is changed as well.

CIDCW

- CIDCW setting is a universal setting. When the setting is changed on the original handset, the CIDCW setting for the second handset is changed as well.
- CW Deluxe setting is independent from the original handset. To set the CW Deluxe setting on the second handset, do the following.
 - 1) When the phone is in the standby mode, press **menu/mute**.
 - 2) Press - or + to move the pointer to "Caller ID Setup", then press **select/ch**.
 - 3) Press - or + to select "CW Deluxe", then press **select/ch**.
 - 4) Press - or + to select "CW Deluxe On" to active CW Deluxe features, then press **select/ch**.

Operation

Making and receiving calls

If you press *talk/flash* on the handset while the other handset is in use, you will hear a beep and the handset will return to the standby mode.

Security code

You can change the digital security code, only from the original handset.

Memory locations (Redial memory/Dynamic memory locations)

Memory locations in the original handset and the second handset are independent.

Page

If you press any key on a handset while paging, the paging sound from the other handset will stop as well.

Caller ID

- When you receive a CIDCW during a call, the Caller ID information will not be displayed or stored in the other handset.
- To display CIDCW on the second handset, you must turn On the CIDCW or CW Deluxe on the original unit.

Others

You can't purchase the second handset as an alternative of the original handset.

Changing the Digital Security Code

The digital security code is an identification code used to connect the handset and the base unit. Normally, setting the code is not necessary. The first time you charge your handset, the security code is automatically set. (See “About the digital security code”, page 8.) In the rare situation that you suspect another cordless telephone is using the same security code, you can change the code. To change the digital security code, deregister the code, then register a different code.

Deregister the Digital Security Code

- 1) Remove the handset from the base. In the standby mode, press and hold **xfer/del** and **end** for 10 seconds. You will hear a confirmation tone. “De-Register?” appears.
- 2) Press **+** to select “Yes”, then **select/ch**. You will hear a confirmation tone, and “Deregistration Complete” appears.



- If you have not pressed any key for 30 seconds while in the deregistering operation, the phone returns to the standby mode.
- While in the deregistering operation, if you receive an incoming call, page, or transferring call, or charge the handset, or press **talk/flash** or **end**, the operation is canceled and the phone will return to the standby mode.

Register the Security Code

- 1) Unplug the AC adapter.
- 2) Press and hold **find handset** on the base while you plug in the AC Adapter until the **status** LED on the base flashes.
- 3) Press **talk/flash**. "Handset Registering" appears.

When the operation is finished "Registration Complete" appears and the **status** LED is turned Off. You will hear a confirmation tone and the phone returns to the standby mode.



- You must complete the registration operation within 30 seconds, or the phone returns to standby mode.
- During the registration operation, you cannot receive an incoming call, page, or make a call.

Installing the Beltclip

To attach the beltclip

Insert the beltclip into the holes on each side of the handset. Press down until it clicks.

To remove the beltclip

Pull both sides of the beltclip to release the tabs from the holes.

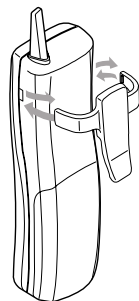

Headset Installation

Your phone may be used with an optional headset, the Uniden HS910. To use this feature, insert the headset plug into the headset jack. Your phone is ready for hands-free conversations. (Headset may be purchased by calling the Uniden Parts Department or visiting the web site. See Page 9.)

Note on Power Sources

Battery replacement and handling

When the operating time becomes short, even after a battery is recharged, please replace the battery. With normal usage, your battery should last about one year.

Please contact your place of purchase or the Uniden Parts Department for a replacement battery. (See page 9)

Warning:

To avoid the risk of personal injury or property damage from fire or electrical shock, only use the Uniden battery model and Uniden adapter model specifically designated for this product.

Power Failure

During the period that the power is off, you will not be able to make or receive calls with the telephone.

Caution

- Use the specified Uniden battery pack (BT-446).
- Do not remove the battery from the handset to charge it.
- Never throw the battery into a fire, disassemble it, or heat it.
- Do not remove or damage the battery casing.

Maintenance

When slightly dirty

Wipe with a soft, dry cloth.

When very dirty

Wipe with a soft cloth that has been dampened with diluted, neutral detergent. Dry with a dry cloth.

When the charging terminals become dirty

Wipe with a dry cloth or a pencil eraser, if necessary.

Caution

Do not use paint thinner, benzene, alcohol, or other chemical products. Doing so may discolor the surface of the telephone and damage the finish.

General Information

The phone complies with FCC Parts 15 and 68. Operating temperature: 0 °C to +50 °C (+32 °F to +122 °F)

AC Adapter Information

AC Adapter part number:	AD-312 for the base	AD-446 for the charger
Input Voltage:	120V AC 60Hz	120V AC 60Hz
Output Voltage:	9V DC 350 mA	9V DC 210 mA

Battery Information

Battery part number:	BT-446
Capacity:	800 mAh, 3.6V
Battery use time (per charge) From fully charged	
Talk mode duration:	6 hours
Standby mode duration:	10 days



If the handset is left off of the base, the actual Talk mode duration will be reduced respective to the amount of time the handset is off the base.

Recharge your phone on a regular basis by returning the handset to the base after each phone call. When the operating time becomes short, even after the battery is recharged, please replace the battery. With normal usage, the battery should last about one year.

A replacement Uniden adapter and battery may be purchased at your local Uniden dealer or by contacting the Uniden Parts Department (800) 554-3988. Hours are from 7:00 a.m. to 5:00 p.m. CST, Monday through Friday. We can also be reached on the web at www.uniden.com.

Specifications, features, and availability of optional accessories are all subject to change without prior notice.

Troubleshooting

If your phone is not performing to your expectations, please try these simple steps first.

Symptom	Suggestion
The status LED won't illuminate when the handset is placed in the base.	<ul style="list-style-type: none">• Make sure the AC adapter is plugged into the base and wall outlet.• Make sure the handset is properly seated in the base.• Make sure the charging contacts on the handset and base are clean.
The audio sounds weak and/or scratchy.	<ul style="list-style-type: none">• Move the handset and/or base to a different location away from metal objects or appliances and try again.• Press select/ch to help eliminate background noise.• Make sure that you are not too far from the base.
Can't make or receive calls.	<ul style="list-style-type: none">• Check both ends of the base telephone line cord.• Make sure the AC adapter is plugged into the base and wall outlet.• Disconnect the AC adapter for a few minutes, then reconnect it.• Change the digital security code (See page 40).• Make sure that you are not too far from the base.
The handset doesn't ring or receive a page.	<ul style="list-style-type: none">• The battery pack may be weak. Charge the battery on the base unit for 15-20 hours.• The handset may be too far away from the base unit.• Place the base unit away from appliances or metal objects.• Change the digital security code (See page 40).
Severe noise interference.	<ul style="list-style-type: none">• Keep the handset away from microwave ovens, computers, remote control toys, wireless microphones, alarm systems, intercoms, room monitors, fluorescent lights, and electrical appliances.• Move to another location or turn off the source of interference.
The Caller ID does not display.	<ul style="list-style-type: none">• The handset was picked up before the second ring.• The call was placed through a switchboard.• Call your local telephone company to verify your Caller ID service is current.• Charge the handset.
The handset doesn't communicate with the base or the other handset.	<ul style="list-style-type: none">• Change the digital security code (See page 40).
The second handset can't join the conversation.	<ul style="list-style-type: none">• Only one handset at a time can talk with an outside caller. To allow a different handset to talk to the caller, transfer the call to the other handset.
If you still have a problem.	<ul style="list-style-type: none">• Call our customer hotline at 1-800-297-1023.

Precautions!

Before you read anything else, please observe the following:

Warning!

Uniden America Corporation DOES NOT represent this unit to be waterproof. To reduce the risk of fire, electrical shock, or damage to the unit, DO NOT expose this unit to rain or moisture.

Rechargeable Nickel-Metal-Hydride Battery Warning

- This equipment contains a rechargeable Nickel-Metal-Hydride battery.
- Nickel is a chemical known to state of California to cause cancer.
- The rechargeable Nickel-Metal-Hydride battery contained in this equipment may explode if disposed of in a fire.
- Do not short-circuit the battery.
- Do not charge the rechargeable Nickel-Metal-Hydride battery used in this equipment in any charger other than the one designed to charge this battery as specified in the owner's manual. Using another charger may damage the battery or cause the battery to explode.

Rechargeable Nickel-Metal-Hydride Batteries Must Be Recycled or Disposed of Properly



The exclamation point within an equilateral triangle is intended to alert the user to the presence of important operating and maintenance (servicing) instructions in the literature accompanying the appliance.

Important Safety Instructions

When using your telephone equipment, these basic safety precautions should always be followed to reduce the risk of fire, electrical shock, and injury to persons:

1. Read and understand all instructions.
2. Follow all warnings and instructions marked on the product.
3. Unplug this product from the wall outlet before cleaning. Use a dry cloth for cleaning without liquid or aerosol cleaners.
4. Do not use this product near water; for example, near a bathtub, wash bowl, kitchen sink or laundry tub, in a wet basement, or near a swimming pool.
5. Do not place this product on an unstable cart, stand, or table. The telephone may fall, causing serious damage to the unit.
6. Slots and openings in the cabinet and the back or bottom are provided for ventilation. To protect the product from overheating, these openings must not be blocked or covered. This product should never be placed near or over a radiator or heat register. This product should not be placed in a built-in installation unless proper ventilation is provided.
7. This product should be operated only from the type of power source indicated on the marking label. If you are not sure of the type of power supply to your home, consult your dealer or local power company.
8. Do not allow anything to rest on the power cord. Do not locate this product where the cord will be damaged by persons walking on it.
9. Do not overload wall outlets and extension cords, as this can result in the risk of fire or electrical shock.
10. Never push objects of any kind into this product through cabinet slots, as they may touch dangerous voltage points or short out parts that could result in a risk of fire or electric shock. Never spill liquid of any kind on the product.
11. To reduce the risk of electric shock, do not disassemble this product. Take it to qualified service personnel when service or repair work is required. Opening or removing covers may expose you to dangerous voltages or other risks. Incorrect reassembly can cause electric shock when the appliance is subsequently used.
12. Unplug this product from the wall outlet and refer servicing to qualified service personnel under the following conditions:
 - A. When the power supply cord is damaged or frayed.
 - B. If liquid has been spilled into the product.
 - C. If the product has been exposed to rain or water.
 - D. If the product does not operate normally when following the operating instructions. (Adjust only those controls that are covered by the operating instructions. Improper adjustment of other controls may result in damage and will often require extensive repair work by a qualified technician.)
 - E. If the product has been dropped or the cabinet has been damaged.
 - F. If the product exhibits a distinct change in performance.
13. Do not use the telephone to report a gas leak in the vicinity of the leak.

Additional Battery Safety Precautions

Caution! To reduce the risk of fire or injury to persons by the battery, read and follow these instructions:

1. Use only the Uniden battery pack specified in the owner's manual.
2. Do not dispose of the battery pack in a fire. The cell may explode. Check the Nickel Metal Hydride battery disposal package insert for disposal instructions.
3. Do not open or mutilate the battery pack. Released electrolyte is corrosive and may cause damage to the eyes or skin. It may be toxic if swallowed.
4. Exercise care in handling the battery in order not to short the battery with conducting materials such as rings, bracelets, and keys. The battery or conductor may overheat and cause burns.
5. Charge the battery pack provided with or identified for use with this product only in accordance with the instructions and limitations specified in the owner's manual provided for this product.
6. Observe proper polarity orientation between the battery pack and battery charger.

SAVE THESE INSTRUCTIONS!

Important Electrical Considerations

Unplug all electrical appliances when you know an electrical storm is approaching. Lightning can pass through your household wiring and damage any device connected to it. This phone is not an exception.

Warning!

Please do not attempt to unplug any appliance during an electrical storm.

The FCC Wants You To Know

Changes or modifications to this product not expressly approved by Uniden, or operation of this product in any way other than as detailed by the owner's manual, could void your authority to operate this product. The equipment cannot be used on public coin phone service provided by the telephone company. Connection to party line service is subject to state tariffs. (Contact the state public utility commission, public service commission or corporation commission for information.)

Range

Your new phone is designed to achieve the maximum possible range by transmitting and receiving according to the highest specifications set forth by the FCC. We have rated this phone to operate at a maximum distance with the qualification that the range depends upon the environment in which the telephone is used. Many factors limit range, and it would be impossible to include all the variables in our rating. The Maximum Range rating of this phone is meant to be used as a means of comparison against other range claims.

Telephone Line Problems

The FCC has granted the telephone company the right to disconnect service in the event that your phone causes problems on the telephone line. Also, the telephone company may make changes in facilities and services which may affect the operation of your unit. However, your telephone company must give adequate notice in writing prior to such actions to allow you time for making necessary arrangements to continue uninterrupted service.

If you are having trouble with your telephone service, you must first disconnect your phone to determine if it is the cause of your problem. If you determine that it is the cause, you must leave it disconnected until the trouble has been corrected.

Radio Interference

Radio interference may occasionally cause buzzing and humming in your cordless handset, or clicking noises in the base. This interference is caused by external sources such as TV, refrigerator, vacuum cleaner, fluorescent lighting, or electrical storm. Your unit is NOT DEFECTIVE. If these noises continue and are too distracting, please check around your home to see what appliances may be causing the problem. In addition, we recommend that the base not be plugged into a circuit that also powers a major appliance because of the potential for interference. Be certain that the antenna on the unit is fully extended when needed. In the unlikely event that you consistently hear other voices or distracting transmissions on your phone, you may be receiving radio signals from another cordless telephone or other source of interference. If you cannot eliminate this type of interference, you need to change to a different channel.

Finally, it should be noted that some cordless telephones operate at frequencies that may cause interference to nearby TVs and VCRs. To minimize or prevent such interference, the base of the cordless telephone should not be placed near or on top of a TV or VCR. If interference is experienced, moving the cordless telephone farther away from the TV or VCR will often reduce or eliminate the interference.

More than One Cordless Telephone

If you want to use more than one cordless telephone in your home, they must operate on different channels. Press the channel key to select a channel that provides the clearest communication.

Cordless Telephone Privacy

Cordless telephones are radio devices. Communications between the handset and base of your cordless telephone are accomplished by means of radio waves which are broadcast over the open airways. Because of the inherent physical properties of radio waves, your communications can be received by radio receiving devices other than your own cordless telephone unit. Consequently, any communications using your cordless telephone may not be private.

Installation Considerations

Selecting a Location

Before choosing a location for your new phone, there are some important guidelines you should consider:

- The location should be close to both a phone jack and continuous power outlet. (A continuous power outlet is an AC outlet which does not have a switch to interrupt its power.)
- Keep the base and handset away from sources of electrical noise such as motors or fluorescent lighting.
- Be sure there is sufficient space to fully extend the base antenna.
- The base can be placed on a desk or tabletop or mounted on a standard telephone wall plate.
- You should charge your new phone for 15-20 hours before completing the installation or using the handset.

Telephone Line Outlets

There are two types of phone outlets:

Modular Jack

Most phone equipment available now uses modular jacks. Phone cords are fitted with a molded plastic connector which plugs into this type of jack. If you do not have modular phone jacks, contact your local telephone company for information about their installation.

Hardwired Jack

Some equipment is wired directly to a phone jack, and these types of installations require a modular jack converter. This type of installation is not difficult; however, you should contact your Uniden telephone dealer or a telephone supply store for advice about the proper adapter or converter for your particular situation.

Connecting the Telephone Cords

Consider these safety guidelines before connecting the telephone cords:

Caution!

- Never install telephone wiring during a lightning storm.
- Never touch uninsulated telephone wires or terminals unless the telephone line has been disconnected.
- Use caution when installing or modifying telephone lines.

Applying Power to the Base

This phone requires an AC outlet, without a switch to interrupt power, and the included AC adapter. To relieve strain on the DC plug when the phone is placed on a desk or table, wrap the power cord around the strain relief notch on the bottom of the base.

NOTE: Place the power cord so that it does not create a trip hazard, or where it could become chafed and create a fire or other electrical hazards.

Plug the AC Adapter into a standard 120 VAC wall outlet.

Do not use an outlet controlled by a wall switch.



Use only the Uniden AC Adapter supplied with this phone.

One Year Limited Warranty

Important: Evidence of original purchase is required for warranty service.

WARRANTOR: UNIDEN AMERICA CORPORATION ("Uniden")

ELEMENTS OF WARRANTY: Uniden warrants, for one year, to the original retail owner, this Uniden Product to be free from defects in materials and craftsmanship with only the limitations or exclusions set out below.

WARRANTY DURATION: This warranty to the original user shall terminate and be of no further effect 12 months after the date of original retail sale. The warranty is invalid if the Product is (A) damaged or not maintained as reasonable or necessary, (B) modified, altered, or used as part of any conversion kits, subassemblies, or any configurations not sold by Uniden, (C) improperly installed, (D) serviced or repaired by someone other than an authorized Uniden service center for a defect or malfunction covered by this warranty, (E) used in any conjunction with equipment or parts or as part of any system not manufactured by Uniden, or (F) installed or programmed by anyone other than as detailed by the owner's manual for this product.

STATEMENT OF REMEDY: In the event that the product does not conform to this warranty at any time while this warranty is in effect, warrantor will either, at its option, repair or replace the defective unit and return it to you without charge for parts, service, or any other cost (except shipping and handling) incurred by warrantor or its representatives in connection with the performance of this warranty. Warrantor, at its option, may replace the unit with a new or refurbished unit. THE LIMITED WARRANTY SET FORTH ABOVE IS THE SOLE AND ENTIRE WARRANTY PERTAINING TO THE PRODUCT AND IS IN LIEU OF AND EXCLUDES ALL OTHER WARRANTIES OF ANY NATURE WHATSOEVER, WHETHER EXPRESS, IMPLIED OR ARISING BY OPERATION OF LAW, INCLUDING, BUT NOT LIMITED TO ANY IMPLIED WARRANTIES OF MERCHANTABILITY OR FITNESS FOR A PARTICULAR PURPOSE. THIS WARRANTY DOES NOT COVER OR PROVIDE FOR THE REIMBURSEMENT OR PAYMENT OF INCIDENTAL OR CONSEQUENTIAL DAMAGES. Some states do not allow this exclusion or limitation of incidental or consequential damages so the above limitation or exclusion may not apply to you.

LEGAL REMEDIES: This warranty gives you specific legal rights, and you may also have other rights which vary from state to state. This warranty is void outside the United States of America.

PROCEDURE FOR OBTAINING PERFORMANCE OF WARRANTY: If, after following the instructions in the owner's manual you are certain that the Product is defective, pack the Product carefully (preferably in its original packaging). The Product should include all parts and accessories originally packaged with the Product. Include evidence of original purchase and a note describing the defect that has caused you to return it. The Product should be shipped freight prepaid, by traceable means, to warrantor at:

Uniden America Corporation
Parts and Service Division
4700 Amon Carter Blvd.
Fort Worth, TX 76155

(800) 297-1023, 8 a.m. to 5 p.m. CST, Monday through Friday

I.C. Notice

TERMINAL EQUIPMENT

NOTICE: This equipment meets the applicable Industry Canada Terminal Equipment Technical Specifications. This is confirmed by the registration number. The abbreviation, IC, before the registration number signifies that registration was performed based on a Declaration of Conformity indicating that Industry Canada technical specifications were met. It does not imply that Industry Canada approved the equipment.

NOTICE: The Ringer Equivalence Number (REN) for this terminal equipment is marked on the equipment itself. The REN assigned to each terminal equipment provides an indication of the maximum number of terminals allowed to be connected to a telephone interface. The termination on an interface may consist of any combination of devices subject only to the requirement that the sum of the Ringer Equivalence Numbers of all the devices does not exceed five.

RADIO EQUIPMENT

The term “IC:” before the radio certification number only signifies that Industry Canada technical specifications were met.

Operation is subject to the following two conditions: (1) this device may not cause interference, and (2) this device must accept any interference, including interference that may cause undesired operation of the device. “Privacy of communications may not be ensured when using this telephone”.

Index

0 - 9

10 ring options20

A

Area Code16

AutoTalk15

B

Battery pack

 Preparing and charging11

 Replacement and handling42

Beltclip41

C

Caller ID31

 Caller ID service31

 Calling34

 Call Waiting15, 35

 Deleting33

 Setting15

 Storing34

 Using34

 Viewing.....32

Call transfer feature37

Chain dialing30

Channel23

D

Deluxe Call Waiting Features35

Dialing mode14

Digital security code8, 40

Distinctive Ringer21

E, F, G, H

Earpiece volume21

General information43

Headset installation41

I, J, K, L

I.C. Notice47

Important Safety Instructions45

Language17

M, N, O

Maintenance42

Making a call18

Mute22

One touch dialing29

P, Q

Package contents9

Phonebook24

 Editing29

 Erasing29

 Making calls28

 Storing24

 Viewing.....27

Precautions45

R

Receiving a call18

Redialing a call19

Registering the second handset36

Ring volume20

RocketDial29

S

Second handset operation38

Setting up.....10

 Base unit13

 Handset11

Speed dialing.....28

T, U, V, W, X, Y, Z

Transferring a call.....37

 Receive from the second handset37

 Transfer to the second handset37

Troubleshooting44

Voice Mail LED23

Warranty46

At Uniden, we'll take care of you!

If you need any assistance with this product, please call our Customer Hotline at

1-800-297-1023

PLEASE DO NOT RETURN THIS PRODUCT TO THE PLACE OF PURCHASE.

Our Uniden representatives will be happy to help you with any matters regarding the operation of this unit, available accessories, or any other related matters.

Thank you for purchasing a Uniden product.
Hours: M-F 8:00 AM to 5:00 PM CST.



For information on the accessibility features of this product, please call

1-800-874-9314 (V/TTY)

The Uniden logo is displayed in a bold, black, sans-serif font. The letter 'i' in 'Uniden' has a distinctive dot that is a small circle. A registered trademark symbol (®) is located at the top right of the 'n'.

May be covered under one or more of the following U.S. patents:

4,511,761	4,523,058	4,595,795	4,797,916	5,381,460	5,426,690
5,434,905	5,491,745	5,533,010	5,543,605	5,574,727	5,581,598
5,650,790	5,660,269	5,661,780	5,663,981	5,671,248	5,696,471
5,717,312	5,732,355	5,754,407	5,758,289	5,768,345	5,787,356
5,794,152	5,801,466	5,825,161	5,838,721	5,864,619	5,893,034
5,912,968	5,915,227	5,929,598	5,930,720	5,960,358	5,987,330
6,044,281	6,070,082	6,125,277	6,253,088		

©2002 Uniden America Corporation, Fort Worth, Texas
Contains additional foreign articles.

Custom manufactured in China.

UCZZ01784MZ