

**Uniden** | A World Without Wires®

UNIDEN  
CORDLESS  
PHONES



# TRU12803 Series

**OWNER'S MANUAL**

# Table of Contents

<b>Welcome</b> .....	<b>4</b>
Accessibility .....	4
Manual Conventions .....	5
Terminology Used in this Manual .....	5
<b>Product Overview</b> .....	<b>6</b>
Features:.....	6
Answering System Features:.....	6
Parts of the Phone .....	7
<b>Using the Interface</b> .....	<b>9</b>
Reading the Display.....	9
Using the Four-way Function Key.....	10
Using the Handset Menus .....	10
Entering Text from Your Handset .....	11
<b>Installing the Phone</b> .....	<b>12</b>
Choosing the Best Location .....	12
Installing the Battery .....	13
Connecting the Base and Charging the Handset ..	14
Connecting the Charger and Charging the Handset (Multi-handset packs only) .....	14
Connecting to the Phone Line .....	15
Testing the Connection .....	15
Changing the Dial Mode .....	16

<b>Basic Setup</b> .....	<b>17</b>
Selecting a Language .....	17
Activating Personal Ring.....	17
Activating the Key Touch Tone.....	18
<b>Setting Up the Phonebook</b> .....	<b>19</b>
Creating Phonebook Entries.....	19
Finding a Phonebook Entry .....	20
Editing an Existing Phonebook Entry.....	20
Storing Caller ID or Redial Numbers in the Phonebook.....	21
Deleting Phonebook Entries .....	21
Copying Phonebook Entries to Another Handset (Multi-handset packs only).....	22
<b>Customizing Your Phone</b> .....	<b>23</b>
Selecting a Ring Tone (Handset only).....	23
Activating AutoTalk (Handset only) .....	24
Activating Any Key Answer (Handset only) .....	24
<b>Using Your Phone</b> .....	<b>25</b>
Making a Call from the Phonebook.....	26
Chain Dialing from the Phonebook .....	26
Switching to the Handset Speakerphone During a Call .....	26

<b>Using Caller ID, Call Waiting, and Redial Lists.....</b>	<b>27</b>	<b>Setting Up the Answering System .....</b>	<b>36</b>
Using the Caller ID List .....	27	Features.....	36
Making a Call from a Caller ID Record .....	27	Using the Answering System Interface .....	37
Deleting Caller ID Numbers .....	28	Selecting the Language .....	37
Using Call Waiting.....	28	Setting the Number of Rings.....	38
Redialing a Number .....	29	Setting the Day & Time .....	38
Deleting a Redial Record .....	29	Recording a Personal Greeting .....	39
<b>Adjusting the Ringer, Earpiece and Speaker Volume ...</b>	<b>30</b>	Selecting a Greeting .....	39
Adjusting the Ringer Volume .....	30	Deleting Your Personal Greeting .....	40
Adjusting the Earpiece Volume .....	30	Setting the Record Time (or Announce only) .....	40
Adjusting the Speaker Volume.....	30	Activating the Message Alert .....	41
Adjusting the Audio Tone .....	31	Activating Call Screening.....	41
Using the Clarity Boost Feature.....	31	Setting a Security Code or Personal Identification Number (PIN) .....	41
<b>Finding a Lost Handset.....</b>	<b>31</b>	<b>Using the Answering System .....</b>	<b>42</b>
<b>Using Conference and Transfer (Multi-handset packs only) .....</b>	<b>32</b>	Turning Your Answering System On and Off .....	42
Conferencing .....	32	Reviewing Messages .....	43
Transferring a Call .....	32	Screening Calls.....	44
Answering a Transferred Call .....	32	Turning Off the Message Alert Tone.....	44
<b>Using Special Features .....</b>	<b>33</b>	Operating the Answering System While You Are Away from Home .....	45
Muting the Ringer (One call only) .....	33	<b>Maintenance.....</b>	<b>47</b>
Muting the Microphone .....	33	Specifications.....	47
Privacy Mode .....	33	Battery Replacement and Handling .....	48
Seven-Digit Dialing .....	34	Cleaning the Battery Contacts .....	48
Using the Intercom (Multi-handset packs only).....	34	Low Battery Alert .....	49
Tone Dialing Switch Over.....	35	Talk and Standby Times.....	49

<b>Troubleshooting .....</b>	<b>50</b>
Changing the Digital Security Code .....	50
Traveling Out of Range .....	51
Common Issues .....	52
Liquid Damage .....	54
<b>Precautions! .....</b>	<b>55</b>
Rechargeable Nickel-Metal-Hydride Battery Warning ...	55
The FCC Wants You To Know .....	56
I.C. Notice .....	57
<b>One Year Limited Warranty .....</b>	<b>58</b>
<b>Index .....</b>	<b>59</b>
<b>Remote Operation Card .....</b>	<b>64</b>
<b>At Uniden, we'll take care of you! .....</b>	<b>66</b>

## Welcome

Thank you for purchasing a Uniden cordless telephone.

Note: Illustrations in this manual are used for explanation purposes. Some illustrations in this manual may differ from the actual unit.

Uniden is a registered trademark of Uniden America Corporation. AutoStandby, DirectLink, IntegriSound and Random Code are trademarks of Uniden America.

## Accessibility

Uniden provides a customer service hotline for accessibility questions. If you have a disability and need customer service assistance or if you have any questions about how Uniden's products can accommodate persons with disabilities, please call the accessibility voice/TTY line: 1-800-874-9314

Our customer care hours as well as accessibility information can be found on our website, [www.uniden.com](http://www.uniden.com), under the "Accessibility" link. If your call is received outside of our business hours, you can leave us a message and we will call you back.

## Terminology Used in this Manual

<b>Standby</b>	The handset is not in use. If the handset is on the cradle or <b>[flash]</b> or <b>[MUTE]</b> on the handset is not pressed, no line has been activated. No dial tone is present.
<b>CID</b>	Caller ID is available from your Telephone provider and is offered to users on a subscription basis. With this service and a display on your cordless phone, you will be able to see the incoming caller information such as name and phone number.
<b>CID/CW or CIDCW</b>	Caller ID with Call Waiting is available by subscription from your Telephone provider. With this service, you will be able to view incoming caller information while on a call with another user. This will allow you the ability to select to talk to this user and put your existing party on hold or make the decision to ring them back.
<b>Base</b>	The main part of the phone that connects to your phone line and lets you make and receive calls.
<b>Charger</b>	A cradle that comes with an accessory handset (Multi-handset packs only) and charges the handset battery. It connects to power but does not connect to a phone line.
<b>Global settings</b>	Global Settings apply to all registered handsets. If you change something under the global menu, you change it for all handsets. Only one handset can change global settings at a time, and you have to make sure the phone is not currently being used.
<b>Talk</b>	A telephone line has been activated on the handset or base, enabling a dial tone.

## Manual Conventions

This manual uses several different type styles to help you distinguish between different parts of the phone:

- **lower case bold** text with “[ ]” indicates a key or button on the phone
- ALL CAPITALS indicates text on the display, such as menu options, prompts, and confirmation messages
- **lower case bold** text indicates a status light on the phone base

# Product Overview

## Features:

- 5.8GHz FHSS System
- Integrated Digital Answering Machine
- Caller ID/Call Waiting
- Store 30 Caller ID Numbers
- Advanced Phonebook Features:
  - Store 70 Phonebook Entries
  - Alphabetical Search
  - Personalized Ring by Party
  - Transfer Single Listing or Entire Phonebook (Multi-handset packs only)
- Speakerphone on Handset
- 7 Ringer Options on Handset (3 Tones/4 Melodies)
- Last 5 Number Redial
- Bilingual Menu Displays  
(for USA models: English and Spanish,  
for Canadian models: English and French)
- Call Transfer (Multi-handset packs only)
- Conferencing (Multi-handset packs only)
- Intercom (Multi-handset packs only)

## Answering System Features:

- Digital Tapeless Recording
- Up to 14 Minutes of Recording Time
- Call Screening
- Personal or Pre-recorded Outgoing Messages
- Bilingual Voice Prompts  
(for USA models: English and Spanish,  
for Canadian models: English and French)
- Day and Time Announcement
- Remote Message Retrieval
- Toll Saver
- Message Alert
- Records Up to 59 messages

## Parts of the Phone

The following illustrations show you all of the different parts of your phone.

### Handset

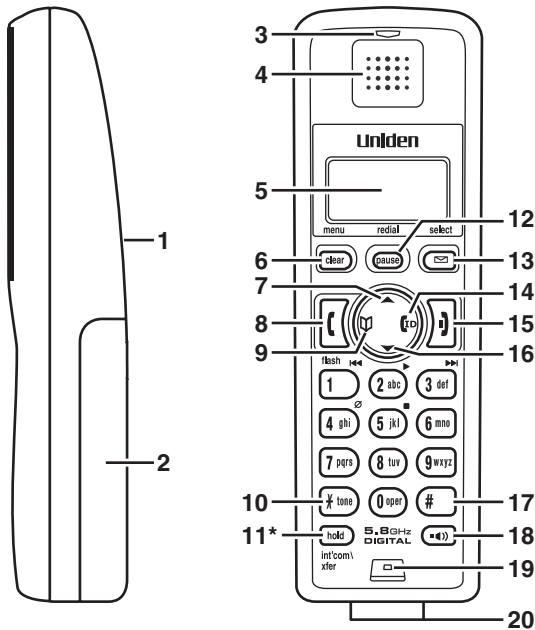

1. Speakerphone Speaker and Ringer
2. Handset Battery Compartment
3. New Message LED
4. Handset Earpiece
5. LCD Display
6. **[menu/clear]** key
7. **[▲]** key (up)
8. **[/flash]** key (talk/flash)
9. **[📖]** key (phonebook/left)
10. **[\*/tone]** key
11. **[hold]** key  
\*For multi-handset packs only: **[hold/int'com/xfer]** key
12. **[redial/pause]** key
13. **[select/✉]** key (select/messages)
14. **[ID]** key (caller ID/right)
15. **[.]** key (end call)
16. **[▼]** key (down)
17. **[#]** key
18. **[🔊]** key (speaker)
19. Handset Microphone
20. Handset Charging Contacts



## Base

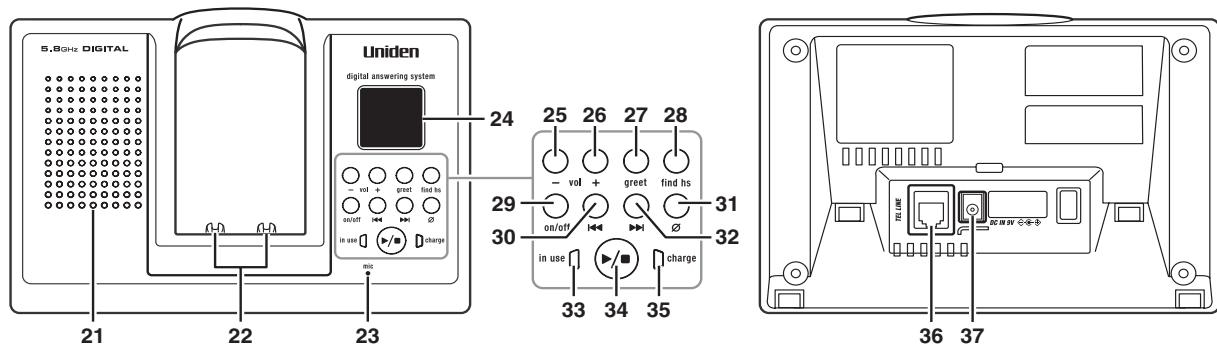

- 21. Base speaker
- 22. Base charging contacts
- 23. Base microphone
- 24. Message counter LED
- 25. [vol -] key
- 26. [vol +] key







- 27. [greet] key (record/greeting)
- 28. [find hs] key (find handset)
- 29. [on/off] key  
(answering system on/off)
- 30. [repeat] key (repeat)
- 31. [delete] key (delete)

- 32. [skip] key (skip)
- 33. in use LED
- 34. [play/stop] key (play/stop)
- 35. charge LED
- 36. TEL LINE Jack
- 37. DC IN 9V Jack

# Using the Interface

## Reading the Display

The handset display uses icons to tell you the status of your phone. The table below lists the icons and what they mean.

Icon	Status	Description
	Standby/Talk	The <b>battery</b> icon indicates the handset battery status: full, medium, low, and empty.
	Standby	The <b>ringer off</b> icon indicates that the ringer is turned off.
	Talk	The <b>mute</b> icon appears while the handset microphone is muted.
	Talk	The <b>boost</b> icon appears when the Clarity Boost feature is activated.
	Talk	The <b>speaker</b> icon appears when the handset speaker phone is in use.
	Talk	The <b>privacy</b> icon appears when the Privacy Mode is turned on.

## The Standby Screen

When the phone is in standby, the handset display shows the following items:

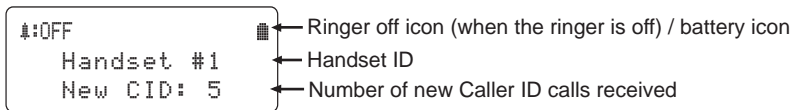

## Using the Four-way Function Key

Your handset has a four-way function key that allows you to move the cursor or pointer on the display and access the most commonly used features at the touch of a button. By moving this key to the left, you open the phonebook. Move the key to the right to access Caller ID information. To use this four-way key, place your thumb over the key on the handset and move to the four positions to get the feel of how it moves and operates.

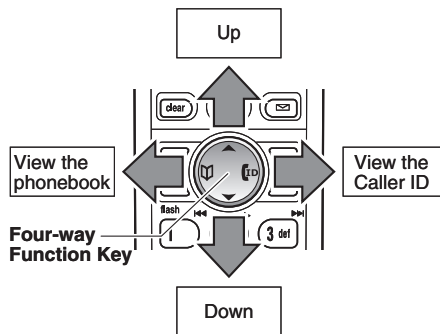

## Using the Handset Menus

To open the menu, press **[menu/clear]**. Select the option you want by pressing the four-way function key. This will move the cursor; the option currently selected has a triangle beside it. Activate the selected option by pressing **[select/☑]**. To exit the menu and return to standby, press **[\*]**.

If you do not press a key within 30 seconds, the phone will time out and exit the menu. When setting the day and time, the time-out period is extended to two minutes.

Note: For ANSW, SETUP and GLOBAL SETUP menu options, make sure the line is not in use and the handsets are within range of the base.

## Entering Text from Your Handset

You can use the number keypad on your handset to enter text by referring to the letters printed on each number key. When you press the number key in a text entry field, the phone displays the first letter printed on the number key. Press the number key twice to display the second letter and three times to display the third. Capital letters are displayed first, then lower case letters, then the number on the key.

If two letters in a row use the same number key, enter the first letter, then use **[right]** or **[left]** on the four-way function key to move the cursor to the next position to enter the second letter. For example, to enter the word "Movies":

- 1) Press **[6]** once to enter *M*.
- 2) Use **[right]** on the four-way function key to move the cursor to the right.
- 3) Press **[6]** six times to enter *o*.
- 4) Press **[8]** six times to enter *v*.
- 5) Press **[4]** six times to enter *i*.
- 6) Press **[3]** five times to enter *e*.
- 7) Press **[7]** eight times to enter *s*.
- 8) Press **[select/✉]** to end your text entry.

	Number of times key is pressed								
keys	1	2	3	4	5	6	7	8	9
<b>1</b>	1								
<b>2 abc</b>	A	B	C	a	b	c	2		
<b>3 def</b>	D	E	F	d	e	f	3		
<b>4 ghi</b>	G	H	I	g	h	i	4		
<b>5 jkl</b>	J	K	L	j	k	l	5		
<b>6 mno</b>	M	N	O	m	n	o	6		
<b>7 pqrs</b>	P	Q	R	S	P	q	r	s	7
<b>8 tuv</b>	T	U	U	t	u	v	8		
<b>9 wxyz</b>	W	X	Y	Z	w	x	y	z	9
<b>0 oper</b>	&	(	)	<	>	/	(blank)	--	--
	.	,	=	?	!	@	'	"	*
	#	0							

If you make a mistake while entering a name, use **[right]** or **[left]** on the four-way function key to move the cursor to the incorrect character. Press **[menu/clear]** to erase the wrong character, and then enter the correct character. To delete all characters, press and hold **[menu/clear]**.

# Installing the Phone

## Choosing the Best Location

When choosing a location for your new phone, here are some important guidelines you should consider:

- The location should be close to both a phone jack and a continuous power outlet (one which is not connected to a switch).
- The base and handset should be kept away from sources of electrical noise such as motors, microwave ovens, and fluorescent lighting.
- For better reception, place the base as high as possible.
- The base should be placed in an open area for optimum range and reception.
- If your home has wired alarm equipment connected to a phone line, be sure that installing the system does not disable your alarm equipment. If you have questions about what will disable alarm equipment, contact your telephone company or a qualified installer.

Note: For maximum range:

- Keep the antenna free of obstruction.
- When the handset is not in use, place the handset in an upright position.
- Do not hold the handset where you would block the signal.
- Metal and reinforced concrete may affect cordless telephone performance.

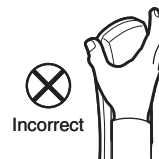
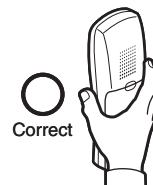

## Installing the Battery

Use only the Uniden BT-909 rechargeable battery pack supplied with your cordless telephone.

Follow the steps below to install the handset battery.

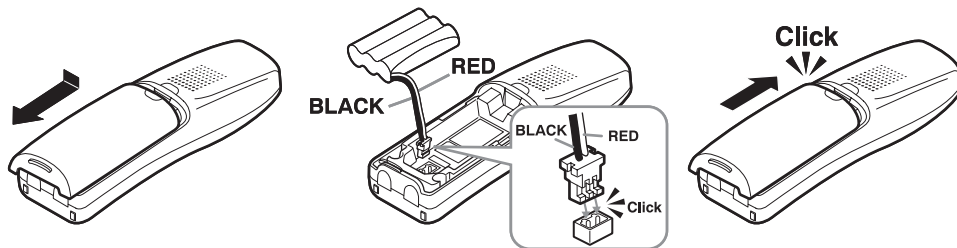

- 1) Press in on the handset battery case cover (use the finger indentation for a better grip) and slide the cover downward to remove.
- 2) Plug the battery cable into the battery jack. Be sure to match the red and black wires to the label near the jack. The cable should snap into place. Gently pull on the battery cable. If the battery connector comes loose, try connecting again until the battery snaps into place.
- 3) Place the battery case cover back on the handset and slide it upwards until it clicks into place.

## Connecting the Base and Charging the Handset

- 1) Connect the AC adapter to the DC IN 9V jack.

**CAUTION:** To avoid risk of fire and shock, only use the Uniden AD-800 AC adapter.

- 2) Connect the AC adapter to a standard 120V AC wall outlet.  
DO NOT use an AC outlet controlled by a wall switch.
- 3) Place the handset in the base with the LCD screen facing forward.
- 4) Make sure that the charge LED illuminates. If the LED does not illuminate, check to see that the AC adapter is plugged in and the handset makes good contact with the charging contacts.
- 5) Charge your handset at least 15 to 20 hours before plugging into the phone line.

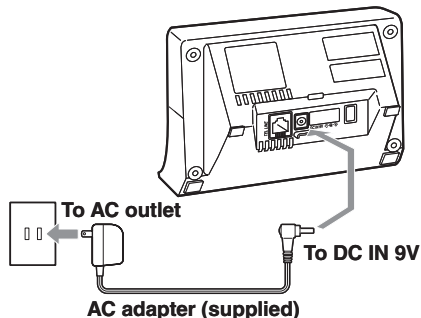

## Connecting the Charger and Charging the Handset (Multi-handset packs only)

- 1) Connect the AC adapter to the DC IN 9V jack and to a 120V AC outlet that is not controlled by a wall switch.

**Caution:** Use only the Uniden AD-0005 adapter.

- 2) Set the charger on a desk or tabletop, and place the handset in the charger with the keypad facing forward.
- 3) Make sure that the charge LED illuminates. If the LED does not illuminate, check to see that the AC adapter is plugged in and the handset makes good contact with the base charging contacts.
- 4) Charge the handset battery pack for at least 15-20 hours before using your new cordless telephone for the first time.

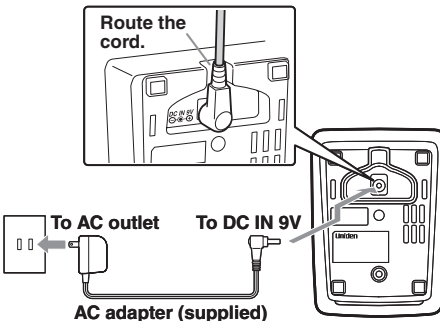

## Connecting to the Phone Line

Once the battery pack is fully charged, connect the telephone cord to the TEL LINE jack and to a telephone jack.

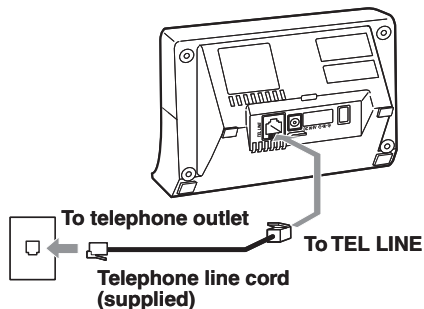

## Testing the Connection

Try making a call. If your call does not connect or you cannot get a dial tone, try the following steps:

- 1) Make sure the AC adapter cord is securely connected to the DC IN 9V jack and a standard power outlet.
- 2) Check to make sure the battery is fully charged. (If you don't see the "battery full" icon, check to make sure the battery is properly connected).
- 3) Change the dial mode (instructions on page 16).



## Changing the Dial Mode

Your phone can communicate with the telephone network in two different ways: tone dialing or pulse dialing. These days, most phone networks use a method called tone dialing, so your phone comes programmed for tone dialing. If your phone company uses pulse dialing, you will need to change your phone's dial mode. If you don't get a dial tone or can't connect to the telephone network, please follow the steps below to modify your phone's settings:

- 1) Press **[menu/clear]**. Select the GLOBAL SETUP menu, and then the DIAL MODE submenu.
- 2) Scroll **[▼]** to select PULSE.
- 3) Press **[select/✉]**. You will hear a confirmation tone.

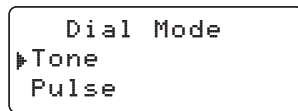

If you ever need to change the dial mode back to tone dialing, follow the same procedure, but select TONE in step 2.

# Basic Setup

## Selecting a Language

Your phone supports two languages: English and Spanish for USA models or English and French for Canadian models. Once you select a language, the menus on the phone will display in that language. The default language is English.

- 1) Press **[menu/clear]**. Select the HANDSET SETUP menu, and then the HANDSET LANGUAGE submenu.
- 2) Move the cursor to choose a language.  
for USA models: Choose ENGLISH or ESPAÑOL (Spanish).  
for Canadian models: Choose ENGLISH or FRANÇAIS (French).
- 3) Press **[select/☑]**. You will hear a confirmation tone.

```
Handset Language
▶English
Español
```

for USA models

```
Handset Language
▶English
Français
```

for Canadian models

## Activating Personal Ring

You can assign special ringer tones to anyone in your phonebook. When your phone gets a call, it looks up the Caller ID information in your phonebook. If you've assigned a personal ringer to that number, the phone uses it so you know who is calling. To turn on personal ringing, follow these steps:

- 1) Press **[menu/clear]**. Select the HANDSET SETUP menu, and then the PERSONAL RING submenu.
- 2) Move the cursor to select ON or OFF.
- 3) Press **[select/☑]**. You will hear a confirmation tone.

```
Personal Ring
▶On
Off
```

## Activating the Key Touch Tone

Key Touch Tone is the tone your keypad makes when keys are pressed. You can turn this tone on or off.

- 1) Press **[menu/clear]**. Select the HANDSET SETUP menu, and then the KEY TOUCH TONE submenu.
- 2) Move the cursor to select ON or OFF.
- 3) Press **[select/✉]**. You will hear a confirmation tone.

```
Key Touch Tone
▶On
Off
```

## Setting Up the Phonebook

Your handset can store up to 70 names and numbers in your phonebook. When all the phonebook entries are full, you will hear a beep and MEMORY FULL appears. You cannot store any additional names and numbers unless you delete some of the existing ones.

You can also use the phonebook entries to store a group of numbers (up to 20 digits) that you may need to enter once your call connects. This is referred to as chain dialing. See Chain Dialing from the Phonebook on page 26.

## Creating Phonebook Entries

To store names and numbers in your phonebook, please follow these steps:

- 1) When the phone is in standby mode, press [  ].
- 2) To create a new phonebook entry, move the cursor to select CREATE NEW, and press [select/✉]. EDIT NAME appears.

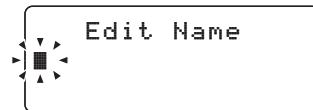

- 3) **Enter the name for this entry (EDIT NAME).**

Use the keypad to enter a name for this entry; the name can contain up to 16 characters. (See Entering Text from Your Handset on page 11 for instructions on entering text.) If you do not want to enter a name for this entry, your phone will store this entry as <NO NAME>. Press [select/✉] when you are finished.

- 4) **Enter the number for this entry (EDIT NUMBER).**

Once you have stored a name, EDIT NUMBER appears next. Use the number keypad to enter the phone number; the phone number can contain up to 20 digits. If you need the phone to pause between digits when it's dialing (for example, to enter an extension or an access code), press [redial/pause] to insert a two-second pause. You will see a P in the display. You can also use more than one pause together if two seconds is not long enough. Each pause counts as one digit.

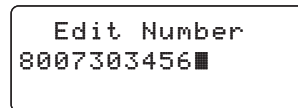

## 5) Assign a personal ring tone for this entry (PERSONAL RING).

You can attach a special ring tone to each phonebook entry; the phone will use this ring tone when this person calls. Use [▲] and [▼] to select one of the 7 different ring tone options (see Selecting a Ring Tone on page 23 for a complete list of ring tones). As you scroll through the tones, you will hear a sample of each tone. When you hear the ring tone you want to use, press [select/✉]. If you do not want to use a personal ring tone for this phonebook entry, choose NO SELECTION; the phone will use your standard ring tone setting.

```
Personal Ring
▶No Selection
Flicker
```

## Finding a Phonebook Entry

Press [⏏] to open the phonebook, and then select DIAL/EDIT or press [⏏] again. Phonebook entries are stored in alphabetical order. To scroll through the phonebook from A to Z, press [▼]. To scroll through the phonebook from Z to A press [▲].

You can also use the letters on the number keys to jump to a name that starts with that letter. Press a number key ([2] through [0]) once for the first letter, twice for the second letter, and so on. The phonebook jumps to the first entry that begins with the letter you entered; you can then use [▲] and [▼] to scroll to other entries. For example, to search for an entry beginning with the letter M, press 6 once.

To close the phonebook, press [⏏]. During a call, press [⏏] again instead of [⏏] to close the phonebook.

## Editing an Existing Phonebook Entry

- 1) With the phone in standby, press [⏏] to open the phonebook.
- 2) Select DIAL/EDIT or press [⏏] again.
- 3) Find the entry you want to edit and press [select/✉].
- 4) Follow the steps for Creating Phonebook Entries on page 19. If you do not wish to change the information at any step, simply press [select/✉] to go to the next step.

## Storing Caller ID or Redial Numbers in the Phonebook

You can store Caller ID records or redial numbers in the phonebook so you can use them later. Go to the Caller ID or redial list and select the number you want to store. (If the Caller ID information did not include the number, then you will not be able to store it.)

- 1) When the phone is in standby, press [**☰**] to open the Caller ID list or [**redial/pause**] to open the redial list.
- 2) Use [**▲**] and [**▼**] to scroll through the Caller ID records or redial numbers. When you come to the information you want to store, press [**select/✉**]. EDIT NAME appears.
- 3) If the phone number is already stored in memory, you will hear a beep, and THIS DATA IS ALREADY SAVED! appears in the display. The number will not be stored.

Continue by following the steps for Creating Phonebook Entries on page 19.

## Deleting Phonebook Entries

You can delete individual phonebook entries or delete all the phonebook entries at once.

- 1) When the phone is in standby, press [**☰**].
- 2) To delete a single phonebook entry, move the cursor to select DIAL/EDIT, and then press [**select/✉**] or press [**☰**] again.
- 3) Find the phonebook entry you want to delete and press [**menu/clear**].
- 4) DELETE ENTRY? appears in the display. Select YES, and then press [**select/✉**].
- 5) You will hear a confirmation tone, and DELETED! appears in the display.

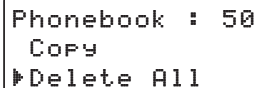

```
Phonebook : 50
Copy
Delete All
```

### Deleting all the phonebook entries at once

- 1) When the phone is in standby, press [**☰**].
- 2) Move the cursor to select DELETE ALL, and press [**select/✉**].
- 3) DELETE ALL? appears in the display. Select YES and then press [**select/✉**]. You will hear a confirmation tone, and DELETED! appears in the display.

## Copying Phonebook Entries to Another Handset (Multi-handset packs only)

If you have more than one handset, you can transfer phonebook entries from one handset to another without having to re-enter names and numbers. You can transfer one phonebook entry at a time or all phonebook entries at once.

- 1) When the phone is in standby, press [  ].
  - 2) Move the cursor to select COPY, and then press [select/✉].
  - 3) Move the cursor to select the handset which you want to transfer the entries to and then press [select/✉].
  - 4) Move the cursor to select ONE MEMORY or ALL MEMORY, and then press [select/✉].
  - 5) If you select ALL MEMORY, ARE YOU SURE? appears on the display screen. Move the cursor to select YES, and then press [select/✉].
  - 6) If you select ONE MEMORY, find the phonebook entry you want to transfer and then press [select/✉].
  - 7) The phonebook entries will be transferred to the designated handset. During the copy process, the receiving handset shows RECEIVING and the Handset ID of the sending handset.
  - 8) When the transfer is completed, DONE! appears on the handset.
- Note: If your phonebook contains 70 entries, you cannot store any new phonebook entries. You will hear a beep, and MEMORY FULL appears on the display. If the selected handset is out of range or data transfer is cancelled, UNAVAILABLE appears in the display. Phonebook listings will not be transferred.



```
Copy Phonebook
▶ One Memory
All Memory: 50
```

# Customizing Your Phone

## Selecting a Ring Tone (Handset only)

You may choose from 4 melodies or 3 tones for your phone's primary ring tone. If you have more than one handset, each handset can use a different ringer tone or melody. The available ring tones are listed below:

### Melodies

Fur Elise (ELISE)

We Wish You A Merry Christmas (MERRY-XMAS)

Aura Lee (AURA LEE)

Star Spangled Banner (STAR SPNGL)

### Ringers

Flicker

Clatter

Wake Up

- 1) Press **[menu/clear]**. Select the HANDSET SETUP menu, and then the RINGER TONES submenu.
- 2) Move the cursor to select a ring tone. As each ring tone is selected, you will hear a sample of the ring tone.
- 3) When you hear the tone you want to use, press **[select/☑]**. You will hear a confirmation tone.

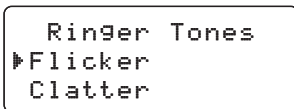



## Activating AutoTalk (Handset only)

AutoTalk allows you to answer the phone simply by removing the handset from the cradle. You do not have to press a button to answer the call.

- 1) Press **[menu/clear]**.
- 2) Select the HANDSET SETUP menu, and then the AUTOTALK submenu.
- 3) Select ON or OFF, and press **[select/✉]**. You will hear a confirmation tone.

```
AutoTalk
On
▶ Off
```

## Activating Any Key Answer (Handset only)

Any Key Answer allows you to answer the phone by pressing any key on the dial pad.



- 1) Press **[menu/clear]**.
- 2) Select the HANDSET SETUP menu, and then the ANY KEY ANSWER submenu.
- 3) Select ON or OFF, and then press **[select/✉]**. You will hear a confirmation tone.

```
Any Key Answer
On
▶ Off
```

## Using Your Phone

	From a cordless handset	From a handset speaker phone
<b>Making a call</b>	1) Remove the handset from the charging cradle. 2) Press <b>[*/flash]</b> . 3) Listen for the dial tone. 4) Dial the number. OR 1) Remove the handset from the charging cradle. 2) Dial the number. 3) Press <b>[*/flash]</b> .	1) Remove the handset from the charging cradle. 2) Press <b>[*☎]</b> . 3) Listen for the dial tone. 4) Dial the number. OR 1) Remove the handset from the charging cradle. 2) Dial the number. 3) Press <b>[*☎]</b> .
<b>Answering a call</b>	1) Pick up the handset. (If AutoTalk is on, the phone will answer when you remove the handset from the charging cradle.) 2) Press <b>[*/flash]</b> . (If Any Key Answer is on, you can also press any key on the twelve-number keypad.)	1) Pick up the handset. (If AutoTalk is on, the phone will answer when you remove the handset from the charging cradle.) 2) Press <b>[*☎]</b> .
<b>Hanging up</b>	Press <b>[*]</b> or return the handset to the cradle.	Press <b>[*]</b> or return the handset to the cradle.



## Making a Call from the Phonebook

- 1) When the phone is in standby, press [  ] to open the phonebook.
- 2) Move the cursor to select DIAL/EDIT, and then press [select/✉].
- 3) Find the phonebook entry you want to call (see Finding a Phonebook Entry on page 20).
- 4) Press [flash] or [  ] to dial the number.



Note: You can also press [flash] or [  ] before you open the phonebook. When you come to the phone number you want to dial, press [select/✉].

## Chain Dialing from the Phonebook

You can use the phonebook entries to store a group of numbers (up to 20 digits) that you may need to enter once your call connects. Once the call has connected you will then do the following:

- 1) Press [  ]
- 2) Use [  ] or [  ] to select the phonebook entry you want to call.
- 3) Press [select/✉]

## Switching to the Handset Speakerphone During a Call

To switch a normal call to the speakerphone, press [  ] on the handset. To switch from a speakerphone call to a normal call, press [  ].

## Using Caller ID, Call Waiting, and Redial Lists

If you subscribe to Caller ID from your phone company, your phone will show you the caller's phone number and name (if available) whenever a call comes in. If you subscribe to both Call Waiting and Caller ID, the phone also shows you the name and the number of any call that comes in while you're on the line.

**If your telephone provider supports seven-digit dialing, you can save your local area code so it does not display in the Caller ID list. See Seven-Digit Dialing on page 34 for more information.**

### Using the Caller ID List

You can store up to 30 Caller ID numbers in each handset. Caller ID records are stored from newest to oldest. Once your Caller ID list is full and you receive an incoming call, the oldest record will be automatically deleted to make room for the new record.

To open the Caller ID list, press **[\*#]** (on the right side of the four-way key). The phone will show the number of new Caller ID records and the total number of stored records. Use **[▲]** and **[▼]** to scroll through the list, or enter a letter on the keypad to jump to the first Caller ID name that starts with that letter.

### Making a Call from a Caller ID Record

- 1) When the phone is in standby, press **[\*#]** to open the Caller ID list.
- 2) Use **[▲]** and **[▼]** to find the Caller ID record you want to dial.
- 3) To add (or delete) a "1" to the beginning of the displayed phone number, press **[\*/tone]**.
- 4) Press **[#/flash]** or **[\*#>>]** to dial the number.

Note: You can also press **[#/flash]** or **[\*#>>]** before you open the caller ID list. When you come to the phone number you want to dial, press **[select/✉]**.

## Deleting Caller ID Numbers

To delete only one Caller ID number, go to the Caller ID list and select the number you want to delete. Press **[menu/clear]**. When the phone asks you to confirm, select YES.

To delete all the Caller ID numbers, go to the Caller ID list and press **[menu/clear]**. Select YES when asked if you want to DELETE ALL.

Note: When you delete a Caller ID number, you delete it permanently.

## Using Call Waiting

If you have Call Waiting service and a second call comes in when you are on the phone, a call waiting tone will sound. Press **[\*/flash]** to accept the waiting call. There is a short pause, and then you will hear the new caller. To return to the original caller, press **[\*/flash]**.

Note: You must subscribe through your telephone provider to receive Call Waiting services. Not all features are available in all areas.

## Redialing a Number

You can quickly redial the last 5 numbers dialed on each handset.

- 1) With the phone in standby, press the **[redial/pause]** to open the redial list.
- 2) Use **[▲]** and **[▼]** or **[redial/pause]** to scroll through the redial list.
- 3) When you find the number you want to dial, press **[/flash]** or **[▶▶]** on the handset to dial the number.

Note:

- If the number exceeds 32 digits, only the first 32 digits are retained in redial memory.
- If the redial memory is empty, EMPTY appears in the display and you will hear a beep.

## Deleting a Redial Record

If you want to delete a phone number from the handset's redial list, follow the steps below:

- 1) With the phone in standby, press **[redial/pause]**.
- 2) Use **[▲]** and **[▼]** to scroll through the redial list.
- 3) When you find the redial number you want to delete, press **[menu/clear]**.
- 4) Select YES, and press **[select/✉]**. The redial number is deleted.

# Adjusting the Ringer, Earpiece and Speaker Volume

## Adjusting the Ringer Volume

You can choose from four ringer volume settings on the handset (off, low, medium, and high) and four options (off, low, medium, and high) on the base. With the phone in standby, use [▲] or [▼] on the handset or [vol +] or [vol -] on the base to adjust the ringer volume.

## Adjusting the Earpiece Volume

You can choose from six volume levels for the earpiece. To adjust the earpiece volume while on a call, press [▲] (to make it louder) or [▼] (to make it softer).

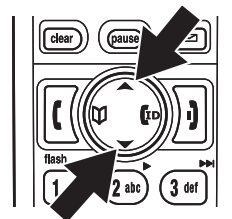

## Adjusting the Speaker Volume

**Handset Speakerphone:** You can choose from six volume levels for the handset speakerphone. To adjust the speaker volume while on a call, press [▲] (to make it louder) or [▼] (to make it softer).

**Base Speaker:** You can choose from ten volume levels for the base speaker. To adjust the speaker volume while call screening or playing messages, press [vol +] (to make it louder) or [vol -] (to make it softer).

## Adjusting the Audio Tone

If you aren't satisfied with the audio quality of your phone, you can adjust the Audio Tone of the earpiece while on a call. Your phone gives you three audio tone options: low, natural and high; the default setting, Natural Tone, is recommended for hearing aid users. Audio tone adjustments only apply to the earpiece, not the speakerphone.

To adjust the audio tone:

- 1) With the phone in talk mode, press **[select/✉]** to cycle through the three audio tone options.
- 2) When the desired option appears on the display, stop.
- 3) After two seconds, the displayed audio tone is set, and the display returns to normal.

## Using the Clarity Boost Feature

If you encounter interference while using your phone, you can manually improve the sound by setting the clarity booster to on. This works only when the phone is in use, so while you are on a call:

- 1) Press **[menu/clear]**.
  - 2) Move the cursor to CLARITY BOOST, and then press **[select/✉]**. BOOST ON and B appear in the display.
- Use the same procedure to turn off clarity booster. BOOST OFF appears.

## Finding a Lost Handset

To locate a misplaced handset, press **[find hs]** on the base when the phone is in standby. All registered handsets will beep for one minute, and PAGING appears on the handset display. To cancel paging, press **[find hs]** again or any key on the found handset.



# Using Conference and Transfer (Multi-handset packs only)

## Conferencing

If you have more than one handset, up to three people can participate in a conference call. A three-way conference call consists of an outside line and two handsets. You can easily join a call already in progress.

- 1) Press **[\*/flash]** or **[\*1)]** to join the call.
- 2) To hang up, return the handset to the cradle or press **[\*]**. The other party will still be connected to the call.

## Transferring a Call

You can transfer a call from one handset to another.

### From the handset:

- 1) During a call, press **[hold/int'com/xfer]**.
- 2) Use **[▲]** or **[▼]** to select the handset you want to transfer the call to, then press **[select/✉]**. The call will automatically be placed on hold, and a paging tone sounds. To cancel the transfer, press **[\*/flash]** or **[\*1)]**.
- 3) When another handset accepts the transferred call, you will be disconnected. If you want to rejoin the call, press **[\*/flash]** again or **[\*1)]**.

## Answering a Transferred Call

When a handset receives a call transfer, it sounds a paging tone; handsets also show the ID of the handset that is paging. To accept the call transfer:

- 1) To answer the page and speak to the transferring handset, press **[\*/flash]** or **[hold/int'com/xfer]** on the handset.
- 2) To accept the call and speak to the caller, press **[\*/flash]**.
- 3) When you accept the transferred call, the transferring handset will be disconnected.

Only the first handset to answer the transfer page will be connected to the call. If the transfer page is not picked up within one minute, the operation will be canceled.

# Using Special Features

## Muting the Ringer (One call only)

While the phone is ringing, press **[\*]** on the handset or **[▶/■]** on the base to mute the ringer for this call. The phone will ring again on the next call.

## Muting the Microphone

Mute turns off the microphone so the caller can't hear you. This only works while you are on a call.

### From the handset:

- 1) Press **[menu/clear]**.
- 2) Move the cursor to select MUTE and then press **[select/✉]**. MUTE ON and  appear in the display;  remains while muting is on.
- 3) To cancel muting, repeat the procedure, MUTE OFF appears.

## Privacy Mode

If you have more than one handset and don't want other handsets to interrupt you while on a call, turn on privacy mode. As long as your handset is in privacy mode, other handsets can't join your call or make any calls of their own: their displays will show UNAVAILABLE.

- 1) While on a call, press **[menu/clear]**.
- 2) Move the cursor to CALL PRIVACY, and then press **[select/✉]**. PRIVACY MODE ON appears in the display for 2 seconds;  appears and remains in the display until the feature is turned off.

To turn privacy mode off, repeat the procedure listed above.

## Seven-Digit Dialing

In some areas, the telephone company may allow you to place a local call by dialing only 7 digits (instead of 10). If this is the case in your area, you can program your local area code in your phone. Programming your area code will allow you to see the caller's 7-digit phone number which will allow you to easily return the local call without modifying the number before dialing. If you get a call from outside your area code, you will see all 10 digits.

To program your local area code:

- 1) Press **[menu/clear]**. Select the GLOBAL SETUP menu, and then the AREA CODE submenu.
- 2) Use the number keypad (**[0]** through **[9]**) to enter a 3-digit area code. If an area code has already been stored, it appears in the display. Press **[menu/clear]** to delete the stored code, and then enter a new one.
- 3) Press **[select/☑]**. You will hear a confirmation tone.

## Using the Intercom (Multi-handset packs only)

You can use the intercom to talk to another handset without using the phone line.

### Making an Intercom Page

**From the handset:**

- 1) With the phone in standby, press **[hold/int'com/xfer]**.
- 2) Use **[▲]** or **[▼]** to select the handset you want to talk with, then press **[select/☑]**. Select ALL to page all other handsets.
- 3) To cancel the intercom page, press **[i]**.

Note: Intercom paging will be cancelled if any of the following things occur:

- You receive an outside call or an intercom page while selecting the other handset.
- You do not select a handset within 30 seconds.
- The party does not answer the page within one minute.
- The party is busy.
- The party is out of range (UNAVAILABLE appears in the display).

## Answering an Intercom Page

When the intercom page tone sounds, the display will show the ID of the handset that is paging.

- 1) Press **[\*/flash]** or **[hold/int'com/xfer]**. If AutoTalk is on, the handset will automatically answer the page when you remove the handset from the cradle.
- 2) To hang up an intercom page from the handset, press **[\*]**.

## Tone Dialing Switch Over

If your phone is set to pulse dialing, you can temporarily switch to tone dialing after the call connects. This feature is useful when you need tone dialing to use automated menu systems, such as telephone bank tellers, telephone prescription refills, customer support menus, etc. Make your call normally. Once your call connects, press **[\*/tone]** on the handset. Any digits you enter from then on will be sent with tone dialing. When this particular call ends, the phone automatically returns to pulse dialing.

See Changing the Dial Mode on page 16 for instructions on setting your phone for pulse or tone dialing.

# Setting Up the Answering System

Your phone has a built-in answering system that answers and records incoming calls.

## Features

- Digital Tapeless Recording
- Up to 14 Minutes of Recording Time
- Call Screening
- Personal or Pre-recorded Outgoing Messages
- Bilingual Voice Prompts  
(for USA models: English and Spanish,  
for Canadian models: English and French)
- Day and Time Announcement
- Remote Message Retrieval
- Toll Saver
- Records Up to 59 messages.

Digital Tapeless Recording allows you to quickly review, save, or delete the messages you choose. You will never have to worry about a tape wearing out, jamming, or resetting improperly.

# Using the Answering System Interface

## Handset operation

You can use your handset to operate your answering system from anywhere in your home. When the phone is in standby, press **[select/☑]** on the handset to access the answering system. REMOTE ANSWERING MACHINE OPERATION appears on the handset display, and the system announces the number of new and old messages. Keep the following things in mind when you use your handset to access your answering system:

- You can enter a command at any time during announcements.
- After the first announcement, you have 30 seconds to enter your first command before the system returns to standby.
- If you receive a call, the remote operation is cancelled.
- If another handset makes a call, the remote operation is cancelled.
- During the remote operation “ - -” appears on the base.

## Selecting the Language

You can select the language (for USA models: English and Spanish, for Canadian models: English and French) of your answering system announcements. The default system language is English.

### From the handset:

- 1) Press **[menu/clear]**. Select ANSW. SETUP, and then the ANSW LANGUAGE submenu.
- 2) Move the cursor to choose a language.  
for USA models: Choose ENGLISH or ESPAÑOL (Spanish).  
for Canadian models: Choose ENGLISH or FRANÇAIS (French).
- 3) Press **[select/☑]**. You will hear a confirmation tone.

## Setting the Number of Rings

The ring time setting allows you to set the number of rings the caller hears before your answering system plays the outgoing message. You can set the ring time to answer after two, four, or six rings. If you enable the Toll Saver (TS) setting, the answering system picks up after two rings if you have new messages, and after four rings if there are none. This way, if you make a long distance call to check your messages, you can hang up after the second ring to avoid long distance billing charges.

### From the handset:

- 1) Press **[menu/clear]**. Select the ANSW. SETUP menu, and then the RING TIME submenu.
- 2) Move the cursor to select a ring time (TOLL SAVER, 2 TIMES, 4 TIMES, or 6 TIMES).
- 3) Press **[select/☑]**. You will hear a confirmation tone.

## Setting the Day & Time

If you do not set the clock on your answering system, your messages may not have the correct time and day stamp.

### From the handset:

- 1) Press **[menu/clear]**.
- 2) Move the cursor to ANSW. SETUP and press **[select/☑]**.
- 3) Move the cursor to DAY & TIME and press **[select/☑]**.
- 4) Use **[▲]** and **[▼]** to select the day of the week, and press **[select/☑]**.
- 5) Use the number keypad (**[0]** through **[9]**) to select the hour and minutes.
- 6) Use **[▲]** and **[▼]** to select AM or PM, and press **[select/☑]**. You hear a confirmation tone.

## Recording a Personal Greeting

Your answering system comes with a pre-recorded outgoing message or greeting that plays when you receive a call: "Hello, no one is available to take your call. Please leave a message after the tone." You can record your own personal outgoing greeting. Your recorded greeting must be between two seconds and thirty seconds long.

### From the base:

- 1) Press and hold **[greet]**.
- 2) The system announces, "Record greeting." Begin recording after the announcement. The message counter displays "- -", then begins to count down 30 seconds.
- 3) When you finish recording, press **[greet]** again or press **[▶/■]**. You will hear a confirmation tone, and your recorded greeting plays back for you.

## Selecting a Greeting

Once you have recorded a personal greeting, the phone automatically switches to your personal greeting. You can also switch back and forth between the pre-recorded greeting and your own greeting at any time.

### From the base:

- 1) With the phone in standby, press **[greet]**. The system plays the current greeting.
- 2) To keep this greeting, do nothing.
- 3) To switch to the other greeting, press **[greet]** while the system is playing the current greeting.
- 4) Each time you press **[greet]**, the system switches between the pre-recorded and the personal greeting. The last greeting you hear is used as the current greeting.



## Deleting Your Personal Greeting

You can delete your personal greeting from the base. You cannot delete the pre-recorded greeting.

### From the base:

- 1) With the phone in standby, press **[greet]**.
- 2) While the personal greeting is playing, press **[Ø]**.
- 3) The system announces "Greeting has been deleted," and switches back to the pre-recorded greeting.

## Setting the Record Time (or Announce only)

You can choose how long callers have to record a message. Set the record time to "1 minute" or "4 minutes" to limit the time for incoming messages. If you set the record time to "Announce only," the answering system answers the call but prevents callers from leaving a message.

### From the handset:

- 1) Press **[menu/clear]**. Select the ANSW. SETUP menu, and then the RECORD TIME submenu.
- 2) Move the cursor to select RECORD TIME (1 MINUTE, 4 MINUTES, or ANNOUNCE ONLY).
- 3) Press **[select/✉]**. You will hear a confirmation tone.

While your answering system is set to "Announce only," the message counter LED on the base displays "A." If you are using the prerecorded greeting, the system automatically switches to the following message: "Hello, no one is available to take your call. Please call again." If you are using a personal greeting, the system continues to use that greeting.

## Activating the Message Alert

The message alert feature sounds a short alert tone every 15 seconds whenever you have a new message. To turn on the message alert:

### From the handset:

- 1) Press **[menu/clear]**. Select the ANSW. SETUP menu, and then the MESSAGE ALERT submenu.
- 2) Move the cursor to select ON or OFF.
- 3) Press **[select/✉]**. You will hear a confirmation tone.

## Activating Call Screening

Your phone allows you to listen to callers leaving you a message. This call screen feature can be turned on or off.

### From the handset:

- 1) Press **[menu/clear]**. Select the ANSW. SETUP menu and then the CALL SCREEN submenu.
- 2) Move the cursor to select ON or OFF.
- 3) Press **[select/✉]**. You will hear a confirmation tone.

## Setting a Security Code or Personal Identification Number (PIN)

To play your messages from a remote location, you will need to enter a two-digit security code or Personal Identification Number (PIN). The default security code is 80.

### From the handset:

- 1) Press **[menu/clear]**. Select the ANSW. SETUP menu, and then the SECURITY CODE submenu.
- 2) Use the number keypad (**[0]** through **[9]**) to enter a two-digit security code (01-99).
- 3) Press **[select/✉]**. You will hear a confirmation tone.

# Using the Answering System

## Turning Your Answering System On and Off

	From the base	From the handset
Turning On	<ol style="list-style-type: none"><li>1) With the phone in standby, press <b>[on/off]</b>.</li><li>2) The system announces "Answering System is on" and plays the current greeting.</li><li>3) The message counter displays the number of messages stored in memory. If the counter flashes, then you have new messages waiting.</li></ol>	<ol style="list-style-type: none"><li>1) Press <b>[menu/clear]</b>. Select the ANSW. SETUP menu, and then the ANSWER SETUP submenu.</li><li>2) Move the cursor to select ON.</li><li>3) Press <b>[select/☑]</b>. You will hear a confirmation tone.</li></ol>
Turning Off	<ol style="list-style-type: none"><li>1) With the phone in standby, press <b>[on/off]</b>.</li><li>2) The phone announces "Answering System is off."</li><li>3) The message counter LED is no longer illuminated.</li></ol>	<ol style="list-style-type: none"><li>1) Press <b>[menu/clear]</b>. Select the ANSW. SETUP menu, and then the ANSWER SETUP submenu.</li><li>2) Move the cursor to select OFF.</li><li>3) Press <b>[select/☑]</b>. You will hear a confirmation tone.</li></ol>

## Reviewing Messages

The base message counter displays the number of messages stored in memory. When you have new messages, the message counter and the new message LED on the handset flash. The answering system plays your new messages first. After you listen to all of your new messages, you can then play your old messages. You can review your messages from the base or from the handset:

	From the base	From the handset
Playing messages	Press [▶/■]. The system announces the number of new and old messages. It announces the message number, plays the message, then announces the time and day it was received.	Press [select/✉]. The system announces the number of new and old messages and then play your messages. After playing the message, the system announces the time and day that message was received.
Repeating a message	Press [⏮] once to go to the beginning of the current message. Press [⏮] repeatedly to go back to a previous message.	Press [1] once to go to the beginning of the current message. Press [1] repeatedly to go back to a previous message.
Skipping a message	Press [▶▶] to go to the beginning of the next message.	Press [3] to go to the beginning of the next message.
Deleting a message	While a message is playing, press [∅]. The message is permanently deleted.	While a message is playing, press [4]. The message is permanently deleted.
Deleting all messages	While the phone is in standby, press [∅]. When the system asks you to confirm, press [∅] again. All messages are permanently deleted.	Not available.
Ending the message review	Press [▶/■] to stop the message playback and return to standby.	Press [5] to stop the message playback. Press [1] to exit the system and return to standby.

## Screening Calls

If you activate the call screening feature, you can listen to callers leaving a message without answering the phone (see Activating Call Screening on page 41). You can always hear callers from the base speaker. To screen an incoming call from the handset:

- Press **[select/✉]** when the system is answering. If another handset is screening a call, you will hear a beep and you will not be able to screen the call.
- To answer the call, press **[/flash]**.
- To stop screening the call, press **[\*]**.

## Turning Off the Message Alert Tone

When all new messages are played back, the message alert tone will automatically deactivate. The tone will not deactivate until all new messages are played back. To quickly turn off the tone, press any key on the base.

## Operating the Answering System While You Are Away from Home

You can access your answering system while you are away from home to check, play, and delete messages, or even record a new greeting message or turn your answering system on and off.

Note:

- The answering machine will only playback messages for four minutes and then it returns to the command waiting mode. To continue playing your messages, press **[0]** then **[2]** again within 15 seconds.
- If you enter an incorrect security code three times, you will hear a beep and the answering machine will return to standby.

To operate from a remote location, use any touch-tone telephone, and follow these steps:

- 1) Call your telephone number and wait for the system to answer. If the answering system is off, it will answer after about 10 rings and sounds a series of beeps.
- 2) During the greeting or the beeps (if answering system is off), press **[0]** and enter your security code/PIN within two seconds (see Setting a Security Code or Personal Identification Number (PIN) on page 41).
- 3) The answering system announces the current time and the number of messages stored in memory. You hear "To play incoming messages, press zero-two. For help, press one-zero" followed by a beep.
- 4) Enter a remote command from the chart below. You have 15 seconds to enter the first command; after the first command, you have two seconds to enter each command.

## Remote Commands

Command	Function	Command	Function
[0] then [1]	Repeat a message*	[0] then [5]	Stop operation
[0] then [2]	Play incoming messages	[0] then [6]	Answering system on
[0] then [3]	Skip a message	[0] then [9]	Answering system off
[0] then [4]	Delete a message	[1] then [0]	Help

\* If you press [0] then [1] in the first four seconds of a message, the system skips to the previous message.  
If you press [0] then [1] after the first four seconds of a message, the system repeats the current message.

- 5) When you finish, you will hear intermittent beeps indicating that the system is in the command waiting mode. Enter another command from the chart within 15 seconds.
- 6) Hang up to exit the system. The answering system automatically returns to its normal standby setting.

# Maintenance

## Specifications

Operating Temperature	32° F to 122° F (0° C to 50° C)
AC Adapter Part Number	Base: AD-800 Charging Cradle: AD-0005
Input Voltage	Base: 120V AC, 60 Hz Charging Cradle: 120V AC, 60 Hz
Output Voltage	Base: 9V DC @ 350mA Charging Cradle: 9V DC @ 210mA
Battery Part Number	BT-909
Capacity	3.6V DC @ 600mAh

### Notes:

- Use only the supplied AD-800 and AD-0005 AC adapters.
- Do not use any other AC adapter.
- Do not place the power cord where it creates a trip hazard or where it could become chafed and create a fire or electrical hazard.
- Do not place the base in direct sunlight or subject it to high temperatures.



## Battery Replacement and Handling

With average use, your phone's battery should last approximately one year. To order replacement batteries, please contact Uniden's Parts Department. The contact information is listed on the back cover page.

## Cleaning the Battery Contacts

To maintain a good charge, clean the charging contacts on the handset once a month. Dampen a cloth with plain water. Gently rub the damp cloth over the charging contacts until all visible dirt is removed. Dry the contacts thoroughly before returning the handset to the charging cradle.

**Caution:** Do not use paint thinner, alcohol, or other chemical products. Doing so may discolor the surface of the telephone and damage the finish.

## Warning

To avoid the risk of personal injury or property damage from fire or electrical shock, use only Uniden AD-800 (9V 350mA) and AD-0005 AC adapters and Uniden BT-909 battery pack with your phone.

## Caution:

- Use only the specified Uniden battery pack BT-909.
- Do not remove the batteries from the handset to charge them.
- Never throw the battery into a fire, disassemble, or heat them.
- Do not remove or damage the battery casing.
- A replacement Uniden adapter or battery may be purchased by calling Uniden's Parts department. See back cover page for contact information.

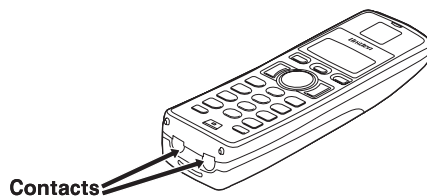

## Low Battery Alert

When the battery pack is very low, the phone is programmed to eliminate functions in order to save power. When LOW BATTERY appears in the display and the phone is in standby, none of the keys will operate. If you are on a call, complete your conversation as quickly as possible, and return the handset to the charging cradle.

The battery pack needs to be charged when the empty battery icon appears.

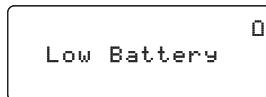

## Talk and Standby Times

With average use, your handset battery provides approximately 5 hours of talk time and approximately 7 days of standby time. When your handsets are not being used and are left off of their charging cradles, the battery will gradually discharge. You can achieve optimum battery life and performance by returning the handset to the charging cradle after each use. If the handset is left off of the charging cradle, the actual talk time duration will be reduced respective to the amount of time the handset is off of the charging cradle.

# Troubleshooting

## Changing the Digital Security Code

The digital security code is an identification code used to connect the handset and the base. Your unit ships from the manufacturer with a preset security code. Resetting this code is not normally necessary. In the rare situation that you suspect another cordless telephone is using the same security code or if you are instructed to change this code by a manufacturer's Call Center Representative, you can change the code. To change the digital security code:

- 1) Reset all of your handsets.
- 2) Register each handset.

To reset the handset:

- 1) Press and hold **[\*]** and **[#]** for more than 5 seconds.
- 2) Select DEREGISTER HS. Select the handset which you are operating, then press **[select/✉]**.
- 3) The phone will ask you to confirm the deregistration. Select YES. The handset will clear its registration information from the base, and then delete the link to the base from its own memory.
- 4) When the base information is deleted, the handset displays HANDSET NOT REGISTERED-PLACE HANDSET ON BASE TO REGISTER. SEE YOUR OWNER'S MANUAL FOR HELP.

If the handset cannot contact the base, it will display OUT OF RANGE. Make sure the handset is in range of the base and the base is connected to power.

To register the handset:

- 1) Place the handset in the telephone base charging cradle to begin registration.
- 2) During the registration process, HANDSET REGISTERING will appear in the LCD. When REGISTRATION COMPLETE is displayed, the handset has been registered to the base.

## Traveling Out of Range

During a call, if you move your handset too far from your base, noise may increase. If you pass the range limit of the base, the handset will beep, display OUT OF RANGE, and then go to standby. The base will maintain the connection for 30 seconds after the handset goes out of range. If you move the handset back within range of the base within 30 seconds, press **[\*/flash]** or **[\*]]]** to pick up the call again.

## Common Issues

If your phone is not performing to your expectations, please try these simple steps first. If these steps do not solve your problem, please call our Customer Hotline (see At Uniden, we'll take care of you! on page 66).

Symptom	Suggestion
The charge LED won't illuminate when the handset is placed in the cradle.	<ul style="list-style-type: none"><li>• Make sure the AC adapter is plugged into the base or the charger (if you have more than one handset) and wall outlet.</li><li>• Make sure the handset is properly seated in the cradle.</li><li>• Make sure the charging contacts on the handset are clean.</li></ul>
The audio sounds weak.	<ul style="list-style-type: none"><li>• Move the handset and/or base away from metal objects or appliances and try again.</li><li>• Make sure that you are not too far from the base.</li></ul>
Can't make or receive calls.	<ul style="list-style-type: none"><li>• Make sure that you are not too far from the base.</li><li>• Make sure the line is not in use. If an outside call is already using a line, you cannot use that line to make another outside call.</li><li>• Make sure your handset is registered to the main base unit.</li><li>• Check both ends of the base telephone line cord.</li><li>• Make sure the AC adapter is plugged into the base and wall outlet.</li><li>• Disconnect the AC adapter and reconnect.</li><li>• Change the Digital Security Code (see Changing the Digital Security Code on page 50).</li></ul>
Severe noise interference.	<ul style="list-style-type: none"><li>• Keep the handset away from microwave ovens, computers, remote control toys, wireless microphones, alarm systems, intercoms, room monitors, fluorescent lights, and electrical appliances.</li><li>• Move to another location or turn off the source of interference.</li></ul>
The Caller ID does not display.	<ul style="list-style-type: none"><li>• The call was placed through a switchboard.</li><li>• Call your telephone provider to verify your Caller ID service is current. There may be a problem with your Caller ID service.</li></ul>

<b>Symptom</b>	<b>Suggestion</b>
The handset doesn't ring or receive a page.	<ul style="list-style-type: none"> <li>• Make sure that you are not too far from the base.</li> <li>• Make sure that your handset is registered to the main base unit.</li> <li>• Charge the battery in the handset for 15 to 20 hours by placing the handset on the base or charging cradle.</li> <li>• Change the Digital Security Code (see Changing the Digital Security Code on page 50).</li> </ul>
The handset doesn't communicate with other handsets (Multi-handset packs only).	<ul style="list-style-type: none"> <li>• Change the Digital Security Code (see Changing the Digital Security Code on page 50).</li> </ul>
An extra handset can't join the conversation (Multi-handset packs only).	<ul style="list-style-type: none"> <li>• Make sure there are not two handsets already using the conference feature.</li> <li>• Make sure that another handset is not in privacy mode.</li> </ul>
The answering system does not work.	<ul style="list-style-type: none"> <li>• Make sure the base is plugged in.</li> <li>• Make sure that the answering system is turned on.</li> <li>• Make sure that the message record time is not set to announce only.</li> </ul>
Time stamp cannot be heard.	<ul style="list-style-type: none"> <li>• Make sure you have set the time (see Setting the Day and Time on page 38).</li> </ul>
Messages are incomplete.	<ul style="list-style-type: none"> <li>• Incoming messages may be too long. Ask callers to leave a brief message.</li> <li>• The memory may be full. Delete some or all of the saved messages.</li> </ul>
There is no sound on the base or handset speaker during call monitoring or message review.	<ul style="list-style-type: none"> <li>• Adjust the speaker volume on the base or handset.</li> <li>• Make sure the call screen feature is set to on.</li> </ul>
Cannot access answering system from a remote phone.	<ul style="list-style-type: none"> <li>• Make sure you are using the correct PIN number.</li> <li>• Make sure that the touch-tone phone you're using can transmit the tone for at least two seconds. If it cannot, try using a different touchtone phone.</li> </ul>

## Liquid Damage

Moisture and liquid can damage your cordless phone.

- If the handset or base is exposed to moisture or liquid, but only the exterior plastic housing is affected, wipe off the liquid, and use as normal.
- If moisture or liquid has entered the plastic housing (i.e. liquid can be heard in the phone or liquid has entered the handset battery compartment or vent openings on the base), follow the steps below:

Handset	Base
<ol style="list-style-type: none"><li>1) Remove the battery cover and leave it off for ventilation.</li><li>2) Disconnect the battery pack. Leave the battery cover off and the battery pack disconnected for at least 3 days.</li><li>3) Once the handset is completely dry, reconnect the battery pack and the battery cover.</li><li>4) Recharge the handset's battery pack for 15 to 20 hours before using.</li></ol>	<ol style="list-style-type: none"><li>1) Disconnect the AC adapter from the base, cutting off electrical power.</li><li>2) Disconnect the telephone cord from the base.</li><li>3) Let dry for at least 3 days.</li></ol>

**IMPORTANT:** You must unplug the telephone line while recharging the battery packs to avoid charge interruption.

**CAUTION:** **DO NOT use a microwave oven to speed up the drying process. This will cause permanent damage to the handset, base and the microwave oven. After following these steps, if your cordless telephone does not work, please call our Customer Service Hotline (see back cover page).**

## Precautions!

Before you read anything else, please observe the following:

### Warning!

Uniden America Corporation DOES NOT represent this unit to be waterproof. To reduce the risk of fire, electrical shock, or damage to the unit, DO NOT expose this unit to rain or moisture.

## Rechargeable Nickel-Metal-Hydride Battery Warning

- This equipment contains a rechargeable Nickel-Metal-Hydride battery.
- The rechargeable batteries contained in this equipment may explode if disposed of in a fire.
- Nickel is a chemical known to state of California to cause cancer.
- Do not short-circuit the battery.
- Do not charge the rechargeable battery used in this equipment in any charger other than the one designed to charge this battery as specified in the owner's manual. Using another charger may damage the battery or cause the battery to explode.

Rechargeable Batteries Must Be Recycled or Disposed of Properly.

Uniden works to reduce lead content in our PVC coated cords in our products and accessories.

## Warning!

The cords on this product and/or accessories contain lead, a chemical known to the State of California to cause birth defects or other reproductive harm. Wash hands after handling.

## Important Safety Instructions

When using your telephone equipment, basic safety precautions should always be followed to reduce the risk of fire, electric shock and injury to persons, including the following:

1. Do not use this product near water, for example, near a bath tub, wash bowl, kitchen sink or laundry tub, in a wet basement or near a swimming pool.
2. Avoid using a telephone (other than a cordless type) during an electrical storm. There may be a remote risk of electric shock from lightning.
3. Do not use the telephone to report a gas leak in the vicinity of the leak.
4. Use only the power cord and batteries indicated in this manual. Do not dispose of batteries in a fire. They may explode. Check with local authorities for possible battery disposal instructions.
5. Do not disassemble any component of this product.

## SAVE THESE INSTRUCTIONS

### CAUTION

Risk of explosion if battery is replaced by an incorrect type. Dispose of used batteries according to the instructions. Do not open or mutilate the battery, and disconnect the battery before shipping this product.



## The FCC Wants You To Know

This equipment complies with Part 68 of the FCC rules and the requirements adopted by the ACTA. On the bottom of this equipment is a label that contains, among other information, a product identifier in the format US: AAAEQ##TXXXX. If requested, this number must be provided to the telephone company.

An applicable Universal Service Order Codes (USOC) certification for the jacks used in this equipment is provided (i.e., RJ11C) in the packaging with each piece of approved terminal equipment. A plug and jack used to connect this equipment to the premises wiring and telephone network must comply with the applicable FCC Part 68 rules and requirements adopted by the ACTA. A compliant telephone cord and modular plug is provided with this product. It is designed to be connected to a compatible modular jack that is also compliant. See installation instructions for details.

The REN is used to determine the number of devices that may be connected to a telephone line. Excessive RENs on a telephone line may result in the devices not ringing in response to an incoming call. In most but not all areas, the sum of RENs should not exceed five (5.0). To be certain of the number of devices that may be connected to a line, as determined by the total RENs, contact the telephone provider. For products approved after July 23, 2001, the REN for this product is part of the product identifier that has the format US:AAAEQ##TXXXX. The digits represented by ## are the REN without a decimal point (e.g., 03 is a REN of 0.3). For earlier products, the REN is separately shown on the label.

If this equipment causes harm to the telephone network, the telephone company will notify you in advance that temporary discontinuance of service may be required. But if advance notice isn't practical, the telephone company will notify the customer as soon as possible. Also, you will be advised of your right to file a complaint with the FCC if you believe it is necessary. The telephone company may make changes in its facilities, equipment, operations or procedures that could affect the operation of the equipment. If this happens the telephone company will provide advance notice in order for you to make necessary modifications to maintain uninterrupted service.

Please follow instructions for repairing, if any (e.g. battery replacement section); otherwise do not substitute or repair any parts of the device except as specified in this manual. Connection to party line service is subject to state tariffs. Contact the state public utility commission, public service commission or corporation commission for information. This equipment is hearing aid compatible.

Should you experience trouble with this equipment, please contact Uniden customer service at 800-297-1023. If the equipment is causing harm to the telephone network, the telephone company may request that you disconnect the equipment until the problem is resolved.

**NOTICE:** According to telephone company reports, AC electrical surges, typically resulting from lightning strikes, are very destructive to telephone equipment connected to AC power sources. To minimize damage from these types of surges, a surge arrestor is recommended.

Changes or modifications to this product not expressly approved by Uniden, or operation of this product in any way other than as detailed by the owner's manual, could void your authority to operate this product.

This device complies with part 15 of the FCC rules. Operation is subject to the following two conditions: (1) This device may not cause harmful interference, and (2) This device must accept any interference received, including interference that may cause undesired operation. Privacy of communications may not be ensured when using this phone.

To insure the safety of users, the FCC has established criteria for the amount of radio frequency energy various products may produce depending on their intended usage. This product has been tested and found to comply with the FCC's exposure criteria. For body worn operation, the FCC RF exposure guidelines were also met when used with the Uniden accessories supplied or designed for this product. Use of other accessories may not ensure compliance with FCC RF exposure guidelines and should be avoided.

## Radio Interference

Radio interference may occasionally cause buzzing and humming in your cordless handset, or clicking noises in the base. This interference is caused by external sources such as TV, refrigerator, vacuum cleaner, fluorescent lighting, or electrical storm. Your unit is NOT DEFECTIVE. If these noises continue and are too distracting, please check around your home to see what appliances may be causing the problem. In addition, we recommend that the base not be plugged into a circuit that also powers a major appliance because of the potential for interference. Be certain that the antenna on the unit is fully extended when needed. In the unlikely event that you consistently hear other voices or distracting transmissions on your phone, you may be receiving radio signals from another cordless telephone or other source of interference. If you cannot eliminate this type of interference, you need to change to a different channel.

Finally, it should be noted that some cordless telephones operate at frequencies that may cause interference to nearby TVs and VCRs. To minimize or prevent such interference, the base of the cordless telephone should not be placed near or on top of a TV or VCR. If interference is experienced, moving the cordless telephone farther away from the TV or VCR will often reduce or eliminate the interference.

## Cordless Telephone Privacy

Cordless telephones are radio devices. Communications between the handset and base of your cordless telephone are accomplished by means of radio waves which are broadcast over the open airways. Because of the inherent physical properties of radio waves, your communications can be received by radio receiving devices other than your own cordless telephone unit. Consequently, any communications using your cordless telephone may not be private.

## I.C. Notice

### Terminal Equipment

**NOTICE:** This equipment meets the applicable Industry Canada Terminal Equipment Technical Specifications. This is confirmed by the registration number. The abbreviation, IC, before the registration number signifies that registration was performed based on a Declaration of Conformity indicating that Industry Canada technical specifications were met. It does not imply that Industry Canada approved the equipment.

**NOTICE:** The Ringer Equivalence Number (REN) for this terminal equipment is marked on the equipment itself. The REN assigned to each terminal equipment provides an indication of the maximum number of terminals allowed to be connected to a telephone interface. The termination on an interface may consist of any combination of devices subject only to the requirement that the sum of the Ringer Equivalence Numbers of all the devices does not exceed five.

### Radio Equipment

The term "IC:" before the radio certification number only signifies that Industry Canada technical specifications were met.

Operation is subject to the following two conditions: (1) this device may not cause interference, and (2) this device must accept any interference, including interference that may cause undesired operation of the device. "Privacy of communications may not be ensured when using this telephone."

# One Year Limited Warranty

Important: Evidence of original purchase is required for warranty service. **WARRANTOR:** UNIDEN AMERICA CORPORATION ("Uniden") **ELEMENTS OF WARRANTY:** Uniden warrants, for one year, to the original retail owner, this Uniden Product to be free from defects in materials and craftsmanship with only the limitations or exclusions set out below. **WARRANTY DURATION:** This warranty to the original user shall terminate and be of no further effect 12 months after the date of original retail sale. The warranty is invalid if the Product is (A) damaged or not maintained as reasonable or necessary, (B) modified, altered, or used as part of any conversion kits, subassemblies, or any configurations not sold by Uniden, (C) improperly installed, (D) serviced or repaired by someone other than an authorized Uniden service center for a defect or malfunction covered by this warranty, (E)

used in any conjunction with equipment or parts or as part of any system not manufactured by Uniden, or (F) installed or programmed by anyone other than as detailed by the owner's manual for this product. **STATEMENT OF REMEDY:** In the event that the product does not conform to this warranty at any time while this warranty is in effect, warrantor will either, at its option, repair or replace the defective unit and return it to you without charge for parts, service, or any other cost (except shipping and handling) incurred by warrantor or its representatives in connection with the performance of this warranty. Warrantor, at its option, may replace the unit with a new or refurbished unit. **THE LIMITED WARRANTY SET FORTH ABOVE IS THE SOLE AND ENTIRE WARRANTY PERTAINING TO THE PRODUCT AND IS IN LIEU OF AND EXCLUDES ALL OTHER WARRANTIES OF ANY NATURE WHATSOEVER, WHETHER EXPRESS, IMPLIED OR ARISING BY OPERATION OF LAW, INCLUDING, BUT NOT LIMITED TO ANY IMPLIED WARRANTIES OF MERCHANTABILITY OR FITNESS FOR**

**A PARTICULAR PURPOSE. THIS WARRANTY DOES NOT COVER OR PROVIDE FOR THE REIMBURSEMENT OR PAYMENT OF INCIDENTAL OR CONSEQUENTIAL DAMAGES.**

Some states do not allow this exclusion or limitation of incidental or consequential damages so the above limitation or exclusion may not apply to you.

**LEGAL REMEDIES:** This warranty gives you specific legal rights, and you may also have other rights which vary from state to state. This warranty is void outside the United States of America and Canada. **PROCEDURE FOR OBTAINING PERFORMANCE OF WARRANTY:** If, after following the instructions in the owner's manual you are certain that the Product is defective, pack the Product carefully (preferably in its original packaging). Disconnect the battery from the Product and separately secure the battery in its own separate packaging within the shipping carton. The Product should include all parts and accessories originally packaged with the Product. Include evidence of original purchase and a note describing the defect that has caused you to return it. The Product should be shipped freight prepaid, by traceable means, to warrantor at:

## **Uniden America Service**

4700 Amon Carter Blvd.

Fort Worth, TX 76155

# Index

## A

Accessibility .....	4
Answering calls.....	25
Answering system .....	36
Using the answering system interface .....	37
When away from home.....	45
Any key answer .....	24
Area code .....	34
AutoTalk.....	24

## B

Base	
Installing .....	14
Parts of the base .....	8
Battery	
Installing .....	13
Low battery alert.....	49
Replacement and handling.....	48
Talk and standby time.....	49

## C

Call screening.....	41, 44
Call waiting .....	28
Caller ID.....	27

Deleting Caller ID records .....	28
Making calls from.....	27
Chain dialing.....	26
Clarity boost.....	31
Conferencing .....	32

## D

Day and time .....	38
Dial mode .....	16, 35
Digital security code .....	50

## F

FCC statements.....	56
Finding a handset.....	31

## G

Greetings	
Deleting .....	40
Recording .....	39
Selecting.....	39

## H

Handset	
Accessing the answering system .....	42
Choosing a ringer .....	23
Copying phonebook entries.....	22
Displays and icons.....	9, 10

Entering text .....	11
Finding.....	31
Parts of the handset .....	7
Standby screen.....	10
Hanging up .....	25

## I

Installation .....	12
Intercom.....	34

## K

Key touch tone.....	18
---------------------	----

## M

Maintenance .....	47
Making calls.....	25
Using Caller ID .....	27
Using redial.....	29
Using the phonebook.....	26
Message alert .....	41, 44
Mute	
Microphone.....	33
Ringer .....	33

## O

Out of range.....	51
-------------------	----

## **P**

Personal identification number (PIN) .....	41
Personal ring .....	17
Phonebook .....	19
Copying entries.....	22
Creating new entries.....	19
Deleting entries.....	21
Editing entries.....	20
Finding entries .....	20
Making calls from.....	26
Storing Caller ID or redial numbers.....	21
Privacy mode.....	33
Pulse dialing .....	16, 35

## **R**

Redial	
Deleting a record .....	29
Making calls with .....	29
Ringer	
Choosing a handset ringer .....	23
Muting.....	33
Personal ring .....	17

## **S**

Safety notices .....	55
Screening calls .....	41, 44
Security code	
Answering system.....	41
Seven-digit dialing .....	34

## **T**

Text, entering .....	11
Tone dialing .....	16, 35
Transferring a call .....	32

## **V**

Volume, adjusting .....	30
-------------------------	----

## **W**

Warranty .....	58
----------------	----

# Memo

# Memo

# Memo



# Remote Operation Card

CUT

## REMOTE OPERATION CARD

### Uniden®

#### Remote access away from home

1. Call your phone number from a touch-tone phone.
2. During the outgoing message, press 0 and enter your PIN code. The answering system announces the number of messages stored in memory and the voice prompts.
3. To quit, hang up the phone.

#### Turn on the answering machine remotely

1. Call your phone and let it ring 10 times until you hear a beep.
2. Press 0 and then enter your PIN code.
3. Press 0 then 5 to stop the announcement.
4. Press 0 then 6 to turn the answering system on.

CUT

## REMOTE OPERATION CARD

### Uniden®

#### Remote access away from home

1. Call your phone number from a touch-tone phone.
2. During the outgoing message, press 0 and enter your PIN code. The answering system announces the number of messages stored in memory and the voice prompts.
3. To quit, hang up the phone.

#### Turn on the answering machine remotely

1. Call your phone and let it ring 10 times until you hear a beep.
2. Press 0 and then enter your PIN code.
3. Press 0 then 5 to stop the announcement.
4. Press 0 then 6 to turn the answering system on.

CUT

## REMOTE OPERATION CARD

### Uniden®

#### Remote access away from home

1. Call your phone number from a touch-tone phone.
2. During the outgoing message, press 0 and enter your PIN code. The answering system announces the number of messages stored in memory and the voice prompts.
3. To quit, hang up the phone.

#### Turn on the answering machine remotely

1. Call your phone and let it ring 10 times until you hear a beep.
2. Press 0 and then enter your PIN code.
3. Press 0 then 5 to stop the announcement.
4. Press 0 then 6 to turn the answering system on.

CUT

## REMOTE OPERATION CARD

### Uniden®

#### Remote access away from home

1. Call your phone number from a touch-tone phone.
2. During the outgoing message, press 0 and enter your PIN code. The answering system announces the number of messages stored in memory and the voice prompts.
3. To quit, hang up the phone.

#### Turn on the answering machine remotely

1. Call your phone and let it ring 10 times until you hear a beep.
2. Press 0 and then enter your PIN code.
3. Press 0 then 5 to stop the announcement.
4. Press 0 then 6 to turn the answering system on.

CUT

Task	Key
Repeat a Message	<input type="radio"/> 0 <input type="radio"/> 1
Play Incoming Messages	<input type="radio"/> 0 <input type="radio"/> 2 abc
Skip a Message	<input type="radio"/> 0 <input type="radio"/> 3 def
Delete a Message	<input type="radio"/> 0 <input type="radio"/> 4 ghi
Stop Operation	<input type="radio"/> 0 <input type="radio"/> 5 jkl
Answering System On	<input type="radio"/> 0 <input type="radio"/> 6 mno
Answering System Off	<input type="radio"/> 0 <input type="radio"/> 9 wxyz
Help	<input type="radio"/> 1 <input type="radio"/> 0 oper

CUT

Task	Key
Repeat a Message	<input type="radio"/> 0 <input type="radio"/> 1
Play Incoming Messages	<input type="radio"/> 0 <input type="radio"/> 2 abc
Skip a Message	<input type="radio"/> 0 <input type="radio"/> 3 def
Delete a Message	<input type="radio"/> 0 <input type="radio"/> 4 ghi
Stop Operation	<input type="radio"/> 0 <input type="radio"/> 5 jkl
Answering System On	<input type="radio"/> 0 <input type="radio"/> 6 mno
Answering System Off	<input type="radio"/> 0 <input type="radio"/> 9 wxyz
Help	<input type="radio"/> 1 <input type="radio"/> 0 oper

CUT

Task	Key
Repeat a Message	<input type="radio"/> 0 <input type="radio"/> 1
Play Incoming Messages	<input type="radio"/> 0 <input type="radio"/> 2 abc
Skip a Message	<input type="radio"/> 0 <input type="radio"/> 3 def
Delete a Message	<input type="radio"/> 0 <input type="radio"/> 4 ghi
Stop Operation	<input type="radio"/> 0 <input type="radio"/> 5 jkl
Answering System On	<input type="radio"/> 0 <input type="radio"/> 6 mno
Answering System Off	<input type="radio"/> 0 <input type="radio"/> 9 wxyz
Help	<input type="radio"/> 1 <input type="radio"/> 0 oper

CUT

Task	Key
Repeat a Message	<input type="radio"/> 0 <input type="radio"/> 1
Play Incoming Messages	<input type="radio"/> 0 <input type="radio"/> 2 abc
Skip a Message	<input type="radio"/> 0 <input type="radio"/> 3 def
Delete a Message	<input type="radio"/> 0 <input type="radio"/> 4 ghi
Stop Operation	<input type="radio"/> 0 <input type="radio"/> 5 jkl
Answering System On	<input type="radio"/> 0 <input type="radio"/> 6 mno
Answering System Off	<input type="radio"/> 0 <input type="radio"/> 9 wxyz
Help	<input type="radio"/> 1 <input type="radio"/> 0 oper

## At Uniden, we'll take care of you!

Thank you for purchasing a Uniden product. If you have any questions or problems, please do not return this product to the place of purchase.

<b>Having trouble?</b>	Our customer care specialists are here to help you! Visit our web-site at <b>www.uniden.com</b> or call our Customer Service Hotline at <b>1-800-297-1023</b> during regular business hours.*
<b>Need a part?</b>	To order replacement batteries or other accessories, visit our website at <b>www.uniden.com</b> or call <b>1-800-554-3988</b> during regular business hours.*
<b>Help for our customers with special needs</b>	If you need special assistance due to a disability or have questions on the accessibility features of this product, please call <b>1-800-874-9314 (voice or TTY)</b> .

\* Central Standard Time. Detailed customer service hours are available at [www.uniden.com](http://www.uniden.com).

May be covered under one or more of the following U.S. patents:

4,797,916	5,426,690	5,434,905	5,491,745	5,493,605	5,533,010	5,574,727	5,581,598
5,650,790	5,660,269	5,661,780	5,663,981	5,671,248	5,696,471	5,717,312	5,732,355
5,754,407	5,758,289	5,768,345	5,787,356	5,794,152	5,801,466	5,825,161	5,864,619
5,893,034	5,912,968	5,915,227	5,929,598	5,930,720	5,960,358	5,987,330	6,044,281
6,070,082	6,125,277	6,253,088	6,314,278	6,418,209	6,618,015	6,671,315	6,714,630
6,782,098	6,788,920	6,788,953	6,839,550	6,889,184	6,901,271	6,907,094	6,914,940
6,953,118	7,023,176						

Other patents pending.

**Uniden** | A World Without Wires\*

VISIT  
**WWW.UNIDEN.COM**  
TO REGISTER YOUR  
PRODUCT

© 2007 Uniden America Corporation, Fort Worth, Texas. Contains additional foreign articles. Printed in China.