

tru24
24.GHZ
DIGITAL SPREAD SPECTRUM

OWNER'S MANUAL

Uniden®

TRU241



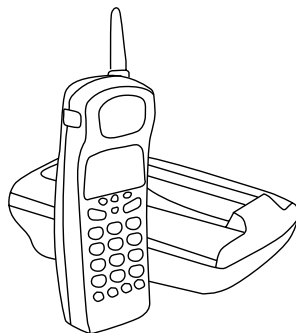

CONTENTS

Introduction	1
Features	1
Included with Your TRU 241 Phone	3
Controls and Functions	4
Installation	5
• Charging the Battery Pack	5
• Charging the Handset	5
• Low Battery Indicator	5
• Cleaning the Battery Contacts	6
• Selecting a Location	6
• Setting the Dial Mode Switch	6
• Mounting the Base Unit on the Wall	7
• Direct Wall Plate Mounting	8
Setting Up Your Phone	9
• Raising the Antenna	9
• Connect the Base Unit	9
• Adjusting Ringer/Volume Controls	9
Ringer Tone and Volume	9
Setting the Handset Earpiece Volume	9
Using Your Phone	10
• Making and Receiving Calls	10
• Storing a Number in Memory	10
• Entering a Pause in Memory Dialing	11
• Storing Mixed Tone/Pulse Numbers	11
• Dialing a Stored Number	11
• Chain Dialing	12
• Erasing a Stored Number	12
• Mute	12
• Replacing a Stored Number	12
• Selecting a Different Channel	13
• Using the Flash Button	13
• Using the Page/Find Feature	13
• Traveling Out of Range	13
Troubleshooting	14
Installing the Beltclip	15
• To Attach the Beltclip	15
• To Remove the Beltclip	15
Headset Installation	15

INTRODUCTION

The Uniden® 2.4 GHz cordless phones are designed and engineered to exacting standards for reliability, long life, and outstanding performance.

Digital Spread Spectrum Technology utilizes a “wider frequency band” vs. a “single narrow band” used in standard digital transmissions. The 2.4 GHz frequency range was recently released to commercial communications. It provides secure conversation with the clarity of digital sound, extended range, and reduced interference.

FEATURES

- 2.4 GHz Digital Spread Spectrum
- 30 Channel Autoscan
- 10-Number Memory Dialing
- Desk or Wall Mountable
- Tone/Pulse Dialing
- Handset Volume Control
- 32 Digit Redial
- Page/Find
- AutoTalk™
- AutoStandby™
- 6 Hour Talk Time
- 7 Day Standby Time
- Hearing Aid Compatible

The TRU 241 features include *AutoTalk* and *AutoStandby*.

AutoTalk allows you to answer a call by just removing the handset from the base so you don't have to waste time pushing buttons or flipping switches. *AutoStandby* allows you to hang up by simply returning the handset to the base.

The *UltraClear Plus™* true compander circuitry virtually eliminates background noise. This innovative technology, together with 30 different channels, provides you with the best possible reception during all your conversations.

To protect you against misbilled calls which might result from your phone being activated by other equipment, the TRU 241 has *Random Code™* digital security which automatically selects one of over 65,000 digital security codes for the handset and base.

Also, the *AutoSecure™* feature electronically locks your phone when the handset is in the base.

To get the most from your phone, please read this owner's manual thoroughly. Also, be sure to complete the product registration form and mail it in.

Be sure to visit our web site at: www.uniden.com.

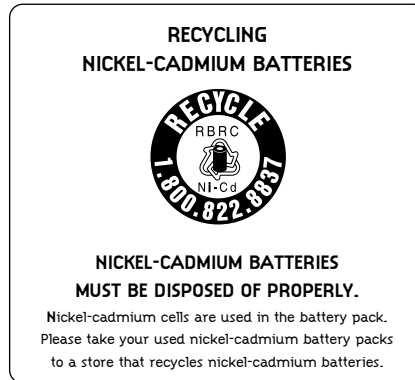

Uniden® is a registered trademark of Uniden America Corporation.
AutoTalk, AutoStandby, Random Code, UltraClear Plus, and AutoSecure are trademarks of Uniden America Corporation.

INCLUDED WITH YOUR TRU 241 PHONE

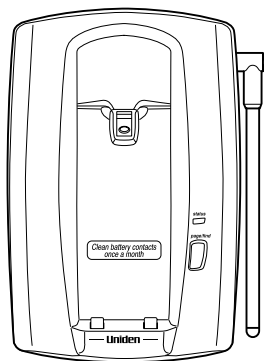

Base



Handset

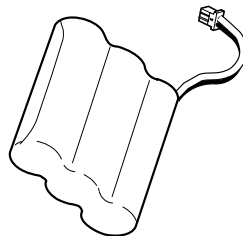

Rechargeable Battery

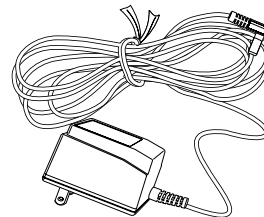

AC Adapter

Also included:

- This Owner's Manual
- Other Printed Material
- Precautions and Important Safety Instructions
- Memo Sticker

If any of these items are missing or damaged, contact the Uniden Parts Department at (800) 554-3988, 7:00 a.m. to 5:00 p.m. Central, Monday through Friday, or contact us on the web at www.uniden.com.



Beltclip

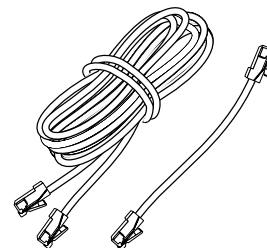

Telephone Cords

CONTROLS AND FUNCTIONS

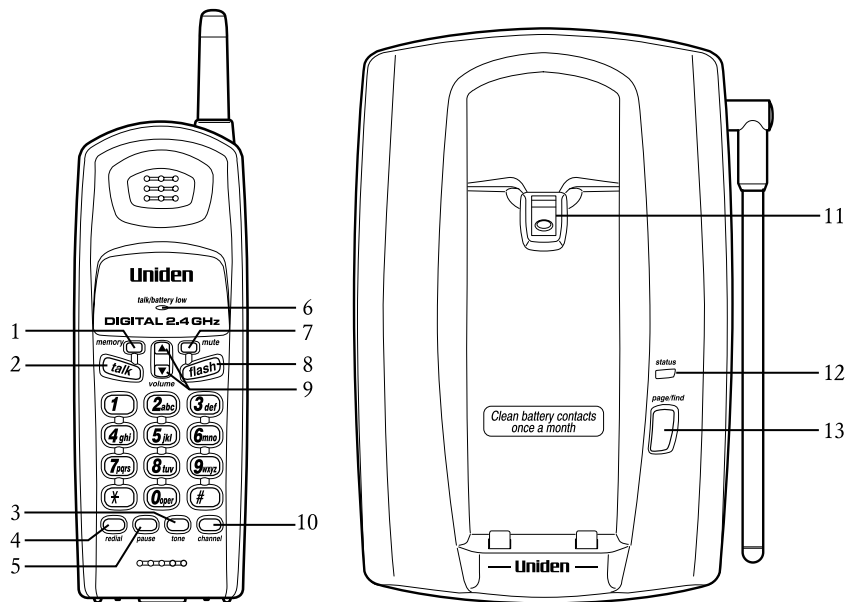

1. **memory** – Enters or recalls numbers in memory
2. **talk** – Answers or places calls
3. **tone** – Switches to tone dialing in pulse dial mode
4. **redial** – Redials the last number
5. **pause** – Adds a timed pause in a memory dialing sequence
6. **talk/battery low** LED – indicates when phone is in use or the battery is low
7. **mute** – Turns off the handset microphone while you are using the phone
8. **flash** – Accesses call waiting (if available)
9. **volume** – Sets both the ringer and earpiece volumes
10. **channel** – Selects another channel for clearer reception
11. **handset retainer** – Holds handset in base for wall mounting.
12. **status** LED – Indicates the phone is in use or the handset is charging
13. **page/find** – Locates the handset

INSTALLATION

Charging the Battery Pack

The rechargeable nickel-cadmium battery pack must be fully charged before using your phone for the first time. **Before plugging the phone line into your new phone, you must charge the battery for approximately 15 hours without interruption.**

1. Remove the handset battery cover.
2. Plug the battery cable into the handset and place the battery pack inside the battery compartment.
3. Replace the battery cover.

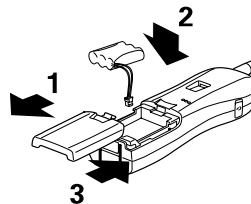

▼ Charging the Handset

Place the handset on the base to charge. *(The handset can charge in either the face-up or face-down position.)*

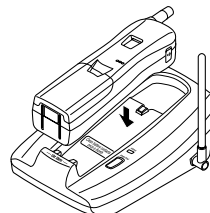

▼ Low Battery Indicator

When the battery pack in the handset is low and needs to be charged, the **talk/battery low** indicator flashes. If this occurs while you are on the phone, you will hear an alert tone. Complete your call as quickly as possible and return the handset to the base for charging.

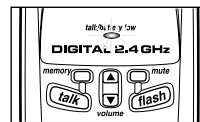

The plastic connectors will fit together only one way. Make sure the battery's connector is properly aligned. Use only the Uniden battery pack (model BT-905).



A continuous power outlet is an AC outlet which does not have a switch to interrupt its power.



Do not place the power cord in an area where it may create a trip hazard or become chafed and create a fire or electrical hazard.

▼ *Cleaning the Battery Contacts*

To maintain a good charge, it is important to clean all battery contacts on the handset and base about once a month.

Use a dry cloth or pencil eraser, if necessary.

Do not use any liquids or solvents.

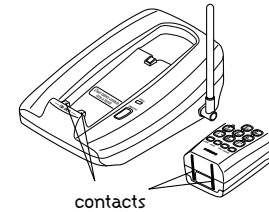

Selecting a Location

Before choosing a location for your new phone, there are some important guidelines you should consider:

- The location should be close to both a phone jack and continuous power outlet.
- Keep the base unit and handset away from sources of electrical noise such as motors or fluorescent lighting.
- Be sure there is sufficient space to rotate the base unit antenna to a vertical position.



Setting the Dial Mode Switch

Place the switch in the *T* position for tone dialing, or the *P* position for pulse dialing.

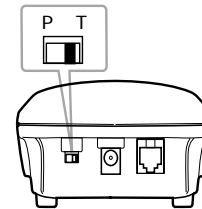

Mounting the Base Unit on a Wall

▼ Standard Wall Plate Mounting

This phone can be mounted on any standard telephone wall plate.

1. Snap the wall mount adapter into the notches on the base.
2. Plug the telephone line cord to the **TEL LINE** jack and the AC adapter to the **DC IN 9V** jack.
3. Plug the telephone line cord into the telephone outlet.
4. Wrap the AC adapter cord inside the molded wiring channel. Then wrap the cord around the strain relief notch.
5. Plug the AC adapter into a standard 120V AC wall outlet.
6. Raise the antenna to a vertical position.
7. Align the mounting slots on the base with the mounting posts on the wall. Push in and down until the phone is firmly seated.
8. On the base unit, pull the handset retainer out of the slot. Rotate it clockwise 180 degrees.
9. Flip the retainer from front to back. Slide it back into the slot so that the lip of the retainer is up and the oval is down. The retainer holds the handset in place.

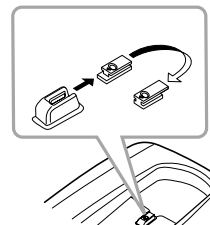
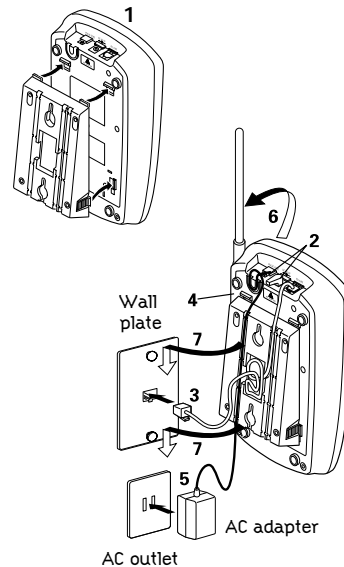

Direct Wall Plate Mounting

If you don't have a standard wall plate, you can mount your phone directly to the wall. Before doing this, consider the following:

- Avoid electrical cables, pipes, or other items behind the mounting location that could cause a hazard when inserting screws into the wall.
 - Try to mount your phone within 10-15 feet of a working phone jack to avoid excessive cord lengths.
 - Make sure the wall material is capable of supporting the weight of the base and handset.
 - Use #10 screws (minimum length of 1-3/8 inches) with anchoring devices suitable for the wall material where the base unit will be placed.
1. Insert two mounting screws into the wall, (with their appropriate anchoring device), 3-15/16 inches apart. Allow about 3/16 of an inch between the wall and screwheads for mounting the phone.
 2. Refer to steps 1 through 9 as in the "Mounting the Base Unit on a Wall" section. (See page 7.)

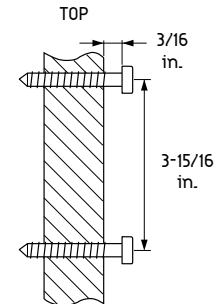

SETTING UP YOUR PHONE

Raising the Antenna

Before using your phone, be sure to raise its antenna to the vertical position.



Connect the base unit

If you want to install the base unit on the wall, see page 7.

1. Connect the telephone line cord to the **TEL LINE** jack and to a telephone outlet.
2. Connect the AC adapter to the **DC IN 9V** jack and to a standard 120 V AC wall outlet.
3. Set the base unit on a desk or tabletop and place the handset on the base unit. Then raise the antenna to a vertical position.

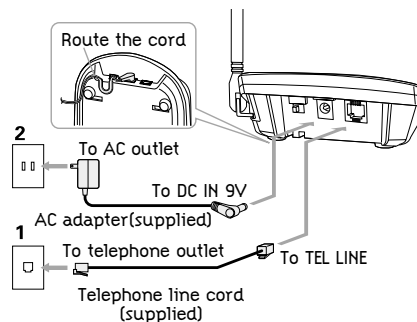

Place the power cord so it does not create a trip hazard or where it could become chafed and create a fire or electrical hazard.

Adjusting Ringer/Volume Controls

▼ Ringer Tone and Volume

1. While the phone is not in use, press **volume** .
2. The phone has two ringer tones, each with two volume levels. Press **volume** again until you hear the ringer tone and volume level you want.

▼ Setting the Handset Earpiece Volume

1. While you are on a call, press **volume** .
2. The phone has four receiver volume levels, Low, Medium, High, and Maximum. Press **volume** again until you hear the volume level you want. When you hang up, the phone keeps the last volume setting selected.

USING YOUR PHONE

Making and Receiving Calls

	Handset on Base	Handset off Base
Answer call	When the phone rings, remove the handset from the base. (<i>AutoTalk</i>)	Press any key.
Make call	<ol style="list-style-type: none">1. Remove the handset from the base and press talk.2. The talk/battery low LED lights.3. Listen for the dial tone.4. Dial the number.	<ol style="list-style-type: none">1. Pick up the handset and press talk.2. The talk/battery low LED lights.3. Listen for the dial tone.4. Dial the number.
Hang up	Return handset to the base, (<i>AutoStandby</i>) or press talk .	Press talk .
Redial	<ol style="list-style-type: none">1. Remove the handset from the base and press talk.2. Listen for the dial tone.3. Press redial to dial the last number dialed.	<ol style="list-style-type: none">1. Pick up the handset and press talk.2. Listen for the dial tone.3. Press redial to dial the last number dialed.



- You have 20 seconds after pressing **memory** to enter the number you wish to store. Otherwise, an error tone will sound.
- Write down stored numbers on the supplied memo sticker.

Storing a Number in Memory

Your TRU 241 phone has 10 memory locations for storing important telephone numbers.

1. Remove the handset from the base and press **memory**. The **talk/battery low** LED flashes.
2. Enter the phone number you want to store (up to 20 digits).
3. Press **memory** and enter a number (0-9) on the keypad for the memory location you want to use. You hear a long beep and the **talk/battery low** LED goes out indicating the number has been stored successfully.

If you select any keys other than 0-9, the handset will beep rapidly and no number will be stored.

Entering a Pause in Memory Dialing

If you would like to use a phone number stored in memory to access voice mail, for example, you can store a pause in the phone number sequence.

To use this function, follow steps 1 and 2 in “*Storing a Number in Memory*”, then press the **pause** button on the handset to place a pause in the phone number sequence.

Follow the remaining steps in the “*Storing a Number in Memory*” section to complete the operation.

Storing Mixed Tone/Pulse Numbers

If your phone is set up for pulse dialing, you can store a mixed mode number (up to 20 digits) to easily access long distance services.

1. Remove the handset from the base and press **memory**. The **talk/battery low** LED flashes.
2. Enter the number to be dialed in pulse mode.
3. Press the **tone** button on the handset. The **tone** button counts as one digit and enters a pause.
4. Enter the number(s) to be dialed in tone mode.
5. Press **memory** and a number (0-9) on the keypad for the memory location you wish to use. You hear a long beep and the **talk/battery low** LED goes out.

Dialing a Stored Number

To dial a phone number stored in memory, press **talk**, then press **memory** and the memory location (0-9). Your phone will dial the stored number.



- Remember, the phone number you wish to store cannot have more than 20 digits, including the pause. (The **pause** button counts as one digit.)

- If you select a memory location that does not have a stored number, the handset will beep rapidly and the phone will not dial.

Chain Dialing

After dialing a number you may be requested to enter a special access code, for example, when performing a banking transaction.

1. Store the access code into one of the memory locations (0-9).
2. Dial the main number.
3. Press **memory** and the memory location of the access code at the appropriate time.

Erasing a Stored Number

1. Remove the handset from the base.
2. Press **memory** twice.
3. Press the memory location number (0-9) you want to erase. You hear a long beep confirming that you have erased the number.

Mute

You can temporarily turn off the handset microphone so that the person you are talking with cannot hear you. During a telephone call, press **mute** to turn off the microphone. To cancel mute, press **mute** or **talk**.

Replacing a Stored Number

Remember, your TRU 241 phone has 10 memory locations represented by the numbers 0-9 on the keypad. If you store a phone number in one of these locations, then attempt to store a different number in the same location later, the new number will **replace** the previous one.

Selecting a Different Channel

If you encounter interference while using your phone, you can manually change the phone's channel for clear operation. Interference can come from appliances or other phones in your home. This function works only when the phone is in use.

The **channel** button on the handset allows you to choose between 30 factory set channels. During the course of a conversation, if you hear static or noise which makes it difficult to hear, press **channel**. The **talk/battery low** LED flashes, indicating the phone is changing to another channel.

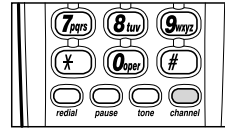

Using the Flash Button

Use the **flash** button for accessing services such as call waiting.

If you receive a call during your conversation, press the **flash** button on the handset. Press the **flash** button again to return to the previous call.

Using the Page/Find Feature

The Page/Find feature sends a signal from the base to the handset causing it to beep. This is useful for locating the handset when it is away from the base. To use this feature, press **page/find** on the base. The handset beeps for 5 seconds. (Press and hold the **page/find** button for more than 2 seconds, to get a continuous beep for a minute.)

If you hold down **page/find** more than a minute, the handset beeps until you release **page/find**. On the handset press **talk** to end the page. Press **talk** again if you do not wish to make a call.

Traveling Out of Range

When you begin to move too far from the base, you will first hear a clicking sound. As you travel further out of range, the voice transmission will begin to break up. If you pass the range limits of the base, your call will terminate.



The paging feature does not work when the phone is in use.

TROUBLESHOOTING

If your TRU 241 cordless telephone is not performing to your expectations, please try these simple steps. If you are still unable to resolve the problems, contact your place of purchase or call customer service at (800) 297-1023.

Caution: Do not attempt to service this unit yourself. Servicing must be performed by qualified personnel.

Problem	Suggestion
The <i>status</i> LED won't come on when handset is placed in base	<ul style="list-style-type: none"> • Make sure the AC adapter is plugged into the base and wall outlet. • Make sure the handset is properly seated in the base. • Make sure the rechargeable battery pack is properly connected in the handset. • Make sure that the charging contacts on the handset and on the base are clean.
The audio sounds weak and/or scratchy	<ul style="list-style-type: none"> • Make sure that the base antenna is in the vertical position. • Interference by other electronic equipment such as TVs, computers, microwave ovens, etc. • You may have gone too far from the base. • Press <i>channel</i> to help eliminate background noise.
Can't make or receive calls	<ul style="list-style-type: none"> • Check both ends of the telephone line cord. • Make sure the AC adapter is plugged into the base and a wall outlet. • Disconnect the AC adapter for a few minutes, then reconnect it. • Reset the security code by placing the handset back on the base for a few seconds. The <i>status</i> LED will blink indicating that the phone has been reset.
Handset doesn't ring or receive a page	<ul style="list-style-type: none"> • The nickel-cadmium battery pack may be weak. • Charge the battery for 15 hours. • The handset may be too far away from the base. • Place the base away from appliances or metal objects. • Reset the security code by placing the handset back on the charging cradle for a few seconds. The <i>status</i> LED will blink indicating that the phone has been reset.
Severe noise interference	<ul style="list-style-type: none"> • Keep the handset away from microwave ovens, computers, remote control toys, wireless microphones, alarm systems, intercoms, room monitors, fluorescent lights, and electrical appliances. • Move to another location or turn off the source of interference.

INSTALLING THE BELTCLIP

To Attach the Beltclip

Insert the beltclip into the holes on each side of the handset.

Press down until it clicks.

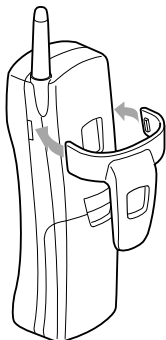

To Remove the Beltclip

Pull both sides of the beltclip to release the tabs from the holes.

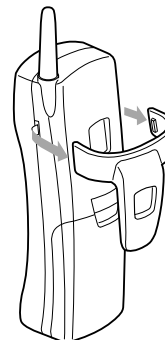

note

If you have wall mounted the base, you cannot place the handset with the keypad facing inside.

HEADSET INSTALLATION

Your phone may be used with an optional headset, the Uniden HS910. To use this feature, simply plug the headset plug into the headset jack on the handset. Your phone is ready for hands-free conversation.

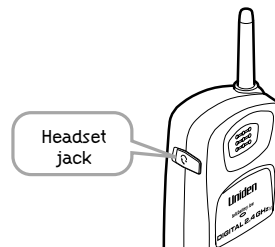

M E M O

M E M O

THANK YOU FOR PURCHASING YOUR UNIDEN CORDLESS PHONE.

A World Without Wires | **Uniden**[®]

Covered under one or more of the following U.S. patents:
4,511,761 4,523,058 4,595,795 4,797,916 5,381,460 5,426,690
5,434,905 5,491,745 5,533,010 5,574,727 5,650,790 5,660,269
5,661,780 5,663,981 5,671,248 5,717,312 5,754,407 5,768,345
5,787,356 5,838,721 5,864,619 5,893,034 5,912,968 5,915,227
5,929,598 5,930,720 5,960,358 5,987,330

©2000 Uniden America Corporation
All rights reserved
UC2201702BZ