

Uniden[®]

TRU 8866

SERIES

OWNER'S

MANUAL

OWNER'S MANUAL

Contents

Welcome/Features/Terminology	2	Joining a Conference Call	36
Controls & Functions	4	Conferencing with one outside line	37
Display and Icons	6	Conferencing with 2 outside lines	37
Soft Key Function	7	Using One Touch Voice Mail Access	38
In standby mode	7	Programming your Voice Mail Access Number	38
In talk mode	7	Setting Voice Mail Tone	39
Setting up the Phone	8	Resetting the New Message LED and Envelope icon	40
A. Choose the best location	8	Find Handset	40
B. Install the rechargeable battery pack into the handset	9	Setting up the Phonebook	41
C. Connect the base unit and charge the handset	10	Storing and Editing Phone Numbers, Names, Distinctive Rings and Speed Dial	41
D. Mount the Base Unit on a Wall	11	Storing a Redial Record	44
Standard wall plate mounting	11	Viewing the Phonebook	45
Direct wall mounting	12	Making Calls Using the Phonebook	46
Expanding Your Phone	13	Speed Dialing	46
Ten Handset Expandability	13	Editing or Erasing a Stored Name, Phone Number, Distinctive Ring and Speed Dial	47
Connect the charger	13	Copying Phonebook Locations	48
Changing the Digital Security Code	14	Caller ID and CIDCW (Caller ID on Call Waiting)	49
Register the Handset	14	Call Waiting Deluxe Features	50
Register the TCX805 and TCX860 expansion handset to main base	15	Viewing the Caller ID List	51
De-register the Handset (Handset only)	15	Deleting Information from the Caller ID List	52
Installing the Beltclip	16	Deleting all Caller ID names/numbers	52
Headset Installation	16	Calling a Party from the Caller ID List	53
Main Menu Options	17	Multi-Handset Features	54
Setting Menu Options	18	Using the DirectLink Mode	54
Using the interface	18	Intercom	56
Global Setup	26	Making an Intercom Page	56
Using Your Phone	29	Answering an Intercom Page	56
Making and Receiving Calls	29	Call Transfer Feature	57
Switching to the Handset Speakerphone During a Call	31	Answering a Call Transfer Page	58
Call Waiting	31	Room/Baby Monitor	59
Placing a Call on Hold	32	Note on Power Sources	60
Redialing a Call	32	General Information	62
Adjusting the Earpiece and Speaker Volume	33	Troubleshooting	63
Muting the Ringer	34	Liquid Damage	65
Do Not Disturb (DND)	34	Precautions & Warranty	66
Temporarily Muting the Ringer	34	I.C. Notice	68
Mute Microphone	34	Index	69
Tone Dialing Switch-over	35	Main Menu Flow Chart	70
Traveling Out of Range	35	Memory List	72
Privacy Mode	36		
Conferencing	36		

Welcome

Congratulations on your purchase of the Uniden Two Line Digital Expandable Cordless Telephone System! This unit is different from conventional cordless telephones. When the base unit is connected to AC power and a telephone line, it can support up to ten handsets. You can now place a fully-featured cordless handset anywhere in your home or office where AC power is available to connect the handset chargers. Extra handsets also allow you to establish a five-way conference call among two handsets, the base speakerphone, and both outside lines.

Note: Illustrations in this manual are used for explanation purposes. Some illustrations in this manual may differ from the actual unit.

As an Energy Star[®] Partner, Uniden has determined that this product or product models meets the Energy Star[®] guidelines for energy efficiency. Energy Star[®] is a U.S. registered mark.



Features

- 5.8GHz Digital Expandable
- Two Line Operation
- Dual Keypad with Caller ID Display at Base
- Ten Multi-Handset Expandability
- Handset and Base Duplex Speakerphones
- Caller ID/Call Waiting Deluxe (subscribe through local telephone company)
- 200 Programmable Memory Locations (100 Handset/100 Base)
- Trilingual Display Options (English, French and Spanish)
- Intercom/Call Transfer Between Handsets or Handset and Base
- 20 Distinctive Ring Options (ten ringer tones and ten melody ringers)
- Mute and Hold Features
- Do Not Disturb (DND) Feature
- DirectLink™ Mode
- Room/Baby Monitoring
- Battery Level Indicator
- Clock Display
- Animation Displays
- Line 1 and Line 2 Displays

This series features **AutoTalk™** and **AutoStandby™**. AutoTalk allows you to answer a call by just removing the handset from the cradle so you don't have to waste time pushing buttons. AutoStandby allows you to hang up by simply returning the handset to the cradle.

To protect you against mis-billed calls that might result from your phone being activated by other equipment, this series has **Random Code™** digital security, which automatically selects one of more than 10,000,000 digital security codes for the handset and base.

Digital Spread Spectrum Technology uses a wider frequency band than standard digital transmissions. The result is a more secure conversation with the clarity of digital sound, extended range, and minimal interference from other cordless phones.

IntegriSound™ Built in sound quality which provides life-like conversations.

With **DirectLink™** mode, you can use two or more handsets as radio tranceivers (walkie-talkies).

Be sure to visit our web site: www.uniden.com

Uniden® is a registered trademark of Uniden America Corporation.

AutoTalk, AutoStandby, DirectLink, IntegriSound and Random Code are trademarks of Uniden America.

Terminology

- **Standby Mode** - The handset maybe sitting or off the cradle, but is NOT in use. **talk/flash**, **speaker**, or the **LINE1** or **LINE2** soft key has not been pressed. No dial tone is present.
- **Talk Mode** - The handset is not in the cradle, and **talk/flash**, **speaker**, or the **LINE1** or **LINE2** soft key has been pressed and enabling a dial tone.

Controls & Functions

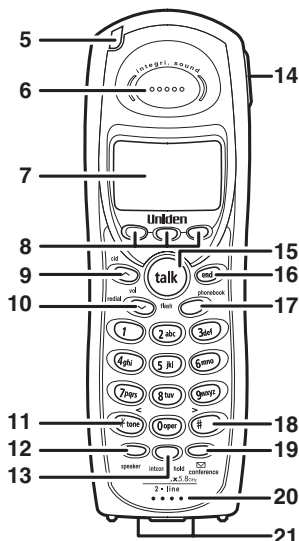
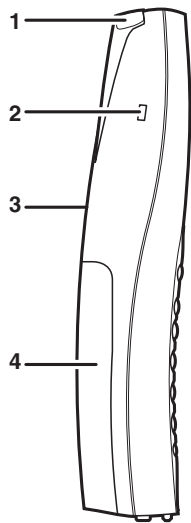

1. Handset Antenna
2. Beltclip Hole
3. Speakerphone Speaker and Ringer
4. Handset Battery Compartment
5. New Message LED
6. Handset Earpiece
7. LCD Display
8. **soft** Keys (P. 7)
9. **vol** \wedge (volume up)/**cid** (P. 33, 18, and 51)
10. **vol** ∇ (volume down)/**redial/p** (P. 33, 18, 32, and 29)
11. ***/tone/<** (P. 35 & 42)
12. **speaker** (P. 31)
13. **intcom/hold** (P. 56 & 32)
14. Headset Jack Cover
15. **talk/flash** (P. 29 & 31)
16. **end** (P. 31)
17. **phonebook** (P. 41)
18. **#/>** (P. 42)
19. **conference/**  (P. 37 & 38)
20. Handset Microphone
21. Handset Charging Contacts

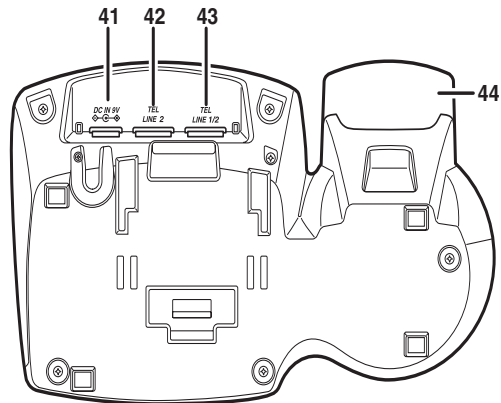
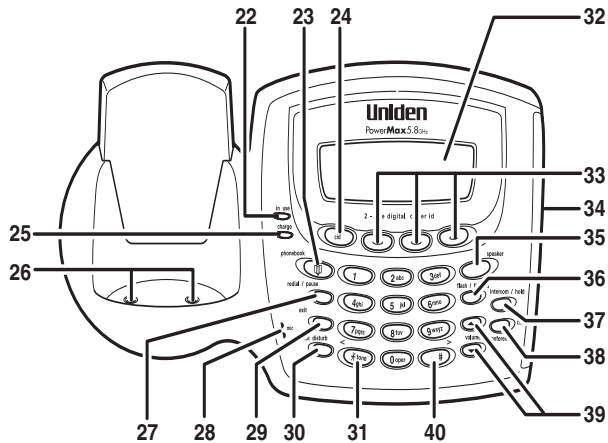

- 22. in use LED
- 23. **phonebook** (P. 41)
- 24. **cid** (P. 51)
- 25. charge LED
- 26. Base Charging Contacts
- 27. **redial/pause** (P. 32 & 30)
- 28. **mic** (microphone)
- 29. **exit** (P. 45)

- 30. **do not disturb** /DND LED (P. 34)
- 31. **tone** < (P. 35 & 42)
- 32. LCD Display
- 33. **soft** Keys (P. 7)
- 34. Base Speaker
- 35. **speaker**/speaker LED (P. 30)
- 36. **flash/find hs** (P. 31 & 40)
- 37. **intercom/hold** (P. 56 & 32)

- 38. **conference** (P. 37 & 38)
- 39. **volume** (volume up/down) (P. 33 & 18)
- 40. **# >** (P. 42)
- 41. **DC IN 9V** Jack
- 42. **TEL LINE 2** Jack
- 43. **TEL LINE 1/2** Jack
- 44. Base Antenna

Display and Icons

Example of the standby mode display

- **Handset**



Ringer off icon (when the ringer is off)/ day of the week and time / battery icon
 Handset ID and Banner
 Number of new Caller ID calls received (If there are no new Caller ID messages, the Handset ID appears here.)

- **Base**

* Ringer Volume Level —



Day of the week and time and envelope icon
 Number of new Caller ID calls received

* This icon changes depending on ringer volume level (High, low and off)

ICON	Appears During	DESCRIPTION
	Standby/Talk	Battery icons indicate the handset battery status. This icon changes depending on the battery status (empty, low, medium and full).
	Standby	The Ringer off icon indicates that ringer is turned off.
	Standby/Talk	The Line icon indicates the line in use or the line received a new Caller ID message (Line1 and/or Line2).
	Talk	The Mute icon appears when you mute the handset or base.
	Talk	The Speaker icon appears when the handset speaker phone is used (handset only).
	Talk	The Privacy icon appears when the Privacy Mode is turned on.
	Standby	When a new message is received, an envelope icon is displayed on the LCD screen (base only).

Soft Key Function

"Soft" keys are keys that change function during the operation of the phone. There are three soft keys on the base and three on each handset. Soft keys allow you to:

- Access the main menu
- Store or edit phone numbers or Caller ID messages

The function of each soft key is determined by the icon that appears directly above it. For example, when the handset is in standby mode, pressing soft key 1 activates Line1. When the handset is in talk mode, pressing soft key 1 will mute the microphone. Complete information on the features controlled by the soft keys can be found under each feature.

In standby mode Handset

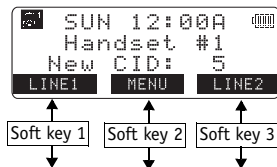

Base

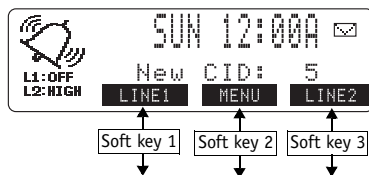

In talk mode Handset



Base



Setting up the Phone

A. Choose the best location

When choosing a location for your new phone, here are some important guidelines you should consider:

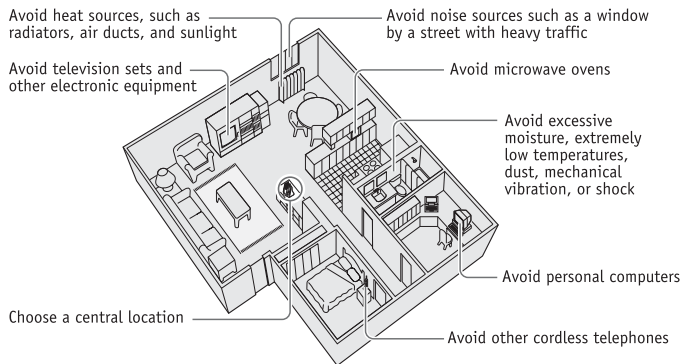

- The location should be close to both a phone jack and a continuous power outlet (one which is not connected to a switch).
- The base and handset should be kept away from sources of electrical noise such as motors, microwave ovens, and fluorescent lighting.
- For better reception, place the base as high as possible.
- The base should be placed in an open area for optimum range and reception.
- If your home has specially wired alarm equipment connected to phone line, be sure that installing the system does not disable your alarm equipment. If you have questions about what will disable alarm equipment, contact your telephone company or a qualified installer.



For maximum range:

- Keep the antenna free of obstruction.
- When the handset is not in use, place it in an upright position.
- Do not hold the handset where you would block the signal.

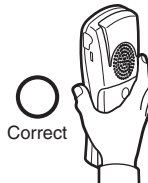

- Metal and reinforced concrete may affect cordless telephone performance.



•Use only the Uniden (BT-446) rechargeable battery pack supplied with your cordless telephone.

•Replacement battery packs are also available through the Uniden Parts Department at (800) 554-3988, Monday thru Friday from 8:00 a.m. to 5:00 p.m. or online at www.uniden.com

B. Install the rechargeable battery pack into the handset

The handset is powered by a rechargeable battery pack. The battery recharges automatically when the handset is placed in the base unit.

- 1) Press down on the handset battery case cover (use the finger indentation for a better grip) and slide the cover downward to remove.
- 2) Plug the battery connector (red & black wires) into the jack inside the battery compartment. (The connector notches fit into the grooves of the jack only one way). Match the wire colors to the polarity label in the battery compartment, connect the battery and listen for a click to insure connection.
- 3) Make sure you have a good connection by gently pulling on the battery wires. If the connection is secure, the battery jack will remain in place.
- 4) Place the battery case cover back on the handset and slide it upwards until it clicks into place.

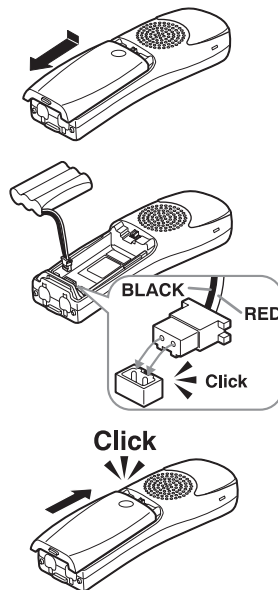

C. Connect the base unit and charge the handset

- 1) Connect the AC adapter to the **DC IN 9V** jack and to a standard 120V AC wall outlet.

Note:

- Connect the AC adapter to a continuous power supply (i.e., an outlet that is not controlled by a switch).
- Place the base unit close to the AC outlet so that you can unplug the AC adapter easily.

- 2) Place the handset in the base unit with the keypad facing forward.

- 3) Make sure that the **charge** LED illuminates. If the LED does not illuminate, check to see that the AC adapter is plugged in and the handset makes good contact with the base charging contacts.

- 4) Charge your handset at least **15-20 hours before plugging into the phone line.**

- 5) Once the handset battery pack is fully charged, connect the telephone line cords to the **TEL LINE 1/2** jack and to a telephone outlets.



If your telephone outlet isn't modular, contact your telephone company for assistance.

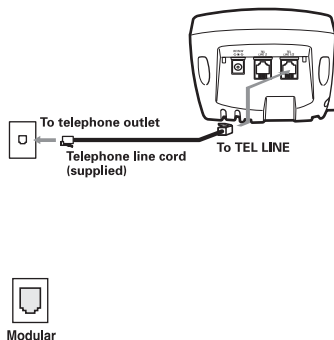
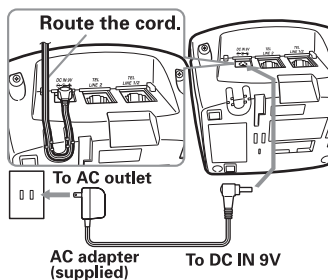

- Use only the supplied **AD-0006 AC adapter.** Do not use any other AC adapter.
- Do not place the power cord where it create a trip hazard or where it could become chafed and create a fire or electrical hazard.

For 2 line subscriptions,

- If the two phone lines are in one modular jack, connect using **TEL LINE 1/2** jack.
- If the two phone lines are on two separate modular jacks, connect using both **TEL LINE 1/2** and **TEL LINE 2** jacks.

D. Mount the Base Unit on a Wall

Standard wall plate mounting

This phone can be mounted on any standard wall plate.

- 1) Make the AC adapter and the telephone line cords through the hole on the wall mount adapter.
- 2) Plug the AC adapter into the **DC IN 9V** jack.
- 3) Plug the telephone line cords into the **TEL LINE2** jacks.
- 4) Slide the wall mount adapter into the notches on the base.
- 5) Plug the AC adapter into a standard 120V AC wall outlet. Hook the cord on the notch of the wall mount adapter.
- 6) Plug the telephone line cords into the telephone outlets. Hook the cords on the notches of the wall mount adapter.
- 7) Align the mounting slots on the base with the mounting posts on the wall. Then push in and down until the phone is firmly seated.

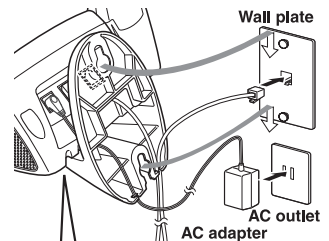
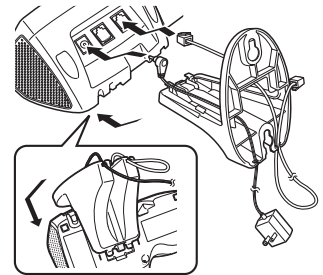

Direct wall mounting

If you don't have a standard wall plate, you can mount your phone directly to the wall. Before doing this, consider the following:

- Avoid electrical cables, pipes, or other items behind the mounting location that could cause a hazard when inserting screws into the wall.
- Try to mount your phone within 5 feet of a working phone jack to avoid excessive lengths.
- Make sure the wall material is capable of supporting the weight of the base and handset.
- Use #10 screws (minimum length of 1 & 3/8 inches) with anchoring devices suitable for the wall material where the base unit will be placed.

1) Insert two mounting screws into the wall (with their appropriate anchoring device), 3 & 15/16 inches apart. Allow about 1/8 of an inch between the wall and screw heads for mounting the phone.

2) Refer to steps 1 through 7 on page 11 to mount the telephone.

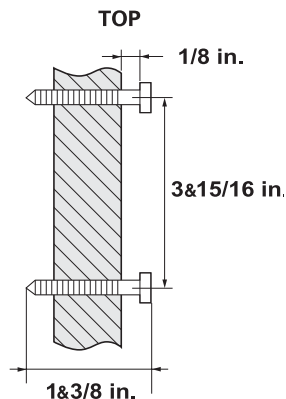



IMPORTANT

If you purchase a TCX805 and TCX860 extra handset, please register the handset to the original/main base before use. The TCX805 and TCX860 will not operate until it is registered.

If you change a global setting in one handset, you change that particular setting for all registered handsets. All other settings (not included under Global Setup) must be set separately through each handset.

Expanding Your Phone

Ten Handset Expandability

Your phone supports up to ten handsets, including any handsets supplied with your phone. You can now place a fully-featured cordless handset anywhere AC power is available to connect the handset charger. Handsets can be used in DirectLink Mode or on an intercom call without interfering with incoming calls. It is possible to have a five-way conference among the base, two handsets, and both outside lines. All of the handsets ring when a call is received.

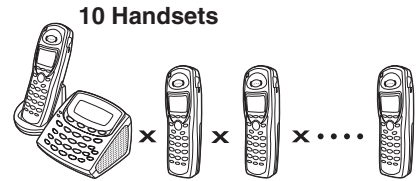

Connect the charger

The handset is powered by a rechargeable battery pack. The battery recharges automatically when the handset is placed in the charger.

- 1) Connect the AC adapter to the DC IN 9V jack and to a standard 120V AC wall outlet.
- 2) Set the charger on a desk or tabletop, and place the handset in the charger with the keypad facing forward.
- 3) Make sure that the **charge** LED illuminates. If the LED does not illuminate, check to see that the AC adapter is plugged in and the handset makes good contact with the base charging contacts.

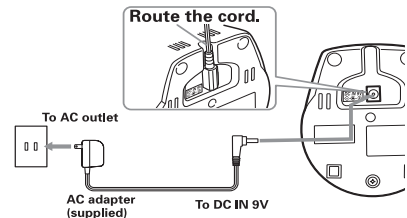

- 4) Charge the handset battery pack for at least 15-20 hours before using your new cordless telephone for the first time.

Changing the Digital Security Code

The digital security code is an identification code used to connect the handset and the base unit. Normally, setting the code is not necessary. In the rare situation that you suspect another cordless telephone is using the same security code, you can change the code. To change the digital security code:

- 1) De-register all the handsets you have (see “De-register the Handset (Handset only)” on page 15).
- 2) Register the handsets by following step 2-3 in “Register the Handset” on page 14.

Register the Handset

If you purchase an extra handset, you need to register the handset before use. Only one handset can be registered at a time.

Handsets supplied with the phone are registered to the base by the factory. When charged, pre-registered handsets display a handset ID number. Handsets that have not been registered display Models vary! Charge handset on the base for registration or refer to Owner's Manual. When you register an extra handset to the base, the handset ID will be assigned.



If a handset has ever been registered to a different base, you must de-register the handset before you can register it to the new base (see page 15).

Register the TCX805 and TCX860 expansion handset to main base

Before an expansion handset is registered, the battery pack **MUST** be charged for **15 hours**.

To register TCX805 or TCX860 handset, simply place it in the main base.

While the handset is registering, `Handset Registering` will appear in the LCD. When `Registration complete.` is displayed, the handset has been registered to the base. If `Registration failed.` appears, please try these steps again.

De-register the Handset (Handset only)

You can deregister the handset's ID from the main base unit or the base ID from the handset. You will usually only deregister the handset if you are going to use it with a different base, if you are having a problem with your phone or if you need to change the digital security code (see page 14).

- 1) Press the **MENU** soft key. Select the Deregister HS in the menu and press the **OK** soft key. `Deregister HS?` appears.
- 2) Press **vol/ ^/cid** or **vol/ v/redial/p** to select `Yes` and then the **OK** soft key.
When de-registration is complete you will hear a confirmation tone, and `Deregistration Complete` appears.
- 3) After de-registering the handset, place the handset to the base to register. You must re-register the handset before you can use it.



Installing the Beltclip

To attach the beltclip

Insert the beltclip into the holes on each side of the handset.
Press down until it clicks.

To remove the beltclip

Pull either side of the beltclip to release the tabs from the holes.



Headset Installation

Your phone may be used with an optional headset. To use this feature, insert the headset plug into the headset jack. Your phone is ready for hands-free conversations. (Headset may be purchased by calling the Uniden Parts Department or visiting the web site. See page 62.)



- For Global Setup, and Deregister HS menu options, when setting options from the handset, make sure the line is not in use and the handsets are within range of the base.
- Main menu flow chart is provided on page 70.

Main Menu Options

Your phone has six main menu options: **DirectLink Mode**, **Room/Baby Monitor**, **Handset Setup**, **Base Setup**, **Global Setup** and **Deregister HS**. You can change **Room/Baby Monitor**, and **Global Setup** settings from the base or from any handset. **DirectLink Mode**, **Handset Setup**, and **Deregister HS** are only available from a handset. **Base Setup** is only available from the base.

Default Settings

The default settings set from the factory match the features that most people use. You may not need to change them. However, there are a number of options you must set and entries you must make in memory to take full advantage of all the phone features. The table below lists the default settings.

Function	Handset	Base	Function	Handset	Base
Set TEL-LINE		Auto	LCD Contrast		level 5
Edit Voice Mail		None	Key Touch Tone	On	
Ringer Volume		High	Animation Screen	On	-
Ringer Tones	L1: Flicker	-	Room Monitor		On
	L2: Clatter	-	Day & Time		SUN 12:00 AM
Distinctive Ring	On	-	CIDCW		CW on/CWDX off
Auto Talk	Off	-	Area Code		None
Anykey Answer	Off	-	Dial Mode		Tone
Banner	" "	-	Voice Mail Tone		On
Language (LCD)		English			

Setting Menu Options

Using the interface

Below are some tips for using the software interface on your phone.

- Press the **MENU** soft key to access the main menu.
- Use **volume up/down** to scroll through options.
- Press the **OK** soft key to make a selection.
- Press the **BACK** soft key to return to the previous screen.
- Press **end** on the handset or **exit** on the base to exit the menu.
- If you do not press a key within 30 seconds, the phone will time out and exit the menu mode. When setting Day and Time, the time-out period is extended to two minutes.

•Handset



•Base



Handset Setup / Base Setup

The following submenu options must be set separately for each handset and the base.

Selecting a Telephone Line

TEL-LINE allows you to set default telephone line. The line you select will be used when you make a call. If you select `Auto`, the phone will default to whichever line is currently free.

- 1) Press the **MENU** soft key. Select the Handset Setup menu or the Base Setup Menu, and then the Set TEL-LINE submenu.
- 2) Press **volume up/down** to select `Auto`, `Line1`, or `Line2`.
- 3) Press the **OK** soft key. You will hear a confirmation tone.



Selecting a Ringer Volume

Ringer Volume lets you select one of three ringer volume (Off, Low, or High).

- 1) Press the **MENU** soft key. Select the Handset Setup menu or the Base Setup Menu, and then the Ringer Volume submenu.
- 2) Press **volume up/down** to select `L1` or `L2`, and then press the **OK** soft key.

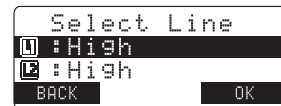

- 3) Press **volume up/down** to adjust the ringer settings (Ringer Volume Off, Ringer Volume Low, or Ringer Volume High). You will hear a ringer or melody at the Selected volume (if you select Ringer Volume Off, no ringer or melody will sound).
- 4) Press the **OK** soft key. You will hear a confirmation tone.

Selecting a Ringer Tone (Handset only)

Ringer tone lets you choose from 10 ringer tones or 10 melodies:

- Ringers (Flicker, Clatter, Soft Alert, Wake Up, Light Bug, Beep Boop, Tone Board, Chip Chop, Party Clap, Reminder)
 - Melodies (Beethoven's Symphony #9 [Beethoven9], For Elise [Elise], We Wish You A Merry Christmas [Merry- Xmas], Home Sweet Home [Hm Swt Hm], Lorri Song #6 [Lorri Song], When the Irish Eyes Are Smiling [Irish Eyes], Aura Lee, Let Me Call You Sweet Heart [Sweetheart], Star Spangled Banner [Star Spngl], Old MacDonald [Old MacDld])
- You must set a separate ringer tone on the base and each handset.

- 1) Press the **MENU** soft key. Select the Handset Setup menu, and then the Ringer Tones submenu.
- 2) Press **vol/ ^/cid** or **vol/ v/redial/p** to select L1 or L2, and then press the **OK** soft key.
- 3) Press **volume up/down** to move the pointer. You will hear the ringer or melody as you scroll through the options.
- 4) Press the **OK** soft key. You will hear a confirmation tone.

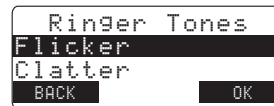

Distinctive Ringer Setup (Handset only)

Distinctive Ringer allows you to assign a designated ring tone to a stored phonebook number. When a call is received and the Caller ID information matches the information in one of the phonebook memory entries, the phone uses the distinctive ring assigned to that particular caller. You can assign distinctive rings to multiple phonebook memory entries. Switching the setting to Distinctive Off disables distinctive ringing: all incoming calls will have a normal ring tone. Switching to Distinctive On activates all programmed distinctive rings.

- 1) Press the **MENU** soft key. Select the Handset Setup menu, and then the Distinctive Ring submenu.
- 2) Press **volume up/down** to select On or Off.
- 3) Press the **OK** soft key. You will hear a confirmation tone.

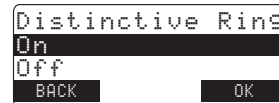

Setting AutoTalk (Handset Only)

AutoTalk allows you to answer the phone simply by removing the handset from the cradle. You do not have to press any buttons to answer the call.

- 1) Press the **MENU** soft key. Select the Handset Setup menu, and then the AutoTalk submenu.
- 2) Press **vol/∧/cid** or **vol/∨/redial/p** to select On or Off.
- 3) Press the **OK** soft key. You will hear a confirmation tone.



Setting Anykey Answer (Handset only)

Anykey Answer allows you to answer the phone by pressing any number key, **/tone/<*, or *#/>* on the handset.

- 1) Press the **MENU** soft key. Select the Handset Setup menu, and then the Anykey Answer submenu.
- 2) Press *vol/∧/cid* or *vol/∨/redial/p* to select On or Off.
- 3) Press the **OK** soft key. You will hear a confirmation tone.



Setting the True Banner (Handset only)

True Banner lets you customize the name your handset displays. The name will be displayed on the LCD screen during Standby Mode, Intercom, Intercom Hold, Room Monitor, DirectLink Mode and Copy Phonebook operation. The banner name will be displayed on the receiving handset as well.

- 1) Press the **MENU** soft key. Select the Handset Setup menu, and then the Banner submenu.
- 2) Use the number keypad (0-9), **/tone/<*, *#/>*, or the **DELETE** soft key to enter or edit the name.
- 3) Press the **OK** soft key. You will hear a confirmation tone.

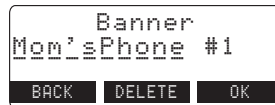

Selecting a Language

You can change the language the menu display will use. Choose from English, French, or Spanish.

- 1) Press the **MENU** soft key. Select the Handset Setup menu or the Base Setup menu, and then the Language submenu.
- 2) Press **volume up/down** to choose "English," "Français" (French), or "Español" (Spanish).
- 3) Press the **OK** soft key. You will hear a confirmation tone.



Adjusting the LCD Contrast

Contrast adjusts the handset and base LCD brightness. Choose one of the 10 levels for optimum viewing.

- 1) Press the **MENU** soft key. Select the Handset Setup menu or the Base Setup menu, and then the LCD Contrast submenu.
- 2) Press **volume up/down** to adjust the contrast of the LCD (10 levels.)
- 3) Press the **OK** soft key. You will hear a confirmation tone.



Setting the Key Touch Tone (Handset only)

Key Touch Tone is the tone your keypad makes when keys are pressed. You can turn this tone on or off.

- 1) Press the **MENU** soft key. Select the Handset Setup menu, and then the Key Touch Tone submenu.
- 2) Press **vol/∧/cid** or **vol/∨/redial/p** to select **On** or **Off**.
- 3) Press the **OK** soft key. You will hear a confirmation tone.



Setting the Animation Screen (Handset Only)

The Animation Screen displays animation on the handset LCD. The animations will be displayed on the LCD screen during ringer volume setting, paging operation, when you hang up and so on.

- 1) Press the **MENU** soft key. Select the Handset Setup menu, and then the Animation Screen submenu.
- 2) Press **vol/∧/cid** or **vol/∨/redial/p** to select **On** or **Off**.
- 3) Press the **OK** soft key. You will hear a confirmation tone.



The handsets have a variety of animation displays. Below are examples of the animation screens and what they mean:

Turning on the phone



Hanging up the phone



Confirmation (Done!)



Find Handset/Paging the Handset



Deleting (Deleted!)



Also, the animation display changes depending on the ringer volume setting.



Out of Range



Unavailable



Low Battery

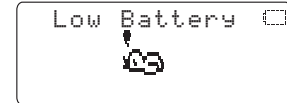

Global Setup

If you change one of the global settings, you change that setting for all registered handsets and the base. Only one handset or the base can change global settings at a time.

Setting Day and Time

Day & Time sets the day and time of your display.

- 1) Press the **MENU** soft key. Select the Global Setup menu, and then the Day & Time submenu option.
- 2) Press **volume up/down** to select the day of the week, and then the → soft key.
- 3) Press **volume up/down** to set hour, and then press the → soft key.
- 4) Press **volume up/down** to set minute, and then press the → soft key.
- 5) Press **volume up/down** to choose AM or PM, and then press the **SAVE** soft key. You will hear a confirmation tone.



If no key is pressed for two minutes, the phone will exit the menu mode.

Setting CIDCW (Caller ID on Call Waiting)

CIDCW sets the Caller ID on Call Waiting (CIDCW) displays the name and number of an incoming call while you are on the line. Call Waiting Deluxe (CWDX) allows you to handle call waiting calls in seven different ways.

- 1) Press the **MENU** soft key. Select the Global Setup menu, and then the CIDCW submenu.
- 2) Press **volume up/down** to select L1 or L2, and then press the **OK** soft key.
- 3) Press **volume up/down** to select CW On/CWDX On, CW On/CWDX Off, or CW Off/CWDX Off and then press the **OK** soft key. You will hear a confirmation tone.



Setting the Area Code

If you enter a 3-digit area code number in the "Area Code" option, your local area code does not appear in the Caller ID message. When calls are received from outside your local area code, you will see a full 10-digit number.

- 1) Press the **MENU** soft key. Select the Global Setup menu, and then the Area Code submenu.
- 2) Press **volume up/down** to select L1 or L2, and then press the **OK** soft key.
- 4) Use the number keypad (0-9) to enter a 3-digit area code. If an area code has already been stored, it will appear in the display. Press the **DELETE** soft key to delete the stored code, then enter a new one.
- 5) Press the **OK** soft key. You will hear a confirmation tone.

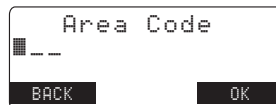

Setting the Dial Mode

Dial Mode sets the dial mode to tone or pulse. Most phone systems use tone dialing; the default setting is tone dialing. Set the dialing mode to match the dialing system used by your local phone service.

- If you are not sure of your dialing system, make a trial call. If the call connects, leave the setting as is; otherwise set the unit to pulse dialing.
- If your phone system requires pulse dialing and you need to send DTMF tones in certain situations during a call, you may switch over to tone dialing (refer to "Tone Dialing Switch-over" on page 35).

- 1) Press the **MENU** soft key. Select the Global Setup menu, and then the Dial Mode submenu.
- 2) Press **volume up/down** to select L1 or L2, and then press the **OK** soft key.
- 3) Press **volume up/down** to select **Tone** or **Pulse** (the initial setting is **Tone**).
- 4) Press the **OK** soft key. You will hear a confirmation tone.

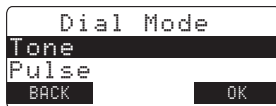



- To set "Autotalk," see page 21 or to set "Anykey Answer" see page 22.
- If the line(s) is already in use, the base and all registered handsets that are not currently in use will display "InUse" with corresponding line icon.
- To have the phone select Line 1 or Line 2 instead of a free line, set the default telephone line (see page 19).

Using Your Phone

Making and Receiving Calls

If you subscribe to two phone lines, those lines will be completely independent on your phone. For example, you can have one handset talking on Line 1 while another handset and the base unit participate in a 3-way conference on Line 2. You must have a 2-line subscription from your phone company to use the 2-line features.

Making a call From the handset

- 1) Remove the handset from the base.
- 2) Press **talk/flash**. The phone will automatically select a free line. To select a particular line, press the **LINE1** or **LINE2** soft key.
- 3) Listen for the dial tone.
- 4) Dial the number.



OR

- 1) Remove the handset from the base.
- 2) Dial the number.
If pause is required, press **vol/√/redial/p**. P appears in the display, which represents a pause.
- 3) Press **talk/flash**. The phone will automatically select a free line. To select a particular line, press the **LINE1** or **LINE2** soft key.

From the Handset Speakerphone

- 1) Remove the handset from the base.
- 2) Press **speaker**.
- 3) Listen for the dial tone.
- 4) Dial the number.
- 5) When the other party answers, talk into the microphone.

From the base

- 1) Press **speaker**. The phone will automatically select a free line. To select a particular line, press the **LINE1** or **LINE2** soft key.
- 2) Listen for the dial tone.
- 3) Dial the number.



OR

- 1) Dial the number. If pause is required, press **redial/pause**.
- 2) Press **speaker**. The phone will automatically select a free line. To select a particular line, press the **LINE1** or **LINE2** soft key.

Receiving a call

From the handset

- 1) Remove the handset from the base. (If AutoTalk is on, the phone will automatically answer the call when you pick it up.)
- 2) Press **talk/flash** or the corresponding soft key (**LINE1** or **LINE2**).



- The handset microphone is located at the bottom of the handset.
- For best performance, use the speaker phone in a quiet room and let the caller finish speaking before you speak. If you or the other party has difficulty hearing, adjust the speaker volume.
- When using the base speaker, position yourself as near to the base as possible and speak clearly.
- To have the phone select Line 1 or Line 2 instead of a free line, set the default telephone line (see page 19).



OR

If the handset is off the base, press **talk/flash** or the correspond soft key (**LINE1** or **LINE2**). If Any Key Answer is on, you can also press any key on the number keypad.

From the base

Press **speaker** or the correspond soft key (**LINE1** or **LINE2**).



Hanging Up

From the handset, press **end** or return the handset to the base.

From the handset speakerphone, press **end** or return the handset to the base.

From the base, press **speaker**.

Switching to the Handset Speakerphone During a Call

To switch a normal call to the speakerphone, press **speaker** on the handset. To switch from a speakerphone call to a normal call, press **speaker**.

Call Waiting

If you have Call Waiting service and a call waiting tone sounds while you are on a call, press **talk/flash** on the handset or **flash/find hs** on the base to accept the waiting call. There is a short pause, and then you will hear the new caller. To return to the original caller, press **talk/flash** on the handset or **flash/find hs** on the base again.

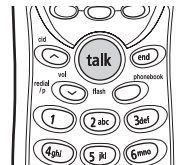

You must subscribe through your local telephone company to receive Call Waiting or Caller ID on call waiting service.

Placing a Call on Hold

- 1) During a call, press **intcom/hold** on the handset or **intercom/hold** on the base. The line soft key (**LINE1** or **LINE2**) to be placed on hold will flash. The call will be put on hold.



If you leave a call on hold for more than 10 seconds, the display screen will read Hold.

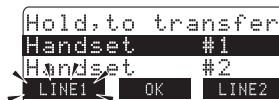

- 2) To talk to the caller, press **talk/flash** or **speaker** on a handset (or **speaker** on the base). The phone will return back to the call.

Redialing a Call

The last three phone numbers dialed can be quickly redialed from the handset or base.

- 1) With the phone in standby mode, press **vol/√/redial/p** (or **redial/pause** on the base) in standby mode.
- 2) Press **volume up/down**. Each press of **volume up/down** will display one of the last three number redialed.
- 3) Press **talk/flash** or **speaker** on the handset (or **speaker** on the base). The selected number is dialed.
- 4) To hang up, press **end** (or **speaker** on the base).

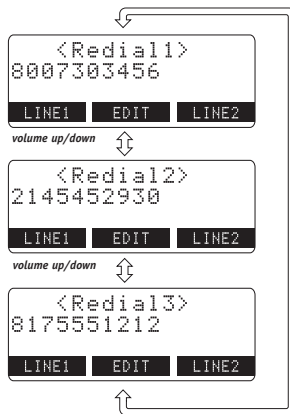

- You can place a call on hold for 15 minutes. When 15 minutes has passed, the call is disconnected, and the phone returns to standby mode.
- While a call is on hold, CIDCW can not be received.
- If the number exceeds 32 digits, only the first 32 digits are retained in redial memory.
- If the redial memory is empty, you will hear a beep.
- Redial numbers stored in the handset and the base are independent from each other.
- To store or delete redial numbers in the Phonebook, see page 44.

You can also display the redial list for redial number with the handset in talk mode. Press the **MENU** soft key, then select the redial menu. Press **volume up/down** to select the number you want to dial. Press the **DIAL** soft key to redial number.

Deleting a Redial Record

- 1) With the phone in standby mode, press **vol/√/redial/p** (or **redial/pause** on the base).
- 2) Press **volume up/down** repeatedly to display the number to be deleted.
- 3) Press the **EDIT** soft key.
- 4) Press **volume up/down** to choose **Delete?** and then press the **OK** soft key.
- 5) Press **volume up/down** to choose **Yes**.
- 6) Press the **OK** soft key. The redialed number is deleted.



Adjusting the Earpiece and Speaker Volume

You can select from among six volume levels on the handset and ten volume levels on the base. During a call, press the volume up key or volume down key on the handset or base to change the earpiece or speaker volume. This setting will remain in effect after the telephone call has ended.

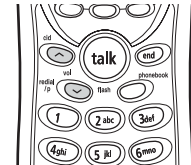

If you press the volume up key when the earpiece is at the maximum volume level, an error tone sounds. The error tone also sounds if you press the volume down key at the lowest volume.

Muting the Ringer

Do Not Disturb (DND)

The do not disturb feature (DND) allows you to mute the ringer on the base and any registered handsets at the same time. The phone must be in standby mode. Press and hold **do not disturb** on the base. You will hear a confirmation tone, and the **DND** LED illuminates. To cancel the DND feature, press **do not disturb** again. You can also mute the ringer tone while the phone is ringing by pressing **do not disturb** on the base.

Temporarily Muting the Ringer

To mute the ringer tone temporarily for each handset or the base, when the phone is ringing, press **end** or the **MUTE** soft key on the handset you want to mute or the **MUTE** soft key on the base. The mute will last for the current incoming call only. The ringer tone will return to the previous setting starting with the next incoming call.

Mute Microphone

With the handset

You can temporarily mute the microphone so that the caller cannot hear you. Press the **MUTE** soft key during talk mode (while the phone is in use) to mute the microphone. **Mute On** and  appear in the display. To cancel muting, press the **MUTE** soft key again. **Mute Off** appears.



note

While charging a handset, you can not mute the ringer tone for the handset.

With the base

While using the base speakerphone, press the **MUTE** soft key on the base to mute the microphone. *Mute On* and  appear in the display. To cancel muting, press the **MUTE** soft key again or press *speaker*. *Mute Off* appears.

Tone Dialing Switch-over

If your telephone company requires pulse dialing, you can switch-over to tone dialing after the call connects. This feature is useful when you need tone dialing to use any automated menu systems, such as telephone bank tellers, telephone prescription refills, customer support menus, etc.

If your phone is set to pulse dialing mode, make your call normally. Once your call connects, press the **/tone/*< key. Any digits you enter from then on will be sent as tone digits. When this particular call ends, the phone automatically returns to pulse dialing mode.

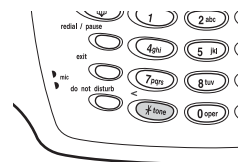
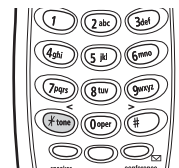

Traveling Out of Range

During a call, as you begin to move your handset too far from your base unit, noise may increase. If you pass the range limits of the base unit, you will hear a beep and see *Out of Range* on the display, and then the handset returns to standby mode.

Privacy Mode

Privacy mode prevents interruption from other registered handsets or the base. **This works only when the phone is in use.**

On the base

While you are talking on the phone, press the **PRIVACY** soft key. If you do not see the **PRIVACY** soft key (for example, if you have Call Waiting Deluxe enabled), follow the steps for the handset, below.

On the handset

- 1) While you are talking on the phone, press the **MENU** soft key.
- 2) Use the **volume up/down** keys to select Privacy Mode, then press the **OK** soft key.

Privacy Mode On and  appear in the display. To exit Privacy Mode, simply repeat the same steps. Privacy Mode Off appears.

Conferencing

If you have more than one handset, up to five people can participate in a conference call. A five-way conference call consists of Outside Line 1 + Outside Line 2 + Base + Two Handsets. Only two handsets can participate in any conference call.

Joining a Conference Call

You can easily join a call already in progress.

From the base

- 1) Press corresponding soft key (**LINE1** or **LINE2**) on the base to join the conference call.
- 2) To hang up, press **speaker** on the base. The handset(s) will still be connected to the call.

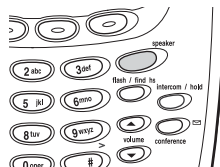

If another handset or the base is in Privacy Mode, you cannot join the call. If someone is using the handset or base in Privacy Mode, Unavailable appears in the display when you try to join the call.

From a second handset

- 1) Press corresponding soft key (**LINE1** or **LINE2**) on the handset to join the call.
- 2) To hang up, return the handset to the cradle, or press **end** on the handset. The base or other handset will still be connected to the call.



Conferencing with one outside line

To hold a conference call with one outside line, simply have the handsets or base join the call.

Conferencing with 2 outside lines

Follow the steps below to allow both outside lines to participate in a conference call:

- 1) During a call, press **intcom/hold** on the handset or **intercom/hold** on the base to put the first caller on hold.
- 2) Press the line soft key (**LINE1** or **LINE2**) for a free line to make or answer a second call.
- 3) When the second call is connected, press **conference** to initiate a conference call.
- 4) To disconnect a single caller, press the corresponding soft key (**LINE1** or **LINE2**) to place the caller you wish to keep speaking to on hold and then press **end** on the handset or **speaker** on the base to hang up the other caller. For example, to hang up Line 2 but leave Line 1 connected:
 - Press the **LINE2** soft key to put Line 1 on hold.
 - Press the **END** soft key to hang up Line 2.
 - Press the **LINE1** soft key to take Line 1 off hold and continue the conversation.To hang up both lines, press **end** on the handset (or **speaker** on the base).

Using One Touch Voice Mail Access

If you subscribe to voice mail service, you can use your phone to access your voice mailbox. The New Message LED flashes on the handset and  icon appears on the base whenever you have messages waiting in your voice mailbox.

Just program the phone with your access number, and you can get your messages at the touch of a button. (The voice mail service provider will supply you with the access number. This number may be simply a phone number. Refer to the provider's literature).

When you have messages, press  . The line icon (L1 or L2) which has the message appears. Press the correspond soft key (**LINE1** or **LINE2**) to access your voice mailbox.



note

- You must subscribe to voice mail service from your telephone company in order to use this feature. The voice mail service company will provide you with the access number.

Programming your Voice Mail Access Number

Edit Voice Mail No. allows you to program or delete the voice mail access number.

- 1) Press the **MENU** soft key. Select the Handset Setup or Base Setup menu, and then the Edit Voice Mail submenu.
- 2) Press **volume up/down** to select L1 or L2, and then press the **OK** soft key. Edit V_mail No. appears.



- 3) Use the number keypad to enter your personal access number (up to 20 digits). If you have an access number already entered, the current number will appear in the display. To delete that number, press the **DELETE** soft key, then the **OK** soft key.
- 4) If you need to have the phone wait before sending the next digits, press **redial /p** (or **redial/pause** on the base). A P appears in the display each time you press **redial /p** (or **redial/pause** on the base); each pause inserts a two-second delay in the dialing sequence, and each pause counts as one digit.
- 5) Press the **OK** soft key. You will hear the confirmation tone.

Setting Voice Mail Tone

There are two types of signals the phone company can use to tell your phone you have a voice message waiting: Frequency Shift Keying (FSK) and Stutter Dial Tone (SDT). The default is SDT. If your voice mail provider uses FSK to signal a waiting message, follow the steps below to deactivate the SDT feature on your phone:

- 1) Press **MENU** soft key. Select the Global Setup menu, and then the Voice Mail Tone Submenu.
- 2) Press **volume up/down** to select L1 or L2, and then press the **OK** soft key.
- 3) Press **volume up/down** to turn the voice message indication (SDT message signal) on or off.
- 4) Press the **OK** soft key. You will hear a confirmation tone.



Resetting the New Message LED and Envelope icon

If the LED remains on or the envelope icon still appears after you've retrieved your messages, you may need to reset the indicators. With the phone is in standby mode, press and hold **flash/find handset** on the base until the paging sound stops (about 5 seconds).

Find Handset

To locate the handset, press **flash/find handset** on the base when the phone is in standby mode. All registered handsets beep for 60 seconds, and **Paging** appears on the handset display. To cancel paging, press any key on the handset or **flash/find handset** on the base.

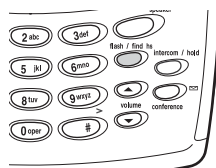

If the battery pack is completely drained, the handset will not beep.

Setting up the Phonebook

You can store names and numbers in your phone's phonebook, search for names alphabetically, and dial phonebook entries with just a few key presses. Phonebook memory is stored independently in the base and the cordless handsets. You can store up to 100 numbers in the base and up to 100 numbers in each handset.

The phone uses the same memory locations to store phonebook entries and Caller ID messages. Any empty phonebook locations are used to store Caller ID messages. For example, if you have stored 100 phonebook entries on your base unit, the base will not store Caller ID messages.

Storing and Editing Phone Numbers, Names, Distinctive Rings and Speed Dial

1) When the phone is in standby mode, press *phonebook*.

The following items appear:

(1st line) <Phonebook> title

(2nd line) The number of the phonebook locations used

(3rd line) How to search (press the number keypad, *volume up/down*)

(4th line) The **COPY**, **STORE**, and **DELETE** soft keys.



2) Press the **STORE** soft key. Store/Edit Name appears.



3) Enter the name (up to 16 characters) by using the number keypad. If a name is not required, go to step 4. <No Name> will be used as the name. Refer to the letters on the number keys to select the desired characters. With each press of a number key (**0-9**), the displayed character appears in the following order: Upper case letters first, lower case letters next and finally the number corresponding to the key.

keys	Number of times key is pressed								
	1	2	3	4	5	6	7	8	9
1	1								
2 abc	A	B	C	a	b	c	2		
3 def	D	E	F	d	e	f	3		
4 ghi	G	H	I	g	h	i	4		
5 jkl	J	K	L	j	k	l	5		
6 mno	M	N	O	m	n	o	6		
7 pqrs	P	Q	R	S	p	q	r	s	7
8 tuv	T	U	V	t	u	v	8		
9 wxyz	W	X	Y	Z	w	x	y	z	9
0 oper	0	<	>	<	>	/	(blank)
	#	@							*

For example, to enter Movies:

- 1) Press 6 once, and then press #/> to move the cursor to the right.
- 2) Press 6 six times.
- 3) Press 8 six times.
- 4) Press 4 six times.
- 5) Press 3 five times.
- 6) Press 7 eight times.

If you make a mistake while entering a name

Use */tone/< or #/> to move the cursor to the incorrect character.

Press the **DELETE** soft key to erase the wrong character, and then enter the correct character. To delete all characters press and hold the **DELETE** soft key.



- Selecting a Phonebook location where a number is already stored overwrites the old number. The new number will be stored in the Phonebook location.
- When the memory is full, you will hear a beep and **Memory Full** appears. You cannot store names and numbers.
- The pause key counts as one digit. Pressing **vol/√/redial/p** (**redial/pause** on the base) more than once increases the length of the pause between numbers. Each pause represents a 2 second delay.

- 4) Press the **OK** soft key to store the name; Store/Edit No. appears.



- 5) Use the number keypad, ***/tone/<**, or ***/>** to enter the phone number (up to 20 digits).

If you make an error, use the **DELETE** soft key to erase the incorrect digits. When you are finished, press the **OK** soft key to store the number.

- 6) If you store the phonebook location from the handset, **Distinctive Ring** appears. Press **volume up/down** to move the pointer to one of the Distinctive Ring options and then press the **OK** soft key.

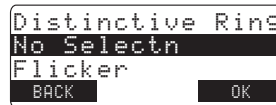

If you choose not to store a Distinctive Ring, simply select the "No Selectn" option.

- 7) **Speed Dial** appears. Press **volume up/down** to move the pointer to select the Speed dial location (10 locations: SPD1-SPD0).

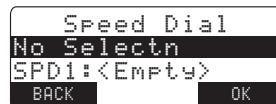

If you choose not to store the name/number as a Speed Dial, simply choose the "No Selectn" option.

- 8) Press the **OK** soft key. You will hear a confirmation tone, and **Done!** appears in the display.



Storing Caller ID messages in the Phonebook

Messages shown in the Caller ID list can be stored in the phonebook (see page 51). The phone number and name of the party on the Caller ID list can be stored in memory.

- 1) When the phone is in standby mode, select the Caller ID message to be stored.
- 2) Press the **EDIT** soft key. Press *volume up/down* to select Store into PB?, and then press the **OK** soft key.
- 3) Store/Edit Name appears.
If the Caller ID message is already stored in memory, you will hear a beep and This data is already stored!! appears. The number will not be stored.
- 4) To complete the setting, follow the steps 4-8 in “Storing and Editing Phone Numbers, Names, Distinctive Rings and Speed Dial” on page 41.

Storing a Redial Record

- 1) With the phone in standby mode, press *redial/p* (or *redial/pause* on the base) in standby mode.
- 2) Press *volume up/down* repeatedly to display the number to be stored.
- 3) Press the **EDIT** soft key.
- 4) Press *volume up/down* to choose Store into PB?, and then press the **OK** soft key.
- 5) To complete the setting, follow the steps 3-8 in “Storing and Editing Phone Numbers, Names, Distinctive Rings and Speed Dial” on page 41.

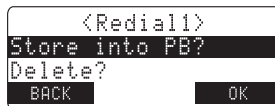

- If a call comes in via a telephone system that does not offer Caller ID service, no information is stored.
- If the Caller ID message was received as a private/unknown number, or the message does not have the number, you cannot store the message in the Phonebook. If it was received as private/unknown name, the message will be stored as <No Name>.
- Even if all 100 memory locations are full, the message will be stored in the Phonebook. However, the message will be erased from the Caller ID list.

Viewing the Phonebook

- 1) Press **phonebook**.
- 2) Press **volume up/down** to scroll through the phonebook locations. Phonebook locations appear in alphabetical order (from first to last when you press **volume down**, from last to first when you press **volume up**).



You can also use the letters on the number keys to select the first letter of the desired name. Press a number key (**2-9** and **0**) once for the first letter, twice for the second letter, and so on. The first location that begins with the letter you entered appears.

For example, to search for an entry beginning with the letter M, press **6** once. Press **volume up/down**, until the phonebook location is displayed.

- 3) To finish the viewing operation:

From the Handset-press **end** (or the **BACK** soft key during a call).

From the Base-press **exit** key (or the **BACK** soft key during a call).

Making Calls Using the Phonebook

1) View the phonebook location to dial (see "Viewing the Phonebook" on page 45).



2) When the phone is in standby mode, press **talk/flash** or **speaker** on the handset (or **speaker** on the base). The phone will automatically select a free line. To select a particular line, press the **LINE1** or **LINE2** soft key. The displayed number is dialed.

When the phone is in talk mode, press the **DIAL** soft key to dial the number.

3) To hang up press **end** on the handset (or **speaker** on the base).

Speed Dialing

You can program up to ten speed dial numbers in the base and up to ten speed dial numbers in each handset. You must program a speed dial number before you can use the speed dialing feature. When the phone is in standby mode, press and hold a number key (**0-9**) associated with the speed dial until the phone number appears, and then press **talk/flash** or **speaker** on the handset or **speaker** on the base. The phone will automatically select a free line. To select a particular line, press the **LINE1** or **LINE2** soft key. The number stored in the speed dial (SPD1 - SPD0) is dialed.

note

To have the phone select Line 1 or Line 2 instead of a free line, set the default telephone line (see page 19).

Editing or Erasing a Stored Name, Phone Number, Distinctive Ring and Speed Dial

- 1) When the phone is in standby mode, press **phonebook**.

To delete all phonebook locations, press the **DELETE** soft key. `Delete All?` appears. Use **volume up/down** to select `Yes`, and then press the **OK** soft key. You will hear a confirmation tone.



A screenshot of a phone's phonebook menu. The text on the screen is: <Phonebook>, Total: 5, Search [A-Z/↑/↓]. At the bottom, there are three soft key options: COPY, STORE, and DELETE.

- 2) Use **volume up/down** or the number keypad to select desired phonebook entry (see "Viewing the Phonebook" on page 45).
- 3) When you have found the desired phonebook entry, press the **EDIT** soft key.
- 4) To edit the entry, use **volume up/down** to select `Edit?`. To delete the entry, select `Delete?`. Then press the **OK** soft key.
- 5) If you are deleting the entry, you will hear a confirmation tone, and `Deleted!` appears in the display.



A screenshot of a phone's 'Store/Edit Name' menu. The text on the screen is: Store/Edit Name, Movies. At the bottom, there are three soft key options: BACK, DELETE, and OK.

If you are editing the entry, follow the steps 3 to 8 under "Phonebook (Storing Phone Numbers, Names, Distinctive Rings, and Speed Dial)" on page 41 to complete the editing operation.

Copying Phonebook Locations

Copy Phonebook allows you to transfer stored phonebook locations from handset to handset or from base to handset (or from handset to base) without having to manually re-enter names and numbers. You can transfer one memory (phonebook location) at a time, or all memory locations at once.

- 1) When the phone is in standby mode, press **phonebook**.
- 2) Press the **COPY** soft key.
- 3) Press **volume up/down** to select the handset or base to which you want transfer the phonebook locations and then press the **OK** soft key.
- 4) Press **volume up/down** to select One Memory or All Memories: and then press the **OK** soft key.

If you select All Memory, Are you sure? appears on the display screen.

Press **volume up/down** to select Yes, and then press the **OK** soft key.

If you select One Memory, press **volume up/down**, or the number key (**2-9** and **0**) to select the phonebook location you want to export and then press the **COPY** soft key.

- 5) The phonebook locations will be transferred to the handset or the base. Copying and the receiving handset name or base appear. When the transfer is completed Done! appears on the handset or the base.

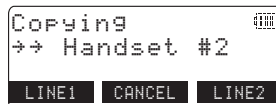
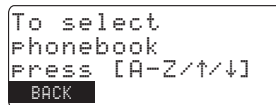
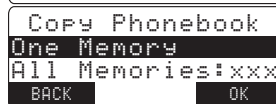
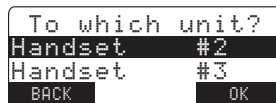

- Even if all 100 memory locations are full, the message will be stored in the Phonebook. However, the oldest Caller ID message will be erased from the Caller ID list.
- If you stored 100 phonebook locations, you can not store the phonebook locations and Not enough memory in receiving unit appears.
- If the selected handset is party is in out of range or data transfer is canceled, Unavailable appears in the display. Phonebook locations will not be transferred.



- If you answer a call before the Caller ID message is received, the Caller ID message will not appear.
- When the call is received via a telephone company that does not offer Caller ID service, the caller's phone number and name does not appear. (This includes some international calls.)
- When the call is via a private branch exchange (PBX), the caller's phone number and name may not appear.

Caller ID and CIDCW (Caller ID on Call Waiting)

You must subscribe to Caller ID services through your local telephone provider to use these features.

When the telephone rings, the Caller ID feature allows you to view the caller's name, phone number, date and time of call. With CIDCW (Caller ID on Call Waiting), you will hear a call waiting tone while you are on a call, and the Caller ID data is displayed. To accept the waiting call, press **talk/flash** on the handset or **flash/find hs** on the base. Additionally, you can dial a number stored in the Caller ID list or save data to your Phonebook locations.

Important:

Memory locations for Caller ID messages and Phonebook locations (including Speed Dials) are common, you can store up to all 100 locations for each handset and the base. A Caller ID message is not stored when you have stored 100 of the phonebook locations. When you have stored all 100 of the phonebook locations and Caller ID messages in total, the earliest Caller ID message is overwritten.

The date and time received	12/21 12:30P * [1]
Caller's name	Uniden Corp
Caller's phone number	817-858-3300
	LINE1 EDIT LINE2

When the Caller ID message is received, the display shows the caller's phone number along with the date and time. The incoming call information is stored in the Caller ID record. If the Caller ID service includes the caller's name, the name will appear in the display (up to 15 characters).

You may receive any one of the following messages:

When a private name is received; Private Name

When a private number is received; Private Number

When a unknown name is received; Unknown Name

When a unknown number is received; Unknown Number

When invalid data is received; Incomplete Data



Data errors appear as "■."

Call Waiting Deluxe Features

Your phone gives you new options for call waiting. At the touch of a button, you can place the caller on hold, send them to your voice mail service, or conference them into your current call. You must subscribe to Call Waiting and Call Waiting Deluxe to use these features. Not all features are available in all areas. Check with your local telephone company for details.

- 1) When you receive a Call Waiting call, press the **MENU** soft key, and select **CallWaitDeluxe** for a list of options.
- 2) Press **volume up/down** or the number keypad (**1-7**) to select an option.

Ask to Hold - A prerecorded message states that user will be available shortly, and the call is placed on hold.

Tell Busy - A prerecorded message tells the caller you are busy, and the waiting call is disconnected.

Forward Call - The caller is sent to your voice mail box, if available.



•To activate CWDX features, select **CW On/CWDX On** in the CIDCW option. See page 27.

•If you don't press a key within 30 seconds while in the operation, the phone back to a call. To return back to a call, press the **BACK** soft key.



• Check with your local telephone company for a full list of options.

• * icon appears next to the line icon to indicate this is a unread message. Once you view the new message, the * icon will disappear.

Answer/Drop 1 - Disconnects the first call, and connects to the new caller.

Conference - Starts a conference call with your first and second callers.

Drop First/Drop Last - During a conference call, allows you to choose to drop the first or last caller.

- 3) Press the **OK** soft key. A confirmation screen will appear, and the phone returns to the call.

Viewing the Caller ID List

The Caller ID list stores information for incoming calls - even unanswered calls. You can store up to 100 Caller ID messages and Phonebook locations (including Speed Dials) for each handset and the base. You can view the Caller ID list through the handset or base.

- 1) When the phone is in standby mode, press **cid/volume up** (or **cid** on the base).

For handset, when the phone is in talk mode, press the **MENU** soft key, then select the Caller ID menu.

The summary screen appears. The screen shows the number of new messages and total messages.

- 2) To view the Caller ID messages in historical order (newest to oldest or from oldest to newest), use **volume down** to scroll through the messages from the latest to the earliest, or **volume up** to scroll back through the messages.

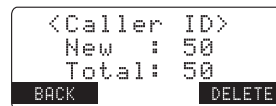

To view the Caller ID messages with alphabetical search, press the number key pad (**2-9** and **0**) with the letter associated with the first letter of the desired message.



Once you view the Caller ID list with alphabetical search, you cannot switch back to historical order unless you exit and re-enter the operation.

3) To finish the viewing operation:

From Handset - press **end** or the **BACK** soft key during a call.

From Base - press **exit** or the **BACK** soft key during a call.

Deleting Information from the Caller ID List

1) When the phone is in standby mode, view the Caller ID information to be deleted (see "Viewing the Caller ID List" on page 51).

2) Press the **EDIT** soft key.

3) Press **cid/volume up** to select **Delete?**, and then press the **OK** soft key.

4) Press **redial/p/volume down** to select **Yes**, and then press the **OK** soft key.

5) You will hear a confirmation tone.



Deleting all Caller ID names/numbers

1) When the phone is in standby mode, press **vol/^/cid** on the handset (or **cid** on the base).

2) Press the **DELETE** soft key. **Delete All?** appears.

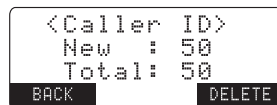

Once the Caller ID data has been deleted, the information cannot be retrieved



- When a long distance call has been set, "1" appears in the display.
- You cannot make a call from the Caller ID list if your phone is connected to a private branch exchange (PBX).

- 3) Press **volume up/down** to choose Yes.
- 4) Press the **OK** soft key. You will hear a confirmation tone.



Calling a Party from the Caller ID List

- 1) Select the Caller ID message (see "Viewing the Caller ID List" on page 51).



To have the phone dial a "1" before the displayed Caller ID number, press ***/tone/**<. To have the phone dial the stored area code before the displayed Caller ID number, press **#/**>.

- 2) When the phone is in standby mode, press **talk/flash** or **speaker** on the handset or **speaker** on the base. The phone will automatically select a free line. To select a particular line, press the **LINE1** or **LINE2** soft key. The displayed phone number dials automatically. When the phone is in talk mode, press the **DIAL** soft key.

Multi-Handset Features

The features in this section require a minimum of two handsets to operate. To add additional handsets to your system, see "Expanding Your Phone" on page 13.

Using the DirectLink Mode

In DirectLink Mode, a pair of handsets can function as two-way radios. You can have up to five pairs of handsets in DirectLink Mode at a time. DirectLink Mode does not interfere with the main base's ability to make or receive telephone calls. Use them at sporting events or while shopping to stay in contact with family members or friends. You must set both handsets to DirectLink Mode to activate this feature.

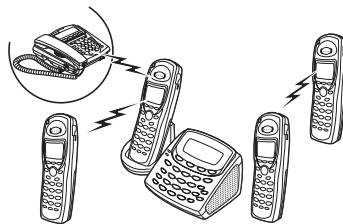

- 1) Press the **MENU** soft key and select DirectLink Mode menu. To enter DirectLink mode Press [ENTER] appears.
- 2) Press the **ENTER** soft key to enter DirectLink mode. You will hear a confirmation tone, and DirectLink Mode Complete appears.
- 3) To return to normal standby mode, press the **CANCEL** soft key and then the **OK** soft key, or return the handset to the cradle.

```
To enter
DirectLink mode
Press [ENTER]
BACK      ENTER
```

note

Handsets can be in Direct Link mode while other handsets are in use.

DirectLink call

- 1) When the phone is in DirectLink standby mode, press the **DirectLink** soft key (example of DirectLink from handset #1).
- 2) Select the handset to which you wish to DirectLink with by pressing the number keys (**0-9**). Your handset will then page the other handset.
- 3) On the receiving handset, press **talk/flash**, the **ANSWER** soft key, or if Any Key Answer is on, press any number key, ***/tone/<**, or ***/>**.
- 4) When you finish your conversation, press **end** or the **END** soft key on either handset. Return the handset to the cradle, or press the **CANCEL** soft key and then the **OK** soft key to return to normal standby mode (canceling DirectLink mode).

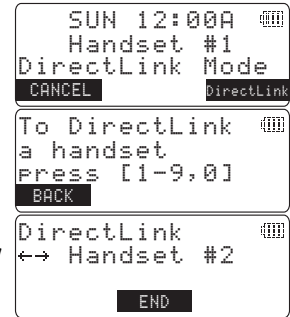

Intercom

The intercom feature lets you communicate with another handset or the base without using the phone line.

Making an Intercom Page

From a handset

- 1) With the phone in standby mode, press **intcom/hold**.
- 2) Use **vol/▲/cid** or **vol/▼/redial/p** to select the base or the handset you want to talk with, and then press the **OK** soft key. If you select **A11**, all other handsets and the base will be paged. An intercom tone sounds. To cancel intercom, press **end** or the **CANCEL** soft key.



From the base

- 1) With the phone in standby mode, press **intercom/hold** on the base.
- 2) Use **volume/▲** or **volume/▼** to select the handset you want to talk with, and then press the **OK** soft key. If you select **A11**, all other handsets will be paged. An intercom tone sounds. To cancel intercom, press **intercom/hold** or the **CANCEL** soft key.

Answering an Intercom Page

When the intercom page tone sounds, the display will show the ID of the handset or base that is paging.

note

- If the party is busy, the handset returns to standby mode.
- If the party is out of range, "Unavailable" appears in the display, and the operation will be canceled.
- If you receive an outside/intercom call or page while selecting the other handset (or the base), the operation will be canceled.
- If you do not select a handset or the base within thirty seconds, the operation will be canceled.
- If the party does not answer within one minute, the operation is canceled.



- If all handsets and the base are paged, only the first party to answer the page will connect.
- If you do not select a handset or the base within ten seconds, the operation will be canceled.

From a handset

- 1) Pick up the handset from the cradle. (If AutoTalk is enabled, the handset will automatically answer when you pick it up. Or if Any Key Answer is enabled, pressing a number key, **/tone/<*, or *#/>* will answer the page.)
- 2) Press *talk/flash*, *intcom/hold*, or the **ANSWER** soft key.

From the base

To answer with the base speakerphone, press *intercom/hold*, *speaker*, or the **ANSWER** soft key.

To hang up an intercom page, press the **END** soft key, or press *end* on the handset or *Intercom/hold* on the base, or return the handset to the cradle.

Call Transfer Feature

The call transfer feature allows you to transfer a call between the base and a handset or between two handsets.

From a handset

- 1) During a call, press *intcom/hold* on the handset.
The line soft key (**LINE1** or **LINE2**) to be placed on hold will flash. The Call will be put on hold.
- 2) Use press *vol/∧/cid* or *vol/∨/redial/p* to select the base or the handset you want to transfer the call to, then press the **OK** soft key. If you select **ALL**, all other handsets and the base will be paged.
The call will automatically be placed on hold, and a paging tone sounds.

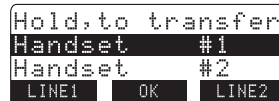

To cancel the transfer, press **talk/flash**, the **CANCEL** soft key or **speaker** on the initiating handset.

From the base

- 1) During a call, press **intercom/hold** on the base. The line soft key (**LINE1** or **LINE2**) to be placed on hold will flash. The Call will be put on hold.
- 2) Use **volume/▲** or **volume/▼** to select the handset you want to transfer the call to, and then press the **OK** soft key. If you select **A11**, all handsets will be paged. A paging tone sounds.

To cancel the transfer, press **intercom/hold**, **speaker** or the **CANCEL** soft key on the base.

Answering a Call Transfer Page

When the page tone sounds, the display will show the ID of the handset or base that is transferring the call.

To answer a page from a handset

- 1) Pick up the handset from the cradle. (If AutoTalk is enabled, the handset will automatically answers when you pick it up. Or if Any Key Answer is enabled, pressing a number key, ***/tone/<**, or ***/>** will answer the page.)
- 2) Press **talk/flash**, **intcom/hold**, or the **ANSWER** soft key.

To answer a page from the base

To answer with the base speakerphone, press **intcom/hold**, **speaker**, or the **Answer** soft key.

Accepting the call transfer

After answering the page, if you want to accept the call and speak to the outside caller, press the corresponding soft key (**LINE1** or **LINE2**).



- This feature only works when both handsets are within the range of the base.
- If the party is out of range, *Unavailable* appears in the display, and the operation will be canceled.

Room/Baby Monitor

This feature allows you to monitor sounds in another room. Place the base or a handset in the room you wish to monitor; it will function as a microphone. A second handset can be set to function as a remote speaker, allowing you to monitor sounds in the room.

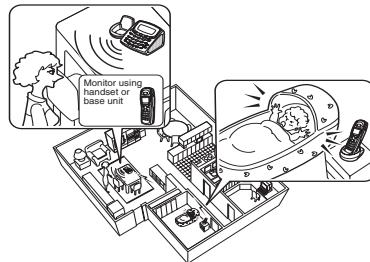

Using Room/Baby Monitor

- 1) Press the **MENU** soft key and select Room Monitor menu. *Listen to:* appears.
- 2) Select the handset or base you want to monitor by using **volume up/down**.
- 3) Press the **OK** soft key. *Monitoring* appears, and you hear sounds in the room where the handset or the base is installed.
- 4) To turn off the Room Monitor, press the **END** soft key, or **end**.



To prevent the monitoring of a particular handset or the base, simply turn off the Room Monitor feature on that handset or on the base.

- 1) Press the **MENU** soft key. Select the Handset Setup menu, and then the Room Monitor submenu.
- 2) Press **volume up/down** to select *Off*.
- 3) Press the **OK** soft key. You will hear a confirmation tone.



Note on Power Sources

Power Failure

During the period that the power is off, you will not be able to make or receive calls with the telephone.

Battery replacement and handling

When the operating time becomes short, even after a battery is recharged, please replace the battery. With normal usage, your battery should last about one year. Please contact your place of purchase or the Uniden Parts Department for a replacement battery.

Warning

To avoid the risk of personal injury or property damage from fire or electrical shock, only use the Uniden battery model and Uniden adapter model specifically designated for this product.

Caution

- Use only the specified Uniden battery pack (BT-446).
- Do not remove the batteries from the handset to charge them.
- Never throw the battery into a fire, disassemble them, or heat them.
- Do not remove or damage the battery casing.



Even when the battery pack is not being used, it will gradually discharge over a long period of time. For optimum performance, be sure to return the handset to the base unit after each telephone call.

Low battery alert

When the battery pack is very low, the phone is programmed to eliminate functions in order to save power.

The battery pack needs to be charged when:

- The empty battery icon appears.
- Low Battery appears in the display.

If the phone is in standby mode, none of keys will operate. If you are on a call, complete your conversation as quickly as possible, and return the handset to the cradle.

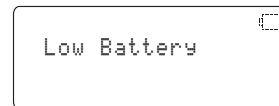

Cleaning the battery charging contacts

To maintain a good charge, clean the charging contacts on the handset once a month. Dampen a cloth with plain water. Gently rub the damp cloth over the charging contacts until all visible dirt is removed. Dry the contacts thoroughly before returning the handset to the base.

Caution: Do not use paint thinner, benzene, alcohol, or other chemical products. Doing so may discolor the surface of the telephone and damage the finish.



General Information

The phone complies with FCC Parts 15 and 68. Operating temperature:
0 °C to +50 °C (+32 °F to +122 °F)

AC Adapter Information

AC Adapter part number: AD-0006 for the base
Input Voltage: 120 AC 60Hz
Output Voltage: 9V DC 500mA

Battery Information

Battery part number: BT-446
Capacity: 800mAh, 3.6V



- To avoid damage to the phone use only Uniden AD-0006 and BT-446 with your phone.
- If the handset is left off of the base, the actual Talk mode duration will be reduced respective to the amount of time the handset is off the base.

Recharge your phone on a regular basis by returning the handset to the base after each phone call. When the operating time becomes short even after the battery is recharged, please replace the battery. With normal usage, the battery should last about one year.

A replacement Uniden adapter or battery may be purchased by contacting the Uniden Parts Department (800) 554-3988. Hours are from 8:00 a.m. to 5:00 p.m. Central Time, Monday through Friday, or **www.uniden.com**.

Specifications, features, and availability of optional accessories are all subject to change without prior notice.

Troubleshooting

If your phone is not performing to your expectations, please try these simple steps first.

Symptom	Suggestion
The charge LED won't illuminate when the handset is placed in the cradle.	<ul style="list-style-type: none">• Make sure the AC adapter is plugged into the base or the charger (if you have more than one handset) and wall outlet.• Make sure the handset is properly seated in the cradle.• Make sure the charging contacts on the handset are clean.
The audio sounds weak.	<ul style="list-style-type: none">• Move the handset and/or base away from metal objects or appliances and try again.• Make sure that you are not too far from the base.
Can't make or receive calls.	<ul style="list-style-type: none">• Make sure that you are not too far from the base.• Make sure the line is not in use. If an out call is already using a line, you cannot use that line to make another outside call.• Check both ends of the base telephone line cord.• Make sure the AC adapter is plugged into the base and wall outlet.• Disconnect the AC adapter for a few minutes, and then reconnect it.• De-register the handset (see "De-register the Handset (Handset only)" on page 15) and register the handset (see "Register the Handset" on page 14).
The handset doesn't ring or receive a page.	<ul style="list-style-type: none">• Make sure that you are not too far from the base.• Charge the batteries in the handset for 15-20 hours by placing the handset on the base or charging cradle.• De-register the handset (see "De-register the Handset (Handset only)" on page 15) and register the handset (see "Register the Handset" on page 14).
Severe noise interference.	<ul style="list-style-type: none">• Keep the handset away from microwave ovens, computers, remote control toys, wireless microphones, alarm systems, intercoms, room monitors, fluorescent lights, and electrical appliances.• Move to another location or turn off the source of interference.

Symptom	Suggestion
The Caller ID does not display.	<ul style="list-style-type: none"> • The handset was picked up before the second ring. • The call was placed through a switchboard. • Call your local telephone company to verify your Caller ID service is current. There may be a problem with your Caller ID service.
You cannot register the handset at the base.	<ul style="list-style-type: none"> • Charge the battery pack for 15-20 hours. • De-register the handset (see “De-register the Handset (Handset only)” on page 15) and register the handset (see “Register the Handset” on page 14).
The handset doesn't communicate with other handsets.	<ul style="list-style-type: none"> • De-register the handset (see “De-register the Handset (Handset only)” on page 15) and register the handset (see “Register the Handset” on page 14). • Make sure that you have registered all handsets.
An extra handset can't join the conversation.	<ul style="list-style-type: none"> • Make sure there are not 2 handsets already using the conference feature. • Make sure that another handset or base is not in privacy mode.
The base can't join the conversation	<ul style="list-style-type: none"> • Make sure that another handset or base is not in privacy mode.
Room Monitor feature does not work.	<ul style="list-style-type: none"> • Make sure both handsets (or the handset and the base) are set to Room Monitor mode and that both are turned on. • Make sure to place the handset(s) within the range of the base.

Liquid Damage

Moisture and liquid can damage your cordless phone. In case of accidental submersion, please read the following steps.

Case	Action
If the handset or base is exposed to moisture or liquid, but only affects the exterior plastic housing.	Wipe off the liquid, and use as normal.
If moisture or liquid has entered the plastic-housing (i.e. liquid can be heard in the phone or liquid has entered the handset battery compartment or vent openings on the base).	<p>Handset:</p> <ol style="list-style-type: none">1)Remove the battery cover and leave it off for ventilation.2)Remove the battery pack by disconnecting.3)Leave the battery cover off and the battery pack disconnected for at least 3 days.4)Once the handset is completely dry, reconnect the battery pack and the battery cover.5)Recharge the handset's battery pack for 20 hours before using again. <p>Base:</p> <ol style="list-style-type: none">1)Disconnect the AC adapter from the base unit, cutting off electrical power.2)Disconnect the telephone cord from the base unit.3)Let dry for at least 3 days. <p>IMPORTANT: You must unplug the telephone line while recharging the battery packs to avoid charge interruption.</p> <p>CAUTION: DO NOT use a microwave oven to speed up the drying process. This will cause permanent damage to the handset, base and the microwave oven.</p> <p>After following these steps, if your cordless telephone does not work, please send to:</p> <p style="text-align: center;">Uniden America Corporation Parts and Service Division 4700 Amon Carter Blvd. Ft. Worth TX 76155 1-800-554-3988. Monday through Friday 8 a.m. to 5 p.m. CST</p>

Precautions!

Before you read anything else, please observe the following:

Warning!

Uniden America Corporation DOES NOT represent this unit to be waterproof. To reduce the risk of fire, electrical shock, or damage to the unit, DO NOT expose this unit to rain or moisture.

Rechargeable Nickel-Metal-Hydride Battery Warning

- This equipment contains a rechargeable Nickel-Metal-Hydride battery.
- Nickel is a chemical known to state of California to cause cancer.
- The rechargeable Nickel-Metal-Hydride battery contained in this equipment may explode if disposed of in a fire.
- Do not short-circuit the battery.
- Do not charge the rechargeable Nickel-Metal-Hydride battery used in this equipment in any charger other than the one designed to charge this battery as specified in the owner's manual. Using another charger may damage the battery or cause the battery to explode.

Rechargeable Nickel-Metal-Hydride Batteries Must Be Recycled or Disposed of Properly

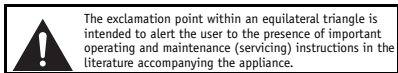

The exclamation point within an equilateral triangle is intended to alert the user to the presence of important operating and maintenance (servicing) instructions in the literature accompanying the appliance.

Uniden works to reduce lead content in our PVC coated cords in our products and accessories.

Warning!

The cords on this product and/or accessories contain lead, a chemical known to the State of California to cause birth defects or other reproductive harm. **Wash hands after handling.**

Important Safety Instructions

When using your telephone equipment, basic safety precautions should always be followed to reduce the risk of fire, electric shock and injury to persons, including the following:

1. Do not use this product near water, for example, near a bath tub, wash bowl, kitchen sink or laundry tub, in a wet basement or near a swimming pool.
2. Avoid using a telephone (other than a cordless type) during an electrical storm. There may be a remote risk of electric shock from lightning.
3. Do not use the telephone to report a gas leak in the vicinity of the leak.

4. Use only the power cord and batteries indicated in this manual. Do not dispose of batteries in a fire. They may explode. Check with local codes for possible battery disposal instructions.
5. Do not disassemble any component of this product.

SAVE THESE INSTRUCTIONS

CAUTION

Risk of explosion if battery is replaced by an incorrect type. Dispose of used batteries according to the instructions. Do not open or mutilate the battery, and disconnect the battery before shipping this product.

The FCC Wants You To Know

This equipment complies with Part 68 of the FCC rules and the requirements adopted by the ACTA. On the bottom of this equipment is a label that contains, among other information, a product identifier in the format US:AAAEQ##TXXXX. If requested, this number must be provided to the telephone company.

An applicable Universal Service Order Codes (USOC) certification for the jacks used in this equipment is provided (i.e., RJ11C) in the packaging with each piece of approved terminal equipment.

A plug and jack used to connect this equipment to the premises wiring and telephone network must comply with the applicable FCC Part 68 rules and requirements adopted by the ACTA. A compliant telephone cord and modular plug is provided with this product. It is designed to be connected to a compatible modular jack that is also compliant. See installation instructions for details.

The REN is used to determine the number of devices that may be connected to a telephone line. Excessive RENs on a telephone line may result in the devices not ringing in response to an incoming call. In most but not all areas, the sum of RENs should not exceed five (5.0). To be certain of the number of devices that may be connected to a line, as determined by the total RENs, contact the local telephone company. For products approved after July 23, 2001, the REN for this product is part of the product identifier that has the format US:AAAEQ##TXXXX. The digits represented by ## are the REN without a decimal point (e.g., 03 is a REN of 0.3). For earlier products, the REN is separately shown on the label.

If this equipment causes harm to the telephone network, the telephone company will notify you in advance that temporary discontinuance of service may be required. But if advance notice isn't practical, the telephone company will notify the customer as soon as possible. Also, you will be advised of your right to file a complaint with the FCC if you believe it is necessary.

The telephone company may make changes in its facilities, equipment, operations or procedures that could affect the operation of the equipment. If this happens the telephone company will provide advance notice in order for you to make necessary modifications to maintain uninterrupted service. Please follow instructions for repairing, if any (e.g. battery replacement section); otherwise do not substitute or repair any parts of the device except as specified in this manual.

Connection to party line service is subject to state tariffs. Contact the state public utility commission, public service commission or corporation commission for information. This equipment is hearing aid compatible.

Should you experience trouble with this equipment, please contact Uniden customer service at 800-297-1023. If the equipment is causing harm to the telephone network, the telephone company may request that you disconnect the equipment until the problem is resolved.

NOTICE: According to telephone company reports, AC electrical surges, typically resulting from lightning strikes, are very destructive to telephone equipment connected to AC power sources. To minimize damage from these types of surges, a surge arrester is recommended.

Changes or modifications to this product not expressly approved by Uniden, or operation of this product in any way other than as detailed by the owner's manual, could void your authority to operate this product.

This device complies with part 15 of the FCC rules. Operation is subject to the following two conditions: (1) This device may not cause harmful interference, and (2) This device must accept any interference received, including interference that may cause undesired operation. Privacy of communications, may not be ensured when using this phone.

To insure the safety of users, the FCC has established criteria for the amount of radio frequency energy various products may produce depending on their intended usage. This product has been tested and found to comply with the FCC's exposure criteria. For body worn operation, the FCC RF exposure guidelines were also met when used with the Uniden accessories supplied or designed for this product. Use of other accessories may not ensure compliance with FCC RF exposure guidelines and should be avoided.

Radio Interference

Radio interference may occasionally cause buzzing and humming in your cordless handset, or clicking noises in the base. This interference is caused by external sources such as TV, refrigerator, vacuum cleaner, fluorescent lighting, or electrical storm. Your unit is NOT DEFECTIVE. If these noises continue and are too distracting, please check around your home to see what appliances may be causing the problem. In addition, we recommend that the base not be plugged into a circuit that also powers a major appliance because of the potential for interference. Be certain that the antenna on the unit is fully extended when needed. In the unlikely event that you consistently hear other voices or distracting transmissions on your phone, you may be receiving radio signals from another cordless telephone or other source of interference. If you cannot eliminate this type of interference, you need to change to a different channel.

Finally, it should be noted that some cordless telephones operate at frequencies that may cause interference to nearby TVs and VCRs. To minimize or prevent such interference, the base of the cordless telephone should not be placed near or on top of a TV or VCR. If interference is experienced, moving the cordless telephone farther away from the TV or VCR will often reduce or eliminate the interference.

Cordless Telephone Privacy

Cordless telephones are radio devices. Communications between the handset and base of your cordless telephone are accomplished by means of radio waves which are broadcast over the open airways. Because of the inherent physical properties of radio waves, your communications can be received by radio receiving devices other than your own cordless telephone unit. Consequently, any communications using your cordless telephone may not be private.

One Year Limited Warranty

Important: Evidence of original purchase is required for warranty service. **WARRANTOR: UNIDEN AMERICA CORPORATION ("Uniden") ELEMENTS OF WARRANTY:** Uniden warrants, for one year, to the original retail owner, this Uniden Product to be free from defects in materials and craftsmanship with only the limitations or exclusions set out below.

WARRANTY DURATION: This warranty to the original user shall terminate and be of no further effect 12 months after the date of original retail sale. The warranty is invalid if the Product is (A) damaged or not maintained as reasonable or necessary, (B) modified, altered, or used as part of any conversion kits, subassemblies, or any configurations not sold by Uniden, (C) improperly installed, (D) serviced or repaired by someone other than an authorized Uniden service center for a defect or malfunction covered by this warranty, (E) used in any conjunction with equipment or parts or as part of any system not manufactured by Uniden, or (F) installed or programmed by anyone other than as detailed by the owner's manual for this product.

STATEMENT OF REMEDY: In the event that the product does not conform to this warranty at any time while this warranty is in effect, warrantor will either, at its option, repair or replace the defective unit and return it to you without charge for parts, service, or any other cost (except shipping and handling) incurred by warrantor or its representatives in connection with the performance of this warranty. Warrantor, at its option, may replace the unit with a new or refurbished unit. **THE LIMITED WARRANTY SET FORTH ABOVE IS THE SOLE AND ENTIRE WARRANTY PERTAINING TO THE PRODUCT AND IS IN LIEU OF AND EXCLUDES ALL OTHER WARRANTIES OF ANY NATURE WHATSOEVER, WHETHER EXPRESS, IMPLIED OR ARISING BY OPERATION OF LAW, INCLUDING, BUT NOT LIMITED TO ANY IMPLIED WARRANTIES OF MERCHANTABILITY OR FITNESS FOR A PARTICULAR PURPOSE. THIS WARRANTY DOES NOT COVER OR PROVIDE FOR THE REIMBURSEMENT OR PAYMENT OF INCIDENTAL OR CONSEQUENTIAL DAMAGES.** Some states do not allow this exclusion or limitation of incidental or consequential damages so the above limitation or exclusion may not apply to you.

LEGAL REMEDIES: This warranty gives you specific legal rights, and you may also have other rights which vary from state to state. This warranty is void outside the United States of America and Canada.

PROCEDURE FOR OBTAINING PERFORMANCE OF WARRANTY: If, after following the instructions in the owner's manual you are certain that the Product is defective, pack the Product carefully (preferably in its original packaging). Disconnect the battery from the Product and separately secure the battery in its own separate packaging within the shipping carton. The Product should include all parts and accessories originally packaged with the Product. Include evidence of original purchase and a

note describing the defect that has caused you to return it. The Product should be shipped freight prepaid, by traceable means, to warrantor at:

Uniden America Service
4700 Amon Carter Blvd.
Fort Worth, TX 76155

I.C. Notice

TERMINAL EQUIPMENT

NOTICE: This equipment meets the applicable Industry Canada Terminal Equipment Technical Specifications. This is confirmed by the registration number. The abbreviation, IC, before the registration number signifies that registration was performed based on a Declaration of Conformity indicating that Industry Canada technical specifications were met. It does not imply that Industry Canada approved the equipment.

NOTICE: The Ringer Equivalence Number (REN) for this terminal equipment is marked on the equipment itself. The REN assigned to each terminal equipment provides an indication of the maximum number of terminals allowed to be connected to a telephone interface. The termination on an interface may consist of any combination of devices subject only to the requirement that the sum of the Ringer Equivalence Numbers of all the devices does not exceed five.

RADIO EQUIPMENT

The term "IC:" before the radio certification number only signifies that Industry Canada technical specifications were met.

Operation is subject to the following two conditions: (1) this device may not cause interference, and (2) this device must accept any interference, including interference that may cause undesired operation of the device. "Privacy of communications may not be ensured when using this telephone".

Index

0-9

20 ring options 20

A

Animation screen 24

Anykey Answer 22

Area Code 27

AutoTalk 21

B

Banner 22

Battery

 Preparing and charging 9

 Replacement and handling 60

Beltclip 16

C

Call transfer feature 57

Caller ID

 Call Waiting 31

 Caller ID services 49

 Calling 53

 CIDCW 49

 CWDX 50

 Deleting 52

 Setting 27

 Storing 44

 Viewing 51

Clock 26

Conferencing 36

Contrast 23

Copying phonebook 48

D

Deluxe Call Waiting Features 50

De-register the handset 15

Dial mode 28

Digital security code 14

DirectLink 54

Distinctive ringer 21

E, F, G, H

Earpiece volume 33

Expanding your phone 13

General information 62

Hands-free conversation 30

Headset installation 16

Hold 32

I, J, K, L

I.C. notice 68

Important safety instructions 66

Intercom 56

Key touch tone 24

Language 23

Liquid damage 65

M, N, O

Making a call 29

Mute 34

P, Q

Phonebook

 Editing 47

 Erasing 47

 Making calls 46

 Storing 41

 Viewing 45

Precautions 66

Privacy Mode 36

R

Receiving a call 29

Redialing 32

Redialing a call 32

Register the handset 14

Ringer

 Adjusting 19

 Do not disturb 34

 mute 34

Room/baby monitor 59

 Setting 59

 Using 59

S

Set TEL-LINE 19

Setting up

 base unit 10, 19

 Handset 9, 19

 Menu options 18

 Telephone Line 10, 19

Soft Key 7

Speed dialing 46

T, U, V, W, X, Y, Z

Transferring a call 57

Troubleshooting 63

Voice Mail Access 38

Voice Mail Tone 39

Warranty 67

Main Menu Flow Chart

- From standby mode
- Base



MENU →



- Handset



MENU →



∨



∨



∨

↓ OK

↓ OK

↓ OK

↓ OK



↓ Enter

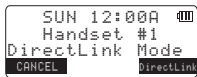

∧

or

∨

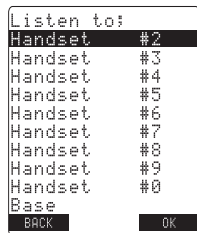

∧

or

∨

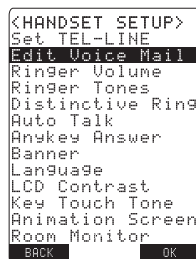

▲

or

▼

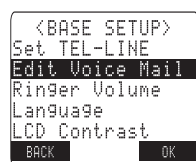

•Base



•Handset

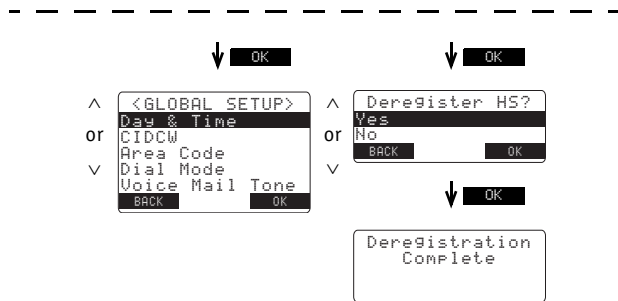

Memory List

	Name	Phone No.		Name	Phone No.		Name	Phone No.
1			35			69		
2			36			70		
3			37			71		
4			38			72		
5			39			73		
6			40			74		
7			41			75		
8			42			76		
9			43			77		
10			44			78		
11			45			79		
12			46			80		
13			47			81		
14			48			82		
15			49			83		
16			50			84		
17			51			85		
18			52			86		
19			53			87		
20			54			88		
21			55			89		
22			56			90		
23			57			91		
24			58			92		
25			59			93		
26			60			94		
27			61			95		
28			62			96		
29			63			97		
30			64			98		
31			65			99		
32			66			100		
33			67					
34			68					

Memo

At Uniden, we'll take care of you!

Thank you for purchasing a Uniden product. If you have any questions or problems,
please do not return this product to the place of purchase.



Having Trouble?

Our customer care specialists are here to help you! Visit our website at www.uniden.com or call our Customer Service Hotline at **1-800-297-1023**, Mon-Fri, 7 a.m. to 7 p.m. or Sat/Sun, 9 a.m. to 5 p.m. CST. (The Customer Service Hotline is closed on holidays.)



Need a Part?

To order headsets, additional handsets, replacement batteries or other accessories, visit our website at www.uniden.com or call 1-800-554-3988, Mon-Fri, 8 a.m. to 5 p.m. CST.



Help for our Special Needs Customers

If you need special assistance due to a disability or have questions on the accessibility features of this product, please call **1-800-874-9314 (voice or TTY)**

Uniden®

May be covered under one or more of the following U.S. patents:

4,797,916	5,381,460	5,426,690	5,434,905	5,491,745	5,493,605
5,533,010	5,574,727	5,581,598	5,650,790	5,660,269	5,661,780
5,663,981	5,671,248	5,696,471	5,717,312	5,732,355	5,754,407
5,758,289	5,768,345	5,787,356	5,794,152	5,801,466	5,825,161
5,864,619	5,893,034	5,912,968	5,915,227	5,929,598	5,930,720
5,960,358	5,987,330	6,044,281	6,070,082	6,125,277	6,253,088
6,314,278	6,418,209	6,618,015	6,671,315	6,714,630	6,782,098
6,788,920	6,788,953	6,839,550	6,889,184	6,901,271	6,907,094
6,914,940					

Other patents pending.

FOR
ACCESSORIES,
GO ONLINE @
WWW.UNIDEN.COM

REGISTER ONLINE TODAY!

THANK YOU FOR BUYING A UNIDEN PRODUCT.

A World Without Wires | **Uniden®**