

tru24.¹GHZ
DIGITAL SPREAD SPECTRUM

OWNER'S MANUAL

Uniden[®]

TRU246





CONTENTS

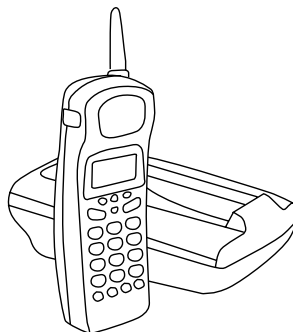

Introduction / Features	inside front cover
Controls and Functions	.2,3
Getting Started	
Read this first	4
Step 1: Checking the package contents	5
Step 2: Setting up the base unit	6
Mounting the base unit on a wall	9
Step 3: Preparing the battery pack	11
Adjusting the ringer and earpiece volume	13
Basics	
Making a call	14
Receiving a call	16
Redialing a call	17
Traveling out-of-range	18
Telephone Features	
Memory dialing	
Storing phone numbers and names	19
Making calls with memory dialing	21
Chain dialing	22
Editing a stored name and/or phone number	23
Erasing a stored name and phone number	25
Paging	26
Caller ID Features	
Caller ID	27
When the telephone rings	29
Viewing the Caller ID Message list	30
Deleting information from the Caller ID list	31
Using the Caller ID list	33
Using "Caller ID on call waiting" service	35
Call Waiting features	36
Additional Information	
Changing the digital security code	37
Beltclip installation	38
Headset installation	38
Note on power sources	39
Maintenance	39
Troubleshooting	40
Index	42

INTRODUCTION

Congratulations on your purchase of the TRU 246 cordless telephone. This phone is designed for reliability, long life, and outstanding performance utilizing the latest in 2.4 GHz Spread Spectrum technology.

Note: Some illustrations in this manual may differ from the actual unit for explanation purposes.

FEATURES

- 2.4 GHz Spread Spectrum Technology
- Caller ID and Call Waiting Caller ID
- 50 Number Caller ID Memory
- Advanced Caller ID with Call Waiting Option
- Lighted Keypad
- 3-Line, 16 Character Backlit Handset Display
- 20 Enhanced Memory Dial Locations
- 32 Digit Redial
- 3 Redial Memories
- Flash
- Pause
- Pulse/Tone Dialing
- Page/Find
- 10 Day Standby Battery Life
- 6 Hour Talk Time
- Handset Earpiece and Ringer Volume Control
- Hearing Aid Compatible

Digital Spread Spectrum Technology utilizes a “wider frequency band” vs. a “single narrow band” used in standard digital transmissions. The 2.4 GHz frequency range was recently released to commercial communications. The result is a more secure conversation with the clarity of digital sound, extended range, and minimal interference from other cordless phones.

Random Code™ digital security automatically selects one of approx. 65,000 codes for the handset and base.

These features enhance your phone’s security and also prevent unauthorized calls as a result of your phone being activated by other equipment.

CONTROLS AND FUNCTIONS

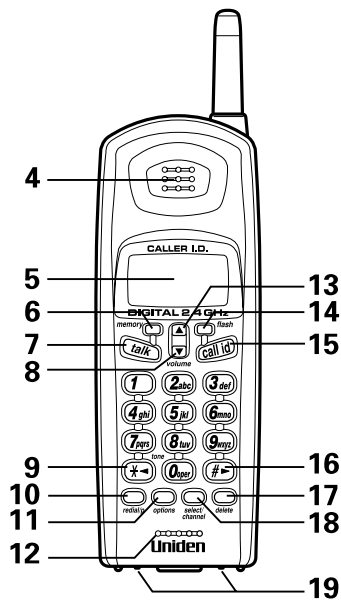
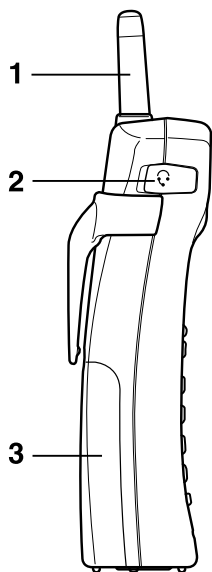

1. Handset antenna
2. Headset jack cover
3. Handset battery compartment
4. Handset earpiece
5. LCD display
6. Memory key
7. Talk key
8. Volume/Cursor down key
9. * /tone key
10. Redial/Pause key
11. Options key
12. Handset microphone
13. Volume/Cursor up key
14. Flash key
15. Call ID key
16. # key
17. Delete key
18. Select/Channel key
19. Handset charging contacts

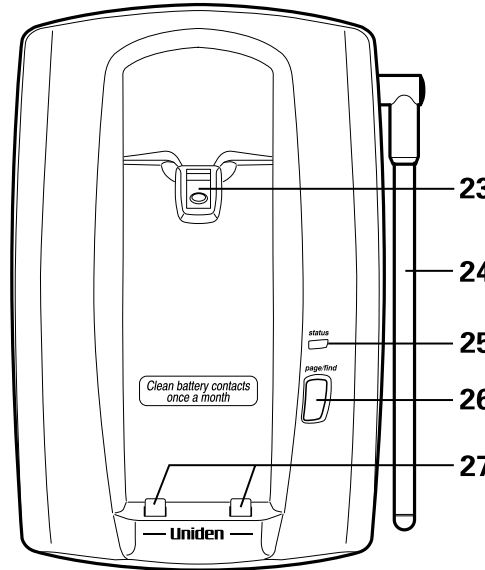
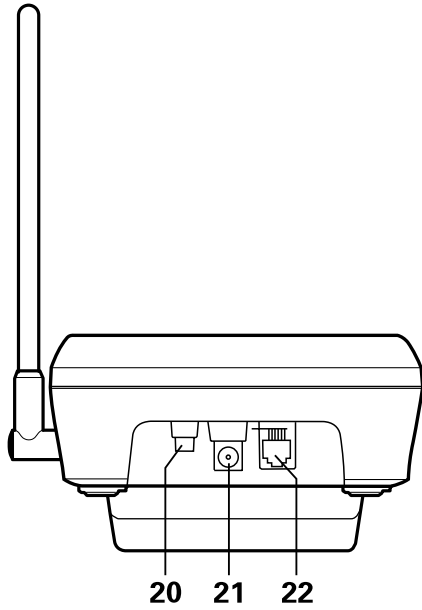

- 20. Pulse-Tone switch
- 21. DC power input
- 22. Phone jack
- 23. Handset retainer clip
- 24. Base antenna
- 25. Status LED
- 26. Page/Find key
- 27. Base charging contacts

READ THIS FIRST

This cordless telephone must be set up before use. Follow these steps;

Step 1 (page 5)

Unpack and check the telephone and accessories.

Step 2 (page 6 to 10)

Next, choose the best location to set up the base unit.



Base unit

Step 3 (page 11 to 12)

Then, insert the battery pack into the handset. You must charge the battery pack for 15 hours before using the phone.



Handset

About the digital security code

This cordless telephone uses a digital security code to prevent unauthorized access to your base unit. This security code prevents other cordless handsets from making calls through your base unit. A random security code will be assigned automatically between your base unit and handset when you charge the battery pack for the first time.

If you want to reset the security code, see page 37.

CHECKING THE PACKAGE CONTENTS

Make sure you have received the following items in the package.

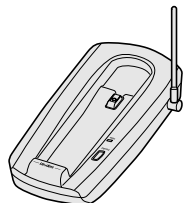

• Base unit



• Handset

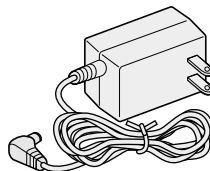

• AC adapter (AD-311)

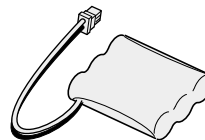

• Rechargeable
battery pack
(BT-905)

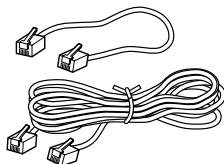

• Telephone line
cord (2)

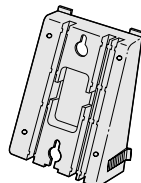

• Wall mount
adapter



• Beltclip

- This Owner's Manual
- Precautions and Important Safety Instructions
- Quick Reference Guide
- Registration Card

Uniden Parts Department

(800) 554-3988

Hours: M-F 7:00 AM to 5:00 PM CST.

We can also be reached on the web at www.uniden.com.

SETTING UP THE BASE UNIT

Do the following steps.

- Choose the best location
- Connect the base unit
- Choose the dialing mode

Choose the best location

Before choosing a location for your new phone, read the **INSTALLATION CONSIDERATIONS** included in the **PRECAUTIONS AND IMPORTANT SAFETY INSTRUCTIONS** brochure. Here are some important guidelines you should consider:

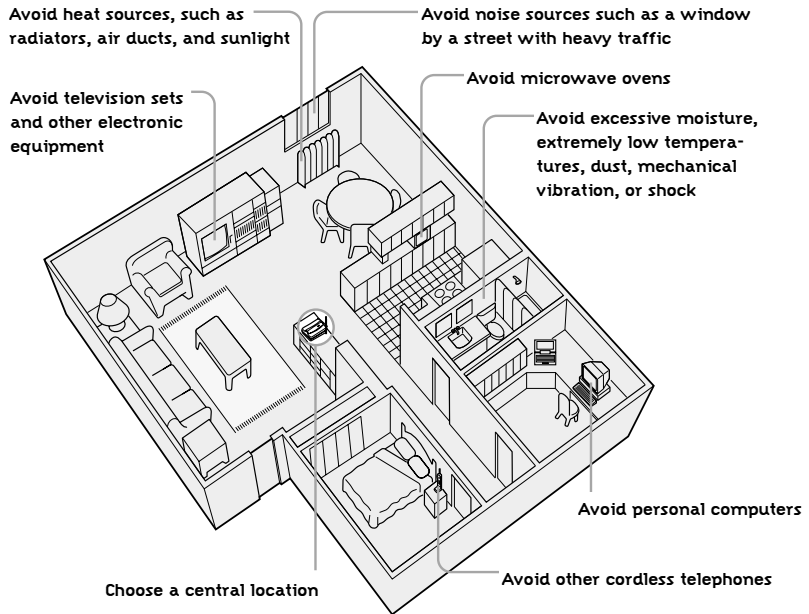

- You should charge your handset at least 15 hours before using the phone.
- The location should be close to both a phone jack and a continuous power outlet which is not switchable.
- Keep the base and handset away from sources of electrical noise such as motors and fluorescent lighting.
- Be sure there is sufficient space to raise the base antenna to a vertical position.
- The base can be placed on a desk, tabletop or mounted on a standard wall plate.

Connect the base unit

If you want to install the base unit on the wall, see page 9

- 1 Connect the telephone line cord to the **TEL LINE** jack and to a telephone outlet.
- 2 Connect the AC adapter to the **DC IN 9V** jack and to a standard 120V AC wall outlet.
- 3 Set the base unit on a desk or tabletop and place the handset on the base unit. Then raise the antenna to a vertical position.

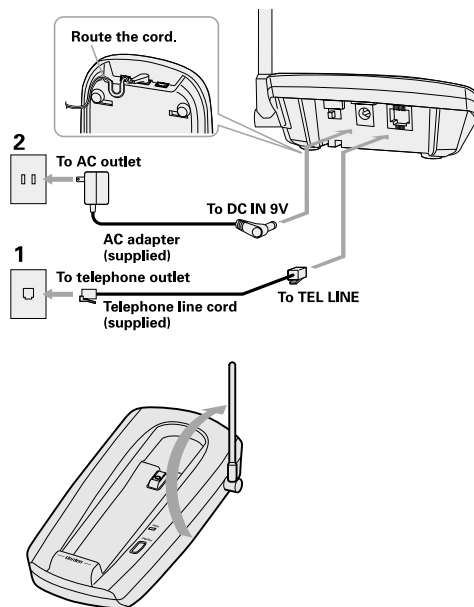

Place the power cord so it does not create a trip hazard or where it could become chafed and create a fire or electrical hazard.



Use only the supplied AD-311 AC adapter. Do not use any other AC adapter.



Connect the AC adapter to a continuous power supply.



Place the base unit close to the AC outlet so that you can unplug the AC adapter easily.



If your telephone outlet isn't modular, contact your telephone company for assistance.



Modular

Choose the dialing mode

Depending on your dialing system, set the **PULSE-TONE** switch as follows:

If your dialing system is	Set the switch to
Tone	<i>TONE</i>
Pulse	<i>PULSE</i>

If you aren't sure of your dialing system

Make a trial call with the **PULSE-TONE** switch set to ***TONE***.

If the call connects, leave the switch as is; otherwise, set to ***PULSE***.

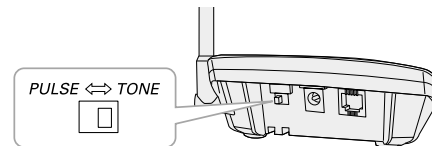

MOUNTING THE BASE UNIT ON A WALL

Standard wall plate mounting

This phone can be mounted on any standard telephone wall plate.

- 1 Snap the wall mount adapter into the notches on the base.
- 2 Plug the telephone line cord to the **TEL LINE** jack and the AC adapter to the **DC IN 9V** jack.
- 3 Plug the telephone line cord into the telephone outlet.
- 4 Wrap the AC adapter cord inside the molded wiring channel. Then wrap the cord around the strain relief notch.
- 5 Plug the AC adapter into a standard 120V AC wall outlet.
- 6 Raise the antenna to a vertical position.
- 7 Align the mounting slots on the base with the mounting posts on the wall. Push in and down until the phone is firmly seated.
- 8 On the base unit, pull the handset retainer out of the slot. Rotate it clockwise 180 degrees.
- 9 Flip the retainer from front to back. Slide it back into the slot so that the lip of the retainer is up and the oval is down. The retainer holds the handset in place.

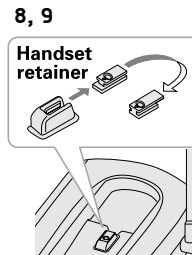
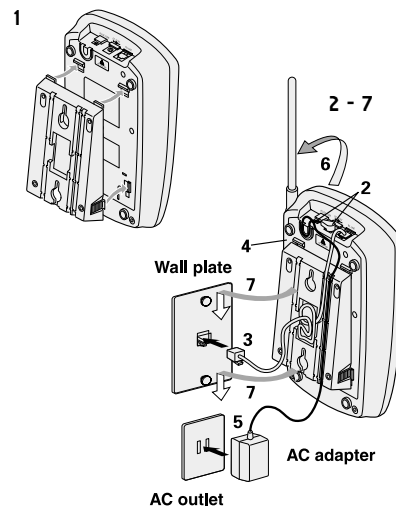

If you have wall mounted the base, you cannot place the handset with the keypad facing inside. (See page 38.)

Direct wall plate mounting

If you don't have a standard wall plate, you can mount your phone directly to the wall. Before doing this, consider the following:

- Avoid electrical cables, pipes, or other items behind the mounting location that could cause a hazard when inserting screws into the wall.
- Try to mount your phone within 10 - 15 feet of a working phone jack to avoid excessive cord lengths.
- Make sure the wall material is capable of supporting the weight of the base and handset.
- Use #10 screws (minimum length of 1-3/8 inches) with anchoring devices suitable for the wall material where the base unit will be placed.

- 1 Insert two mounting screws into the wall, (with their appropriate anchoring device), 3-15/16 inches apart. Allow about 3/16 of an inch between the wall and screwheads for mounting the phone.
- 2 Refer to steps 1 through 9 on page 9 to mount the telephone.

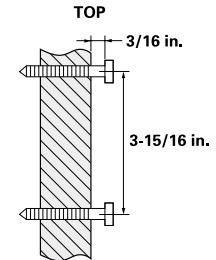

PREPARING THE BATTERY PACK

Charge the battery pack for at least 15 hours before you start using your phone.

- 1 Press in on the battery cover release and slide the cover down until it comes off.
- 2 Connect the battery pack connector with the correct polarity (black and red wires), then insert the battery pack into the battery compartment.
- 3 Securely close the battery compartment cover by sliding it up until it snaps into place.
- 4 Place the handset on the base.
- 5 Make sure that the *status* LED lights. If the LED doesn't light, check to see that the AC adapter is plugged in and that the handset makes good contact with the base charging contacts.



Use only the Uniden Battery (BT-905) supplied with your phone.

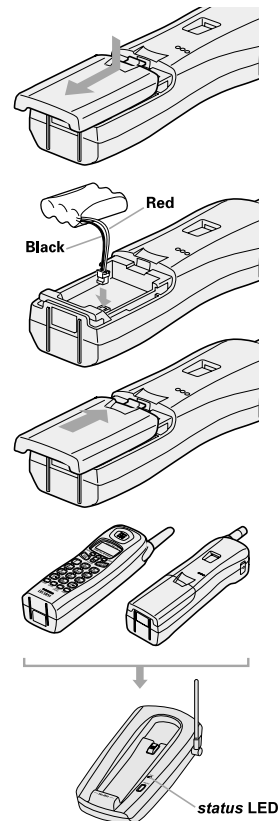



Even when the battery pack is not being used, it will gradually discharge over a long period of time.

For optimum performance, be sure to return the handset to the base unit after a telephone call for charging the battery.

Battery use time (per charge)

From fully charged

- Six hours continuous use.
- Ten days when the handset is in the standby mode.

When the battery charge becomes low

When the battery pack is very low and needs to be charged, the phone is programmed to eliminate functions in order to save power. If the phone is not in use, "Low Battery" flashes and none of the keys will operate. If the phone is in use, "Low Battery" flashes and the handset beeps. Complete your conversation as quickly as possible and return the handset to the base unit for charging.

Cleaning the battery contacts

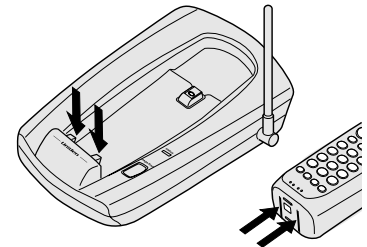
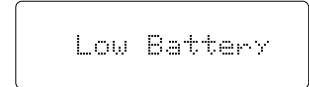

To maintain a good charge, it is important to clean the battery contacts on the handset and base unit with a dry cloth or a pencil eraser about once a month.

Do not use any liquids or solvents.











ADJUSTING THE RINGER AND EARPIECE VOLUME



Ringer tone and volume

The phone has four types of ringer tone and volume combinations.
In the standby mode, press  or  on the handset repeatedly.
The display shows the setting.

Earpiece volume

Pressing  or  during a call will change the earpiece volume of the handset. This setting will remain in effect after the telephone call has ended.

<Loud>   <High>   <Medium>   <Normal>

When you press  in Loud mode or press  in Normal mode, the error tone sounds.



- Press **delete** if you enter a wrong number in step 1.
- You must press a key within 20 seconds or the phone will return to standby.

MAKING A CALL

Dialing from standby

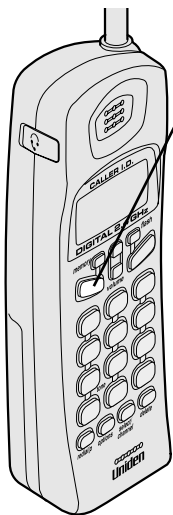

- 1 Enter the phone number. (Up to 32 digits.)
Example: Enter 8178583300

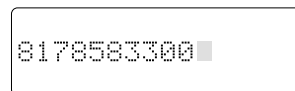

- 2 Press **talk**. "Talk" flashes on the display. Then the volume setting is displayed.



Example: Volume level High

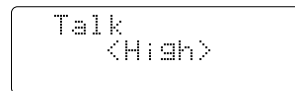

- 3 The number is dialed. After about 5 seconds, the call-time display appears.

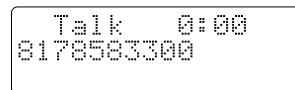

- 4 To hang up, press **talk** or place the handset on the base. The call-time will be displayed for about 5 seconds.

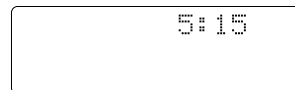

Other Operations

To	Do this
To adjust the earpiece volume	Press ▲ or ▼ during a call.
To temporarily switch to tone dial (When the base is set to pulse mode)	Press (*)tone(→) . The following numbers will be sent as tone dialing.
To enter a pause within dialing sequence	Press (redial/p) .
To improve the reception	Press (select/channel) during a call. "Scanning" appears on the display. If the operation fails, the error tone sounds.

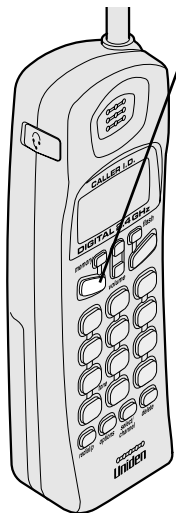

Dialing from talk mode

- 1 Press **(talk)**. "Talk" flashes on the display. Then the volume setting is displayed.

Example: Volume level High

⤴ Talk ⤵

Talk
<High>

- 2 Dial the phone number.
Example: Enter 8178583300

Talk 0:17
8178583300

- 3 To hang up, press **(talk)** or place the handset on the base. The call-time will be displayed for about 5 seconds.

10:03

RECEIVING A CALL

From the handset

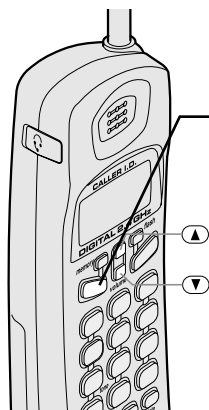

1 The phone rings.

2 Press **talk**. "Talk" and volume setting appear on the display.

3 Talk with the caller.

4 To hang up, press **talk** or place the handset on the base. The call time will be displayed for about 5 seconds.

Incoming Call

Talk 0:00
<Normal>

Talk 0:02

1:15:35

AutoTalk when ringing

When the AutoTalk setting is on and there is an incoming call, simply lift the handset from the base unit to answer the phone. See "Setting Caller ID options" on page 27 for more details.

Any key answer when ringing

When the AutoTalk setting is on and the handset is off the base, press any handset key to answer the incoming call.

Call Waiting

Note: You must subscribe to Call Waiting service to use this feature.

When a call is received during a telephone call already in progress, press **flash** to switch to the new call. If you also subscribe to Call Waiting on Caller ID, you will see the name and number of the caller in call waiting. (See page 35.)

REDIALING A CALL

The last three phone numbers dialed can be quickly redialed.

Redial from standby

- 1 Press **redial/p** .
The phone number that was last dialed appears on the display.
- 2 Press **redial/p** again.
Each press of **redial/p** will display one of the last three numbers dialed.

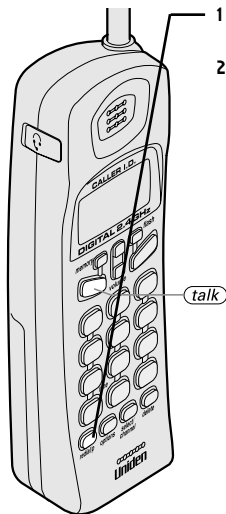

Most
recent

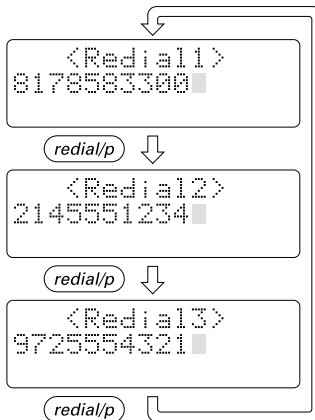

- 3 Press **talk** . The number will be dialed.



If the number exceeds 32 digits, only the first 32 digits are retained for redialing.

Redial from talk mode

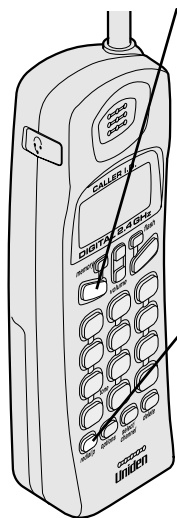

- 1 Press **(talk)** .
"Talk" and the volume setting appear on the display.

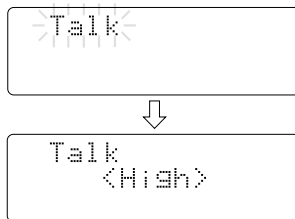

- 2 Press **(redial/p)** .
The last number dialed will be displayed and redialed.

- 3 To hang up, press **(talk)** or place the handset on the base. The call-time will be displayed for about 5 seconds.



Only the last number dialed can be accessed after **(talk)** has been pressed.

TRAVELING OUT-OF-RANGE

During a call, as you begin to move your handset too far from your base unit, noise increases. If you pass the range limits of the base unit, your call will terminate within 30 seconds.

STORING PHONE NUMBERS AND NAMES

Memory Dialing allows you to dial a number using just a few key strokes. You can store up to 20 phone numbers in the memory.

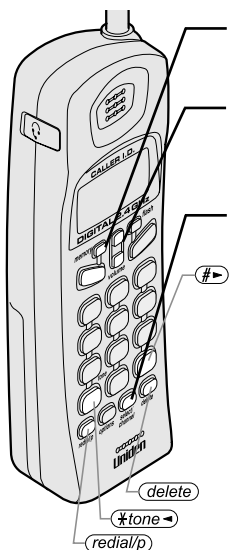

- 1 Press and hold **memory** until "Memory Store" is displayed.
- 2 Press **▲** and **▼** or enter a two-digit number (01 - 20) to select the memory location where you would like to store the number.
- 3 Press **select/channel** .
The following screen appears and a cursor flashes indicating that the display is ready for the name to be entered.
If this screen appears, the selected memory location is already stored. Then, you must either change the entry in this location, clear the location, or select "Go Back" to choose another location.
- 4 Use **▲** , **▼** , or **delete** to enter the name. The name cannot exceed 13 characters.
 - Use **▲** and **▼** to scroll through the character menu. It contains upper and lower case letters and various characters.
 - Use **#▶** and ***tone→** to move the cursor to the desired location.
 - Use **delete** to delete characters as needed.

```
Memory Store
01▶
02
```

```
Store Name
█
```

```
#Edit Memory07
Delete Memory07
Go Back
```



In memory dialing operation, you must press a key within 20 seconds or the phone will return to standby. If you return the handset to the base, the phone will also return to standby.

5 Press *(select/channel)* .

“Store Number” is displayed. The cursor flashes indicating that the display is ready for the number to be entered.

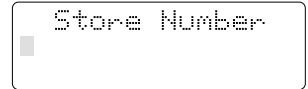

Store Number
█

6 Use the number keypad to enter the phone number.

The phone number cannot exceed 20 digits.

- Use *(redial/p)* to enter a pause in the dialing sequence. The display shows a “P”.

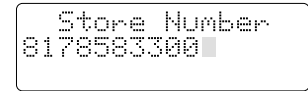

Store Number
0178583300█



The pause feature is useful for long distance calling, credit card dialing, or sequences that require a pause between digits.

- Use *(delete)* to delete digits as needed.

7 Press *(select/channel)* .

The handset beeps and displays the confirmation screen. Memory storage is complete.

For example, if you store a name and number into memory location number 07, the display shows “Memory07 Stored”.

After about 2 seconds, “Memory Store” is displayed.

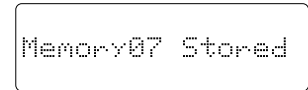

Memory07 Stored



Memory Store
07 UNIDEN CORP
08

8 Press *(memory)* to return to standby mode.

MAKING CALLS WITH MEMORY DIALING

Memory dialing from standby

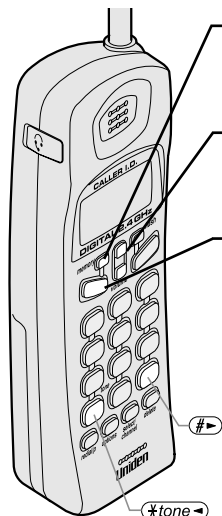

- 1 Press **(memory)**.
The handset displays your programmed memory locations.
- 2 Press **(▲)** and **(▼)** or enter a two-digit number (01 - 20) to select the memory location you would like to dial.
- 3 Press **(talk)**. "Talk" and the volume setting appear on the display. Then the displayed number is dialed.

```

01 UNIDEN CORP
02 JOHN DOE
03▶MOM AND DAD
    
```

```

-Talk-
0123456789012
    
```

Display a Programmed Number

Use **(#▶)** and **(*tone▶)** to toggle between the names display and the numbers display.

Program name		Program number
01 UNIDEN CORP	→▶	01 8178583300
02 JOHN DOE		02 5452930
03▶MOM AND DAD	←▶	03▶8175551212



When the stored phone number has 14 or more digits, "▶" is displayed next to the 12th digit. Press **(#▶)** to see the extra digits and **(*tone▶)** to return.

```

05 012345678901
06▶011813554329▶
07
    
```



- If you press **(select/channel)** before **(talk)**, you can confirm the name and number stored in the selected memory location.
- To exit the memory function without dialing, press **(memory)**. The handset returns to standby.

Memory dialing from talk mode

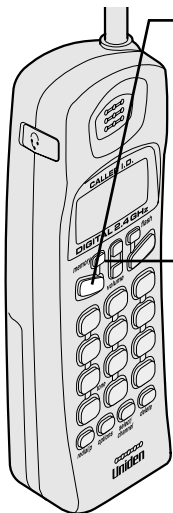

1 Press **talk** .
“Talk” and the volume setting appear on the display.

2 Press **memory** .

3 Enter a two-digit number (01 - 20) to select the memory location of the desired phone number.
The selected phone number is displayed.
Then the number is dialed.

Talk



Talk
<High>

Talk 0:00

Talk 0:35
0123456789012

CHAIN DIALING

On certain occasions after dialing a number, you may be requested to enter an access code, such as your account number. You can enter this number into a memory location for later use by doing the following:

- 1) Store the access code into one of the memory locations (01-20) following the steps on page 19.
- 2) Dial the party or service main number.
- 3) When you need to enter the special number, press **memory** followed by the memory location (01-20).

EDITING A STORED NAME AND/OR PHONE NUMBER

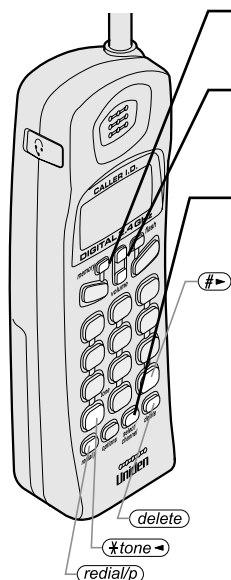

- 1 Press and hold memory until "Memory Store" is displayed.
- 2 Press ▲ and ▼ or enter a two-digit number (01 - 20) to select the memory location you would like to edit.
- 3 Press select/channel .
The following screen appears with the memory location number that you have selected in the display.
- 4 Press ▲ or ▼ to select "Edit Memory", then press select/channel. The following screen appears.
The cursor flashes indicating that the display is ready for the name to be edited. When a name has not been stored, the cursor appears at the beginning of the second line.
- 5 Press ▲ , ▼ , # , *tone , or delete to edit the name. (See page 19.)
To edit only the phone number, skip this step.
- 6 Press select/channel .
The following screen appears.
The cursor flashes indicating that the display is ready for the number to be edited.

```
Memory Store
01 UNIDEN CORP
02 JOHN DOE
```

```
► Edit Memory01
Delete Memory01
Go Back
```

```
Store Name
UNIDEN CORP █
```

```
Store Number
017058330 █
```

7 Use the number keypad, **(redial/p)** or **(delete)** to edit the phone number.
 The phone number cannot exceed 20 digits.
 (See page 20.)
 If you don't want to change the phone number, skip this step.

8 Press **(select/channel)**. The handset beeps and displays the confirmation screen. The memory storage is complete.
 For example, if you store a name and number into memory location number 01, the display shows "Memory01 stored".
 After about 2 seconds, "Memory Store" is displayed.

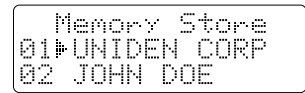
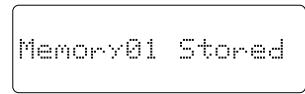

9 Press **(memory)** to return to standby mode.

Display a Programmed Number

Use **(#>)** and **(*tone<)** to toggle between the names display and the numbers display.

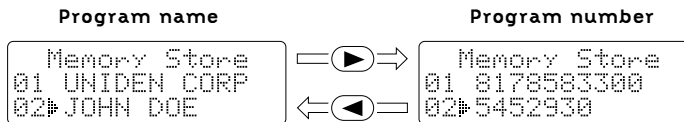

- When the stored phone number has 14 or more digits, "→" is displayed next to the 12th digit.
 Press **(#>)** to see the extra digits and **(*tone<)** to return.

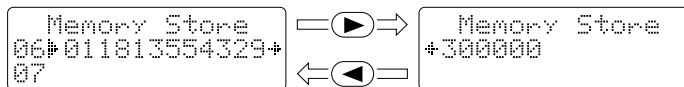

ERASING A STORED NAME AND PHONE NUMBER

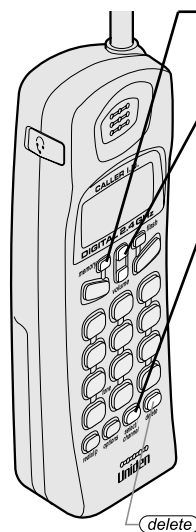

- 1 Press and hold **(memory)** until "Memory Store" is displayed.
- 2 Press **(▲)** and **(▼)** or enter a two-digit number (01 - 20) to select the memory location you would like to edit.
- 3 Press **(select/channel)** .
The following screen appears with the memory location number that you have selected in the display.
- 4 Press **(▼)** to move the cursor down to the "Delete Memory" command line.
- 5 Press **(select/channel)** . The following confirmation screen appears.
- 6 Press **(▲)** to move the cursor to "Yes".
- 7 Press **(select/channel)** or **(delete)** .
There is a confirmation tone and the entry is deleted. The following screen appears.
- 8 After a few seconds the display returns to the "Memory Store" screen.
You may select another number to delete (return to step 2) or press **(memory)** to return to standby.

```
Memory Store
01▶UNIDEN CORP
02 JOHN DOE
```

```
▶Edit Memory02
Delete Memory02
Go Back
```

```
Edit Memory02
▶Delete Memory02
Go Back
```

```
Delete Memory02?
Yes
▶No
```

```
Memory02 Deleted
```

```
Memory Store
02▶
03 MOM AND DAD
```



By holding **page/find** for more than 2 seconds, the handset beeps for 60 seconds.

PAGING

To locate the handset

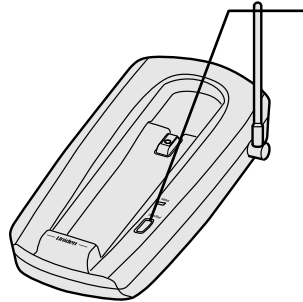

- 1 Press **page/find** on the base.
- 2 The handset beeps for 5 seconds.
The following screen appears;

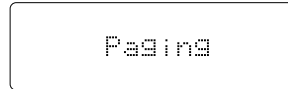

- 3 Press any key on the handset to end.



When an incoming call is received during paging, paging is canceled and the telephone is switched to the incoming call.



If you press **talk** during paging, the handset will be placed in off-hook (talk) mode.

CALLER ID

You must subscribe to Caller ID service to use this feature.

When the telephone rings, the Caller ID feature allows you to view the caller's name and phone number on the display before you answer the phone.

The handset displays the phone number of the incoming call, the name, time, and the number of calls. Additionally, you can dial the displayed number and store the information for memory dialing.

Setting Caller ID options

There are three Caller ID setup options available; they are AutoTalk, CIDCW (Caller ID on Call Waiting), and Area Code.

AutoTalk allows you to answer the phone without pressing **talk**. If the phone rings when AutoTalk is on, simply remove the handset from the base and the phone automatically answers the call. Or, if the handset is not on the base, press any key to answer the call. If the phone rings when AutoTalk is off, you must press **talk** to answer the call.

Caller ID on Call Waiting (CIDCW) performs the same as regular Caller ID on a call waiting number. Call Waiting options allow you to handle call waiting calls in seven different ways. (See page 36.)

If you enter a 3-digit area code number in the **Area Code** option, your local area code does not appear in Caller ID messages. When reviewing Caller ID messages, you will see only the local seven digit number. For calls received from outside your local area code, you will see a full 10-digit number.



If your calling area requires 10-digit dialing, do not program this option.



You must subscribe to Caller ID on Call Waiting in order to use this feature.

To change your Caller ID options:

- 1 Press *(options)* . The following screen appears.
- 2 Use *(▲)* , *(▼)* , or a number key (1-3) to move the pointer to the selection that you would like to change.
Press *(select/channel)* to toggle between “On” and “Off” for “Auto Talk”. For “CIDCW”, choose “On”, “Off”, or “Offt”, depending upon the type of service to which you subscribe.
- 3 When you wish to enter Area Code, press *(▼)* or the number key *(3)* to move the cursor to select “Area Code”. Then press *(select/channel)* and enter the 3 digits area code by using the number keypad *(0)* - *(9)* . After entering the area code, press *(select/channel)* .
- 4 After you have made your selections, press *(options)* and return the handset to the base.

```
1# Auto Talk: Off
2 CIDCW      : On
3 Area Code:
```

WHEN THE TELEPHONE RINGS

- When the Caller ID message is received, the display shows the caller's phone number along with the date and time. The incoming call information is stored in the Caller ID record. If the Caller ID service includes the caller's name, the caller's name appears on the display (up to 15 letters).

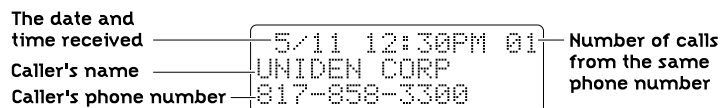

Here are some typical displays;

When the phone number and name data are received

```

5/11 12:30PM 01
UNIDEN CORP
817-858-3300
  
```

When a private name is received

```

5/11 12:30PM 01
Private Name
817-858-3300
  
```

When an unknown name is received

```

5/11 12:30PM 01
Unknown Name
817-858-3300
  
```

When invalid data is received

```

Incomplete Data
  
```

When a private number is received

```

5/11 12:30PM 01
UNIDEN CORP
Private Number
  
```

When an unknown number is received

```

5/11 12:30PM 01
UNIDEN CORP
Unknown Number
  
```

- When you pick up the phone, the display changes to "Talk". (See page 16.)



Data errors appear as " ■ ■ ".

```

5/11 12:30PM 01
UNI ■ EN CORP
813-8 ■ ■ -3300
  
```



- If you answer a call before the Caller ID message is received (Example: before the second ring), the Caller ID message will not appear.
- When the call is received via a telephone company that does not offer Caller ID service, the caller's phone number and name do not appear. (This includes international calls.)
- When the call is via a private branch exchange (PBX), the caller's phone number and name may not appear.



- In Caller ID operation, if no key is pressed for more than 20 seconds, an error tone sounds and the telephone returns to the standby mode.

- If a call comes in via a telephone system that does not offer Caller ID service, no information is stored.

- "End" appears when you have reviewed all messages in the Caller ID list. Press  repeatedly to return to the summary screen.

- Each message can be up to 15 characters for the phone number and the name.

V I E W I N G T H E C A L L E R I D M E S S A G E L I S T

The Caller ID list stores information for up to 50 incoming calls even unanswered calls.

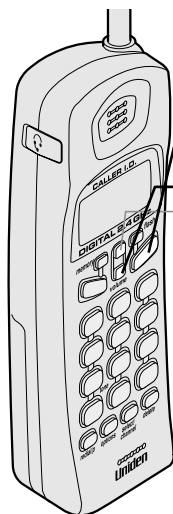

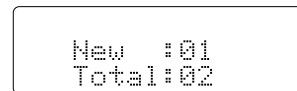

1 Press  .
The summary screen appears.
The screen shows the number of new messages and total messages.

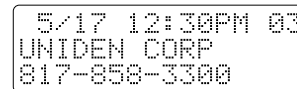

2 Press  to display the latest caller ID message.



3 Press  to see the next message, or press  to see previous message.

4 Press  to return to standby.

DELETING INFORMATION FROM THE CALLER ID LIST

The TRU 246 stores up to 50 messages. If the phone receives the 51st message, the oldest one in the list is automatically deleted.

Caller ID data can also be deleted manually.

Deleting a Caller ID message

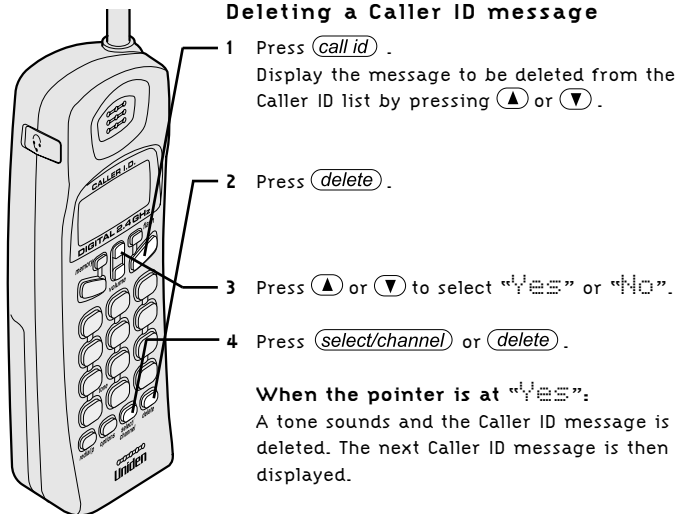

1 Press **call id** .
Display the message to be deleted from the Caller ID list by pressing **▲** or **▼** .

2 Press **delete** .

3 Press **▲** or **▼** to select "Yes" or "No".

4 Press **select/channel** or **delete** .

When the pointer is at "Yes":

A tone sounds and the Caller ID message is deleted. The next Caller ID message is then displayed.

When the pointer is at "No":

The display returns to the Caller ID display.

```
5/17 12:30PM 03
UNIDEN CORP
817-858-3300
```

```
Delete Message?
▶Yes
No
```



If you get an incoming call or page, the deleting operation is cancelled. The telephone returns to standby so you can answer the call or page.



If you get an incoming call or page, the deleting operation is canceled and the telephone returns to standby so you can answer the call or page.

Deleting all Caller ID names/numbers

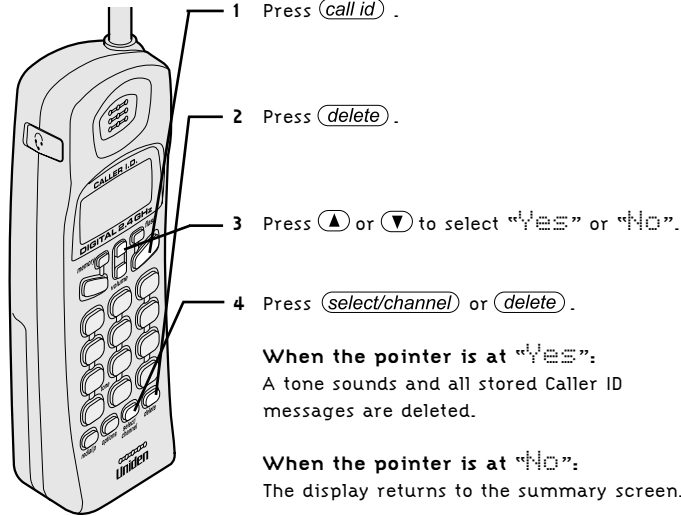

1 Press **call id** .

2 Press **delete** .

3 Press **▲** or **▼** to select "Yes" or "No".

4 Press **select/channel** or **delete** .

When the pointer is at "Yes":
A tone sounds and all stored Caller ID messages are deleted.

When the pointer is at "No":
The display returns to the summary screen.

```
New :01  
Total:02
```

```
Delete All?  
Yes  
No
```

```
Total:00
```

```
New :01  
Total:02
```

USING THE CALLER ID LIST

Calling a party from the Caller ID list

You can place a call from the Caller ID list. The TRU 246 stores up to 50 messages.

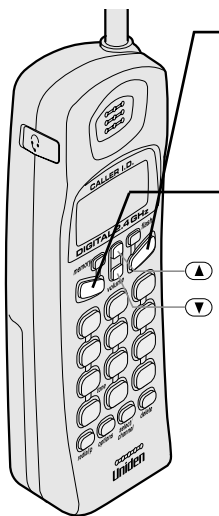

- 1 Press **call id** .
Select the phone number that you want to dial by pressing **▲** or **▼** .

```
5/17 12:30PM 03
UNIDEN CORP
817-858-3300
```

- 2 Press **talk** .
The displayed phone number will be dialed automatically.

```
Talk
8178583300
```

Long Distance call and Area Code setting

Pressing **1** while the incoming call information is displayed (in step 1) will set or cancel a Long Distance call. Pressing **3** will set or cancel the area code setting.

Dial edit

You can edit the phone number of Caller ID data when you press **select/channel** after step 1.

note

- You cannot make a call from the Caller ID list if your TRU 246 is connected to private branch exchange (PBX).
- When a long distance call has been set, "1" appears in the display.



- You can not store a Caller ID message if no phone number appears in the message.
- If there is an incoming call or page, memory storage is canceled and the telephone is set to receive the incoming call or page.

Storing Caller ID messages in Memory dialing

The phone number of the party on the Caller ID list can be stored in memory dialing.

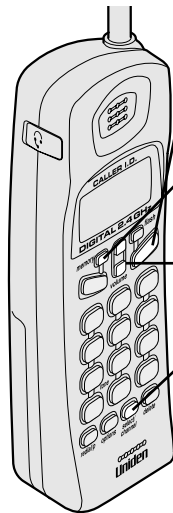

1 Press **call id** .
Select the phone number to be stored from the Caller ID list by pressing **▲** or **▼** .

2 Press **memory** .

3 Press **▲** and **▼** or enter a two-digit number (01 - 20) to select the memory location.

4 Press **select/channel** .
A confirmation tone will sound. The number is stored in memory, and the display returns to the Caller ID list.

```
5/17 12:30PM 03  
UNIDEN CORP  
817-858-3300
```

```
Select Location  
01 UNIDEN CORP  
02 JONE DOE
```

```
5/17 12:30PM 03  
UNIDEN CORP  
817-858-3300
```

Long Distance call and Area Code setting

When you need to store Long Distance call prefix "1" and area code, edit the number at step 1. Press **1** for Long Distance call and **3** for area code setting.



If a message has already been stored in the selected memory number location, a confirmation screen is displayed. Press **▲** to select "Yes". Press **select/channel** to overwrite. The display returns to the Caller ID list.

```
Replace Memory?  
Yes  
No
```

USING “CALLER ID ON CALL WAITING” SERVICE

“Caller ID” and “Call waiting” are separate services. CIDCW (Caller ID on Call Waiting) performs the same as regular Caller ID on a call waiting number. You must subscribe to the “Caller ID on call waiting (CIDCW) services” before you can use the following features. The “Call waiting” service can also be used independently. Please contact your local telephone company for details.

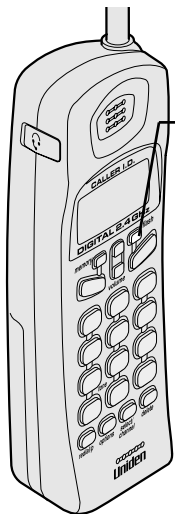

- 1 When a new incoming call is received during your current telephone call, the phone number and the name of the caller are displayed.
- 2 Press **(flash)** .
You will be able to talk with the second caller. The first caller will be put on hold.
- 3 To return to the first caller, press **(flash)** again.

```
Talk 10:30
UNIDEN CORP
817-858-3300
```



When CIDCW is set to **OFF** in the Caller ID setup menu (see page 28), you can press the **(options)** key after receiving a call waiting call and view a list of ways to handle the new call. Choose an option using the **(▲)** and **(▼)** keys and press **(select/channel)** to activate.

CALL WAITING FEATURES

Your TRU 246 gives you new options for call waiting. At the touch of a button, you can ask the caller to hold, send them to your voice mail service, or conference them into your current call. You may be required to subscribe to a voice mail service, call waiting, and call waiting options to use these features. Not all features are available in all areas. Check with your local telephone company for details.



You can also answer a call waiting call immediately by pressing the **(flash)** key. The first caller will be placed on hold. To return to the original caller, press **(flash)** again.

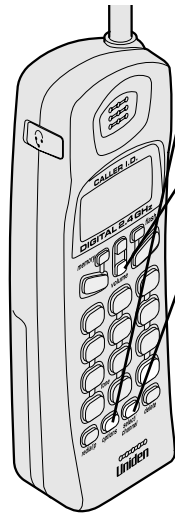

Selecting an Option

1 When you receive a call waiting call, press **(options)** for a list of options.

2 Press **(▲)** and **(▼)** keys or a number key (1-7) to select an option.

3 Press **(select/channel)** .
A confirmation screen will appear.

```
1▶ Ask to Hold
2 Tell Busy
3 Take Message
```

```
Talk 0:15
Call Holding
```

Your TRU 246 is pre-programmed with seven call waiting options. You may select to ask the calling party to **hold**, send them a **busy** message, **forward** them to your voice mail service or **conference** them into the current call. You may also select to **answer and drop** the first caller or, at any time, choose to **drop the first or drop the last** caller.

Check with your local telephone company for a full list of options.

CHANGING THE DIGITAL SECURITY CODE

The digital security code is an identification code used to connect the handset and the base unit. Normally, setting the code is not necessary.

The first time you charge your handset, the security code is automatically set. (See page 4.)

In the rare situation that you suspect another cordless telephone is using the same security code, you can change the code.

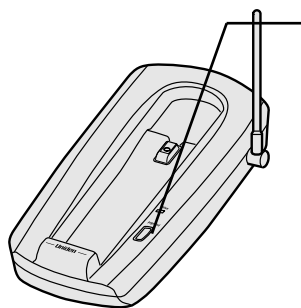

- 1 Remove the handset from the base unit. Press and hold page/find .
- 2 While the handset is emitting the paging sound, hold and replace the handset on the base unit. The paging tone stops. Leave the handset on the base for more than 3 seconds. A random, new security code is set.



If the handset battery pack is completely discharged or the battery pack is removed, the digital security code will be lost. If this happens, a new security code is set automatically next time the battery pack is charged.



If you have wall mounted the base, you cannot place the handset with the keypad facing inside.

BELTCLIP INSTALLATION

To attach the beltclip

Insert the beltclip into the holes on each side of the handset. Press down until it clicks.

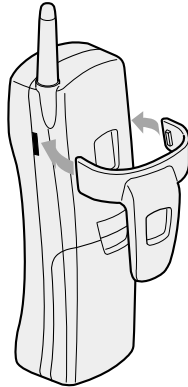

To remove the beltclip

Pull both sides of the beltclip to release the tabs from the holes.

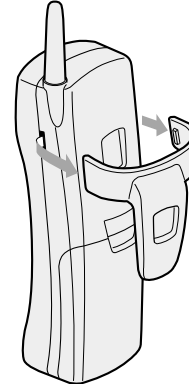

HEADSET INSTALLATION

Your phone may be used with an optional headset, the Uniden HS910. To use this feature, simply plug the headset plug into the headset jack. Your phone is ready for hands-free conversation.

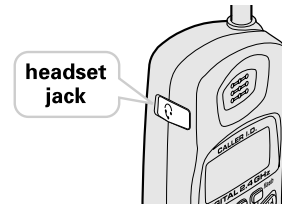

NOTE ON POWER SOURCES

Battery replacement and handling

When the operating time becomes short, even after a battery is recharged, please replace the battery.

With normal usage, your battery should last about one year.

Please contact your place of purchase for a replacement battery.

Power Failure

During the period that the power is off, you will not be able to make or receive calls with the telephone.

RECYCLING NICKEL-CADMIUM BATTERIES



Nickel-cadmium cells are used in the battery pack. Please take your used nickel-cadmium battery packs to a store that recycles nickel-cadmium batteries.

Caution

- Use the specified battery pack.
- Do not remove the battery from the handset to charge it.
- Never throw the battery into a fire, disassemble it, or heat it.
- Do not remove or damage the battery casing.

MAINTENANCE

When slightly dirty

Wipe with a soft, dry cloth.

When very dirty

Wipe with a soft cloth that has been dampened with diluted, neutral detergent. Dry with a dry cloth.

When the charging terminals become dirty

Wipe with a dry cloth or a pencil eraser, if necessary.

Caution

Do not use paint thinner, benzene, alcohol, or other chemical products. Doing so may discolor the surface of the telephone and damage the finish.

TROUBLESHOOTING

If your phone is not performing to your expectations, please try these simple steps first.

Symptom	Suggestion
The status LED won't light on when the handset is placed in the base unit.	<ul style="list-style-type: none">• Make sure the AC adapter is plugged into the base unit and wall outlet.• Make sure the handset is properly seated in the base unit.• Make sure the charging contacts on the handset and base unit are clean.
The audio sounds weak and/or scratchy.	<ul style="list-style-type: none">• Press (select/channel) during a call to help eliminate background noise.• Make sure that the base unit antenna is in a vertical position.• Move the handset and or base unit to a different location away from metal objects or appliances and try again.• Make sure that you are not too far from the base.
Can't make or receive calls.	<ul style="list-style-type: none">• Check both ends of the base unit telephone line cord.• Make sure the AC adapter is plugged into the base unit and wall outlet.• Disconnect the AC adapter for a few minutes, then reconnect it.• Reset the digital security code (See page 37).• Make sure (talk) is pressed.
The handset doesn't ring or receive a page.	<ul style="list-style-type: none">• The battery pack may be weak. Charge the battery on the base unit for 15-20 hours.• The handset may be too far away from the base unit.• Place the base unit away from appliances or metal objects.• Reset the digital security code (See page 37).

Symptom	Suggestion
The Caller ID does not display.	<ul style="list-style-type: none"> • The handset was picked up before the second ring. • The call was placed through a switch board. • Call your local telephone company to verify your Caller ID service is current.
Severe noise interference.	<ul style="list-style-type: none"> • Keep the handset away from microwave ovens, computers, remote control toys, wireless microphones, alarm systems, intercoms, room monitors, fluorescent lights, and electrical appliances. • Move to another location or turn off the source of interference.

I N D E X

A

Adjusting ringer and earpiece volume . . . 13

B

Battery pack

 Preparing and charging 11

 Replacement and handling 39

Beltclip installation 38

C

Caller ID

Caller ID service 27

 Call Waiting 35

 Deleting 31

 Setting

 Caller ID options 27

 Using 33

 Viewing 30

Connection 7

D

Dialing mode 8

Digital security code 4,37

E, F, G

Earpiece volume 13

H, I, J, K, L

Headset installation 38

M, N, O

Maintenance 39

Making a call 14

Memory dialing

 Making calls with memory dialing . . . 21

 Erasing a stored name

 and phone number 25

 Storing phone

 numbers and names 19

Mounting the base unit on a wall 9

P, Q

Package contents 5

Paging 26

R

Receiving a call 16

Redialing a call 17

Ringer tone and volume 13

S

Setting up the Base unit 6

Setting up the Handset 11

T, U, V, W, X, Y, Z

Troubleshooting 40

M E M O

M E M O

At Uniden, we'll take care of you!

If you need any assistance with this product, please call our Customer Hotline at

1-800-297-1023

PLEASE DO NOT RETURN THIS PRODUCT TO THE PLACE OF PURCHASE.

Our Uniden representatives will be happy to help you with any matters regarding the operation of this unit, available accessories, or any other related matters.

Thank you for purchasing a Uniden product.

Hours: M-F 7:00 AM to 7:00 PM CST.

THANK YOU FOR PURCHASING YOUR UNIDEN CORDLESS PHONE.

A World Without Wires | **Uniden**[®]

Covered under one or more of the following U.S. patents:
4,511,761 4,523,058 4,595,795 4,797,916 5,381,460 5,426,690
5,434,905 5,491,745 5,533,010 5,574,727 5,650,790 5,660,269
5,661,780 5,663,981 5,671,248 5,717,312 5,754,407 5,768,345
5,787,356 5,838,721 5,864,619 5,893,034 5,912,968 5,915,227
5,929,598 5,930,720 5,960,358 5,987,330

©2000 Uniden America Corporation
All rights reserved
UC2201703BZ