



EXS 9950

OWNER'S MANUAL

Digital Spread
Spectrum Provides
the Longest Range,
the Clearest
Sound, and the
Best Privacy

Uniden®

INTRODUCTION

TO YOUR NEW PHONE

Introduction

Thank you for choosing the Uniden EXS 9950 cordless telephone. This phone is designed for reliability, long life, and outstanding performance utilizing the latest in 900 MHz Spread Spectrum technology.

Note: Some illustrations in this manual may differ from the actual unit for explanation purposes.

Features

- 900 MHz Spread Spectrum Technology
- Stand Alone Telephone Answering Device (STAD)
- 20 Enhanced Memory Dial Location
- 4 One-touch Memory Locations
- 32 Digit Redial
- 2nd Battery Capability
- Flash and Pause
- Redial
- Pulse / Tone Dialing
- Page
- 4 Hour Talk Time
- 7 Day Standby Battery Time
- Handset Earpiece and Ringer Volume Control
- Hearing Aid Compatible

Digital Spread Spectrum Technology utilizes a “wider frequency band” vs. a “single narrow band” used in standard digital transmissions. The result is a more secure conversation with the clarity of digital sound, extended range, and minimal interference from other cordless phone.

Random Code™ digital security automatically selects one of over 65,000 codes for the handset and base.

These features enhance your phone's security and also prevent unauthorized calls as a result of your phone being activated by other equipment.

Controls and functions

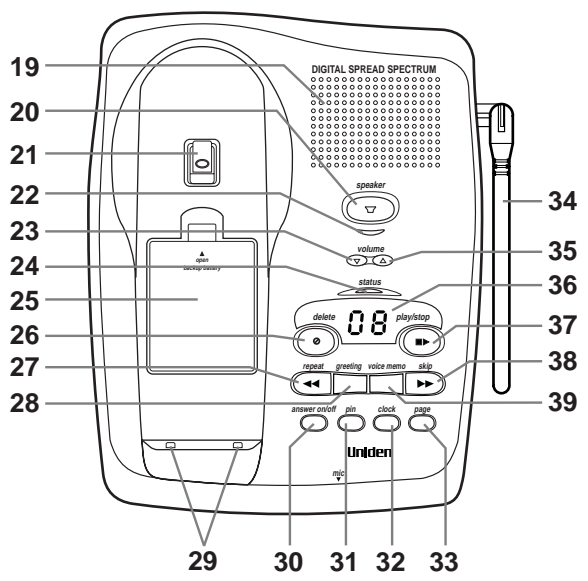
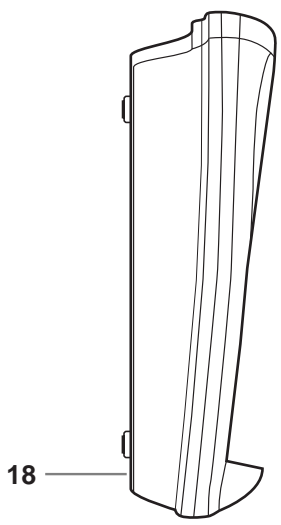
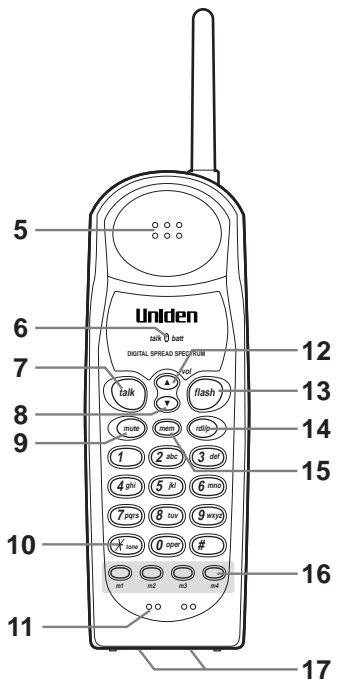
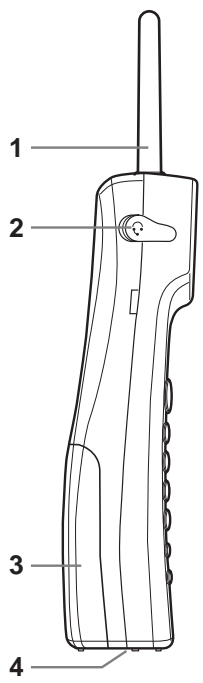

1. Handset antenna
2. Headset jack cover
3. Handset battery compartment
4. Ringer on/off switch
5. Handset speaker
6. Talk/Batt LED
7. Talk key
8. Volume down key
9. Mute key
10. Tone key
11. Handset microphone
12. Volume up key
13. Flash key
14. Redial/Pause key
15. Memory key
16. One-touch memory keys
17. Handset charge contacts
18. Base microphone
19. Base speaker
20. Speaker key
21. Handset retainer clip
22. Speaker LED
23. Volume down key
24. Status LED
25. Spare battery compartment
26. Delete key
27. Repeat key
28. Greeting key
29. Base charge contacts
30. Answer on/off key
31. Pin code key
32. Clock key
33. Page key
34. Base antenna
35. Volume up key
36. LED display
37. Play/Stop key
38. Skip key
39. Voice memo record key
40. Record time switch
41. Ring time switch
42. Ring volume switch
43. Pulse-Tone switch
44. DC power input
45. Tel line jack

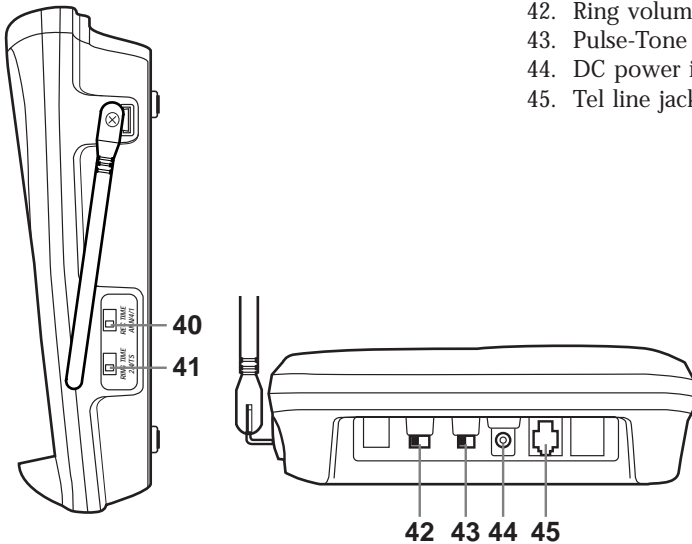

CONTENTS

OF YOUR OWNER'S MANUAL

Contents

Introduction / Features.....inside front cover
Controls and Functionsinside front cover

Getting Started

Read this first.....3
Step 1: Checking the package contents.....4
Step 2: Setting up the base unit5
 Mounting the base unit on a wall8
Step 3: Installing the handset battery pack.....10
 Charging optional battery packs11
 Automatic digital code security12

Basics

Making a call13
Receiving a call14
Flash and Call Waiting15
Adjusting the ringer and earpiece volume15
Redialing a call16
Mute16

Memory Dialing

Storing phone numbers17
Making calls with memory dialing.....18
Erasing a stored phone number.....19

3-way Conference Features

Using page feature20
3-way conferencing.....21

The Integrated Answering Device

Features.....22
Setting up your answering system23
Using your answering system27

Additional Information

Installing the beltclip.....33
Headset installation33
Note on power sources34
Maintenance.....34

Troubleshooting.....35

Specifications.....37

Index38

Getting Started

Basics

Memory Dialing

3-way
Conference
Features

The Integrated
Answering
Device

Additional
Information

Troubleshooting

Specifications

Index

Read this first

This cordless telephone must be set up before use. Follow these steps:

Step 1 (page 4)

Unpack and check the telephone and accessories.

Step 2 (page 5 to 9)

Next, choose the best location to set up the base unit.

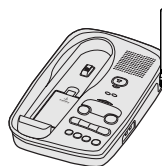

Base unit

Step 3 (page 10 to 12)

Then, insert the battery pack into the handset. You have to charge the battery pack for more than 17 hours before using the phone.



Handset

About the digital security code

This cordless telephone uses a digital security code to prevent unauthorized access to your base unit. This security code prevents other cordless handsets from making calls through your base unit. A random security code will be assigned automatically between your base unit and handset when you charge the battery pack for the first time.

Checking the package contents

Make sure you have received the following items in the package. If any of these items are missing or damaged, contact the **Uniden Parts Department** (see below).

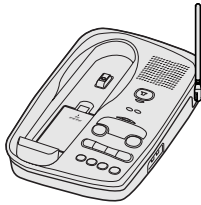

• Base unit



• Handset

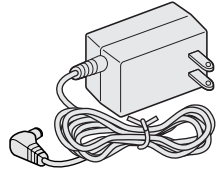

• AC adapter (AD-9500)

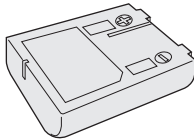

• Rechargeable battery pack (BT-999)

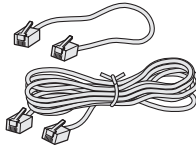

• Telephone line cord (Long, Short)

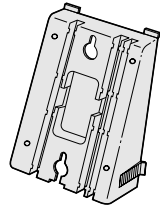

• Wall mount adapter

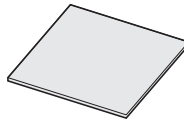

• Memo sticker

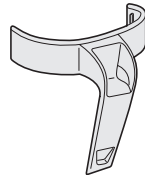

• Beltclip

- This Owner's Manual
- Precautions and Important Safety Instructions
- Registration Card

Uniden Parts Department

(800) 554-3988

Hours: M-F 8:30 AM to 5:00 PM CST.

We can also be reached on the web at www.uniden.com.

Setting up the base

Do the following steps.

- Choose the best location
- Connect the base unit
- Choose the dialing mode

Choose the best location

Before choosing a location for your new phone, read the INSTALLATION CONSIDERATIONS included in the PRECAUTIONS AND IMPORTANT SAFETY INSTRUCTIONS brochure. Here are some important guidelines you should consider:

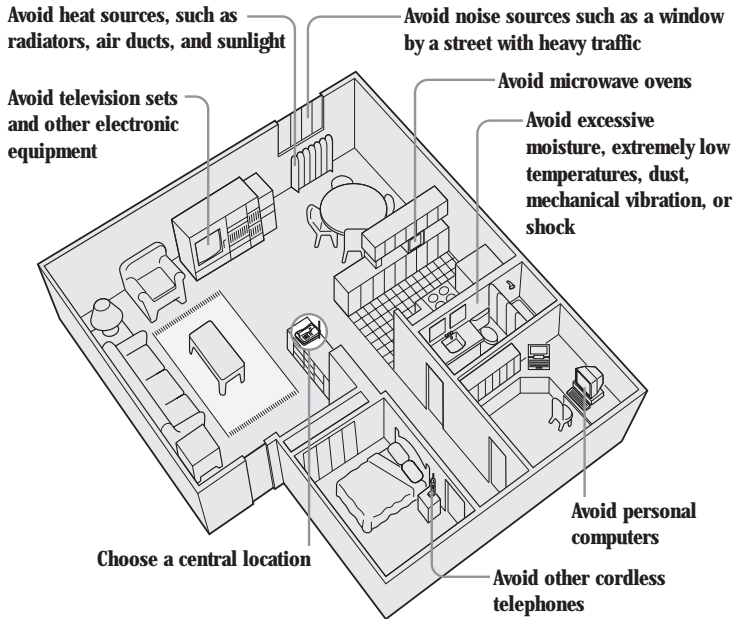

- You should charge your handset for more than 17 hours before using the phone.
- The location should be close to both a Tel line jack and continuous a power outlet which is not switchable.
- Keep the base and handset away from sources of electrical noise such as motors and fluorescent lighting.
- Be sure there is sufficient space to raise the base antenna fully vertical.
- The base can be placed on a desk, tabletop or mounted on a standard wall plate.

Connect the base unit

If you want to install the base unit on the wall, see page 8.

NOTE

Place the power cord so it does not create a trip hazard, or where it could become chafed and create a fire or electrical hazard.

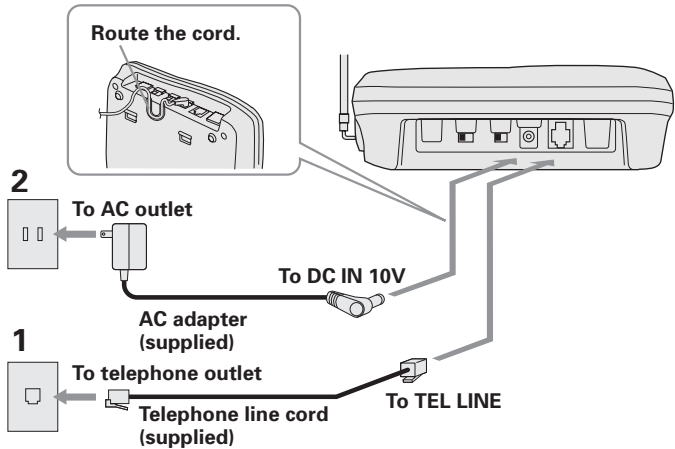

- 1 Connect the telephone line cord to the **TEL LINE** jack and to a telephone outlet.
- 2 Connect the AC adapter to the **DC IN 10V** jack and to a standard 120V AC wall outlet.
- 3 Set the base unit on a desk or tabletop and place the handset on the base unit. Then raise the antenna to a vertical position.

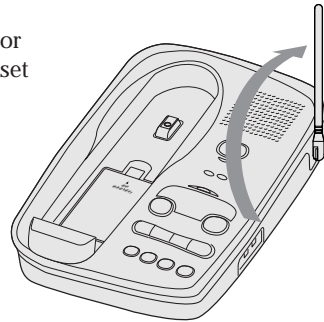



Use only the supplied AD-9500 AC adapter. Do not use any other AC adapter.

Polarity of the plug

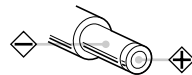

Connect the AC adapter to a continuous power supply.



Place the base unit close to the AC outlet so that you can unplug the AC adapter easily.



If your telephone outlet isn't modular, contact your telephone company for assistance.

Modular



Choose the dialing mode

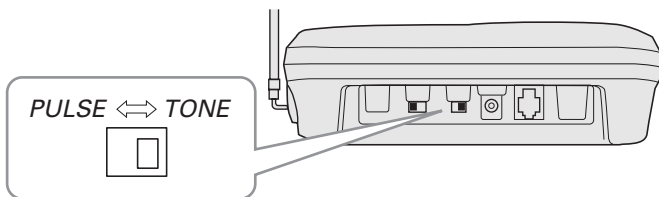

Depending on your dialing system, set the **PULSE-TONE** switch as follows:

If your dialing system is	Set the switch to
Tone	<i>TONE</i>
Pulse	<i>PULSE</i>

If you aren't sure of your dialing system

Make a trial call with the **PULSE-TONE** switch set to ***TONE***. If the call connects, leave the switch as is; otherwise, set to ***PULSE***.

Mounting the base unit on a wall

Standard wall plate mounting

This phone can be mounted on any standard telephone wall plate.

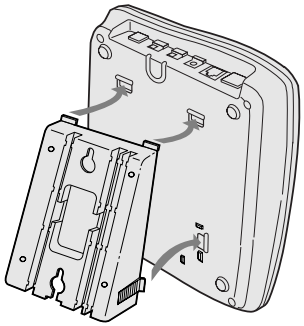
- 

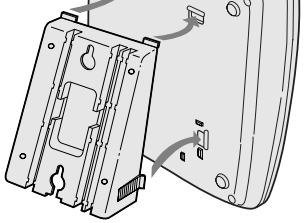
1 Snap the wall mount adapter into the notches on the base.
- 

2 Plug the telephone line cord to the **TEL LINE** jack and the AC adapter to the **DC IN 10V** jack.
- 

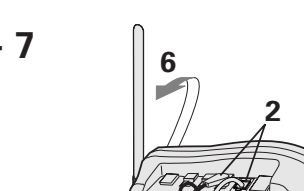
3 Plug the telephone line cord into the telephone outlet.
- 

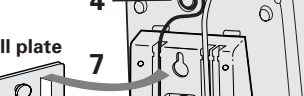
4 Wrap the AC adapter cord inside the molded wiring channel. Then wrap the cord around the strain relief notch.
- 

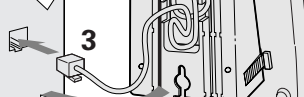
5 Plug the AC adapter into a standard 120V AC wall outlet.
- 

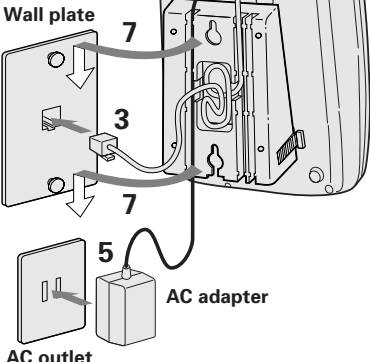
6 Raise the antenna to a vertical position.
- 

7 Align the mounting slots on the base with the mounting posts on the wall. Push in and down until the phone is firmly seated.

NOTE

If you have wall mounted the base, you must remove the beltclip to charge the handset facing forward.

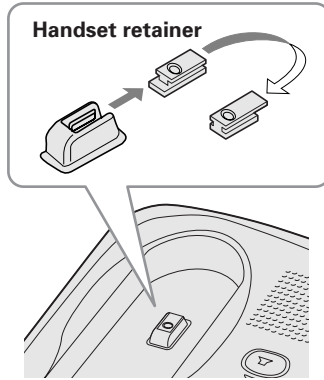

8 On the base unit, pull the handset retainer out of the slot. Rotate it clockwise 180 degrees.

9 Flip the retainer from front to back. Slide it back into the slot so that the lip of the retainer is up and the oval is down. The retainer holds the handset in place.

Direct wall plate mounting

If you don't have a standard wall plate, you can mount your phone directly to the wall. Before doing this, consider the following:

- Avoid electrical cables, pipes, or other items behind the mounting location, that could cause a hazard when inserting screws into the wall.
- Try to mount your phone within 10 - 15 feet of a working phone jack to avoid excessive cord lengths.
- Make sure the wall material is capable of supporting the weight of the base and handset.

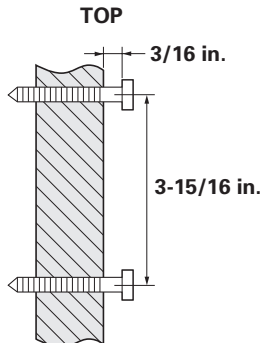

1 Insert two mounting screws into the wall, (with their appropriate anchoring device), 3-15/16 inches apart. Allow about 3/16 of an inch between the wall and screwheads for mounting the phone.

2 Refer to steps 1 through 9 on page 8 and 9 to mount the telephone.

Installing the handset battery pack

Charge the battery pack for more than 17 hours before you start using your phone.

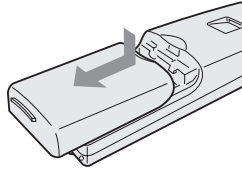

- 1** Press in on the battery cover release and slide the cover down until it comes off.

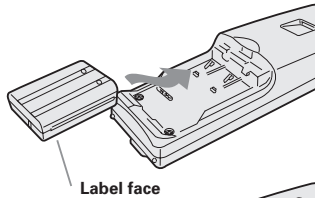

- 2** Install the nickel-cadmium battery with the label facing down.

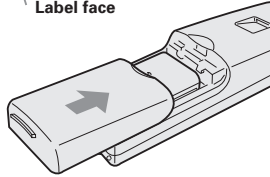

- 3** Slide the battery cover on until it snaps into place.

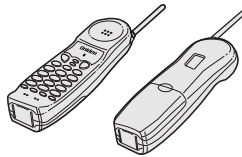

- 4** Place the handset on the base.

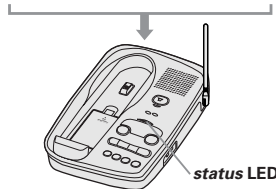

- 5** Make sure that the "*status*" LED lights. If the LED doesn't light, check to see that the AC adapter is plugged in and that the handset makes good contact with the base charging contacts.



Use only Uniden Battery (BT-999) supplied with your phone.

NOTE

Even when the battery pack is not being used, it will gradually discharge over a long period. For optimum performance, be sure to return the handset to the base unit after a telephone call for charging the battery.

NOTE

Rechargeable batteries have a memory effect that reduces standby and talk time. To avoid this memory effect, on a monthly basis, use the phone until the **talk/batt** LED blinks. Then charge the battery for more than 17 hours.

NOTE

Please visit your authorized Uniden dealer to obtain an extra battery pack or contact the Uniden parts department at (800)554-3988. Hours are from 8:30 a.m. to 5:00 p.m. Central Time, Monday through Friday.

Battery use time (per charge)

From fully charged

- Four hours continuous use.
- Seven days when the handset is in the standby mode.

When the battery charge becomes low

When the voltage of battery pack in the handset is very low and needs to be charged, the phone is programmed to eliminate functions in order to save power. If the battery charge becomes **talk/batt** LED blinks. If the phone is in use, the handset beeps. Complete your conversation as quickly as possible and return the handset to the base unit for charging.

Cleaning the battery contacts

To maintain a good charge, it is important to clean the battery contacts on the handset and base unit about once a month. Use a pencil eraser or other contact cleaner.

Do not use any liquids or solvents.

Charging optional battery packs

The base unit of your phone is equipped with a compartment for charging an extra battery pack for use in your handset. **You can obtain an extra battery pack from your authorized Uniden dealer.**

1. Pull the cover of battery charger.
2. Put the battery pack in the compartment with contacts facing down.
3. Charge the battery for 24 hours.
To install the charged battery into the handset, refer to "Installing the handset battery pack", page 10.

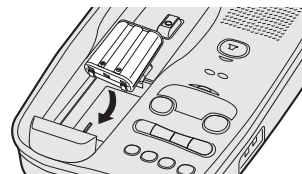
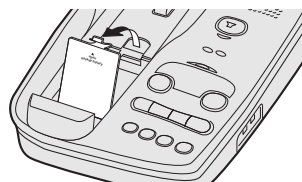

NOTE

In the event of a power failure, your spare battery pack can be used as a back-up power supply for the base unit.

Automatic digital code security

To prevent other parties from making unauthorized calls on your phone line, a digital code was added to the EXS 9950. Your phone's handset and base share this code, which is randomly set each time you place the handset on the base.

Making a call

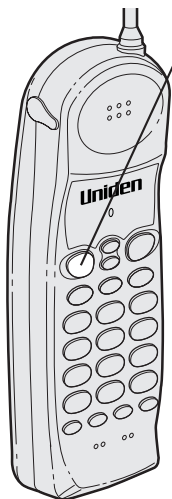

- 1 Press **(talk)**. The **talk/batt** LED lights.
- 2 Dial the phone number.
- 3 To hang up, press **(talk)** or return the handset to the base.

NOTE

The phone number can be up to 32 digits.

NOTE

If the **talk/batt** LED never stop flashing, place the handset on the base for at least three seconds and make a call again.

Other Operations

To	Do this
To adjust the ear speaker volume	Press (▲) or (▼) during the call.
To temporarily switch to tone dial (When the base is set to pulse mode)	Press (* tone) . The following numbers dialed will be sent as tone dialing.
To enter a pause within dialing sequence	Press (rdl/p) .

Receiving a call

From the handset

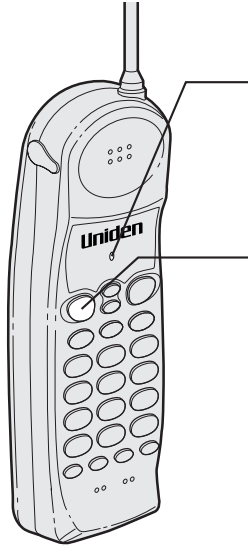

Handset on the base

- 1 Phone rings. The **talk/batt** LED flashes.
- 2 Pick up the handset and begin speaking.
- 3 To hang up, press **talk** or return the handset to the base.

Handset off the base

- 1 Phone rings. The **talk/batt** LED flashes.
- 2 Press **talk** and begin speaking.
- 3 To hang up, press **talk** or return the handset to the base.

From the base

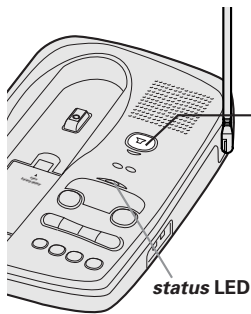

- 1 The phone rings. The **status** LED on the base flashes.
- 2 Press **speaker** and begin speaking.
- 3 To hang up, press **speaker**.

Flash and Call Waiting

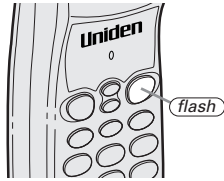

If you have “Call Waiting” service and a call waiting tone sounds while you are on a call, press **(flash)** to accept the waiting call. There is a short pause, then you will hear the new caller. To return to the original caller, press **(flash)** again.

Adjusting the ringer and earpiece volume

Handset ringer tone

The phone has four types of ringer tone. In the standby mode, press **(flash)** and one of **(1) - (4)**.

Handset ringer volume

In the standby mode, press **(▲)** for high and **(▼)** for low.

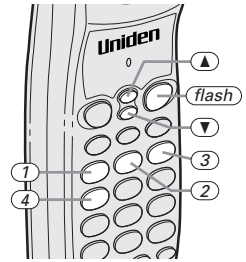

To turn off the ringer, set the **ringer on/off** switch to **off**.

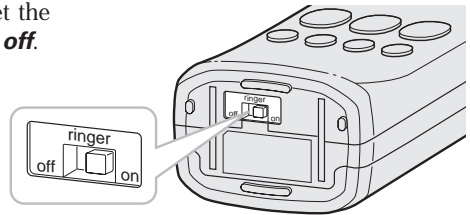

Handset earpiece volume

The phone has four earpiece volume levels, Normal, Medium, High, and Loud. Pressing **(▲)** or **(▼)** during a telephone call will change the earpiece volume of the handset. This setting will remain in effect after the telephone call has ended.

When you press **(▲)** in Hac mode or press **(▼)** in Normal mode, error sound beeps.

Base ringer switch

This switch turns the base ringer on or off.

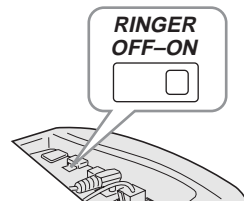

Base speaker volume

To control the speaker volume of the base, adjust the **volume ▲** and **volume ▼** button as desired.

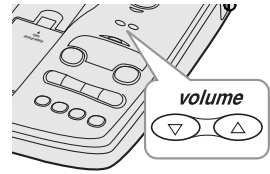

Redialing a call

The last phone number dialed can be quickly redialed.

NOTE

If the recently dialed number exceeds 32 digits, only the first 32 digits are retained for redialing.

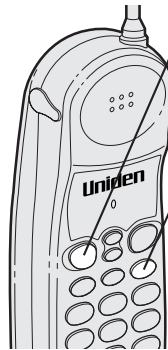

- 1 Press **talk**. The **talk/batt** LED lights.
- 2 Press **rdl/p**.
- 3 To hang up, press **talk** or place the handset on the base.

Mute

You can turn off the handset microphone so that the person you are talking with cannot hear you.

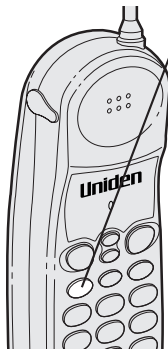

- 1 Press **mute** during a telephone call. The **talk/batt** LED blinks. The sound from the microphone is off.
- 2 To cancel mute, press **mute** again.

NOTE

You must press a key within 30 seconds or the phone will return to standby. If you return the handset in the cradle, the phone will return to standby too.

Storing phone numbers

Your EXS 9950 stores up to 24 numbers in handset (20 memory dials and 4 one-touch memory dials).

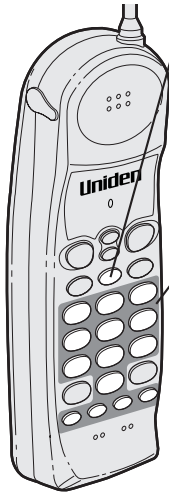

- 1 Press **mem** while in standby mode. The **talk/batt** LED flashes.
- 2 Dial the number you wish to store (up to 16 digits).
- 3 Press **mem** again.
- 4 Enter a two-digit number (01 - 20) or press One-touch memory key (**m1** - **m4**) to select the memory location where you wish to store the number.
- 5 The **talk/batt** LED goes out and the confirmation beep indicates the number has been stored.

NOTE

Use the supplied memo sticker to write stored number.

Making calls with memory dialing

Memory dialing



- 1 Press **(talk)**. The **talk/batt** LED lights.
- 2 Press **(mem)**.
- 3 Enter a two digit number (01 - 20) to select the memory location you wish to dial.
- 4 To hang up, press **(talk)** or return the handset to the base.

One-touch memory dialing

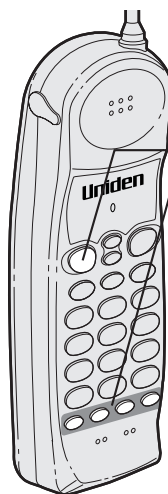

- 1 Press one of the One-touch memory keys (**(m1)** - **(m4)**) you wish to dial.
- 2 To hang up, press **(talk)** or return the handset to the base.

Erasing a stored phone number



- 1** Press **mem** in the standby mode. The **talk/batt** LED flashes.
- 2** Press **mem** again.
- 3** Enter the memory location number (01 - 20 or **m1** - **m4**) you wish to delete. A confirmation beep indicates the number has been erased.

Using page feature

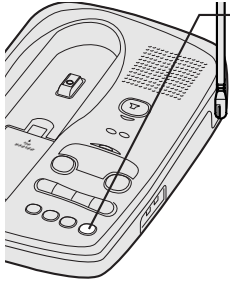

- 1** To locate the handset (while it's off the base), press **page** on the base. The handset beeps.
- 2** To stop paging, press **page** on the base or press **talk** on the handset. Replacing handset to the base also stops paging.



When you stop paging by pressing **talk** on the handset, press **talk** again or replace the handset to the base to return to the standby mode.

3-way conferencing

The Uniden EXS 9950 permits 3-way conversations between the handset, base and outside line.

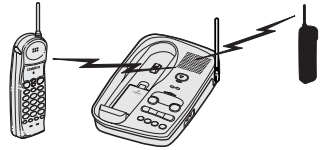

NOTE

Dialing is possible only from the handset during the 3-way conversation.

NOTE

If you pick up the handset from the base while speaking on the base, the call will be transferred to the handset.

When speaking on the handset

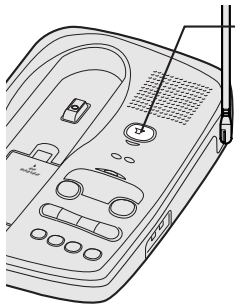

- 1 Press **speaker** on the base to join the 3-way conversation.
- 2 To hang up, press **speaker** on the base. The handset will still be connected to the outline call.

When speaking on the base

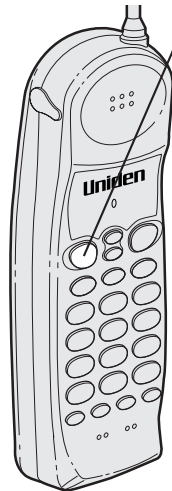

- 1 Press **talk** on the handset to join the 3-way conversation.
- 2 To hang up, press **talk** on the handset.

The integrated answering device

The EXS 9950 has a built-in answering system that answers and records incoming calls.

You can also use your answering system to record a conversation, leave a voice memo message for others who use the phone, or to announce a special message to callers when you're away from your phone.

Features

- Digital Tapeless Recording
- 15 minutes of Recording Time
- Selective Greetings (Outgoing Messages)
- Time and Day Stamp
- Remote Message Retrieval and Room Monitor
- Toll Saver
- Conversation Recording

Digital Tapeless Recording allows you to quickly review, save or delete the messages. You'll never have to worry about a tape wearing out, jamming, or resetting improperly.

The Integrated Answering System is easy and convenient to use, but please read through all of the instructions carefully.

NOTE

If you have not recorded your personal outgoing message when you turn the answering system on, the preset message is automatically set. To set your personal message, see page 24.

NOTE

Press **skip** or **repeat** multiple times to scroll through days, hours, minutes, etc.

NOTE

If you don't set the clock within two minutes, the system returns to standby.

Setting up your answering system

Turning the answering system on/off

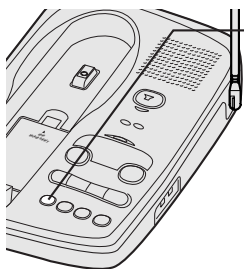

- 1 To turn the answering system on, press **answer on/off**. A tone will sound and the current greeting message is played.
- 2 To turn the answering system off, press **answer on/off** again.

Setting the clock

The clock on EXS 9950 Answer System starts when power is applied to the base. Follow these steps to set the clock to the correct time.

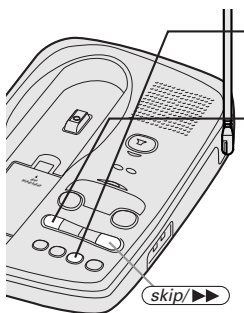

- 1 Press and hold **clock** until a tone sounds.
- 2 First, press **skip** or **repeat** the correct day of the week is announced. (Number 1 through 5 displays on the base as each day is announced.) Press **clock** again to select the day.
- 3 Next, press **skip** or **repeat** until you hear the correct hour setting. Numbers 1 through 12 display on the base as each hour is announced. Press **clock** again to select the correct time.
- 4 Press **skip** or **repeat** until you hear the correct time setting. Numbers 0 through 59 display on the base as each minute is announced. Press **clock** again to select the correct time.
- 5 The LED displays an **A** or **P**. Press **skip** or **repeat** until you hear the correct AM/PM setting.
- 6 Press **clock** again to end the time/day setting. The EXS 9950 announces the time that you have set.

Setting your greeting

When you receive a call, the answering system automatically plays either a preset message or your own greeting.

▼ Preset Message

The following message is prerecorded:

"Hello, no one is available to take your call. Please leave a message after the tone."

▼ Recording your personal outgoing message (Greeting)

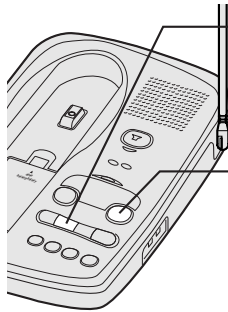

1 Press and hold **greeting** until you hear a long tone. Start recording your message immediately after you hear the long tone end.

2 When you finish recording your message, press **greeting** or **play/stop**. A long tone sounds and your message plays back on the phone.

NOTE

You can record a greeting up to 30 second.

NOTE

Stand within 12 inches in front of the microphone and speak clearly when recording your outgoing message.

▼ Choosing between the two outgoing messages

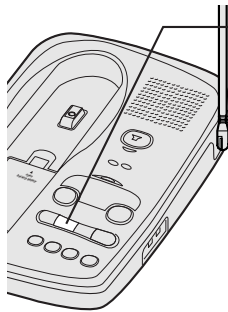

1 Press **greeting** to play the outgoing message.

2 Press **greeting** again while the message is played. This switches between the two options.

Selecting the message record time

You can set your answering system to record messages up to one or four minutes long.

One minute option:
move the **REC TIME**
switch to **1**.

Four minutes option:
move the **REC TIME**
switch to **4**.

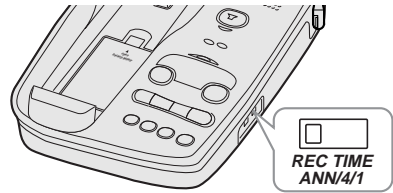

▼ Announce only feature:

The announce only feature plays an outgoing message, but it will not allow the caller to leave a message. Move the **REC TIME** switch to the **ANN** position.

The message counter LED displays "R" when system is on standby.

Prerecorded outgoing message for Announce only feature is:

"Hello, no one is available to take your call."

Selecting a PIN code

To play your messages from a remote location, you will need to enter a two-digit Personal Identification Number (PIN) code (00-99). To select a PIN, perform the following steps.

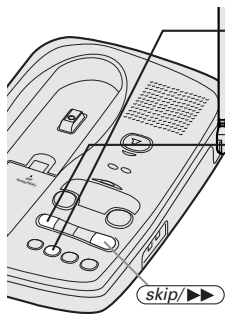

- 1** On the base, press and hold **(pin)** button until a tone sounds and the LED displays **00**.
- 2** To set the first number, press **(skip ▶▶)** or **(repeat ◀◀)** to scroll from 0 to 9. When the desired number appears in the display, press **(pin)**. This selects the first number.
- 3** To set the second number, press **(skip ▶▶)** or **(repeat ◀◀)** to scroll from 0 to 9. When the desired number appears in the display, press **(pin)**. This selects the second number and then the entered number is announced.

NOTE

Press **(skip ▶▶)** or **(repeat ◀◀)** multiple times to scroll through numbers on the display.

Setting ring time switch

The ring time/toll saver switch allows you to set the number of rings the caller hears before the answering system plays your outgoing message. You can set the switch to answer after two rings or after four rings.

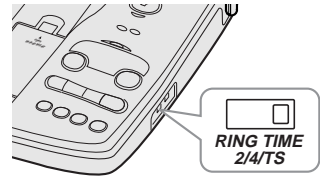

Once the greeting has started, you can stop it when you pick up the call at the handset or base.



If you answer at another phone extension and the greeting has started, you cannot stop the message. Wait until your greeting is complete before starting your conversation.

In the **TS** (Toll Saver) position, the answering system picks up after two rings if you have new messages, and after four rings if there are none. This way, if you the call long distance to check your messages, you can hang up after the third ring to avoid billing charges.

Using your answering system

NOTE

To stop playing your messages, press **(play/stop)** again.

Playing your messages

The base LED shows the number of total messages on the display. If the display is blinking, then there are new messages waiting for you. The EXS 9950 is designed to play your new messages first. After you play your new messages you can then play your old messages.

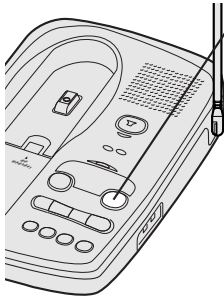

- 1** Press **(play/stop)**. The system announces the number of new and old messages, then the incoming messages are played. The time and day each message was received is announced after the message is played, and the message counter LED displays the number of the current message.
- 2** When all new messages have played, a long tone is heard. The message counter LED stops flashing to indicate that all of the new messages have been reviewed.
- 3** After you have reviewed all your messages, you can play your old messages again. Press **(play/stop)** and follow the instructions above.

NOTE

Pressing **repeat** (◀◀) before 2.5 seconds (4.5 seconds from remote) of the message has played causes the system to scan back one message.

NOTE

If you have several messages, press **repeat** (◀◀) until you return to the message you want to replay.

NOTE

Each time **skip** (▶▶) is pressed, the system scans forward one message.

NOTE

If you have several messages, press and hold **skip** (▶▶) to find the message you want to play.

Repeating a message

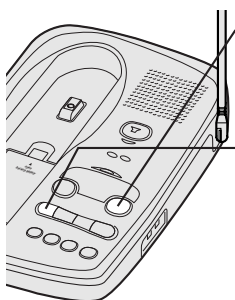

- 1 Press **play/stop** to review your message. The number of stored messages is announced.
- 2 After a message has played for a few seconds, press **repeat** (◀◀) to repeat the message.
- 3 Press **play/stop** at any time to stop reviewing messages and return to standby. The message counter LED shows the total number of messages still on the system.

Skipping a message

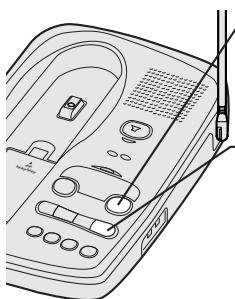

- 1 Press **play/stop** to review your messages. The number of messages is announced.
- 2 Press **skip** (▶▶) at anytime to skip to the next message.
- 3 Press **play/stop** at any time to stop reviewing your messages and return to standby. The message counter LED shows the total number of messages on the system.

NOTE

When you press **(delete)**, you are permanently deleting the message. Once deleted, the message cannot be replayed.

NOTE

The voice memo function is completely independent of the outgoing message. It's handy for leaving others a quick message.

NOTE

A voice memo message will be stored as a typical recorded message.

NOTE

Stand within 12 inches in front of the microphone and speak clearly.

Deleting a message

▼ Deleting individual message

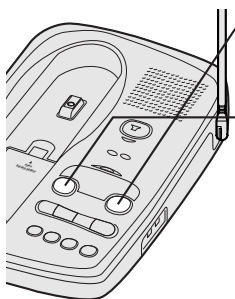

- 1 Press **(play/stop)** to review your message.
- 2 If you decide to delete a message, press **(delete)** anytime during the message. The system beeps and immediately goes to the next message.
- 3 After you have played all of your messages, a long tone sounds on the base speaker.

▼ Deleting all messages

Press and hold **(delete)** after reviewing your messages. A tone sounds when all messages are cleared.

Voice memo

The voice memo function allows the user to record a message (up to 10 minutes) on the base.

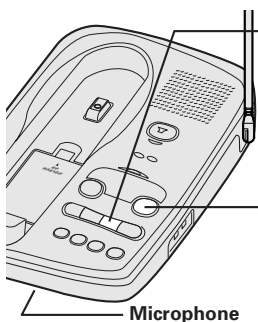

- 1 Press and hold **(voice memo)**, until you hear a long beep. The message counter LED blinks.
- 2 Speak into the microphone.
- 3 When you have finished, press **(voice memo)** or **(play/stop)** to stop recording. The system returns to standby.
- 4 To play voice memo, press **(play/stop)**.

Recording a conversation

You can record up to 10 minutes of conversation while you are making your call from the handset.

NOTE

A recorded conversation is stored and played back with typical recorded messages.

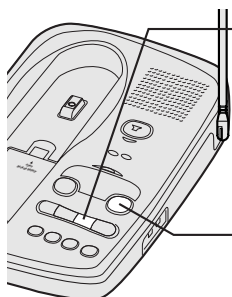

1 During the conversation from the handset, press and hold **(voice memo)** on the base. The unit begins recording and the LED blinks. A beep that can be heard by both parties sounds every 15 seconds.

2 To stop the recording, press **(voice memo)** or **(play/stop)**.

NOTE

You cannot record a conversation while you are speaking on the base.

Remote access away from home

You can operate your answering system from a remote location using any touch-tone telephone. Use this function to check for recorded messages, to play or delete messages, even to record a new outgoing message, and to monitor sounds in the room.

- 1 Call your telephone number.
- 2 During the answering machine is activated, press **#** and your PIN code.
- 3 The answering system announces the time and day stamp and the number of messages stored in memory. Then the message playback automatically begins.
- 4 You may continue to listen to your message, or you may select a command from the following chart.

Command	Function
# then 1	Repeat
# then 2	Playing your messages
# then 3	Skipping a message
# then 4	Deleting a message
# then 5	Stop message playback
# then 6	Answering system on
# then 7	Voice memo record/stop
# then 8	Outgoing message record/stop
# then 9	Answer system off
# then *	Room monitor

- 5 After all of your messages have played, or the playback time exceeds 4 minutes, you will hear that the intermittent beeps indicating that the system is in the command waiting mode. You may enter another command at this time from the chart above.
- 6 When you finish, hang up to exit the system. The answering system automatically returns to standby.

NOTE

You must enter a command within 15 seconds of entering command waiting mode or the answering system automatically hangs up and returns to standby.

NOTE

The system will only playback messages for four minutes and then it returns to command waiting mode. To continue playing your message, press **#** then **2** again within 15 seconds



NOTE

You can not use # and * while the new message are playing. Press # then 5 to stop Message playback first and go to step 4.

Remote room monitor

You can call your answering system from any touch-tone phone and monitor sounds in the room where your base is installed.

- 1** Call your telephone number.
- 2** While the answering machine is activated, press # and your PIN code.
- 3** The answering system begins announcing the time and day.
- 4** Press # then 5 to stop the messages.
- 5** Press # then *. You hear sounds in the room where your phone is installed. After 15 seconds, the answering system returns to the command waiting mode.
- 6** Press # then * to monitor the room for another 15 seconds. Or select another remote function. Or hang up to exit the system. The answering system automatically returns to standby.

NOTE

If you have wall mounted the base, you must remove the beltclip to charge the handset facing forward.

Installing the beltclip

To attach the beltclip

Insert the beltclip into the holes on each side of the handset. Press down until it clicks.

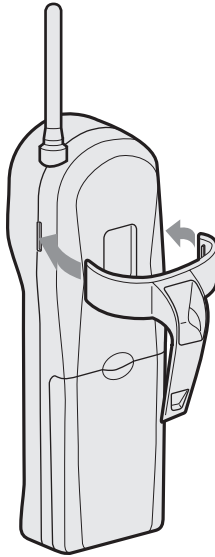

To remove the beltclip

Pull both sides of the beltclip to release the tabs from the holes.

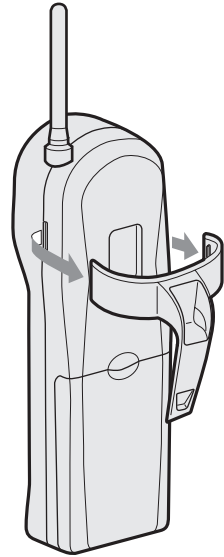

Headset installation

Your phone may be used with an optional headset. To use this feature, simply plug any standard 2.5mm headset plug into the headset jack. Your phone is ready for hands-free conversation.

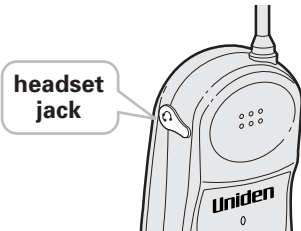

Note on power sources

Battery replacement and handling

When the operating time becomes short, even after a battery is recharged, please replace the battery.

With normal usage, your battery should last about one year.

Please contact your place of purchase for a replacement battery.

Power Failure

During the period that the power is off, you will not be able to make or receive calls with the telephone.

RECYCLING NICKEL-CADMIUM BATTERIES

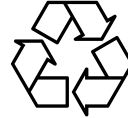

Ni-Cd

NICKEL-CADMIUM BATTERIES MUST BE DISPOSED OF PROPERLY.

Nickel-cadmium cells are used in the battery pack. Please take your used nickel-cadmium battery packs to a store that recycles nickel-cadmium batteries.

Caution

- Use the specified battery pack.
- Do not remove the battery from the handset to charge it.
- Never throw the battery into a fire, disassemble it, or heat it.
- Do not remove or damage the battery casing.

Maintenance

When slightly dirty

Wipe with a soft, dry cloth.

When very dirty

Wipe with a soft cloth that has been dampened with diluted, neutral detergent. Dry with a dry cloth.

When the charging terminals become dirty

Wipe with a pencil eraser or other contact cleaner.

Caution

Do not use paint thinner, benzene, alcohol, or other chemical products. Doing so may discolor the surface of the telephone and damage the finish.

Troubleshooting

If your phone is not performing to your expectations, please try these simple steps first.

Symptom	Suggestion
The status LED won't come on when the handset is placed in the base unit.	<ul style="list-style-type: none"> • Make sure the AC adapter is plugged into the base unit and wall outlet. • Make sure the handset is properly seated in the base unit. • Make sure the charging contacts on the handset and base unit are clean.
The audio sounds weak and/or scratchy.	<ul style="list-style-type: none"> • Make sure that the base unit antenna is in a vertical position. • Move the handset and or base unit to a different location away from metal objects or appliances and try again. • Make sure that you are not too far from the base.
Can't make or receive calls.	<ul style="list-style-type: none"> • Check both ends of the base unit telephone line cord. • Make sure the AC adapter is plugged into the base unit and wall outlet. • Disconnect the AC adapter for a few minutes, then reconnect it. • Make sure (talk) is pressed.
The handset doesn't ring or receive a page.	<ul style="list-style-type: none"> • The battery pack may be weak. Charge the battery on the base unit for more than 17 hours. • The handset may be too far away from the base unit. • Place the base unit away from appliances or metal objects. • Make sure the ringer on/off switch is set to on.

Symptom	Suggestion
The answering system does not work.	<ul style="list-style-type: none"> • Make sure the base unit is plugged in. • Make sure that the answering system is turned on.
Messages are incomplete.	<ul style="list-style-type: none"> • The incoming messages may be too long. Remind callers to leave a brief message. • The memory may be full. Delete some or all of the saved messages.
After a power failure, the outgoing message is deleted.	<ul style="list-style-type: none"> • Record your greeting again. The preset messages should remain.
No sounds on the base unit speaker during call monitoring or message playback.	<ul style="list-style-type: none"> • Adjust the speaker volume on the base unit.
Cannot access remote call-in features from another touch-tone phone.	<ul style="list-style-type: none"> • Make sure you are using the correct PIN number. • Make sure that the touch-tone phone you're using can transmit the tone for at least two seconds. If it cannot, you may have to use another phone to access your message.

Specifications

General

The EXS 9950 complies with FCC Parts 15 and 68.

Frequency control: PLL
 Modulation: Direct Sequence Spread Spectrum; DBPSK
 Operating temperature: 0°C to +50°C (+32°F to +122°F)

Base unit

Frequency: 904.2 MHz to 925.8 MHz (20 channel)
 Power requirements: 10V 500mA (from AC adapter)
 Size: 8-49/64 in. (W) x 6-57/64 in. (D) x 2-37/64 in. (H)
 (222.5 mm (W) x 175 mm (D) x 65.3 mm (H))
 Weight: Approx. 22.2 oz. (Approx. 630 g)

Handset

Frequency: 904.2 MHz to 925.8MHz (20 channel)
 Power requirements: Rechargeable Nickel-Cadmium battery pack
 Size (without antenna): 7 in. (W) x 2-17/64 in. (D) x 2 in. (H)
 (178 mm (W) x 57.6 mm (D) x 51 mm (H))
 Weight: Approx. 8.8 oz. (250 g) (including battery)
 Battery: BT-999
 Capacity 600 mAH, 3.6V
 Talk mode 4 hours TYP
 Standby mode 7 days TYP

Specifications, features, and availability of optional accessories are all subject to change without prior notice.

At Uniden, we'll take care of you!

If you need any assistance with this product, please call our Customer Hotline at

1-800-297-1023

PLEASE DO NOT RETURN THIS PRODUCT TO THE PLACE OF PURCHASE.

Our Uniden representatives will be happy to help you with any matters regarding the operation of this unit, available accessories, or any other related matters.

Thank you for purchasing a Uniden product.
 Hours: M-F 7:00 AM to 7:00 PM CST.

Index

0 - 9

3-way conferencing.....21

A

Answering device
 Features.....22
 Setting up.....23
 Using.....27

B

Base ringer switch.....15
 Battery pack
 Preparing and
 charging10
 Replacement and
 handling.....34

C

Connection.....6

D

Dialing mode.....7
 Digital security code3, 12

E, F, G

Earpiece volume.....15

H

Handset ringer tone15
 Headset installation33

I, J, K, L

Installing the beltclip.....33

M, N, O

Maintenance.....34
 Making a call13
 Memory dialing
 Making a call
 with memory dialing.....18
 Erasing a stored
 phone number.....19
 Storing phone
 numbers.....17
 Mounting the base unit
 to a wall.....8
 Mute16

P, Q

Package contents.....4

R

Receiving a call14
 Redialing a call16

S

Setting up your answering
 system
 Selecting a PIN code.....25
 Selecting the
 message record time25
 Setting the clock.....23
 Setting ring time
 switch26
 Setting your greeting.....24
 Turning the answering
 system on/off.....23

Setup

 Base unit5
 Handset10
 Specifications37

T

Troubleshooting.....35

U, V, W, X, Y, Z

Using your answering system
 Deleting a message29
 Playing your message27
 Recording a
 conversation30
 Remote access
 away from home31
 Remote room monitor....32
 Repeating a message.....28
 Skipping a message28
 Voice memo29

THANK YOU

FOR PURCHASING A UNIDEN PHONE!

Uniden®

Covered under one or more of the following U.S. patents:

4,511,761 4,523,058 4,595,795 4,797,916 5,381,460
5,426,690 5,431,905 5,491,745 5,533,010 5,574,727
5,650,790 5,660,269 5,661,780 5,663,981 5,671,248
5,717,321 5,754,407 5,768,345 5,787,356 5,838,721

© August 1999 Uniden America Corporation

All rights reserved • Printed in China UCZZ01646BZ