

DECT4086 Series User's Guide

What's in the box?

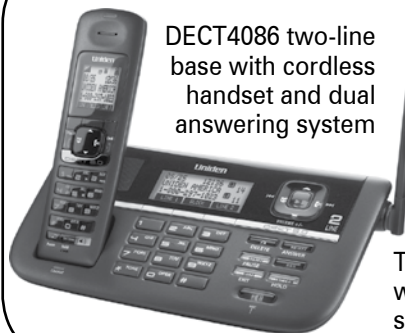

DECT4086 two-line base with cordless handset and dual answering system

Desk stand/wall mount bracket



Rechargeable battery pack (BT-1018)



Battery cover

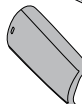

Belt clip

Base AC adapter (PS-0034)

Telephone cord with two-line support

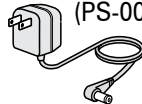

You might also find:



DCX400 accessory handset and charger

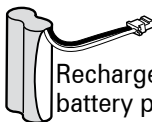

Rechargeable battery pack (BT-1018)

Battery cover



Charger AC adapter (PS-0035)



Belt clip



If you purchased model number:	You should have:
DECT4086	None
DECT4086-2	1 of each
DECT4086-3	2 of each
DECT4086-4	3 of each
DECT4086-5	4 of each
DECT4086-6	5 of each

If any items are missing or damaged, contact our Customer Care Line immediately. Never use damaged products!

Need Help? Get answers 24/7 at our website: www.uniden.com.

If You...	Contact Uniden's...	Phone Number
have a question or problem	Customer Care Line*	817-858-2929 or 800-297-1023
need a replacement part or accessory	Parts Department*	800-554-3988
need special assistance due to a disability	Accessibility Help Line	800-874-9314 (voice or TTY)

* During regular business hours, CST. Visit our website for detailed business hours.

What's in the manual?

Installing Your Phone	1	Using Multi-station Features	29
Set Up the Base.....	1	Expanding Your Phone	29
Setup the Handset(s).....	3	Using Multi-Station Conference Calling.....	29
Test the Connection.....	5	Using Privacy Mode	30
Getting to Know Your Phone	7	Using Call Transfer.....	30
Parts of the Base	7	Using the Intercom	31
Parts of the Handset.....	9	Using Special Features	32
Reading the Displays	11	Using Do Not Disturb	32
Using the Soft Keys	13	Using the Alarm Feature.....	32
Entering Text on Your Phone.....	15	Using Voice Message Notification.....	34
Using the Menus	16	Using the Answering System	35
The <i>Handset and Base Setup</i> Menu	17	Setting Up Your Answering System	35
The <i>Clock Setup</i> Menu	18	Getting Your Messages	37
The <i>Global Setup</i> Menu	18	Screening Your Calls.....	38
Special Feature Menus	19	Using the System While You're Away from Home	39
Using Your Phone	20	Solving Problems	40
Working with Two Lines.....	20	Weak or Hard To Hear Audio	42
Changing the Volume.....	22	Noise or Static On The Line	42
Using the Caller ID and Redial Lists	22	Resetting and Registering Handsets....	44
Using Seven-Digit Dialing	24	Handling Liquid Damage.....	45
Using Call Waiting	24	Important Information	46
Finding a Lost Handset	25	Terms Used In This Guide.....	46
Using an Optional Headset	25	Specifications	46
Using the Phonebook	26	Battery Information.....	46
Setting Up Your Phonebook	26	Compliance Information.....	47
Phonebook Menu Options.....	28	One-year Limited Warranty	49
Chain Dialing.....	28		

Important Safety Instructions!

When using your telephone equipment, basic safety precautions should always be followed to reduce the risk of fire, electric shock and injury to persons, including the following:

- ♦ **This unit is NOT waterproof.** DO NOT expose this unit to rain or moisture.
- ♦ Do not use this product near water, for example, near a bath tub, wash bowl, kitchen sink or laundry tub, in a wet basement or near a swimming pool.
- ♦ Avoid using a telephone (other than a cordless type) during an electrical storm. There may be a remote risk of electric shock from lightning.
- ♦ Do not use the telephone to report a gas leak in the vicinity of the leak.
- ♦ Use only the power cord and batteries indicated in this manual. Do not dispose of batteries in a fire. They may explode. Check with local codes for possible special disposal instructions.
- ♦ Do not place the handset in any charging cradle without the battery installed and the battery cover securely in place.

SAVE THESE INSTRUCTIONS!

Installing Your Phone

Set Up the Base

Attach the stand

Before you attach the stand, you have to decide if you want the phone to rest on a desk or hang on a wall.

1. For desktop use, turn the stand so the locking tabs that say **DESK** are facing the base with the arrows pointing up.

OR

For wall mount use, turn the stand so the locking tabs that say **WALL** are facing the base with the arrows pointing down.

2. Align the stand with the notches on the base.
3. Slide the stand onto the notches until it clicks into place.

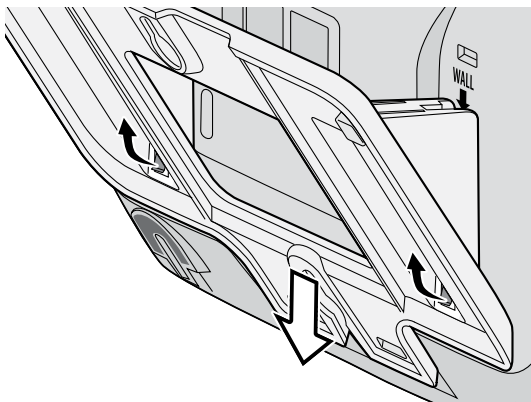
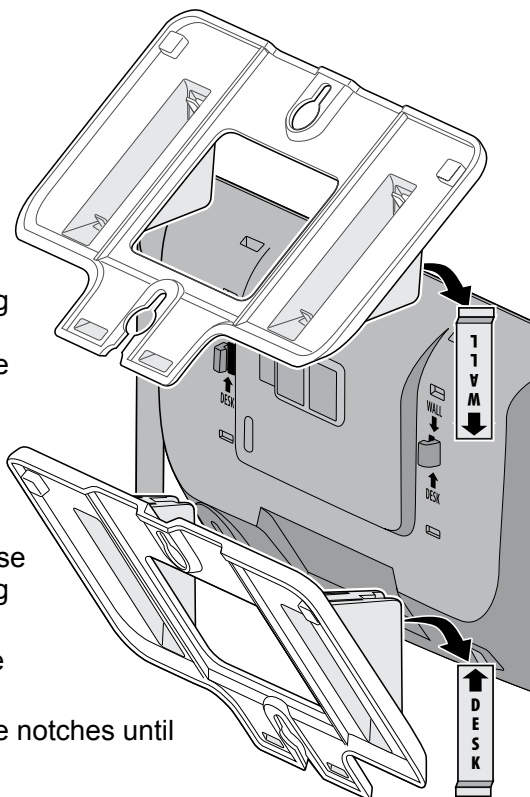

To remove the stand

Pull the locking tabs up and back (see the black arrows in the illustration to the right). Then, slide the stand straight off the same direction you put it on.

Connect the power and telephone cords

1. Connect the base AC adapter to the **AC IN 7.8V** jack and route the cord as shown:

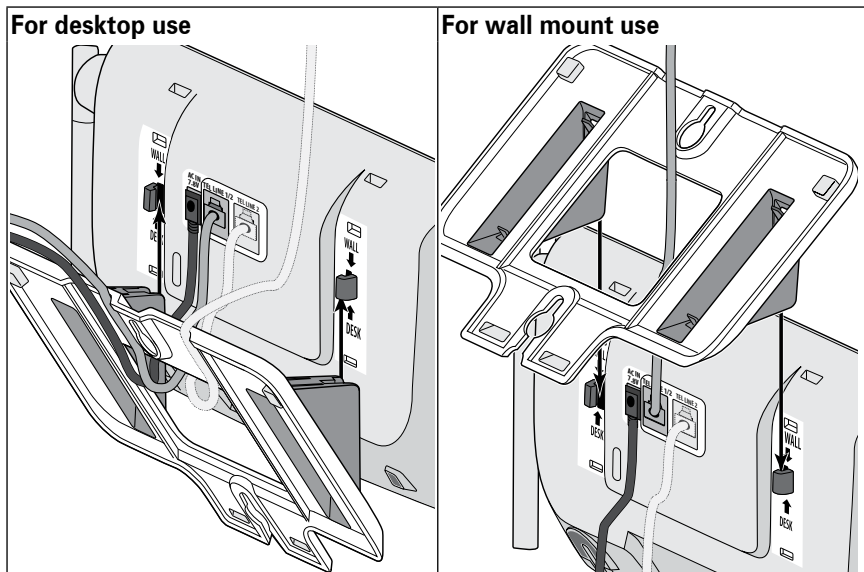

2. Connect the included two-line telephone cord to the **TEL LINE 1/2** jack. If your phone company uses a separate phone jack for each line, connect a standard telephone cord to the **TEL LINE 2** jack. Route the cords as shown above.

3. Connect the cord from **TEL LINE 1/2** to a two-line phone jack.

OR

If your phone company uses a separate phone jack for each line, connect the cord from **TEL LINE 1/2** to the jack for line 1; then, connect the cord from **TEL LINE 2** the jack for line 2.

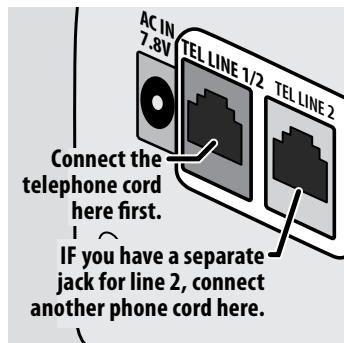

4. Plug the AC adapter into a standard 120 V AC power outlet.

Place the phone on the wall

Place the mounting slots over the pins on the wall plate, and slide the

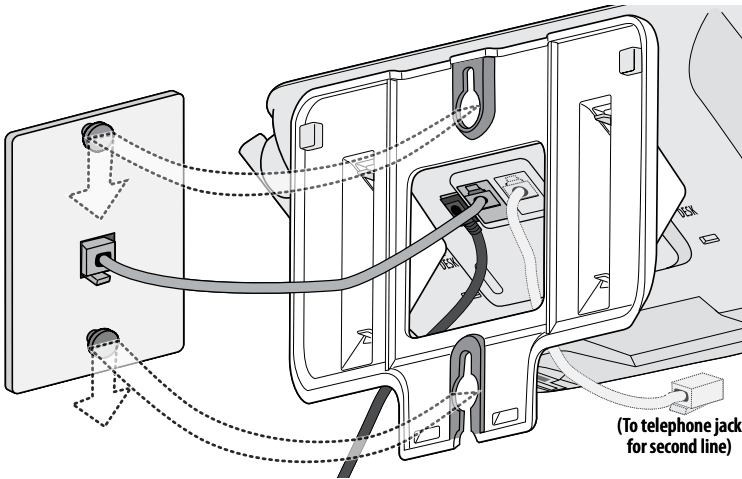

base down to lock it into place.

(To telephone jack for second line)

Setup the Handset(s)

Install the battery

1. Unpack all handsets, battery packs, and battery covers. If any handset has the battery cover already attached, press in on the notch and slide the cover down and off.
2. Line up the battery pack connector with the jack inside the handset. (The battery connector will only fit one way.)
3. Push the battery pack connector in until it clicks into place. Tug gently on the wires to make sure the battery pack is securely connected.

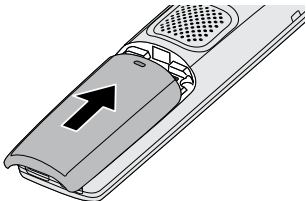
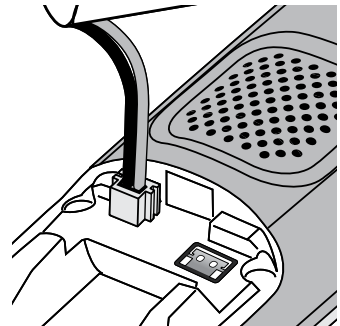
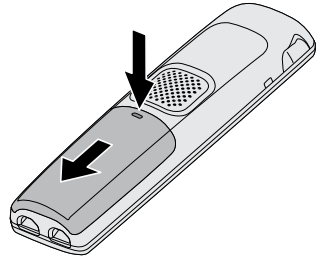

4. Place the cover over the battery compartment and slide it up into place.

Charge the battery

1. If your phone came with any accessory handsets and chargers, connect a charger AC adapter to each charger's **AC IN 8V** jack and set the plug into the notch as shown. (These adapters might already be connected.)
2. Plug the other end of the adapter into a standard 120V AC power outlet.
3. Place one handset in the base and any other handsets in a charger with the displays facing forward. (It doesn't matter which handset you place in the base.) The **CHARGE** lights on the base and all chargers should turn on.

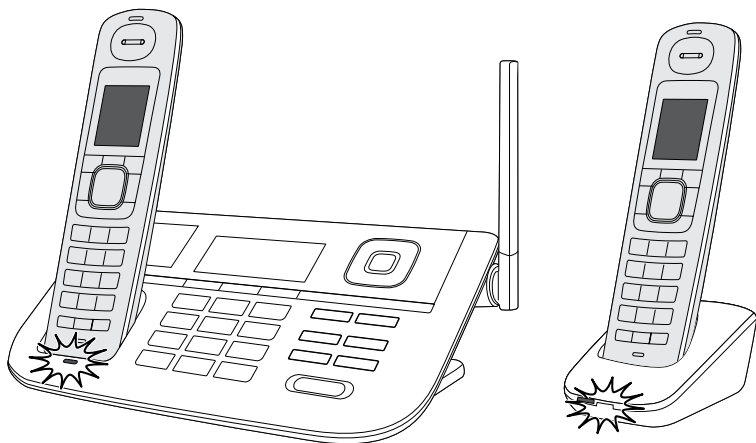
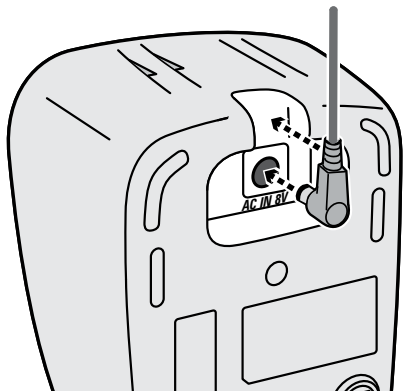

If...	Try...
a CHARGE light doesn't turn on	<ul style="list-style-type: none">- reseating the handset.- checking the AC adapter connection.- seeing if the outlet is controlled by a wall switch.

Charge all handsets completely (about 15 hours) before using them.

Test the Connection

Pick up the handset from the base and press **TALK**. The phone should pick up line 1 automatically and change the display to show *Talk* **L1**, and you should hear a dial tone.

When you get a dial tone, make a test call; press **END** to hang up.

If...	Try...
the base display says L1 <i>Check</i> or you don't hear a dial tone	checking the connection between the base and the phone jack: make sure the cord is connected to TEL LINE 1/2 .
you keep hearing a dial tone	setting line 1 to pulse dialing (see page 6).
there's a lot of noise or static	see page 42 for tips on avoiding interference.
the handset display says <i>Unavailable</i>	resetting the handset (see page 44). If you have accessory handsets, try using a different handset for the test call.

Test Line 2

Once you can make calls on line 1, make a test call on the second line. Pick up the handset and press the unmarked key under **LINE2**. You should hear a dial tone and the display should show *Talk* **L2**.



If...	Try...
the display says L2 <i>Check</i> or you don't hear a dial tone	checking the connection between the base and the phone jack: if you have a separate jack for each line, make sure the cord is connected to TEL LINE 2 .
you keep hearing a dial tone	setting line 2 to pulse dialing (see page 6).

Test any accessory handsets the same way. If you can't get a dial tone or the handset display says *Unavailable*, try moving the handset closer to the base or resetting it (see page 44).

Changing from Tone to Pulse Dialing

Phones can communicate with the telephone network in two ways: tone (DTMF) or pulse dialing. If you know your phone company uses pulse dialing or the test call for line 1 did not work, follow these steps:

1. With the phone in standby, press **MENU**.
2. Use **UP** or **DOWN** to highlight *Global Setup*, then press **OK**.
3. When your phone prompts you to select a line, press **LINE1**.
4. Use **UP** or **DOWN** to highlight *Dial Mode*, then press **OK**.
5. Highlight *Pulse*, then press **OK**. The phone sounds a confirmation tone. Try making another test call using line 1.

If your test call on line 2 did not connect, follow the same process, but press **LINE2 in step 3.**

If you use pulse dialing and you need to send DTMF tones during a call (if you're using an automated response system, for example), press ***** to temporarily switch to tone dialing. When the call ends, the phone automatically returns to pulse dialing mode.

Getting to Know Your Phone

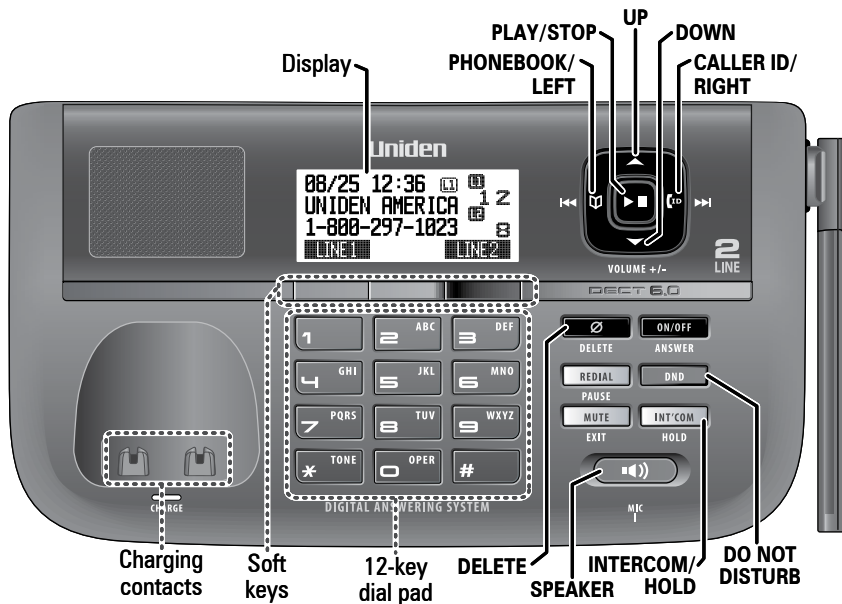

Parts of the Base

If the key name is spelled out on the key itself, it's not labeled in the drawing below.



Base keys and how they work

Key name (and icon)	What it does
PHONEBOOK/ LEFT (□/◀)	<ul style="list-style-type: none"> - In standby or during a call: open the phonebook. - During text entry: move the cursor to the left. - In the first 2 seconds of a message: go to the previous message. - Anytime after that: go to the beginning of this message.
PLAY/STOP (▶/■)	<ul style="list-style-type: none"> - In standby: start playing messages. - While a message is playing: stop playing messages.

Key name (and icon)	What it does
UP (▲)	<ul style="list-style-type: none"> - In standby: increase the ringer volume for line 1 or line 2. - During a normal call: increase the earpiece volume. - During a speakerphone call or while a message is playing: increase the speaker volume. - In the menu or any list: move the cursor up one line.
CALLER ID/ RIGHT ()	<ul style="list-style-type: none"> - In standby or during a call: open the Caller ID list. - During text entry: move the cursor to the right. - While a message is playing: skip to the next message.
DOWN (▼)	<ul style="list-style-type: none"> - In standby: decrease the ringer volume for line 1 or line 2. - During a normal call: decrease the earpiece volume. - During a speakerphone call or while a message is playing: decrease the speaker volume. - In the menu or any list: move the cursor down one line.
ON/OFF	<ul style="list-style-type: none"> - In standby: turn the answering system on or off.
DO NOT DISTURB ()	<ul style="list-style-type: none"> - In standby: turn the Do Not Disturb feature on or off (see page 32).
INTERCOM/ HOLD	<ul style="list-style-type: none"> - In standby: page a handset using the intercom. - During a call: put the call on hold and start a call transfer.
SPEAKER ()	<ul style="list-style-type: none"> - In standby: start a speakerphone call (get a dial tone). - During a normal call: switch to the speakerphone. - During a speakerphone call: hang up.
MUTE/EXIT	<ul style="list-style-type: none"> - While this station is ringing: mute the ringer for this call only. - During a call: mute the microphone. - In the menu or any list: exit the menu completely.
REDIAL/ PAUSE	<ul style="list-style-type: none"> - In standby: open the redial list. - While entering a phone number: insert a 2-second pause.
DELETE (∅)	<ul style="list-style-type: none"> - While a message is playing: delete this message. - In standby: delete all messages. - While entering text: delete one character, or press and hold to delete all the characters.
SOFT KEYS	<ul style="list-style-type: none"> - The soft keys automatically change their function based on what you are doing. See "Using the Soft Keys" on page 13.

Parts of the Handset

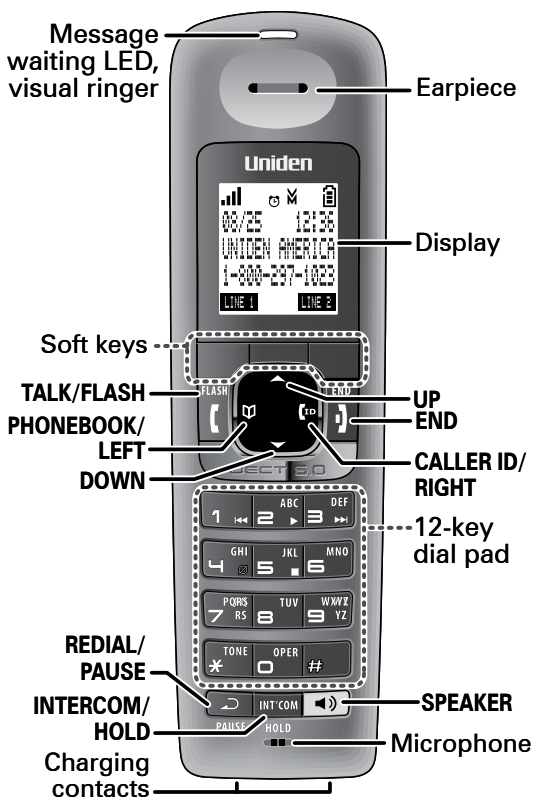

Handset keys and how they work

Key name (and icon)	What it does
UP (▲)	<ul style="list-style-type: none"> - In standby: increase the ringer volume for line 1 or line 2. - During a call: increase the call volume. - In the menu or any list: move the cursor up one line.
END	<ul style="list-style-type: none"> - During a call: hang up. - In the menu or any list: exit and go to standby.

Key name (and icon)	What it does
CALLER ID/ RIGHT (ID)	<ul style="list-style-type: none"> - In standby or during a call: open the Caller ID list. - During text entry: move the cursor to the right.
SPEAKER (🔊)	<ul style="list-style-type: none"> - Switch a normal call to the speakerphone (and back).
INTERCOM/ HOLD	<ul style="list-style-type: none"> - In standby: page another station using the intercom. - During a call: put the call on hold and start a call transfer.
REDIAL/ PAUSE (↶)	<ul style="list-style-type: none"> - In standby: open the redial list. - While entering a phone number: insert a 2-second pause.
DOWN (▼)	<ul style="list-style-type: none"> - In standby: decrease the ringer volume for line 1 or line 2. - During a call: decrease the call volume. - In the menu or any list: move the cursor down one line.
PHONEBOOK/ LEFT (◀)	<ul style="list-style-type: none"> - In standby or during a call: open the phonebook. - During text entry: move the cursor to the left.
TALK/FLASH	<ul style="list-style-type: none"> - In standby: start a telephone call (get a dial tone). - During a call: switch to a waiting call.
SOFT KEYS	<ul style="list-style-type: none"> - The soft keys automatically change their function based on what you are doing. See "Using the Soft Keys" on page 13.

Reading the Displays

On the base

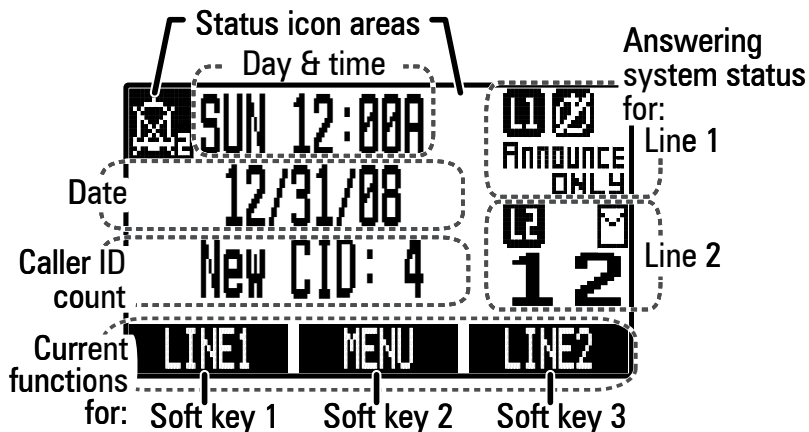



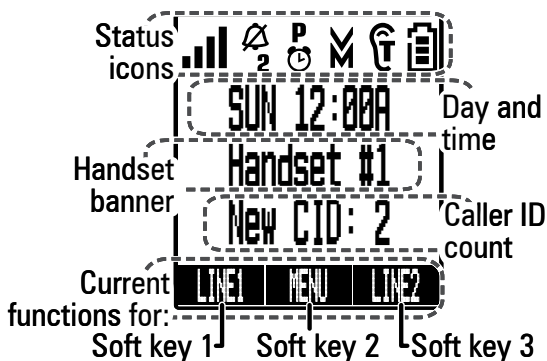





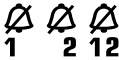



On the handset



The table below shows the possible icons and what they mean. Since the icons appear based on what you're doing with the phone, you won't ever see all of these icons at the same time.

Base Icon	Handset Icon	What it means
L1 or L1	L1	The accompanying information (in use, on hold, etc.) applies to line 1.
L2 or L2	L2	The accompanying information (in use, on hold, etc.) applies to line 2.

Base Icon	Handset Icon	What it means
		The ringer is turned off for 1) line 1 only, 2) line 2 only, or 3) both. This station will not ring when a call comes in on the indicated lines.
		You have a voice message waiting (see "Using Voice Message Notification" on page 34).
		Privacy Mode is on: no other station can join your call.
		The speakerphone is on.
		The microphone is muted, and the caller can't hear you.
NA		The alarm is set. (See "Using the Alarm Feature" on page 32.)
NA		T-coil mode is on. (See "Do you use a T-coil hearing aid?" on page 43.)
NA		The battery is 1) fully charged, 2) half charged, 3) getting low, or 4) empty.
NA		The signal from the base is 1) very weak, 2) low, 3) strong, or 4) very strong.

Answering system status icons

The icons on the right hand side of the base display indicate the status of the answering system. Each icon will appear separately for line 1 (at the top) and line 2 (at the bottom). See *Using Your Answering System* on page 35 for more information.

Icon	What it means
	The answering system is off: it will not answer the phone.
Announce ONLY	The answering system is set to announce only: it will answer the phone but will not record any messages.
FULL	The answering system memory is full: you must delete some saved messages.
01 through 59	This number indicates the number of new messages for each line.

Using the Soft Keys

Soft keys are controlled by the software: they will automatically change their function depending on what you're currently doing:

Soft keys with the phone in standby

On the base

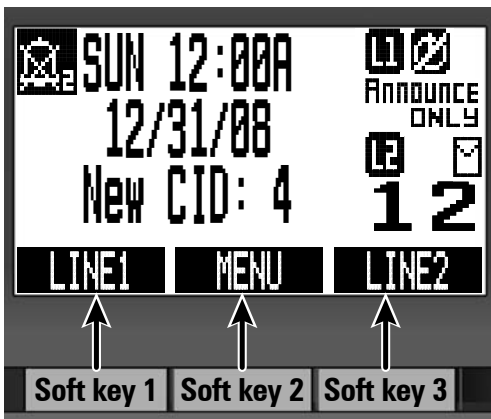

On the handset

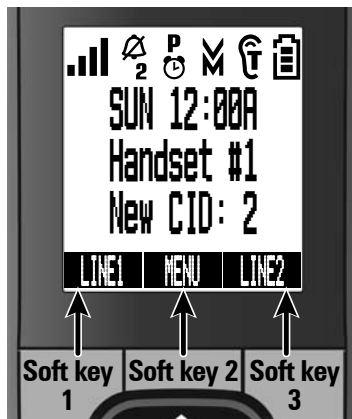

Soft keys in the main menu

On the base

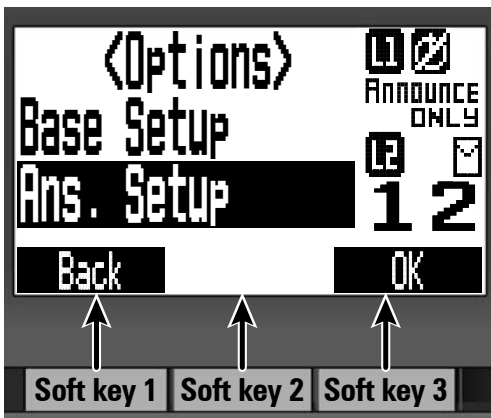

On the handset

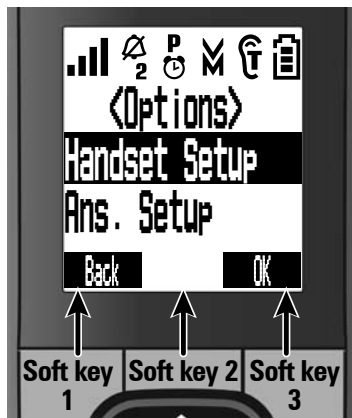

- ◆ The description of the soft key's current function appears in the bottom of the display directly above the corresponding key.

- ◆ If the description for a soft key is blank, that key doesn't currently have a function.
- ◆ Sometimes, the current function of a soft key can duplicate the function of a regular key. If this happens, you can press either key.
- ◆ When this manual refers to a soft key, it uses the soft key's description printed on a black background.

Common soft key descriptions

The table below lists some soft key descriptions that the phone uses across several menus or operations. These are not all the soft key descriptions, but these are probably the ones you'll see most often.

Soft key description:	What it does:
BACK	Go back to the previous screen. Any unsaved changes on the current screen will be canceled.
CANCEL	Cancel the current operation without saving any changes.
DELETE	Erase the highlighted item.
LINE1	Use line 1 for the current operation.
LINE2	Use line 2 for the current operation.
MENU	Open the main menu screen.
MUTE	Turn off the ringer, speaker, or microphone.
OK	Select the highlighted option or confirm the current operation.
OPTIONS	Show available choices for the current operation or for the highlighted item.
SELECT	Choose the highlighted option.

Entering Text on Your Phone

When you want to enter text into your phone (for example, a name in the phonebook), use the twelve-key dial pad to enter the letters printed on the number keys. Here's how it works:

- ◆ The phone enters the letters in the order they appear on the key. For example, if you press the number key **2** once, the phone enters the letter **A**. Press **2** twice for **B**, and three times for **C**.
- ◆ If you press the key again after the last letter, the phone starts the same letter sequence with small letters. If you press **2** four times in a row, the phone enters **a** (small letter). Press **2** five times for **b**, and six times for **c**.
- ◆ If you see the icon **[Aa]** in the display, the phone enters capital letters first (**A B C**), then small letters (**a b c**), then the number on the key (**2**). The icon **[aA]** means the phone starts at the small letters, so it enters small letters first, then the number on the key, then capital letters.
- ◆ The phone automatically uses a capital letter for the first letter and any letter right after a space; all other times, it uses small letters.
- ◆ If two letters in a row use the same number key, enter the first letter, then use **CALLER ID/RIGHT** to move the cursor to the next position to enter the second letter.

Switch between capital and small letters	Press * .
Move the cursor	Press PHONEBOOK/LEFT to move the cursor to the left or CALLER ID/RIGHT to move the cursor to the right.
Leave a blank space	Press # (POUND) .
Erase one letter	Move the cursor to the letter you want to erase and press the DELETE soft key. (On the base, you can also press DELETE .)
Erase the entire entry	Press and hold DELETE .
Enter punctuation or a symbol	Press 0 to rotate through the available symbols.

Using the Menus

The menus are designed to be as easy as possible. Some users don't even need the manual once they know how to perform these actions:

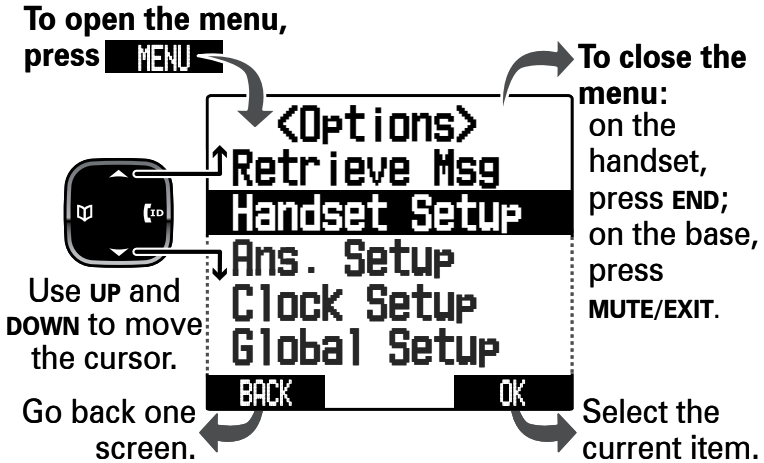

If you don't press any keys for thirty seconds, the phone times out and exits the menu. (When setting the day and time, the time-out period is extended to two minutes.)

Open the menu	Press MENU .
Move the cursor	<ul style="list-style-type: none"> - The cursor (the black bar with the white text) shows which menu item is currently highlighted; when you're entering characters, the cursor shows where you are in the line. - Use UP to move the cursor up one line. - Use DOWN to move it down one line. - Use PHONEBOOK/LEFT to move it one space to the left. - Use CALLER ID/RIGHT to move it one space to the right.
Select an option	Move the cursor to highlight the option, then press OK .
Return to the previous screen	Press BACK . If you press BACK on the first screen, the phone exits the menu.

Close the menu	On the handset, press END ; on the base, press MUTE/EXIT . (If you open the menu during a call, press BACK to back out of the menu without hanging up.)
----------------	---

The next several pages list all the available menu options and how to use them. Most of the menus are the same for the base and cordless handsets; any option that is available only for the base or handset is noted in the description.

The Handset and Base Setup Menu

When you open the menu on a handset, this menu is called *Handset Setup*. On the base, this menu is called *Base Setup*. Each of these options can be set separately for each station. (A station can be any cordless handset or the base.)

Menu option:	Use it to:
<i>T-coil</i>	(Handset only) Turn on T-coil mode to reduce noise on some hearing aids (see "Do you use a T-coil hearing aid?" on page 43).
<i>Alarm Setting</i>	(Handset only) Set alarms on your handset (see "Using the Alarm Feature" on page 32).
<i>Primary Line</i>	Select the line you want this station to use as the default line when you make a call (see "Assigning a primary line" on page 20).
<i>Ringer Tones</i>	(Handset only) See the ring tones the handset is using as the main ring tone for each line. To change the tone, select the line, then choose a ring tone from the list. (As you highlight each ring tone, the phone plays a sample of the tone. When you hear the tone you want, press OK .)
<i>Personal Ring</i>	(Handset only) Turn on the personal ring feature. If you have Caller ID, this feature lets you assign special ring tones to anyone in your phonebook: this handset will use the special ring tone when that person calls.

Menu option:	Use it to:
<i>Autotalk</i>	(Handset only) Turn on Auto Talk so you can answer the phone just by picking up the handset from the cradle (without having to press any buttons).
<i>Any Key Answer</i>	(Handset only) Turn on Any Key Answer so you can answer the phone by pressing a key on the twelve-key dial pad.
<i>Banner</i>	(Handset only) Change the name used on the handset's display. Enter any name up to 10 characters.
<i>Handset/Base Language</i>	Change the language used in the display.
<i>LCD Contrast</i>	Change the contrast of the display.
<i>Key Touch Tone</i>	Have the keypad sound a tone when you press a key.

The Clock Setup Menu

You must set the date and time if you want to use the handset's alarm feature; setting the clock will also ensure the answering system stamps your messages with the correct time and day. You can set the clock from the base or any cordless handset.

1. Open the menu and select *Clock Setup*.
2. Use the numbers on the twelve-key dial pad to enter the date.
3. Move the cursor to the next line, then use the dial pad to enter the time.
4. Press **★** to switch between *AM* and *PM*; when you're finished, press **SAVE**.

The Global Setup Menu

The settings on this menu are separate for each line: changing the settings for line 1 will not affect line 2, and vice versa. However, the settings for each line apply to all stations whenever they use that line.

Before changing these settings, make sure the phone is in standby and all handsets are within range of the base. (Only one station at a time can change these settings.)

When you select the *Global Setup* menu, the phone prompts you to select *Line 1* or *Line 2*. Then, you can choose one of the following options to change the global settings for that line:

Menu option:	Use it to:
<i>Area Code</i>	Enter your area code so the phone hides the area code on incoming local calls (see "Using Seven-digit Dialing" on page 24).
<i>Dial Mode</i>	Change the way your phone communicates with the telephone network (see "Changing from Tone to Pulse Dialing" on page 6).
<i>Set Line Mode</i>	Do not change this setting unless instructed to by customer service.
<i>VMWI Reset</i>	(Base only) Reset the voice message waiting indicator to bring it back into sync with your voice mail service (see "Using Voice Message Notification" on page 34).

Special Feature Menus

The following menus control specific features of your phone. These menus are explained under the section that describes the feature in detail:

Menu:	Use it to:	For details, see:
<i>Retrieve Msg</i> (handset only)	Access your answering system from a cordless handset	"Getting Your Messages" on page 37
<i>Ans. Setup</i>	Change the settings for the answering system on each line.	" <i>Ans. Setup</i> menu options" on page 36
<i>Register Handset</i> (base only)	Add new handsets or reset a handset that isn't working properly.	"Resetting and registering handsets" on page 44

Using Your Phone

Working with Two Lines

When performing common tasks, you can let the station use the primary line, or you can manually choose a particular line for each task. Using the primary line makes common tasks much simpler, but you will need to assign a primary line to each station (see below).

If you want to...	From a handset	From a handset speakerphone	From the base speakerphone
make a call: Dial the number, then			
- with the primary line	Press TALK/FLASH .	Press SPEAKER .	
- by choosing a line	Press LINE1 or LINE2 .*		
answer a call			
When a call comes in, the soft keys blink to tell you which line is ringing.			
- with the primary line	Press TALK/FLASH .	Press SPEAKER .	
- by choosing a line	Press the soft key for the line you want to answer.*		
hang up	Press END or return the handset to the cradle.		Press SPEAKER .
switch between the speaker and earpiece	Press SPEAKER .		Not available
put a call on hold	Press INTERCOM/HOLD ; the soft key blinks to remind you the line is on hold. To return to the call, press the soft key (LINE1 or LINE2) for the holding line.		
switch lines during a call (automatic hold)	Press the soft key for the other line; the current call is automatically put on hold (see above). To return to the call, press the soft key for the holding line.		
mute the microphone during a call	Press MUTE . Press again to turn the microphone back on.		Press MUTE/EXIT .
mute the ringer for this call only	While the phone is ringing, press END .		press MUTE/EXIT .

* On the handset, press **SPEAKER** to switch to the speakerphone.

Assigning a primary line

You can assign a primary line to each station; the station connects to its primary line whenever it goes off hook (that is, when you press **TALK/FLASH** or **SPEAKER**). Whenever you want, you can bypass the

primary line assignment by manually choosing line for your current task.

To assign a primary line, open the menu and select *Handset Setup* or *Base Setup*. Select *Primary Line*, then choose the line you want this station to connect to when it goes off hook:

<i>Line 1</i>	Always connect to line 1, regardless of either line's status.
<i>Line 2</i>	Always connect to line 2, regardless of either line's status.
<i>Auto</i> (default setting)	Connect to line 1 except under the following circumstances: - there is an incoming call on line 2 - there is a holding call on line 2 - the answering system has picked up line 2 - line 1 is being used for an active call or for screening a call If any one of these conditions is true, the station connects to line 2.

Conferencing two lines together

When you have active calls on both lines, you can join the two lines together in a conference call.

1. Place the first call on hold.
 2. Switch to the other line and start the second call.
 3. Press **MENU**, then select *Conference*.
- ◆ During a conference call, you can speak with both outside callers at the same time, and the callers can speak with each other.
 - ◆ To separate the conference call back into two independent calls, press the soft key for either line. The other line is automatically put on hold, and you can switch between calls normally.
 - ◆ To disconnect both callers at the same time, just hang up normally.
 - ◆ To disconnect one caller at a time, select the line you want to disconnect, then hang up. Press the soft key to return to the other caller (on hold).

Other stations can also join in the conference call. See *Using Multi-station Features* on page 29 for more information.

Changing the Volume

You can set the volume of the ringer and speaker separately for the base and each handset; you can also set the earpiece volume on each handset. The available volume levels and how to change them are listed below; for each item, press **UP** to make it louder or **DOWN** to make it softer.

Change the	When	On the base	On a handset
ringer volume	the phone is in standby	select a line, then select <i>Off, Low, Medium, or High</i>	
earpiece volume	you are on a normal call	Not available	choose one of 6 volume levels for the active line
speaker volume	you use the speaker-phone for a call or getting messages	choose one of 10 volume levels for the active line	choose one of 6 volume levels for the active line

Using the Caller ID and Redial Lists

You have to subscribe to Caller ID to use Caller ID features: contact your telephone provider for more information.

Caller ID list information	Redial list information
<ul style="list-style-type: none">- When a call comes in, the phone displays the caller's number and name (if available) along with which line is receiving the call.- The phone saves the information for the last 50 calls received on either line to the <i>CID list</i>. The phone records which line the call came in on.- When it's in standby, each station displays the total number of calls received on both lines since the last time you checked the CID list.- You can edit the list separately on each station.	<ul style="list-style-type: none">- Each station has its own redial list.- The redial list contains the last 10 phone numbers dialed from that station.- The redial list does not record which line was used to dial the number.

Using the lists

Open the CID list	Press CALLER ID/RIGHT .
Open the redial list	Press REDIAL/PAUSE .
Scroll through the CID or redial list	Press DOWN to scroll through the list from newest to oldest. Press UP to scroll from oldest to newest.
Close the CID or redial list	Press END on a handset or MUTE/EXIT on the base. (If you open the CID list during a call, press BACK to back out of the list without hanging up.)

Dialing from the CID or redial list

1. Find the entry you want to dial.
2. If the phone number is a toll or long distance call, but there's no **1** at the front of the record, press ***** to add the **1**.
3. To dial the entry with the primary line for this station, press **TALK/FLASH** or **SPEAKER**; to manually choose a line, press **LINE1/LINE2** to dial the entry.

You can also go off hook before you open the list. Press **TALK/FLASH** or **SPEAKER** (for the primary line) or press **LINE1/LINE2**. Find the entry you want, then press **DIAL**.

Caller ID and redial menu options

Open the CID or the redial list. Find the entry you want and press **OPTIONS**. Choose one of the following:

<i>Store into PB</i>	Add the selected CID/redial list entry to this station's phonebook. The phone creates a new phonebook entry, then prompts you to edit the name and phone number; cordless handsets also prompt you to choose a personal ring (see page 26).
<i>Store & Edit</i>	Append the selected phone number to an existing phonebook entry. The phone prompts you to select the phonebook entry you want to add the number to, then opens that entry for editing (see page 27).

<i>Delete Entry</i>	Erase this entry from the CID or redial list.
<i>Delete All</i>	Erase all entries from this station's CID or redial list. (This doesn't affect the CID or redial lists on any other stations.)

Using Seven-Digit Dialing

If you can make a local call by dialing only seven digits instead of ten, you can tell the phone to hide your local area code in the CID list.

Do not enter an area code if your phone company requires ten-digit dialing. You might not be able to dial from the CID list.

1. With the phone in standby, open the menu and select *Global Setup*.
2. Press **LINE1** or **LINE2**, then select *Area Code*.
3. Use the number keypad (**0 - 9**) to enter a three-digit area code.
4. Press **OK** when you're finished.
 - ◆ The phone uses the programmed code as a filter. When calls come in, the phone compares the incoming area code to the one programmed for that line. If they match, the phone hides the area code in the CID list.
 - ◆ While reviewing the list, press **#** to toggle the area code off and on.
 - ◆ When you dial from the CID list or save the number to the phonebook, the phone dials or stores the number exactly as it is currently displayed.

Using Call Waiting

- ◆ A Call Waiting call refers to a call received on a line while that line is already in use.
- ◆ Call Waiting and Caller ID on Call Waiting are services provided by your telephone company. You must subscribe to these services to use these features.
- ◆ Call Waiting is independent for each line: Call Waiting calls do not roll over to the second line.

- ◆ When you get a Call Waiting call, the phone sounds a tone and displays any CID information received for the waiting call.
- ◆ To answer a Call Waiting call, press **FLASH** on the base or **TALK/FLASH** on a handset. The phone company automatically puts the current call on hold and switches you to the waiting call.
- ◆ Use **FLASH** and **TALK/FLASH** to switch between the two calls; remember, each time you switch, there is a short pause before you're connected to the other caller.

Finding a Lost Handset

With the phone in standby, press **INTERCOM/HOLD** on the base. Select the handset you want to find, or select *All* to page all handsets at the same time. The paged handset(s) will beep for 1 minute or until you press **INTERCOM/HOLD** again or press **TALK/FLASH** followed by **END** on the handset.

Using an Optional Headset

You can use a standard 2.5 mm telephone headset with your cordless handsets. To purchase headsets, contact the Parts Department (see the front cover).

- ◆ To install a headset, remove the headset jack cover and insert the headset plug into the jack.
- ◆ Just make and receive calls as usual, and use your headset to talk to the caller after the call connects.
- ◆ When you connect a headset, the handset automatically mutes the earpiece and speaker. To re-activate the earpiece or speaker, just unplug the headset.

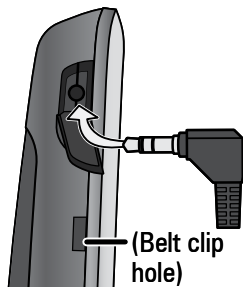

Using the Phonebook

Each station can store up to 100 entries in its phonebook, and each entry can have two different phone numbers.

Open the phonebook	Press PHONEBOOK/LEFT .
Scroll through the entries	Press DOWN to scroll through the phonebook from A to Z or UP to scroll from Z to A.
Jump to entries that start with a certain letter	Press the number key corresponding to the letter you want to jump to.
Quick dial the primary number for an entry	<ol style="list-style-type: none">1. Find the entry you want to dial.2. To dial with the primary line for this station, press TALK/FLASH or SPEAKER; to manually choose a line, press LINE1/LINE2. The phone automatically dials the number in the first phone number slot.
Dial either number for an entry	<ol style="list-style-type: none">1. Find the entry you want to dial and press SELECT.2. Select one of the two phone numbers for that entry.3. To dial the number with the primary line for this station, press TALK/FLASH or SPEAKER; to manually choose a line, press LINE1/LINE2.
Use a speed dial number to open a phonebook entry	On the dial pad, press and hold the number assigned to the phonebook entry you want. The phone opens the phonebook and goes directly to that entry. Follow the instructions for dialing an entry above.
Close the phonebook	On the handset, press END ; on the base, press MUTE/EXIT . (If you open the phonebook during a call, press BACK to back out without hanging up.)

Setting Up Your Phonebook

Creating a new entry

Open the phonebook with the phone in standby, and press **NEW**. The phone walks you through the phonebook entry items in the order listed below. On each screen, press **OK** when you're finished editing the item or if you want to skip the item:

<i>Edit Name</i>	Enter the name (up to 16 characters) you want to use for this entry.
------------------	--

<i>Edit Number1</i>	Enter the primary number (up to 32 digits) for this entry exactly the way you would dial it. - If you need the phone to wait before sending the next set of digits, press REDIAL/PAUSE to enter a two-second pause. - If two seconds isn't long enough, you can enter as many pauses as you want. - Each pause counts as one digit (you'll see a <i>P</i> in the number).
<i>Edit Number2</i>	Enter the secondary number for this entry just like you did the primary number.
<i>Personal Ring selection</i>	(Handset only) Choose the ring tone you want the handset to use when this person calls. As you highlight each ring tone, the handset sounds a sample of that tone.
<i>Speed Dial</i>	Select the speed dial number (<i>SPD0</i> through <i>SPD9</i>) you want to assign to this entry. - The speed dial numbers correspond to the numbers (0 through 9) on the twelve key dial pad. - Each speed dial number can be assigned to only one entry. - If the speed dial number is already assigned, the phone shows the name of the entry assigned to the number. If you want to change it, select the number, and the phone overwrites the existing assignment.

Editing an existing entry

1. With the station in standby, open the phonebook and find the entry you want.

2. Press **OPTIONS**, then choose *Edit*.

3. Highlight the individual item you want to change and press **SELECT**. The phone goes to the edit screen for that item.

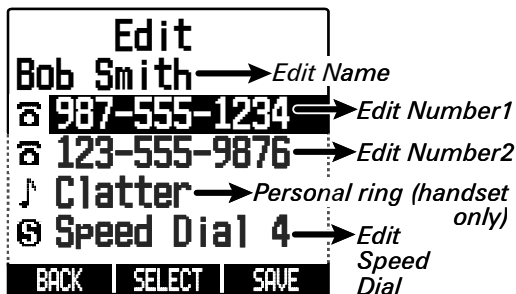

4. Edit the item as described under "Creating a new entry" (above), and press **OK**. OR press **BACK** to cancel editing and return to the main entry.
5. Highlight the next item you want to edit and press **SELECT**. If you're finished editing this entry, press **SAVE**.

Phonebook Menu Options

Open the phonebook with the phone in standby, and press **OPTIONS** to open the phonebook menu. From the main phonebook screen, you have two options:

<i>Copy All</i>	Copy the whole phonebook to another station. (You must have at least one cordless handset to use this multi-station feature.)
<i>Delete All</i>	Erase all the entries in this station's phonebook. (This does not affect the entries saved on any other stations.)

If you select an individual entry and then press **OPTIONS**, you have these additional options:

<i>Create New</i>	Add an entry to your phonebook. (See "Creating a new entry" on page 26.)
<i>Copy</i>	Copy this entry to another station. (You must have at least one accessory handset to use this multi-station feature.)
<i>Edit</i>	Edit this entry. (See "Editing an existing entry" on page 27.)
<i>Delete</i>	Erase this entry.

Chain Dialing

- ◆ If you often have to enter a series of digits or a code number during a call, you can save that code number to a phonebook entry and use the phonebook to send the code number.
- ◆ Enter the code number (up to 32 digits) into the phonebook just like a regular phonebook entry. Be sure to enter the code number into the phonebook exactly as you would enter it during a call.

During your call, when you hear the prompt to enter the code number:

1. Open the phonebook and find the entry that contains your code number.
2. Press **SELECT** and select the number (phone number 1 or 2) you want.
3. Press **DIAL** to transmit the code. The phone transmits the code number exactly as you entered it in the phonebook.
OR if you change your mind, use **BACK** to close the phonebook.

Using Multi-station Features

The expandable base works together with the accessory handsets to give you some useful multi-station features. (A station can be any cordless handset or the base.) You must have at least one accessory handset to use the features in this section.

Expanding Your Phone

- ◆ Your base supports a total of ten DCX400 accessory handsets, including any that were supplied with your phone.
- ◆ Your base might be compatible with other Uniden accessory handsets: please visit our website for a list of compatible handsets.
- ◆ Accessory handsets must be registered to the base before you can use them. Handsets that aren't registered display a *Handset not registered* message. For instructions on registering handsets to this base, see page 44 or refer to the manual that came with the accessory handset.
- ◆ Any accessory handsets that came packaged with the base are already registered to that base for you.
- ◆ If a handset was previously registered to a base, you have to reset it so you can register it to a new base (see page 44 for DCX400 handsets).

Using Multi-Station Conference Calling

- ◆ When an outside call comes in on either line, the base and four cordless handsets can join in a six-way conference call with the outside caller.
- ◆ To join a call in progress, just connect to the active line (press **LINE1** or **LINE2**).

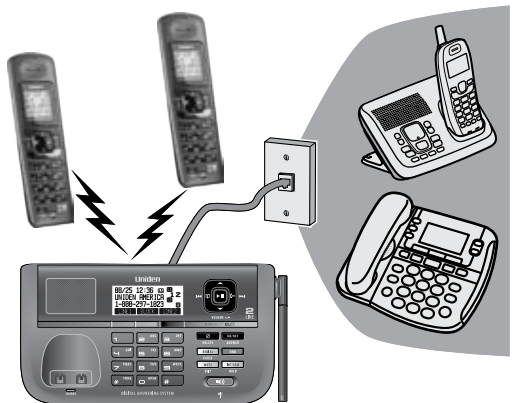

- ◆ To leave a conference call, hang up normally; all other stations remains connected to the call.
- ◆ If you conference line 1 and line 2 together (see page 21), the base and four cordless handsets can hold a seven-way call with both outside callers at the same time.
- ◆ You can also use the speakerphone for a conference call, just like you can with a normal call.

Using Privacy Mode

You can prevent other stations from joining a call. Start your call as usual, then press **MENU** and select *Call Privacy*. When you hang up, privacy mode turns off automatically.

As long you have privacy mode on, no other stations can interrupt your call (you'll see a **P** in the handset display and a  in the base display). To allow another station to join the call, just turn privacy mode off by repeating the process above (press **MENU** and select *Call Privacy*).

Using Call Transfer

To...	From the base	From a handset
transfer a call	1. Press INTERCOM/HOLD to put the call on hold. 2. Select the station you want to transfer the call to, or select <i>All</i> to page all the stations at the same time. When the other station accepts the call, you'll be disconnected, but you can join the call again.	
cancel a transfer	Press SPEAKER to return to the call.	Press TALK/FLASH to return to the call.
accept a transferred call	1. To answer the page and speak to the transferring station, press INTERCOM/HOLD . 2. To accept the call, press the soft key (LINE1 or LINE2) for the holding line.	

Using the Intercom

Here are some things you need to know about using the intercom:

- ◆ Whenever the phone is in standby, you can make an intercom call between stations without using the phone line.
- ◆ You can make an intercom call from any station, but only two stations can be in an intercom call at any time.
- ◆ If an outside call comes in during an intercom call, the phone shows the CID information. If the other station hasn't answered the page, the phone cancels the page so you can answer the incoming call.

To...	From the base	From a handset
make an intercom page	1. Press INTERCOM/HOLD . 2. Select the station you want to talk with, or select <i>A//</i> to page all the stations at the same time.	
cancel a page	Press INTERCOM/HOLD .	Press END .
answer an intercom page	Press INTERCOM/HOLD .	Press INTERCOM/HOLD or TALK/FLASH .
leave an intercom call	Press INTERCOM/HOLD .	Press END .
answer an outside call during an intercom call	Press the soft key (LINE1 or LINE2) for the line you want to answer. The phone automatically disconnects the intercom call and connects you to the outside line.	

Using Special Features

Using Do Not Disturb

- ◆ The *Do Not Disturb* or *DND* feature turns off the ringers of the base and all handsets at the same time.
- ◆ With the phone in standby, press and hold **DO NOT DISTURB** on the base. The phone automatically turns on the answering system and shows *Do Not Disturb* in the display on all stations.
- ◆ To cancel, press **DO NOT DISTURB** again.

If you turn the answering system off while DND is on, the phone turns off DND along with the answering system.

Using the Alarm Feature

You can set 3 different alarms on each cordless handset so your phone can remind you of important events. When an alarm is set, the alarm icon (🕒) appears on the top of the screen.

Setting an alarm

1. Open the menu and select *Handset Setup*.
2. Select *Alarm Setting*, then select the alarm (*Alarm1*, *Alarm2*, or *Alarm3*) you want to set.
3. To turn on the alarm, select *On*. The phone goes to the alarm edit screen.



4. Highlight the time setting and press **SELECT**.

5. Use the number keys to set the time you want the alarm to ring; press **OK** when you're finished.
6. Highlight the repeat setting and press **SELECT**. Select how often you want the alarm to ring—once only (*1 time*), every day (*Daily*), or on a weekly basis (*Select Days*)—then press **OK**.
7. If you choose *Select Days*, the handset prompts you to choose which days of the week the alarm should ring. To choose a day, highlight it and press **SELECT**; a check mark appears beside that to show that it is selected. Select as many days as you want, then press **OK**. The alarm will ring on each day with a check mark beside it.
8. Highlight the ringer setting and press **SELECT**.
9. Select the ring tone you want the alarm to use, then press **OK**.
10. When you are finished setting all the alarm options, press **SET** to activate the alarm. The time and repeat setting will show on the main *Alarm Setting* screen. (If you selected specific days, the repeat setting displays as *Weekly*.)

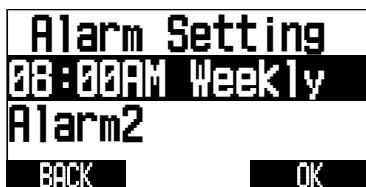

When an alarm rings

When the day and time on the phone matches the day and time of an alarm setting, the handset sounds the selected tone and displays the alarm screen.



- ◆ The alarm will ring for one minute. To turn off the alarm, press **END**. When the phone prompts you to confirm, press **YES**.
- ◆ To temporarily turn off the alarm, press **SNOOZE** (or just let the alarm ring for the full minute). The alarm will ring again in five minutes.
- ◆ To cancel snooze, press **END** the next time the alarm rings. When the phone prompts you to confirm, press **YES**.

Using Voice Message Notification

This feature supports Frequency-Shift Keying (FSK) message notification. Contact your voice mail provider for more details.

If you subscribe to a voice mail service, your phone can notify you when you have a new message waiting on either line. When you have new messages, the voice message icon (M) appears in the display, and the new message light (at the top of the handset) blinks.

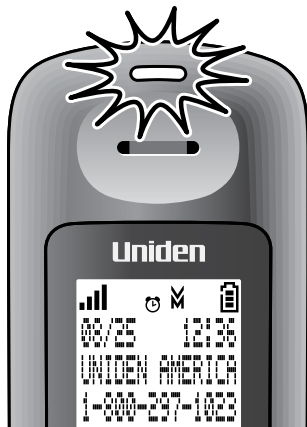

Resetting the voice message indicator

If the voice message icon remains after you check your messages, you can reset it from the base:

1. Open the menu and select *Global Setup*.
2. When the phone prompts you to select a line, press **LINE1** or **LINE2**.
3. Select *VMWI Reset*, then select *Yes* to reset the indicator.

Using the Answering System

Each line has a separate answering system. Whenever you access the answering system, the phone prompts you to choose a line. After that, any settings or operations will affect only the answering system for that line. For example, deleting all the messages from the answering system from line 1 does not affect any messages on the answering system for line 2.

Setting Up Your Answering System

Recording your outgoing message

Your personal outgoing message or greeting can be between 2 seconds and 30 seconds long. If you don't want to record an outgoing message, the system will use its pre-recorded greeting:

Hello, no one is available to take your call. Please leave a message after the tone.

To record your greeting:

1. Open the menu and select *Ans. Setup*.
2. Select *Line 1* or *Line 2*, then select *Record Greeting*.
3. Press **START**. Wait for the system to say "Record greeting" and then begin your recording.
4. When you're finished, press **STOP**. The system plays back your new greeting.
5. To keep this greeting, press **STOP** again. To delete it and try again, press **DELETE**.

Switch between the pre-recorded greeting and your greeting

1. Open the menu and select *Ans. Setup*.
2. Select *Line 1* or *Line 2*, then select *Greeting Options*.
3. The system plays back the current greeting (personal or pre-recorded) for this line. Press **CHANGE** to switch greetings or **STOP** to keep the current greeting.

Delete your greeting

1. Open the menu and select *Ans. Setup*.
2. Select *Line 1* or *Line 2*, then select *Greeting Options*.
3. While the system plays back the current greeting, press **DELETE** to erase the personal greeting for this line. (You can't erase the pre-recorded greeting.)

Ans. Setup menu options

You can change the answering system options separately for each line. When you select the *Ans. Setup* menu, the phone prompts you to select *Line 1* or *Line 2*. Then, you can choose one of the following options to change the answering system settings for that line:





<i>Security Code</i>	Enter a 2-digit PIN so you can access your answering system from any touch-tone phone (see page 39).
<i>Ring Time</i>	Set the number of rings (2, 4, or 6) before the answering system answers the phone. Choose <i>Toll Saver (TS)</i> to have the system pick up after 2 rings if you have new messages or after 4 rings if you don't.
<i>Record Time</i>	Set the amount of time callers have to leave a message, either 1 minute or 4 minutes. Choose <i>Announce Only</i> if you don't want the system to let callers to leave a message.
<i>Message Alert</i>	Have the system beep every 15 seconds when you have a new message; the beeping stops when you listen to all your new messages. (To mute the alert without listening to your messages, press any key on the base.)
<i>Ans. Language</i>	Change the language of the system's voice prompts.
<i>Call Screen</i>	Turn on the call screen feature so you can hear callers as they leave messages on the base speaker (see page 38).
<i>Ans. On/Off</i>	Turn your answering system on or off. (To turn your system on or off from the base, just press ON/OFF .)
<i>Record Greeting</i>	Record a personal greeting (see page 35).
<i>Greeting Options</i>	Switch between your personal greeting and the pre-recorded greeting or delete your personal greeting (see page 35).

Getting Your Messages

Accessing your system from a handset (remote operation)

You can access your system from a handset whenever the phone is in standby. Only one handset at a time can access the system through remote operation, and you can't use remote operation if the base is using the answering system.

- ◆ To start remote operation, open the menu and select *Retrieve Msg.* When the phone prompts you to select a line, press **LINE1** or **LINE2**.
- ◆ During remote operation, the handset beeps to let you know it's waiting for your next command. If you don't press any keys for 30 seconds, the phone returns to standby.
- ◆ The icons on the handset's number keys and display show you which number key activates each answering system command; these commands correspond to the answering system keys on the base:

Icon	Command Name	Handset key	Base key
	Play	2	PLAY/STOP
	Stop	5	PLAY/STOP
	Repeat	1	PHONEBOOK/LEFT
	Skip	3	CALLER ID/RIGHT
	Delete	4	DELETE

How to operate your answering system

To...	From the base	From a handset (during remote operation)
play new messages	Press PLAY/STOP then select a line. The system announces the number of new and old messages, then plays the first new message followed by the day and time it was received. Then the system plays the new messages in the order they were received.	Press 2 .
restart the current message	Press PHONEBOOK/LEFT .	Press 1 .

To...	From the base	From a handset (during remote operation)
replay previous messages	Press PHONEBOOK/LEFT repeatedly until you hear the message you want to replay.	Press 1 repeatedly until you hear the message you want to replay.
skip a message	Press CALLER ID/RIGHT .	Press 3 .
delete a message	While the message is playing, press DELETE .	While the message is playing, press 4 .
delete all of your messages	With the phone in standby, press DELETE . When the system prompts you to select a line, press LINE1 or LINE2 .	Not available.
play old messages	After the system plays the new messages, press PLAY/STOP again. When the system prompts you to select a line, press LINE1 or LINE2 .	press 2 .
exit the system	Press PLAY/STOP .	Press END .

Screening Your Calls

Another feature your answering system gives you is *call screening*. While the system is taking a message, you can hear the caller on the base speaker (if you turn on *Call Screen*) or from a handset.

To...	From the base	From a handset
hear the caller leaving a message	Just listen to the caller over the speaker.	Press SCREEN .
answer the call	Press SPEAKER .	Press TALK/FLASH .
mute the call screen without answering	Press MUTE .	

- ◆ If you mute the call screen, the system continues taking the message: it just stops playing through the speaker.
- ◆ Up to four handsets at a time can screen calls. If a fifth handset tries to screen the call, the handset sounds an error tone and displays a *System Busy* message.

Using the System While You're Away from Home

You can also operate your answering system from any touch-tone phone. Before you can use this feature, you have to program a security code.

Programming a security code

1. With the phone in standby, open the menu and select *Ans. Setup*.
2. When the phone prompts you to select a line, press **LINE1** or **LINE2**, then select *Security Code*.
3. Use the number keypad to enter a two-digit security code (01 to 99). Press **OK** when you're finished.

Remember to make a note of your new security code!

Dialing in to your system

1. Call your telephone number and wait for the system to answer. (If your answering system is off, it will answer after about ten rings and sound a series of beeps instead of your greeting.)
2. During the greeting (or beeps), press **0** and **immediately** enter your security code. (You have 3 tries to enter you security code: if you enter it wrong 3 times, the system hangs up and returns to standby.)
3. The system announces the current time, the number of messages stored in memory, and a help prompt. Then it starts beeping intermittently to let you know it's waiting for your command.
4. When you hear the intermittent beeping, enter a command from the chart to the right.

If you don't press any keys for 15 seconds, the phone will hang up and return to standby.

0-1	Repeat message
0-2	Play message
0-3	Skip message
0-4	Delete message
0-5	Stop playback
0-6	Turn the system on
0-9	Turn the system off
1-0	Hear help prompts

Solving Problems

If you have any trouble with your phone, try these simple steps first. If you still have a question, call our Customer Care Line listed on the front cover.

If...	Try...
No stations can make or receive calls.	<ul style="list-style-type: none">- Checking the telephone cord connection.- Disconnecting the base AC adapter. Wait a few minutes, then reconnect it.
One cordless handset can't make or receive calls.	<ul style="list-style-type: none">- Moving the handset closer to the base.- Resetting the handset.
A station can make calls, but it won't ring.	<ul style="list-style-type: none">- Making sure the ringer is turned on.- Making sure Do Not Disturb is turned off (see page 32).
I can't make or receive calls on line 2.	<ul style="list-style-type: none">- Making sure line 2 is properly connected (see page 2).- Checking the dial mode on line 2.- Seeing if another station has activated Privacy Mode on line 2.- Making sure you have subscribed to 2 separate lines from your phone company.
I can't conference line 1 and line 2 together.	<ul style="list-style-type: none">- Seeing if another station has activated Privacy Mode on one of the lines (see page 30).
A cordless handset's display won't turn on.	<ul style="list-style-type: none">- Charging the battery for 15-20 hours.- Checking the battery pack connection.
A cordless handset is not working.	<ul style="list-style-type: none">- Charging the battery for 15-20 hours.- Checking the battery pack connection.- Resetting the handset.
A cordless handset says <i>Unavailable</i> .	<ul style="list-style-type: none">- Moving the handset closer to the base.- Seeing if another station has Privacy Mode on (see page 30).- Making sure the base is plugged in.

If...	Try...
No stations will display any Caller ID information.	<ul style="list-style-type: none"> - Letting calls ring at least twice before answering. - Seeing if the call was placed through a switchboard. - Checking with your telephone service provider to make sure your Caller ID service is active.
I can't dial from the Caller ID list.	<ul style="list-style-type: none"> - Making sure you entered the correct area code. If you have to dial all 10 digits, you need to delete the area code (see "Seven-digit Dialing" on page 24).
Caller ID displays briefly and then clears.	<ul style="list-style-type: none"> - You may have to change the line mode. Contact customer service for more information.
I can't transfer calls.	<ul style="list-style-type: none"> - Resetting all the handsets (see page 44).
I can't get two cordless handsets to talk to the caller.	<ul style="list-style-type: none"> - Making sure both handsets are registered to this base. - Making sure no station is in Privacy Mode (see page 30).
The phone keeps ringing if I answer on an extension.	<ul style="list-style-type: none"> - You may have to change the line mode. Contact customer service for more information.
I can't save a number to an existing phonebook entry.	<ul style="list-style-type: none"> - Seeing if the number is already in the phonebook. - Seeing if that entry already has two phone numbers.
The answering system does not work.	<ul style="list-style-type: none"> - Making sure the answering system is turned on. - Making sure the base AC adapter is not plugged into an that's controlled by a wall switch.
The answering system won't record messages.	<ul style="list-style-type: none"> - Making sure the <i>Record Time</i> is not set to <i>Announce Only</i> (see page 36). - Deleting messages (the memory may be full).
A handset can't access the answering system.	<ul style="list-style-type: none"> - Making sure no other handset is using the system. - Making sure the phone is in standby.
My outgoing message is gone.	<ul style="list-style-type: none"> - Seeing if there was a power failure. You may have to re-record your personal outgoing message.

If...	Try...
I can't hear the base speaker.	<ul style="list-style-type: none"> - Making sure call screening is turned on (see page 36). - Changing the base speaker volume.
Messages are incomplete.	<ul style="list-style-type: none"> - The incoming messages may be too long. Remind callers to leave a brief message. - Deleting messages (the memory may be full).
The system keeps recording if I answer on an extension.	<ul style="list-style-type: none"> - You may have to change the line mode. Contact customer service for more information.
I can't register a handset.	<ul style="list-style-type: none"> - Seeing if there are 10 handsets registered to this base. - Resetting the handset.
My alarm rings at the wrong time.	<ul style="list-style-type: none"> - Making sure the time is set correctly (see page 18).
My alarm won't ring on the right day(s).	<ul style="list-style-type: none"> - Making sure the days are selected (see page 32). - Making sure the date is set correctly (see page 18).

Weak or Hard To Hear Audio

If a caller's voice sounds weak or soft, the signal might be blocked by large metal objects or walls; you might also be too far from the base, or the handset's battery may be weak.

- ◆ Try moving around while you're on a call or moving closer to the base to see if the sound gets louder.
- ◆ Make sure the handset's battery is fully charged.
- ◆ Try adjusting the earpiece volume.

Noise or Static On The Line

Interference is the most common cause of noise or static on a cordless phone. Here are some common sources of interference:

- ◆ electrical appliances, especially microwave ovens
- ◆ computer equipment, especially wireless LAN equipment and DSL modems

- ◆ radio-based wireless devices, such as room monitors, wireless controllers, or wireless headphones or speakers
- ◆ large florescent light fixtures (especially if they give off a buzzing noise)
- ◆ other services that use your phone line, like alarm systems, intercom systems, or broadband Internet service

Do you use a T-Coil hearing aid?

If you have a hearing aid equipped with a telecoil (T-coil) feature, the interaction between the hearing aid and digital cordless phones can cause noise in the handset. If you have a T-coil hearing aid and you have problems with noise on the line, try turning on *T-coil* mode. Open the menu; select *Handset Setup*, then select *T-coil*.

Using T-coil mode can shorten the handset's talk time; make sure to watch the battery status and keep the battery charged.

Here are some hints for when the static is...

on 1 handset or in 1 location:	on all handsets or in all locations:
<ul style="list-style-type: none"> - Check nearby for one of the common interference sources. - Try moving the handset away from a suspected source, or try moving the suspected source so it's not between the handset and the base. - Try moving closer to the base. There is always more noise at the edges of the base's range. If the handset displays an <i>Out of Range</i> message, you need to move closer to the base. 	<ul style="list-style-type: none"> - Check near the base for the source of interference. - Try moving the base away from a suspected source, or turn off the source if possible. - If the base has an adjustable antenna, try raising the antenna so it stands straight up. - If you have any service that uses the phone line, you might need a filter (see below).

Installing a line filter or DSL filter

Sometimes, broadband Internet services that use the telephone line can interfere with phones. One of these services—DSL—often causes static on telephones. A DSL filter or telephone line filter usually solves this problem. The technician who installed your DSL service might have left some filters for you; if not, call your DSL provider or look in any electronics store.

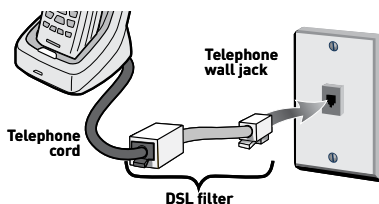

Plug the DSL filter into the telephone wall jack and plug your phone's base into the filter. Make a test call to make sure the noise is gone.

Resetting and Registering Handsets

If you are having trouble with a cordless handset or if you want to replace one, you need to clear the registration information from the base and the handset:

Do you have the base the handset is registered to?	
Yes	No
<ol style="list-style-type: none">1. Press and hold END and # until the <i>System Reset</i> menu appears (about 5 seconds).2. Select <i>Deregister HS</i>. The display lists all registered handsets.3. Select the handset you want to reset.4. When the handset asks you to confirm, select <i>Yes</i>. (It may ask you twice, just to be sure.) The handset clears its information from the base and deletes its own link to the base.	<ol style="list-style-type: none">1. Press and hold END and # until the <i>System Reset</i> menu appears (about 5 seconds).2. Select <i>Base Unavailable</i>.3. When the handset asks you to confirm, select <i>Yes</i>. (It may ask you twice, just to be sure.) The handset deletes its own link without contacting the base.

When you reset a handset (or if you buy a new one), that handset displays a *Handset Not Registered* message. If you see this message on a handset, you need to register it to a base before you can use it.

Registering a handset

Does the handset fit in the base cradle?	
Yes	No
Place the handset in the base. The display should say <i>Handset Registering</i> .	<ol style="list-style-type: none">1. On the base, open the menu and select <i>Register Handset</i>. The display should say <i>Handset Registering</i>.2. On the handset you want to register, press and hold # until the display says <i>Handset Registering</i> (about 2 seconds).

In about 30 seconds, the handset display should say *Registration Complete*. Press **TALK/FLASH** and make sure you get a dial tone.

If...	Try...
- you don't hear a dial tone - the display says <i>Registration Failed</i>	Making sure the handset is fully charged, then start over at step 1.

To register a handset to a different base, see the section "Expanding Your Phone" in the user's guide for the other base.

Handling Liquid Damage

Moisture and liquid can damage your cordless phone.

- ◆ If the handset or base is exposed to moisture or liquid, but only the exterior plastic housing is affected, wipe off the liquid, and use as normal.
- ◆ If moisture or liquid has entered the plastic housing (i.e. liquid can be heard in the phone or liquid has entered the handset battery compartment or vent openings on the base), follow these steps:

Handset	Base
<ol style="list-style-type: none">1. Remove the battery cover and disconnect the battery.2. Let dry for at least 3 days with the battery disconnected and the cover off for ventilation.3. After the handset dries, reconnect the battery pack and replace the cover. Recharge the battery fully (15-20 hours) before using.	<ol style="list-style-type: none">1. Disconnect the AC adapter to cut off the power.2. Disconnect the telephone cord.3. Let dry for at least 3 days before reconnecting.

IMPORTANT: You must unplug the telephone line while recharging the battery pack to avoid charge interruption.

CAUTION! *DO NOT use a microwave oven to speed up the drying process. This will cause permanent damage to the handset, base and the microwave oven.*

Important Information

Terms Used In This Guide

Accessory Handset	An extra handset that can register to and be used with an expandable phone base. All accessory handsets must be registered to a base.
Base	The main part of the phone. It connects to your phone line and lets you make and receive calls. Most bases also have a cradle to store a handset.
CIDCW	(CID on Call Waiting.) A service that shows CID for calls that come in during another call.
Call Waiting	A service that lets you receive calls while you are on another call.
Caller ID	(Also called CID.) A service that shows the name and number of incoming callers.
Charger	A cradle that stores and charges a handset but doesn't connect to the phone line.
Cradle	The part of the phone that stores a handset. While in a cradle, a handset is always in standby, and any keys are locked.
During a call	The station is currently on a call or has activated a dial tone.
Handset	A cordless handset that you use to dial the phone and talk to callers.
In standby	The phone is inactive: there is no dial tone, no station is on a call or listening to messages.
Line 1 and Line 2	On a two-line jack, line 1 is connected to the inner pair of wires, and line 2 is connected to the outer pair of wires. If you want to switch the lines, contact your phone company. On single-line jacks, line 1 is connected to TEL LINE 1/2 , and line 2 is connected to TEL LINE 2 . You can switch Line 1 and Line 2 just by swapping the connectors.
Off hook	The phone is connected to an outside line: there is a dial tone or an ongoing call.
Soft key	A software-controlled button that can change its function to fit the current operation.
Station	Any handset or the base.

Specifications

		Base	Charger
AC adapter	Part number	PS-0034	PS-0035
	Input voltage	120V AC, 60 Hz	120V AC, 60 Hz
	Output voltage	7.8V AC @ 450mA	8V AC @ 300mA
Battery pack	Part number	BT-1018	
	Capacity	500mAh, 2.4V DC	

- Use only the supplied AC adapters.
- Be sure to use the proper adapter for the base and any chargers.
- Do not place the power cord where it creates a trip hazard or where it could become chafed and create a fire or electrical hazard.

- Do not place the base in direct sunlight or subject it to high temperatures.

Battery Information

- Fully charged, the battery should provide about 10 hours of talk time and about 7 days of standby time. For best results, return the handset to the cradle after each call to keep it fully charged.
- Keep an eye on the battery status icon. When the battery gets too low, the handset shows a low battery alert. If you hear a strange beep during a call, check the display: if you see the low battery alert, finish your conversation as quickly as possible and return the handset to the cradle. If the handset is in standby, none of the keys will operate.

- With normal use, the battery should last about one year. Replace the battery when the talk time becomes short even when the battery is charged. To buy a replacement battery, call the Parts Department listed on the front cover.

Rechargeable Nickel-Metal-Hydride Battery Warning

CAUTION! Risk of explosion if battery is replaced by an incorrect type! Dispose of used batteries according to the instructions. Do not open or mutilate the battery. Disconnect the battery before shipping this product.

- This equipment contains a rechargeable Nickel-Metal-Hydride battery.
- The rechargeable batteries contained in this equipment may explode if disposed of in a fire.
- Nickel is a chemical known to state of California to cause cancer.
- Do not short-circuit the battery.
- Do not charge the rechargeable battery pack used in this equipment with in any charger other than the one designed to charge this battery pack as specified in the owner's manual. Using another charger may damage the battery pack or cause the battery pack to explode.

Rechargeable Batteries Must Be Recycled or Disposed of Properly.

Uniden works to reduce lead content in PVC coated cords in our products & accessories.

Warning! The cords on this product and/or accessories contain lead, a chemical known to the State of California to cause birth defects or other reproductive harm. Wash hands after handling.

Compliance Information

FCC Part 68 information

This equipment complies with Part 68 of the FCC rules & the requirements adopted by the ACTA. On the bottom of this equipment is a label that contains, among other information, a product identifier in the format US: AAAEQ##TXXXX. If requested, this number must be provided to the phone company.

An applicable Universal Service Order Codes (USOC) certification for the jacks used in this equipment is provided (i.e., RJ11C) in the packaging with each piece of approved terminal equipment. A plug & jack used to connect this equipment to the premises wiring & telephone network must comply with the applicable FCC Part 68 rules & requirements adopted by the ACTA. A compliant telephone cord & modular plug is provided with this product. It is designed to be connected to a compatible modular jack that is also compliant. See installation instructions for details.

The REN is used to determine the number of devices that may be connected to a phone line. Excessive RENs on a phone line may result in devices not ringing in response to an incoming call. In most but not all areas, the sum of RENs should not exceed five (5.0). To be certain of the number of devices that may be connected to a line, as determined by the total RENs, contact the telephone provider. The REN for this product is part of the product identifier that has the format US:AAAEQ##TXXXX. The digits represented by ## are the REN without a decimal point (e.g., 03 is a REN of 0.3).

If this equipment causes harm to the telephone network, the telephone company will notify you in advance that temporary discontinuance of service may be required. But if advance notice

isn't practical, the telephone company will notify the customer as soon as possible. Also, you will be advised of your right to file a complaint with the FCC if you believe it is necessary. The telephone company may make changes in its facilities, equipment, operations or procedures that could affect the operation of the equipment. If this happens the telephone company will provide advance notice in order for you to make necessary modifications to maintain uninterrupted service.

Please follow instructions for repairing, if any (e.g. battery replacement section); otherwise do not substitute or repair any parts of the device except as specified in this manual. Connection to party line service is subject to state tariffs. Contact the state public utility commission, public service commission or corporation commission for information. This equipment is hearing aid compatible.

If you experience trouble with this equipment, contact the manufacturer (see the cover of this manual for contact information) or an authorized agent. If the equipment is causing harm to the telephone network, the telephone company may request that you disconnect the equipment until the problem is resolved.

If your home has wired alarm equipment connected to a phone line, be sure that installing the system does not disable your alarm equipment. If you have questions about what will disable alarm equipment, contact your telephone company or a qualified installer.

Any changes or modifications to this product not expressly approved by the manufacturer or other party responsible for compliance could void your authority to operate this product.

NOTICE: According to telephone company reports, AC electrical surges, typically resulting from lightning strikes, are very destructive to telephone equipment connected to AC power sources. To minimize damage from these types of surges, a surge arrester is recommended.

FCC Part 15 information

This device complies with part 15 of the FCC rules. Operation is subject to the following two conditions: (1) This device may not cause harmful interference, & (2) This device must accept any interference received, including interference that may cause undesired operation. Privacy of communications may not be ensured when using this phone.

FCC PART 15.105(b)

Note: This equipment has been tested & found to comply with the limits for a Class B digital device, pursuant to part 15 of the FCC Rules. These limits are designed to provide reasonable protection against harmful interference in a residential installation. This equipment generates, uses & can radiate radio frequency energy and, if not installed & used in accordance with the instructions, may cause harmful interference to radio communications. However, there is no guarantee that interference will not occur in a particular installation. If this equipment does cause harmful interference to radio or television reception, which can be determined by turning the equipment off & on, the user is encouraged to try to correct the interference by one or more of the following measures:

- ♦ Reorient or relocate the receiving antenna.
- ♦ Increase the separation between the equipment and receiver.
- ♦ Connect the equipment into an outlet on a circuit different from that to which the receiver is connected.
- ♦ Consult the dealer or an experienced radio/TV technician for help.

RF exposure information

This product complies with FCC radiation exposure limits under the following conditions:

- The base must be placed to allow a minimum of 20 cm (8 inches) between the antenna and all persons during normal operation.
- The base must not be collocated or operated in conjunction with any other antenna or transmitter.
- The handset is designed for body-worn operation and meets FCC RF exposure guidelines when used with any belt clip, carrying case, or other accessory supplied with this product. (All necessary accessories are included in the package; any additional or optional accessories are not required for compliance with the guidelines.) Third party accessories (unless approved by the manufacturer) should be avoided as these might not comply with FCC RF exposure guidelines.

Industry Canada (I.C.) Notice

Terminal equipment

NOTICE: This equipment meets the applicable Industry Canada Terminal Equipment Technical Specifications. This is confirmed by the registration number. The abbreviation *IC* before the registration number signifies that registration was performed based on a Declaration of Conformity indicating that Industry Canada technical specifications were met. It does not imply that Industry Canada approved the equipment.

NOTICE: The Ringer Equivalence Number (REN) for this terminal equipment is marked on the equipment itself. The REN assigned to each terminal equipment provides an indication of the maximum number of terminals allowed to be connected to a telephone interface. The termination on an interface may consist of any combination of devices subject only to the requirement that the sum of the Ringer Equivalence Numbers of all the devices does not exceed 5.

Radio equipment

The term *IC* before the radio certification number only signifies that Industry Canada technical specifications were met. Operation is subject to the following two conditions: (1) this device may not cause interference, & (2) this device must accept any interference, including interference that may cause undesired operation of the device. "Privacy of communications may not be ensured when using this telephone".

One-year Limited Warranty

Important: Evidence of original purchase is required for warranty service.

WARRANTOR: UNIDEN AMERICA CORPORATION ("Uniden") ELEMENTS OF WARRANTY: Uniden warrants, for one year, to the original retail owner, this Uniden Product to be free from defects in materials & craftsmanship with only the limitations or exclusions set out below.

WARRANTY DURATION: This warranty to the original user shall terminate & be of no further effect 12 months after the date of original retail sale. The warranty is invalid if the Product is (A) damaged or not maintained as reasonable or necessary, (B) modified, altered, or used as part of any conversion kits, subassemblies, or any configurations not sold by Uniden, (C) improperly installed, (D) serviced or repaired by someone other than an authorized Uniden service center for a defect or malfunction covered by this warranty, (E) used in any conjunction with equipment or parts or as part of any system not manufactured by Uniden, or (F) installed or programmed by anyone other than as detailed by the owner's manual for this product.

STATEMENT OF REMEDY: In the event that the product does not conform to this warranty at any time while this warranty is in effect, warrantor will either, at its option, repair or replace the defective unit & return it to you without charge for parts, service, or any other cost (except shipping & handling) incurred by warrantor or its representatives in connection with the performance of this warranty. Warrantor, at its option, may replace the unit with a new or refurbished unit. THE LIMITED WARRANTY SET FORTH ABOVE IS THE SOLE & ENTIRE WARRANTY PERTAINING TO THE PRODUCT & IS IN LIEU OF & EXCLUDES ALL OTHER WARRANTIES OF ANY NATURE WHATSOEVER, WHETHER EXPRESS, IMPLIED OR ARISING BY OPERATION OF LAW, INCLUDING, BUT NOT LIMITED TO ANY IMPLIED WARRANTIES OF MERCHANTABILITY OR FITNESS FOR A PARTICULAR PURPOSE. THIS WARRANTY DOES NOT COVER OR PROVIDE FOR THE REIMBURSEMENT OR PAYMENT OF INCIDENTAL OR CONSEQUENTIAL DAMAGES. Some states do not allow this exclusion or limitation of incidental or consequential damages so the above limitation or exclusion may not apply to you.

LEGAL REMEDIES: This warranty gives you specific legal rights, & you may also have other rights which vary from state to state. This warranty is void outside the United States of America & Canada.

PROCEDURE FOR OBTAINING PERFORMANCE OF WARRANTY: If, after following the instructions in the owner's manual you are certain that the Product is defective, pack the Product carefully (preferably in its original packaging). Disconnect the battery from the Product & separately secure the battery in its own separate packaging within the shipping carton. The Product should include all parts & accessories originally packaged with the Product. Include evidence of original purchase & a note describing the defect that has caused you to return it. The Product should be shipped freight prepaid, by traceable means, to warrantor at:

Uniden America Service
4700 Amon Carter Blvd.
Fort Worth, TX 76155

As an Energy Star® Partner, Uniden has determined that this product meets the Energy Star® guidelines for energy efficiency. Energy Star® is a U.S. registered mark.



- Uniden® is a registered trademark of Uniden America Corporation.
- Call waiting, CID, CIDCW, and Voice Mail are telephone line services. Your phone supports these services, but you have to arrange for them through your telephone provider. Contact your provider for details.
- The pictures in this manual are for example only. Your phone may not look exactly like the pictures.

May be covered under one or more of the following U.S. patents:

5,491,745	5,533,010	5,574,727	5,581,598	5,606,598	5,650,790	5,660,269	5,663,981	5,671,248
5,717,312	5,732,355	5,754,407	5,758,289	5,768,345	5,787,356	5,794,152	5,801,466	5,825,161
5,864,619	5,893,034	5,912,968	5,915,227	5,929,598	5,930,720	5,960,358	5,987,330	6,044,281
6,070,082	6,076,052	6,125,277	6,253,088	6,314,278	6,321,068	6,418,209	6,618,015	6,714,630
6,782,098	6,788,920	6,788,953	6,839,550	6,889,184	6,901,271	6,907,094	6,914,940	6,940,867
6,953,118	7,023,176	7,030,819	7,146,160	7,203,307	7,206,403	7,310,398	7,460,663	

Other patents pending.