

CEZAI2998 Series User's Guide

What's in the box?

Corded handset



Coiled cord
(to connect handset to base)

CEZAI2998 base with answering system

Base AC adapter (PS-0034)

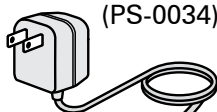

Telephone cord

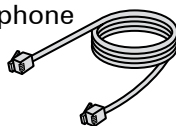

Desk/wall mount stand (may be attached to the base)

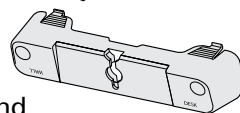

You will also find:

EZX290 accessory handset and charger

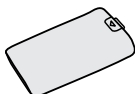

Battery cover

Charger AC adapter (PS-0035)

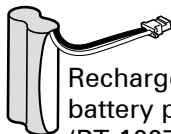
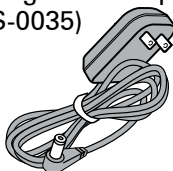

Rechargeable battery pack (BT-1007)

If you purchased model number:	You should have:
CEZAI2998	1 of each
CEZAI2998-2	2 of each
CEZAI2998-3	3 of each
CEZAI2998-4	4 of each
CEZAI2998-5	5 of each
CEZAI2998-6	6 of each

If any items are missing or damaged, contact our Customer Care Line immediately. Never use damaged products!

Need Help? Get answers 24/7 at our website: www.uniden.com.

If You...	Contact Uniden's...	Phone Number
have a question or problem	Customer Care Line*	817-858-2929 or 800-297-1023
need a replacement part or an accessory (headset, belt clip, etc.)	Parts Department*	800-554-3988
need special assistance due to a disability	Accessibility Help Line	800-874-9314 (voice or TTY)

* During regular business hours, Central Standard Time. Visit our website for detailed business hours.

What's in the manual?

Installing Your Phone	1	Using Privacy Mode	18
Set Up the Base.....	1	Using Call Transfer	19
Test the Connection	3	Using the Intercom.....	19
Set Up the Accessory Handset(s).....	3	Using Special Features	20
Getting to Know Your Phone	5	Using Your Phone During a Power	
Parts of the Base	5	Failure	20
Parts of the Handset.....	7	Using Do Not Disturb	20
Reading the Displays	8	Adjusting the Base Visual Ringer	20
Using the Menus	10	Using the Audio Boost	20
The <i>Handset Setup</i> Menu	10	Using Text-To-Speech	21
The <i>Base Setup</i> Menu	11	Using Voice Message Notification.....	21
The <i>Ans. Setup</i> Menu	11	Using the Answering System	22
<i>Day & Time</i> Setting	11	Setting Up Your Answering System ...	22
The <i>Global Setup</i> Menu	12	Getting Your Messages.....	23
<i>Register Handset</i> (Base Only).....	12	Screening Your Calls.....	24
Entering Text on Your Phone	12	Using the System While You're Away	
Using Your Phone	13	from Home	25
Using the Speakerphone	13	Solving Problems	26
Changing the Volume	14	Weak or Hard To Hear Audio	27
Using the Redial List.....	14	Noise or Static On The Line	28
Using Caller ID and Call Waiting.....	14	Resetting and Registering Handsets ...	29
Using Seven-Digit Dialing	15	Handling Liquid Damage	30
Using the Phonebook.....	16	Important Information	31
Chain Dialing	17	Terms Used In This Guide	31
Finding a Lost Handset	17	Specifications	31
Using an Optional Headset	17	Battery Information	31
Using Multi-station Features	18	Compliance information	32
Expanding Your Phone	18	One-year Limited Warranty	34
Using Conference Calling	18		

Important Safety Precautions!

When using your telephone equipment, basic safety precautions should always be followed to reduce the risk of fire, electric shock and injury to persons, including the following:

- ◆ **This unit is NOT waterproof.** DO NOT expose it to rain or moisture.
- ◆ Do not use this product near water, for example, near a bath tub, wash bowl, kitchen sink or laundry tub, in a wet basement or near a swimming pool.
- ◆ Avoid using a telephone (other than a cordless type) during an electrical storm. There may be a remote risk of electric shock from lightning.
- ◆ Do not use the telephone to report a gas leak in the vicinity of the leak.
- ◆ Use only the power cord and batteries indicated in this manual. Do not dispose of batteries in a fire. They may explode. Check with local codes for possible special disposal instructions.
- ◆ Do not place the handset in any charging cradle without the battery installed and the battery cover securely in place.

SAVE THESE INSTRUCTIONS!

Installing Your Phone

Set Up the Base

Attach the stand

Before you attach the stand, you have to decide if you want the phone to rest on a desk or hang on a wall.

For desktop use

- 1) Turn the stand so the word **DESK** is right side up (it will be on the left).
- 2) Insert the tabs into the notches at the top of the base.
- 3) Press in on the latches and slip them into the notches marked **DESK**.

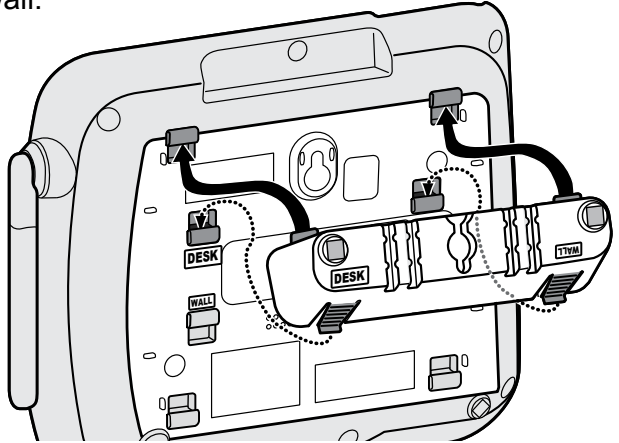

For wall mount use

- 1) Turn the stand so the word **WALL** is right side up (it will be on the left).
- 2) Insert the tabs into the notches at the bottom of the base.
- 3) Press in on the latches and slip them into the notches marked **WALL**.

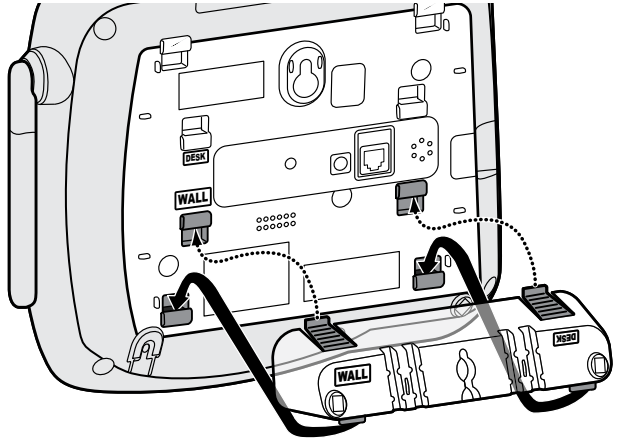

To remove the stand

Press in on the latches and slide them out of the notches.

Connect the corded handset

Use the coiled cord to connect the corded handset to the connector on the left side of the base.

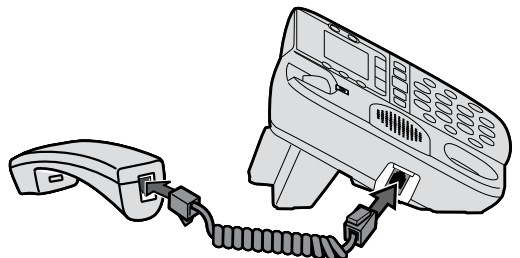

For wall mount use only

- 1) On the front of the base, pull the clip (that holds the corded handset in place) out of its slot.
- 2) Rotate the clip 180 degrees.
- 3) Flip it from front to back and slide it back into the slot.

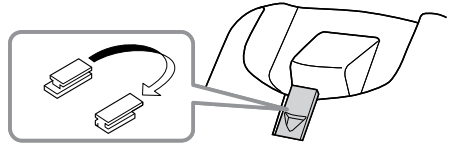

Connect the power and telephone cords

- 1) Connect the base AC adapter to the **AC IN 7.8V** jack and the telephone cord to the **TEL LINE** jack. Route the cords as shown below:

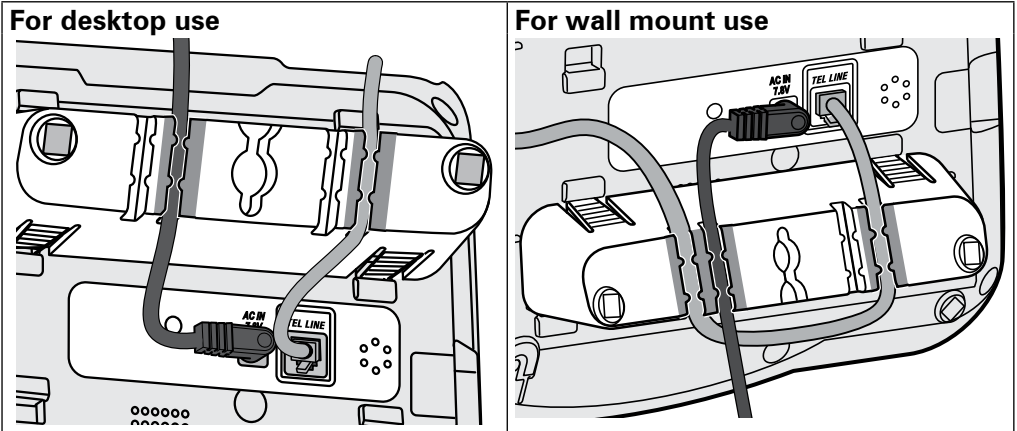

- 2) Plug the AC adapter into a standard 120 V AC power outlet, and connect the telephone cord to a standard telephone wall jack.

Place the phone on the wall

Place the mounting slots over the pins on the wall plate, and slide the base down to lock it into place.

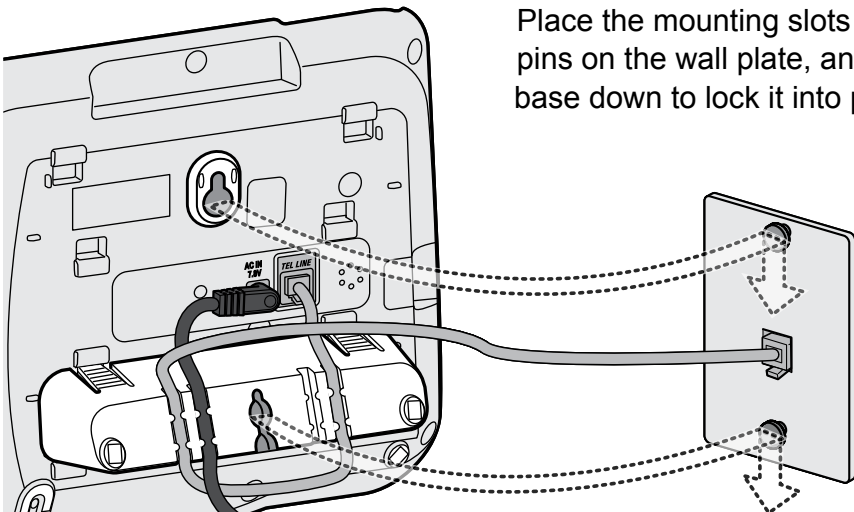

Test the Connection

Pick up the corded handset from the base. You should hear a dial tone and the display on the base should say *Talk*. When you get a dial tone, make a quick test call.

If...	Try...
the display says <i>Check Tel Line</i> or you don't hear a dial tone	checking the connection between the base and the phone jack.
you keep hearing a dial tone	changing to pulse dialing (see below).
there's a lot of noise or static	see page 28 for tips on avoiding interference.

Changing from Tone to Pulse Dialing

Phones can communicate with the telephone network in two different ways: tone (DTMF) or pulse dialing. If you know your phone company uses pulse dialing or you can't make your test call, follow these steps:

- 1) With the phone in standby, press **SELECT/MENU**.
- 2) Use **UP** or **DOWN** to highlight *Global Setup*, then press **SELECT/MENU**.
- 3) Use **UP** or **DOWN** to highlight *Dial mode*, then press **SELECT/MENU**.
- 4) Highlight *Pulse*, then press **SELECT/MENU**. The phone sounds a confirmation tone. Try making another test call.

If you use pulse dialing and you need to send DTMF tones during a call (if you're using an automated response system, for example), press ***** to temporarily switch to tone dialing. When the call ends, the phone automatically returns to pulse dialing mode.

Set Up the Accessory Handset(s)

If your phone came packaged with accessory handsets, follow the steps below to get your cordless handsets ready for use.

Install the battery

- 1) Unpack all handsets, battery packs, and battery covers. If any handset has the battery cover already attached, press in on the notch and slide the cover down and off.

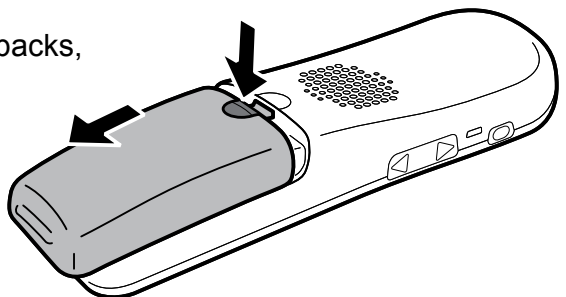

- 2) Line up the red and black wires on the battery pack with the label inside the handset.
- 3) Push the battery pack connector in until it clicks into place. Tug gently on the wires to make sure the battery pack is securely connected.

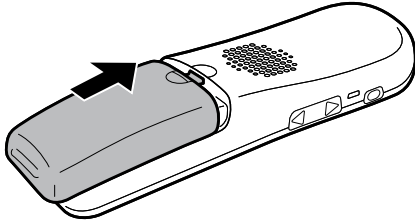
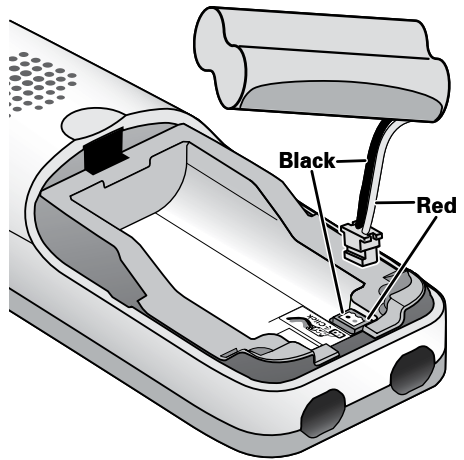

- 4) Place the cover over the battery compartment and slide it up into place.

Connect the charger

- 1) Connect a charger AC adapter to each charger's **AC IN 8V** jack and set the plug into the notch as shown. (These adapters might already be connected.)
- 2) Plug the other end of the adapter into a standard 120V AC power outlet.
- 3) Place each handset in a charger with the display facing forward. The **CHARGE** light should turn on.

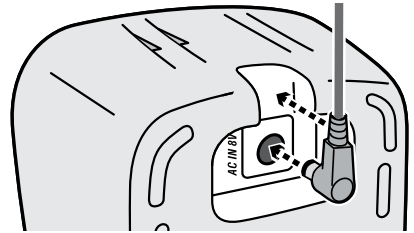

If...	Try...
the CHARGE light doesn't turn on	- reseating the handset. - checking the AC adapter connection. - seeing if the outlet is controlled by a wall switch.

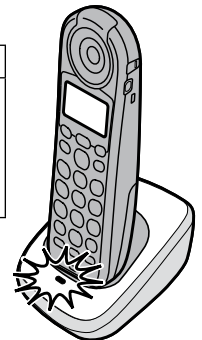

Charge all handsets completely (about 15 hours) before using them.

Test the connection

Pick up each handset and press **TALK**. You should hear a dial tone, and the display should say *Talk*. (Press **TALK** again to hang up.)

If you can't get a dial tone or the handset display says *Unavailable*, try moving the handset closer to the base or resetting it (see page 29).

Getting to Know Your Phone

Parts of the Base

If the key name is spelled out on the key itself, it's not labeled in the drawing below.

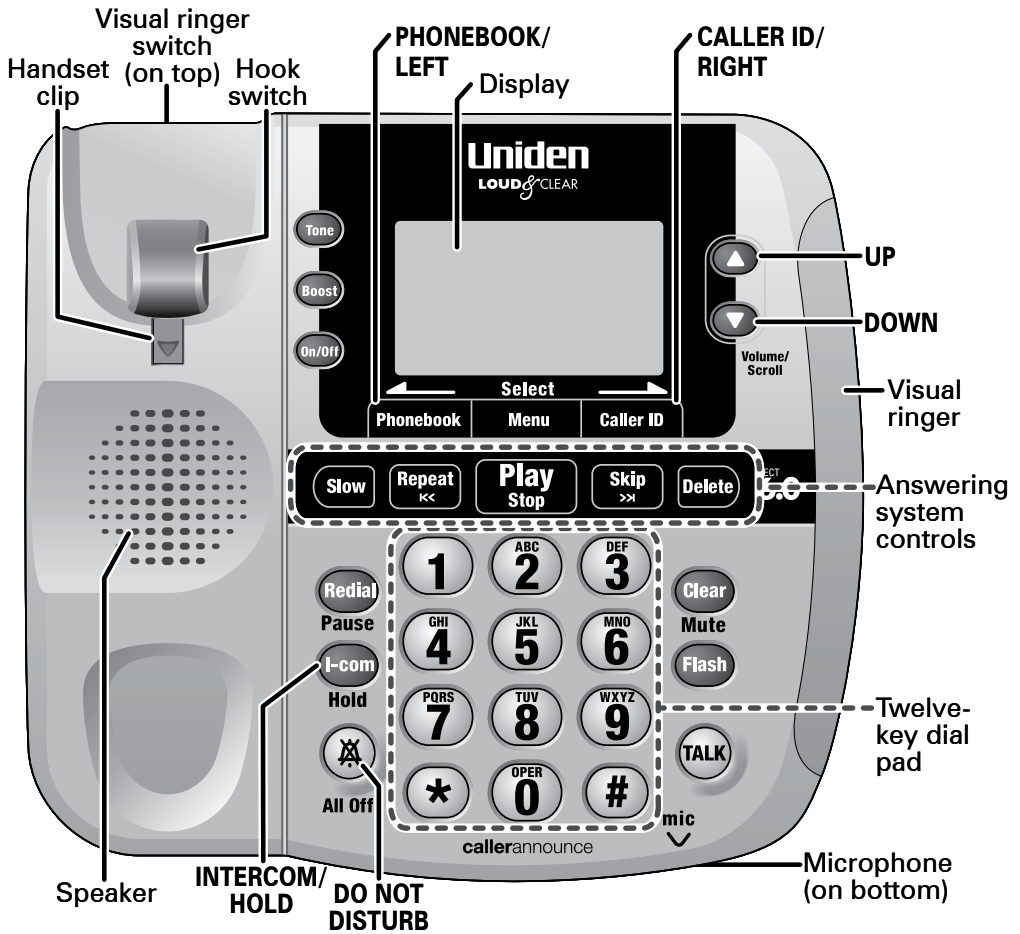

Base keys and how they work

Key name (and icon)	What it does
TONE	- During a call: adjust the audio tone (see page 27).
BOOST	- During a call: boost the volume of the earpiece (see page 20).
ON/OFF	- In standby: turn the answering system on or off.
SLOW	- Reduce the speed of the answering system playback by 30%.

Key name (and icon)	What it does
REDIAL/ PAUSE	- In standby: open the redial list. - During a phone number entry: insert a two-second pause.
INTERCOM/ HOLD	- In standby: page a handset using the intercom. - During a call: put the call on hold and start a call transfer.
DO NOT DISTURB (X)	- In standby: turn the Do Not Disturb feature on or off (see page 20).
PHONEBOOK/ LEFT	- In standby or during a call: open the phonebook. - In the menu: go back to the previous screen. - During text entry: move the cursor to the left.
SELECT/ MENU	- In standby: open the menu. - In the menu or any list: select the highlighted item.
CALLER ID/ RIGHT	- In standby or during a call: open the Caller ID list. - During text entry: move the cursor to the right.
REPEAT (◀◀)	- In the first 2 seconds of a message: go to the previous message. - Anytime after that: go back to the beginning of this message.
PLAY/STOP	- In standby: start playing new messages. - While a message is playing: stop playing messages.
SKIP (▶▶)	- While a message is playing: skip to the next message.
UP (▲)	- In standby: increase the ringer volume. - During a normal call: increase the earpiece volume. - During a speakerphone call or while a message is playing: increase the speaker volume. - In the menu or any list: move the cursor up one line.
DOWN (▼)	- In standby: decrease the ringer volume. - During a normal call: decrease the earpiece volume. - During a speakerphone call or while a message is playing: decrease the speaker volume. - In the menu or any list: move the cursor down one line.
DELETE	- While a message is playing: delete this message. - In standby: delete all messages.
CLEAR/MUTE	- While the phone is ringing: mute the ringer for this call only. - During a call: mute the microphone. - While entering text: delete the last character, or press and hold to delete all the characters.
FLASH	- During a call: switch to a waiting call.
TALK	- In standby: start a speakerphone call (get a dial tone). - During a normal call: switch to the speakerphone. - During a speakerphone call: hang up.

Parts of the Handset

If the key name is spelled out on the key itself, it's not labeled in the drawing below.



Handset keys and how they work

Key name (and icon)	What it does
PHONEBOOK/ LEFT (PHBK)	<ul style="list-style-type: none"> - In standby or during a call: open the phonebook. - In the menu: go back to the previous screen. - During text entry: move the cursor to the left.
SPEAKER (SPKR)	<ul style="list-style-type: none"> - Switch a normal call to the speakerphone (and back).
SELECT/MENU	<ul style="list-style-type: none"> - In standby: open the menu. - In the menu or any list: select the highlighted item.

Key name (and icon)	What it does
CALLER ID/ RIGHT (CID)	- In standby or during a call: open the Caller ID list. - During text entry: move the cursor to the right.
TALK	- In standby: start a telephone call (get a dial tone). - During a call: hang up.
FLASH/EXIT	- During a call: switch to a waiting call. - While the phone is ringing: mute the ringer for this call only. - In the menu or any list: exit the menu and go back to the previous operation.
CLEAR/ INTERCOM	- In standby: page another station using the intercom. - During a call: put the call on hold and start a call transfer. - While entering text: delete the last character, or press and hold to delete all the characters.
REDIAL/PAUSE	- In standby: open the redial list. - During a phone number entry: insert a two-second pause.
MUTE/ MESSAGES	- In standby: access your answering system. - During a call: mute the microphone. - While the phone is ringing: mute the ringer for this call only.
BOOST	- During a call: boost the volume of the earpiece (see page 20).
UP (▲)	- In standby: increase the ringer volume. - During a call: increase the call volume. - In the menu or any list: move the cursor up one line.
DOWN (▼)	- In standby: decrease the ringer volume. - During a call: decrease the call volume. - In the menu or any list: move the cursor down one line.
TONE	- During a call: adjust the audio tone (see page 27).

Reading the Displays

On the base

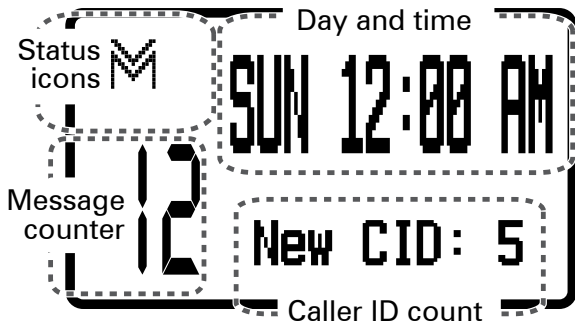



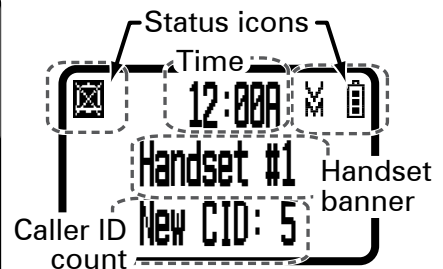



On the handset





The next three tables show the possible icons and what they mean. Since the icons appear based on what you're doing with the phone, you won't ever see all of these icons at the same time.



Icons you might see on both the base and handset

Icon	What it means
	The volume of the earpiece is boosted (see page 20).
	The ringer is turned off: this station will not ring when a call comes in.
	You have a voice message waiting (see the section titled "Using Voice Message Notification" on page 21).
	Privacy Mode is on: no other station can use the line or join your call.
	The speakerphone is on.
	The microphone is muted, and the caller can't hear you.

Icons you might see only on the base

Icon	What it means
	The answering system is turned off: the system will not answer the phone or take messages.
	The memory on the answering system is full: you need to delete some messages before the system can record any new ones.
	The answering system is set to Announce Only: the system will answer the phone, but it will not let callers leave a message.

Icons you might see only on the handset

Icon	What it means
	T-coil mode is on. (See "Do you have a T-coil hearing aid?" on page 28.)
	The battery is 1) fully charged, 2) half charged, 3) getting low, or 4) empty.

Using the Menu

The menus are designed to be as easy as possible. Some users don't even need the manual once they know how to perform these actions:

Open the menu	Press SELECT/MENU .
Move the cursor	The arrow cursor on the left side of the line shows which menu item is currently highlighted. Use UP to move the cursor up and DOWN to move it down.
Select an option	Move the cursor to highlight the option, then press SELECT/MENU .
Go back to the previous screen	Press PHONEBOOK/LEFT .
Close the menu	- On the handset, press FLASH/EXIT . - On the base, press PLAY/STOP .

If you don't press any keys for thirty seconds, the phone times out and exits the menu. (When setting the day and time, the time-out period is extended to two minutes.)

Using the handset menus

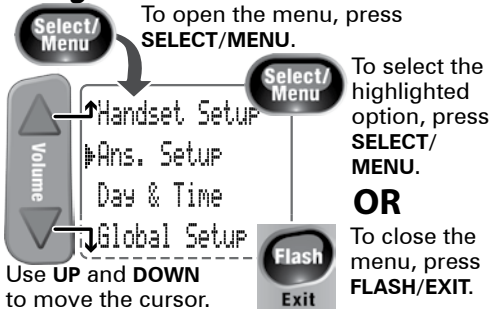

Using the base menus

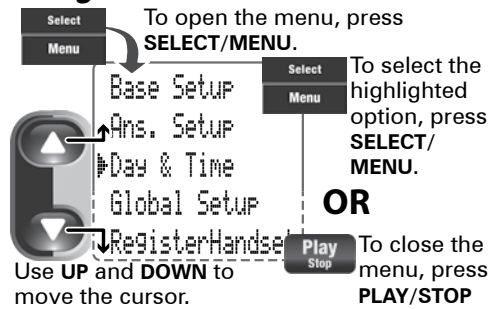

The Handset Setup Menu

You have to change these settings separately for each cordless handset.

<i>T-coil</i>	Turn on T-coil mode to reduce noise on certain hearing aids (see "Do you have a T-coil hearing aid?" on page 28).
<i>Ringer Tones</i>	Choose one of two melodies or five tones for the handset's main ring tone. As you highlight each ring tone, the phone plays a sample of the tone. When you hear the tone you want, press SELECT/MENU .

<i>Personal Ring</i>	Turn on the personal ring feature. If you have Caller ID, this feature lets you assign special ring tones to anyone in your phonebook, and your phone uses the special ring tone when that person calls.
<i>Autotalk</i>	Turn on Auto Talk so you can answer the phone just by picking up the handset from the cradle (without pressing any buttons).
<i>Any Key Answer</i>	Turn on Any Key Answer so you can answer the phone by pressing any key on the twelve-key dial pad.
<i>Banner</i>	Change the name used on the handset's display.
<i>Handset Language</i>	Change the display language to <i>Spanish</i> or <i>French</i> .
<i>Key Touch Tone</i>	Have your keypad sound a tone when you press a key.
<i>LCD Contrast</i>	Change the contract of the display to make it easier to read. Choose one of ten different levels of contrast.
<i>TTS On/Off</i>	Turn on the Text-To-Speech (TTS) feature (see page 21).

The Base Setup Menu

These settings apply only to the base. These options work the same as the *Handset Setup* menu options with the same name.

<i>Ringer Tones</i>	Choose one of four ring tones for the base. As you highlight each ring tone, the base plays a sample of the tone. When you hear the tone you want, press SELECT/MENU .
<i>Base Language</i>	Change the display language to <i>Spanish</i> or <i>French</i> .
<i>Key Touch Tone</i>	Have the keypad sound a tone when you press a key.
<i>LCD Contrast</i>	Change the contract of the display to make it easier to read. Choose one of ten different levels of contrast.
<i>TTS On/Off</i>	Turn on the Text-To-Speech (TTS) feature (see page 21).

The Ans. Setup Menu

This menu controls the options and settings for your answering system (see "Ans. Setup menu options" on page 23).

Day & Time Setting

You need to set the day and time so messages get the correct time stamp.

- 1) Use **UP** and **DOWN** to choose the day of the week; press **SELECT/MENU**.
- 2) Use the number keypad to enter the hour and minutes.
- 3) Use **UP** and **DOWN** to select *AM* or *PM*; press **SELECT/MENU**.

The Global Setup Menu

The settings on this menu apply to all the handsets and the base. Before changing these settings, make sure the phone is in standby and all handsets are within range of the base. (Only one station at a time can change these settings.)

<i>Area Code</i>	Enter your area code so the phone hides the area code on incoming local calls (see "Using Seven-digit Dialing" on page 15).
<i>Dial Mode</i>	Change the way your phone communicates with the telephone network (see "Changing from Tone to Pulse Dialing" on page 3).
<i>Set Line Mode</i>	Do not change this setting unless instructed to by customer service.
<i>VMWI Reset</i>	(Base only) Reset the voice message waiting indicator to bring it back into sync with your voice mail service (see page 21).

Register Handset (Base Only)

This menu lets you register additional handsets to this base or re-register a handset that you had to reset for some reason (see "Resetting and Registering Handsets" on page 29). If you want to use other accessory handsets, visit our website or contact our Customer Care Line for information on compatible handsets.

Entering Text on Your Phone

When you want to enter text into your phone (for example, a name in the phonebook), use the twelve-key dial pad to enter the letters printed on the number keys. Here's how it works:

- ◆ The phone enters the letters in the order they appear on the key. For example, if you press the number key **2** once, the phone enters the letter **A**. Press **2** twice for **B**, and three times for **C**.
- ◆ If you press the key again after the last letter, the phone starts the same letter sequence with small letters. If you press **2** four times in a row, the phone enters **a** (small letter). Press **2** five times for **b**, and six times for **c**.
- ◆ If you see the icon **[Aa]** in the display, the phone enters capital letters first (**A B C**), then small letters (**a b c**), then the number on the key (**2**). The icon **[aA]** means the phone starts at the small letters, so it enters small letters first, then the number on the key, then capital letters.
- ◆ The phone automatically uses a capital letter for the first letter and any letter directly after a space; all other times, it uses small letters.
- ◆ If two letters in a row use the same number key, enter the first letter, then use **CALLER ID/RIGHT** to move the cursor to the next position to enter the second letter.

Switch between capital letters and small letters	Press * .
Move the cursor	Press PHONEBOOK/LEFT to move the cursor to the left. Press CALLER ID/RIGHT to move the cursor to the right.
Leave a blank space	Press POUND (#) .
Erase one letter	Move the cursor to the letter you want to erase and press CLEAR (CLEAR/INTERCOM on the handset or CLEAR/MUTE on the base.)
Erase the entire entry	Press and hold CLEAR .
Enter punctuation or a symbol	Press 0 to rotate through the available symbols.

Using Your Phone

To...	From the base	From a cordless handset
make a call	Dial the number, then pick up the corded handset.	Dial the number, then press TALK .
answer a call	Pick up the corded handset.	Press TALK .
hang up	Return the handset to the cradle.	Press TALK or just return the handset to the cradle.
mute the microphone during a call	Press CLEAR/MUTE . Press again to turn the microphone back on.	Press MUTE/MESSAGES . Press again to turn the microphone back on.
put a call on hold	Press INTERCOM/HOLD . If you leave a call on hold for 5	Press CLEAR/INTERCOM . minutes, it will be disconnected.
return to a call on hold	Pick up the corded handset. (If it's off the cradle, press TALK .)	Press TALK .
mute the ringer for this call only	While the phone is ringing, press CLEAR/MUTE or PLAY/STOP .	While the phone is ringing, press MUTE/MESSAGES or FLASH/EXIT .

Using the Speakerphone

Both the handset and the base have a speakerphone. To use the base speaker, press **TALK** instead of picking up the corded handset. To use the handset speaker, you can usually just press **SPEAKER** instead of **TALK**.

To...	From the base	From a cordless handset
make a call: Dial the number, then	Press TALK .	Press SPEAKER .
answer a call	Press TALK .	Press SPEAKER .

To...	From the base	From a cordless handset
switch a call to the speakerphone	Press TALK .	Press SPEAKER .
switch back to the earpiece	Pick up the corded handset.	Press SPEAKER .
hang up a speakerphone call	Press TALK .	Press TALK .

Changing the Volume

You can set the volume of the ringer, the earpiece, and the speakerphone separately for the base and each cordless handset. For each item, just press **UP** to make it louder or **DOWN** to make it softer.

The available volume levels and how change them are listed below:

Change the	When	On the base	On a handset
ringer volume	the phone is in standby	select <i>Off, Low, Medium, or High</i>	select <i>Off, Low, Medium, or High</i>
earpiece volume	you are on a normal call	choose one of 6 volume levels	choose one of 6 volume levels
speaker volume	you are using the speakerphone for a call or getting messages	choose one of 10 volume levels	choose one of 6 volume levels

If you want to change the volume of Caller ID announcements, change the ringer volume.

Using the Redial List

The phone saves the last 5 numbers you dial on each station. To open the redial list, press **REDIAL/PAUSE**; use **UP** and **DOWN** to scroll through the list. To close the list, press **PHONEBOOK/LEFT**. With the phone in standby, open the list & find the number you want. Then:

to redial the selected number	On the handset, press TALK ; on the base, pick up the corded handset.
to delete the number	Press SELECT/MENU and select <i>Delete Entry</i> .
to save it to the phonebook	Press SELECT/MENU and select <i>Store Into Pb</i> .

Using Caller ID and Call Waiting

You have to subscribe to Caller ID, Call Waiting, and Caller ID on Call Waiting services to use the features described in this section: contact your telephone provider for more information.

When a call comes in, the phone displays the caller's number & name (if available); if you turned on Text-To-Speech, it also announces the name.

The phone saves the information for the last 30 received calls to the *CID list*. When it's in standby, the phone displays how many new calls you've received since the last time you checked the CID list.

Open the CID list	Press CALLER ID/RIGHT .
Scroll through the CID list	Press DOWN to scroll through the list from newest to oldest. Press UP to scroll from oldest to newest.
Close the CID list	Press PHONEBOOK/LEFT .

Dialing from the Caller ID list

- 1) Find the entry you want to dial.
- 2) If the number is a toll or long distance call, but there's no *1* at the front of the CID record, press **★** to add the *1*.
- 3) On the handset, press **TALK** to dial the number. On the base, pick up the corded handset.

(You can also press **TALK** or pick up the corded handset before opening the CID list. Find the number you want to dial, then press **SELECT/MENU**.)

Caller ID menu options

With the phone in standby, open the CID list and find the number you want. Press **SELECT/MENU** to open the Caller ID menu; choose one of these options:

<i>Delete Entry</i>	Erase this Caller ID number.
<i>Store Into Pb</i>	Add this number to this station's phonebook. The station will prompt you to enter the name and edit the phone number; cordless handsets also prompt you to choose a personal ring.
<i>Delete All</i>	Erase this station's CID list. (This does not affect the CID lists saved on any other stations.)

Using Call Waiting

If you get a Call Waiting call, the phone can sound a tone and display any CID information received for the waiting call. Press **FLASH** (**FLASH/EXIT** on a cordless handset) to switch between your current call and the waiting call; remember, each time you switch, there is a short pause before you're connected to the other caller.

Using Seven-Digit Dialing

If you can make a local call by dialing only seven digits instead of ten, you can tell the phone to hide your local area code in the Caller ID list.

- 1) Open the menu and select *Global Setup*, then select *Area Code*.
 - 2) Use the number keypad (0 - 9) to enter your three-digit area code.
 - 3) Press **SELECT/MENU** when you're finished.
- ◆ The phone uses the programmed code as a filter. When calls come in, the phone compares the received area code to the programmed one. If they match, the phone hides the area code in the Caller ID list.
 - ◆ When you are reviewing the Caller ID list, press **POUND (#)** to toggle the hidden area code.
 - ◆ Remember, when you dial a Caller ID record or store it in the phonebook, the phone dials or stores the digits exactly as they appear on the display. If you need to use ten digits, press **POUND (#)** to show the area code before you dial or store the number.

Using the Phonebook

Each station can store up to 70 entries in its phonebook.

Open or close the phonebook	Press PHONEBOOK/LEFT .
Scroll through the entries	Press DOWN to scroll through the phonebook from A to Z or UP to scroll from Z to A.
Jump to entries that start with a certain letter	Press the number key corresponding to the letter you want to jump to.
Dial an entry	<ol style="list-style-type: none"> 1. Find the entry you want to dial. 2. On the handset, press TALK. On the base, pick up the corded handset.

Phonebook menu options

Open the phonebook with the phone in standby, then press **SELECT/MENU** to open the phonebook menu. Choose one of these options:

<i>Create New</i>	Add an entry to your phonebook. The phone will prompt you to enter the name and phone number. (Cordless handsets will also prompt you to choose a personal ring.)
<i>Copy All</i>	Copy the whole phonebook to another station. (You must have at least one accessory handset to use this multi-station feature.)
<i>Delete All</i>	Erase all the entries in this station's phonebook. (This does not affect the entries saved on any other stations.)

Phonebook entry options

With the phone in standby, open the phonebook and find the entry you want. Press **SELECT/MENU** to open the individual phonebook entry menu. Choose one of these options:

<i>Edit</i>	Edit this entry. The phone will prompt you to enter the name and phone number. (Cordless handsets will also prompt you to choose a personal ring.)
<i>Copy</i>	Copy this entry to another station. (You must have at least one accessory handset to use this multi-station feature.)
<i>Delete</i>	Erase this entry.

Chain Dialing

- ◆ If you often have to enter a series of digits or a code number during a call, you can save that code number to a phonebook entry and use the phonebook to send the code number.
- ◆ Enter the code number (up to 20 digits) into the phonebook just like a regular phonebook entry. Be sure to enter the code number into the phonebook exactly as you would enter it during a call.
- ◆ When you hear the prompt that tells you to enter the number, open the phonebook and find the entry that contains your code number. Press **SELECT/MENU** to transmit the code. The phone transmits the code number exactly as you entered it in the phonebook.

Finding a Lost Handset

With the phone in standby, press **INTERCOM/HOLD** on the base. Select the handset you want to find, or select *All* to page all handsets at the same time. The paged handset(s) will beep for one minute, or until you press **INTERCOM/HOLD** again or press **TALK** and then **FLASH/EXIT** on the handset.

Using an Optional Headset

You can use a standard 2.5 mm telephone headset with your cordless handsets. To purchase headsets, contact the Parts Department (see the front cover).

- ◆ To install a headset, remove the headset jack cover and insert the headset plug into the jack.
- ◆ Just make and receive calls as usual, and use your headset to talk to the caller after the call connects.
- ◆ When you connect a headset, the handset automatically mutes the earpiece and speaker. To re-activate the earpiece or speaker, just unplug the headset.

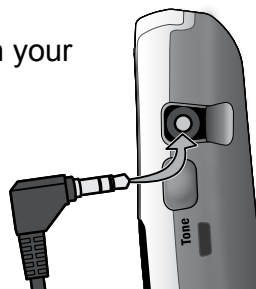

Using Multi-station Features

The expandable base works together with the accessory handsets to give you some useful multi-station features. (A station can be any cordless handset or the base.) You must have at least one accessory handset to use the features in this section.

Expanding Your Phone

- ◆ Your base supports a total of six EZX290 accessory handsets, including any that were supplied with your phone.
- ◆ Your phone may be compatible with other Uniden accessory handsets. Please visit our website for a list of compatible handsets for your base.
- ◆ Accessory handsets must be registered to the base before you can use them. Handsets that have not been registered display a *Handset not registered* message. See page 29 for instructions on registering handsets to this base, or see the manual for the accessory handset.
- ◆ Any accessory handsets that came packaged with the base are already registered to that base for you.
- ◆ If a handset was previously registered to a base, you have to reset it so you can register it to a new base (see page 29 for EZX290 handsets).

Using Conference Calling

When an outside call comes in, the base and two cordless handsets can join in a conference call with the outside caller. To join the call, just pick up the corded handset from the base or press **TALK** on a cordless handset. To leave the conference call, hang up normally; the other station remains connected to the call. (You can also use the speakerphone for a conference call, just like you can with a normal call.)

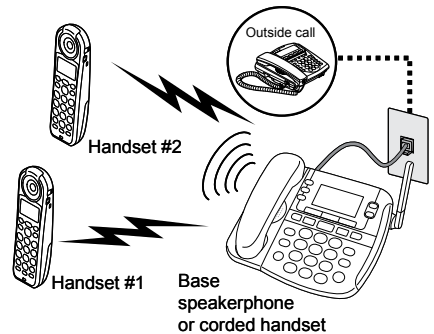

Using Privacy Mode

You can prevent other stations from joining a call. Start your call as usual, then press **SELECT/MENU**: the display shows *Call Privacy*. Press **SELECT/MENU** again to turn privacy mode on (you'll see a  in the display). When you hang up this call, privacy mode turns off automatically.

As long you have privacy mode on, no other stations can interrupt your call. If you want to let another station join the call, turn privacy mode off. To turn it off, just repeat the process above (press **SELECT/MENU** twice).

Using Call Transfer

You can transfer an outside call to any other station.

To...	From the base	From a cordless handset
transfer a call	<ol style="list-style-type: none"> 1. Press INTERCOM/HOLD to put the call on hold. 2. Select the station you want to transfer the call to (select <i>A//</i> to page all the stations). <p>When the other station accepts the call, you'll be disconnected, but you can join the call again.</p>	<ol style="list-style-type: none"> 1. Press CLEAR/INTERCOM to put the call on hold.
cancel a transfer and return to the call	Press TALK .	Press TALK .
accept a transferred call	<ol style="list-style-type: none"> 1. Pick up the corded handset to answer the page and speak to the transferring station. 2. To accept the call, press TALK. 	<ol style="list-style-type: none"> 1. Press CLEAR/INTERCOM to answer the page and speak to the transferring station.

Using the Intercom

Here are some general things you need to know about using the intercom:

- ◆ Whenever the phone is in standby, you can make an intercom call between stations without using the phone line.
- ◆ You can make an intercom call from any station, but only two stations can be in an intercom call at any time.
- ◆ If an outside call comes in during an intercom call, the phone displays the Caller ID information. If the other station hasn't answered the page, the phone cancels the page so you can answer the incoming call.

To...	From the base	From a cordless handset
make an intercom page	<ol style="list-style-type: none"> 1. Press INTERCOM/HOLD. 2. Select the station you want to talk with (select <i>A//</i> to page all the stations). 	<ol style="list-style-type: none"> 1. Press CLEAR/INTERCOM.
cancel a page	Press INTERCOM/HOLD .	Press FLASH/EXIT .
answer an intercom page	Press INTERCOM/HOLD or pick up the corded handset.	Press CLEAR/INTERCOM or TALK .
leave an intercom call	Press INTERCOM/HOLD .	Press FLASH/EXIT .
answer an outside call during an intercom call	Press TALK .	Press TALK .

Using Special Features

Using Your Phone During a Power Failure

Because your phone combines a corded handset with a cordless phone, it can perform several of its functions during a power failure. The following features will operate during a power failure (all other features are disabled):

- ◆ Making and receiving calls with the base corded handset
- ◆ Corded handset volume control
- ◆ Call Waiting on a base corded handset call
- ◆ Entering pauses when dialing from the base corded handset

While the power is out, the base uses a special ringer; you cannot adjust the volume of this ringer.

Using Do Not Disturb

- ◆ The *Do Not Disturb* or *DND* feature turns off the audio ringers of the base & all handsets at the same time. It doesn't affect the visual ringers.
- ◆ With the phone in standby, press and hold **DO NOT DISTURB** on the base. The phone automatically turns on the answering system and shows *Do Not Disturb* in the display on all stations.
- ◆ To cancel, press **DO NOT DISTURB**.

If you turn the answering system off while DND is on, the phone turns off DND along with the answering system.

Adjusting the Base Visual Ringer

The **VISUAL RINGER** switch is at the top of the base (above the cradle); use this switch to change the brightness of the base visual ringer. (It doesn't affect the audio ringers.)

Slide the switch so that its center (marked with the arrow in the picture) lines up with the brightness you want to use: **HIGH**, **LOW**, or **OFF**.

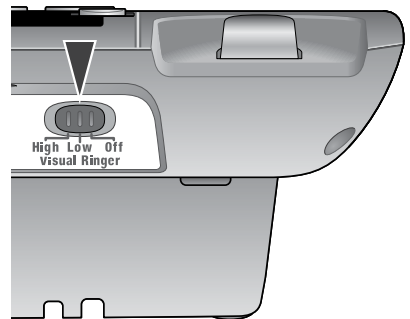

Using the Audio Boost

You can increase the earpiece volume for normal calls and intercom calls. During a call, press **BOOST** to increase the volume of the audio. While audio boost is on, **B** appears in the display. Press **BOOST** again to turn off.

Using Text-To-Speech

With the Text To Speech (TTS) feature, your phone can announce phone numbers or names in several different situations.

When you... (from standby)	The phone announces...
Receive a call	The caller's name (if sent by a Caller ID service)
Dial a number	The phone number you dialed
Open the phonebook	The name of the entry you are looking at

Things to know about TTS:

- ◆ You have to turn on TTS separately for each station. Open the menu and select *Handset Setup* or *Base Setup*. Then, select *TTS On/off*, and select *On* or *Off* for each station.
- ◆ To make sure it doesn't interrupt a call or an intercom page, the phone only uses TTS when it starts out in standby. For example, if you open the phonebook during a call, the phone won't announce the names in your phonebook.
- ◆ It takes at least 2 rings for the phone to receive Caller ID information and announce it. If the phone is answered before the end of the second ring, the phone won't have time to announce the name of the caller.
- ◆ To change the volume used for Caller ID announcements, change the ringer volume. To change the volume for all other TTS features, change the speaker volume.
- ◆ The TTS feature only uses English to announce the name and numbers, regardless of what language is use for the display or the answering system prompts.

Using Voice Message Notification

This feature supports Frequency-Shift Keying (FSK) message notification. Contact your voice mail provider for more details.

If you subscribe to a voice mail service, your phone can notify you when you have a new message waiting. When you have new messages, the voice message icon () appears in the display.

Resetting the voice message indicator

If the voice message icon won't go away after you check your messages, you can reset it. From the base, open the menu, and select *Global Setup*. Select *VMWI Reset*, and select *Yes* to reset the indicator.

Using the Answering System

Setting Up Your Answering System

Recording your outgoing message

Your personal outgoing message or greeting can be between 2 seconds and 30 seconds long. If you don't want to record an outgoing message, the system will use its pre-recorded greeting:

Hello, no one is available to take your call. Please leave a message after the tone.

To record your greeting:

From the base	From a cordless handset
<ol style="list-style-type: none">1. Open the menu and select <i>Ans. Setup</i>.2. Select <i>Record Greeting</i>.3. Press SELECT/MENU again. Wait for the system to say "Record greeting," then begin speaking.4. When you're finished, press PLAY/STOP. The system plays back your new greeting.5. To keep this greeting, press PLAY/STOP. To re-record it, go back to step 2.	<ol style="list-style-type: none">1. Press MUTE/MESSAGES to access the answering system. Wait until the system finishes its announcements, or press 5 (STOP) to skip them.2. Press 8.3. Wait for the system to say "Record greeting," then begin speaking.4. When you're finished, press 8 to stop recording. The system plays back your new greeting.5. To keep this greeting, press FLASH/EXIT. To re-record it, go back to step 2.

Switch between the pre-recorded greeting and your own greeting

From the base	From a cordless handset
<ol style="list-style-type: none">1. Open the menu and select <i>Ans. Setup</i>.2. Select <i>Greeting Options</i>. The system plays back the greeting it is currently using.3. Press REPEAT or SKIP to switch greetings.	<ol style="list-style-type: none">1. Press MUTE/MESSAGES to access the answering system. Wait until the system finishes its announcements, or press 5 (STOP) to skip them.2. Press 6. The system plays back the greeting it is currently using.3. Press 6 again to switch greetings.

Delete your greeting

From the base	From a cordless handset
<ol style="list-style-type: none">1. Switch to your personal greeting following the steps above.2. While the system is playing back your greeting, press DELETE.	<ol style="list-style-type: none">1. Switch to your personal greeting following the steps above.2. While the system is playing back your greeting, press 4.

Ans. Setup menu options

You can change the answering system options from any station. Just open the menu and select *Ans. Setup*.

<i>Record Greeting</i>	(Base only) Record an outgoing message (see page 22)
<i>Greeting Options</i>	(Base only) Change greetings or delete your personal greeting (see page 22).
<i>Security Code</i>	Enter a 2-digit PIN so you can access your answering system from any touch-tone phone (see page 25).
<i>Ring Time</i>	Set the number of rings (2, 4, or 6) before the answering system answers the phone. Choose <i>Toll Saver (TS)</i> to have the system pick up after 2 rings if you have new messages or after 4 rings if you don't.
<i>Record Time</i>	Set the amount of time callers have to leave a message, either 1 minute or 4 minutes. Choose <i>Announce Only</i> if you don't want the system to let callers to leave a message.
<i>Message Alert</i>	Have the system beep every 15 seconds when you have a new message; the beeping stops when you listen to all your new messages. (To mute the alert without listening to your messages, press any key on the base.)
<i>Ans. Language</i>	Change the language of the system's voice prompts.
<i>Call Screen</i>	Turn on the call screen feature so you can hear callers as they leave messages on the base speaker (see page 24).
<i>Ans. On/off</i>	(Handset only) Turn your answering system on or off. (To turn your system on or off from the base, just press ON/OFF.)

Getting Your Messages

Accessing your answering system from a handset

You can access your system from a cordless handset whenever the phone is in standby.

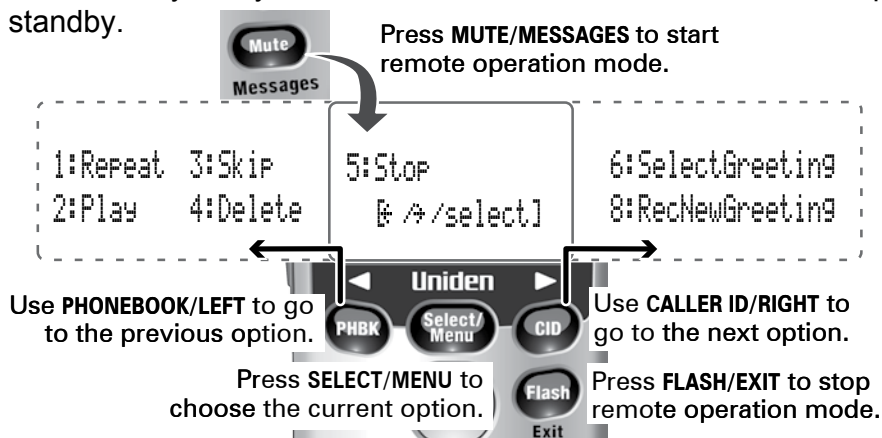

- ◆ During remote operation, the phone beeps to let you know it's waiting for your next command.
- ◆ You can press the number key next to the commands instead of scrolling through them.
- ◆ If you don't press any keys for 30 seconds, the phone returns to standby.

How to operate your answering system

To...	From the base	From a handset (remote operation)
play new messages	Press PLAY/STOP The system announces the number of new and old messages, then plays the first new message followed by the day and time it was received. Then the system plays the new messages in the order they were received.	Press MUTE/MESSAGES .
restart the current message	Press REPEAT .	Press 1 or select <i>1:Repeat</i> .
replay previous messages	Press REPEAT repeatedly until you hear the message you want to replay.	Press 1 or select <i>1:Repeat</i> repeatedly until you hear the message you want to replay.
skip a message	Press SKIP .	Press 3 or select <i>3:Skip</i> .
slow down message playback	Press SLOW . Press again to return to normal playback speed.	Not available.
delete a message	While the message is playing, press DELETE .	While the message is playing, press 4 or select <i>4>Delete</i>
delete all of your messages	With the phone in standby, press DELETE . When the system asks you to confirm, press DELETE again.	Not available.
play old messages	After the system plays the new messages, press PLAY/STOP again.	press 2 or select <i>2:Play</i> .
end the operation	Press PLAY/STOP .	Press FLASH/EXIT .

Screening Your Calls

Another feature your answering system gives you is *call screening*. While the system is taking the message, you can listen to the caller from a cordless handset or over the base speaker (if you turn on *Call Screen*).

To...	From the base	From a cordless handset
hear the caller leaving a message	Just listen to the caller over the speaker.	Press MUTE/MESSAGES .
answer the call	Pick up the corded handset.	Press TALK .
mute the call screen without answering	Press CLEAR/MUTE .	Press FLASH/EXIT or return the handset to the cradle.

- ◆ If you mute the call screen, the system continues taking the message: it just stops playing through the speaker.
- ◆ Only one cordless handset at a time can screen calls. If another handset is screening the call, the handset beeps and returns to standby.

Using the System While You're Away from Home

You can also operate your answering system from any touch-tone phone. Before you can use this feature, you have to program a security code.

Programming a security code

- 1) With the phone in standby, open the menu from any station.
- 2) Select *Ans. Setup*, then select *Security Code*.
- 3) Use the number keypad to enter a two-digit security code (01 to 99). Press **SELECT/MENU** when you're finished.

Remember to make a note of your new security code!

Dialing in to your system

- 1) Call your telephone number and wait for the system to answer. (If your answering system is off, it will answer after about ten rings and sound a series of beeps instead of your greeting.)
- 2) During the greeting (or beeps), press **0** and **immediately** enter your security code. (You have 3 tries to enter you security code: if you enter it wrong 3 times, the system hangs up and returns to standby.)
- 3) The system announces the current time, the number of messages stored in memory, and a help prompt. Then it starts beeping intermittently to let you know it's waiting for your command.
- 4) When you hear the intermittent beeping, enter a command from the chart to the right.

If you don't press any keys for 15 seconds, the phone will hang up and return to standby.

0-1	Repeat message
0-2	Play message
0-3	Skip message
0-4	Delete message

0-5	Stop playback
0-6	Turn the system on
0-9	Turn the system off
1-0	Hear help prompts

Solving Problems

If you have any trouble with your phone, try these simple steps first. If you still have a question, call our Customer Care Line listed on the front cover.

If...	Try...
No stations can make or receive calls.	<ul style="list-style-type: none"> - Checking the telephone cord connection. - Disconnecting the base AC adapter. Wait a few minutes, then reconnect it.
One cordless handset can't make or receive calls.	<ul style="list-style-type: none"> - Moving the handset closer to the base. - Resetting the handset.
A station can make calls, but it won't ring.	<ul style="list-style-type: none"> - Making sure the ringer is turned on. - Making sure Do Not Disturb is turned off.
I can't make or receive calls while the power is out.	<ul style="list-style-type: none"> - Making sure you are using the corded handset on the base. - Checking the telephone cord connection.
A cordless handset's display won't turn on.	<ul style="list-style-type: none"> - Charging the battery for 15-20 hours. - Checking the battery pack connection.
A cordless handset is not working.	<ul style="list-style-type: none"> - Checking the battery pack connection. - Charging the battery for 15-20 hours. - Resetting the handset.
A cordless handset says <i>Unavailable</i> .	<ul style="list-style-type: none"> - Moving the handset closer to the base. - Seeing if another station has Privacy Mode on. - Making sure the base is plugged in.
No stations will display any Caller ID information.	<ul style="list-style-type: none"> - Letting incoming calls ring at least twice before answering. - Seeing if the call was placed through a switchboard. - Checking with your telephone service provider to make sure your Caller ID service is active.
Caller ID displays briefly and then clears.	<ul style="list-style-type: none"> - You may have to change the line mode. Contact customer service for more information.
Caller ID displays, but I can't hear the CID announcements.	<ul style="list-style-type: none"> - Making sure TTS (Text-To-Speech) is turned on. - Increasing the ringer volume so the CID announcements are louder.
I can't transfer calls.	<ul style="list-style-type: none"> - Resetting all the handsets.
I can't get two cordless handsets to talk to the caller.	<ul style="list-style-type: none"> - Making sure both handsets are registered to this base. - Making sure no station is in Privacy Mode.

If...	Try...
The phone keeps ringing when I answer on an extension.	- You may have to change the line mode. Contact customer service for more information.
The answering system does not work.	- Making sure the answering system is turned on. - Making sure the base AC adapter is plugged into a continuous wall outlet (i.e., not controlled by a wall switch).
The answering system won't record messages.	- Making sure the <i>Record Time</i> is not set to <i>Announce Only</i> . - Deleting saved messages (the memory may be full).
My outgoing message is gone.	- Seeing if there was a power failure. You may have to re-record your personal outgoing message.
I can't hear the base speaker.	- Making sure call screening is turned on. - Changing the base speaker volume.
Messages are incomplete.	- The incoming messages may be too long. Remind callers to leave a brief message. - Deleting saved messages (the memory may be full).
The answering system keeps recording when I answer on an extension.	- You may have to change the line mode. Contact customer service for more information.
I can't register a handset.	- Seeing if you already have 6 handsets registered to this base. - Resetting the handset.

Weak or Hard To Hear Audio

If a caller's voice sounds weak or soft, the signal might be blocked by large metal objects or walls; you might also be too far from the base, or the handset's battery may be weak.

- ◆ Try moving around while you're on a call or moving closer to the base to see if the sound gets louder.
- ◆ Make sure the handset's battery is fully charged.
- ◆ Try adjusting the volume of the earpiece or the audio tone (see below).

Adjust the audio tone

During a call, press **TONE** to cycle through the three audio tone options: *High Tone*, *Natural Tone* (recommended for hearing aid users), or *Low Tone*. (The tone setting appears in the display as you do this.) You may have to experiment to figure out which audio tone works best for you.

Noise or Static On The Line

The most common cause of noise or static on a cordless phone is interference. Here are some common household sources of interference:

- ◆ electrical appliances, especially microwave ovens
- ◆ computer equipment, especially wireless LAN equipment and DSL modems
- ◆ radio-based wireless devices, such as room monitors, wireless controllers, or wireless headphones or speakers
- ◆ large florescent light fixtures (especially if they give off a buzzing noise)
- ◆ other services that use your phone line, like alarm systems, intercom systems, or broadband Internet service

Here are some hints for when the static is...

on 1 handset or in 1 location:	on all handsets or in all locations:
<ul style="list-style-type: none">- Check nearby for one of the common interference sources.- Try moving the handset away from a suspected source, or try moving the suspected source so it's not between the handset and the base.- Try moving closer to the base. There is always more noise at the edges of the base's range. If the handset displays an <i>Out of Range</i> message, you need to move closer to the base.	<ul style="list-style-type: none">- Check near the base for the source of interference.- Try moving the base away from a suspected source, or turn off the source if possible.- If the base has an adjustable antenna, try raising the antenna so it stands straight up.- If you have any service that uses the phone line, you might need a filter (see below).

Installing a telephone line filter or DSL filter

Sometimes, broadband Internet services that use the telephone line can interfere with phones. One of these services—DSL—often causes static on telephones. A DSL filter or telephone line filter usually solves this problem. The technician who installed

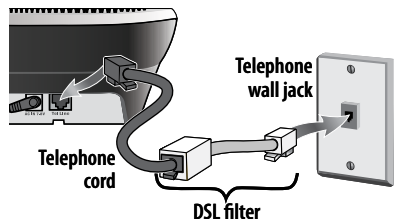

Do you have a T-Coil hearing aid?

If you have a hearing aid equipped with a telecoil (T-coil) feature, the interaction between the hearing aid and digital cordless phones can cause noise in the handset. If you have a T-coil hearing aid and you have problems with noise on the line, try turning on *T-coil* mode. Open the menu. Select *Handset Setup*, then select *T-coil*.

Using T-coil mode can shorten the handset's talk time; make sure to watch your battery status and keep the battery charged.

your DSL service might have left some filters for you; if not, call your DSL provider or look in any electronics store.

Plug the DSL filter into the telephone wall jack and then plug your phone's base into the filter. Make a test call to make sure the noise is gone.

Resetting and Registering Handsets

If you are having trouble with a cordless handset or if you want to replace one, you need to clear the registration information from the base and the handset:

Do you have the base the handset is registered to?	
Yes	No
<ol style="list-style-type: none"> 1. Press and hold FLASH/EXIT and POUND (#) until the <i>System Reset</i> menu appears (about 5 seconds). 2. Select <i>Deregister HS</i>. The display lists all registered handsets. 3. Select the handset you want to reset. 4. When the phone asks you to confirm, select <i>Yes</i>. The handset clears its information from the base and deletes its own link to the base. 	<ol style="list-style-type: none"> 1. Press and hold FLASH/EXIT and POUND (#) until the <i>System Reset</i> menu appears (about 5 seconds). 2. Select <i>Base Unavailable</i>. 3. When the phone asks you to confirm, select <i>Yes</i>. The handset deletes its own link without contacting the base.

When you reset a handset (or if you purchase a new one), that handset displays a *Handset Not Registered* message. If you see this message on a handset, you need to register it to a base before you can use it.

Registering a handset

- 1) On the base, open the menu and select *Register Handset*. The display should say *Handset Registering*.
- 2) On the handset you want to register, press and hold **POUND (#)** until the handset display says *Handset Registering* (about 2 seconds).
- 3) In about 30 seconds, the handset display should say *Registration Complete*. Press **TALK** and make sure you get a dial tone.

If...	Try...
- you don't hear a dial tone - the display says <i>Registration Failed</i>	Making sure the handset is fully charged, then start over at step 1.

To register a handset to a different base, see the section "Expanding Your Phone" in the user's guide for the other base.

Handling Liquid Damage

Moisture and liquid can damage your cordless phone.

- ◆ If the handset or base is exposed to moisture or liquid, but only the exterior plastic housing is affected, wipe off the liquid, and use as normal.
- ◆ If moisture or liquid has entered the plastic housing (i.e. liquid can be heard in the phone or liquid has entered the handset battery compartment or vent openings on the base), follow the steps below:

Handset	Base
<ol style="list-style-type: none">1. Remove the battery cover and leave it off for ventilation.2. Disconnect the battery pack. Leave the battery cover off and the battery pack disconnected for at least 3 days.3. Once the handset is completely dry, reconnect the battery pack and the battery cover.4. Recharge the battery pack for 15-20 hours before using.	<ol style="list-style-type: none">1. Disconnect the AC adapter, cutting off electrical power.2. Disconnect the telephone cord from the base.3. Let dry for at least 3 days.

IMPORTANT: You must unplug the telephone line while recharging the battery pack to avoid charge interruption.

CAUTION! DO NOT use a microwave oven to speed up the drying process. This will cause permanent damage to the handset, base and the microwave oven.

Important Information

Terms Used In This Guide

Accessory Handset	An extra handset that can register to and be used with an expandable phone base. All accessory handsets must be registered to a base.
Base	The main part of the phone. It connects to your phone line and lets you make and receive calls. Most bases also have a cradle to store a handset.
CIDCW	(CID on Call Waiting.) A service that shows CID for calls that come in during another call.
Call Waiting	A service that lets you receive calls while you are on another call.
Caller ID	(Also called CID.) A service that shows the name and number of incoming callers.
Charger	A cradle that stores and charges a handset but doesn't connect to the phone line.
Cradle	The part of the phone that stores a handset. While in a cradle, a handset is always in standby, and any keys are locked.
During a call	The station is currently on a call or has activated a dial tone.
Handset	1) A cordless handset that you use to dial the phone and talk to callers. 2) A corded handset that attaches to a base with a coiled cord.
In standby	The phone is inactive at the moment: there is no dial tone, no station is on a call or listening to messages.
Station	Any handset or the base.
TTS	(Text to speech) A technology that reads data in a synthesized voice. TTS is used to announce incoming CID information, read numbers from the phonebook, etc.

Specifications

	Base	Charger
AC adapter	Part number	PS-0034
	Input voltage	120V AC, 60 Hz
	Output voltage	7.8V AC @ 450mA
Battery pack	Part number	BT-1007
	Capacity	500mAh, 2.4V DC

- ♦ Use only the supplied AC adapters.
- ♦ Be sure to use the proper adapter for the base and any chargers.
- ♦ Do not place the power cord where it creates a trip hazard or where it could become chafed and create a fire or electrical hazard.
- ♦ Do not place the base in direct sunlight or subject it to high temperatures.

Battery Information

- ♦ Fully charged, the battery should provide about 10 hours of talk time and about 7 days of standby time. For best results, return the handset to the cradle after each call to keep it fully charged.
- ♦ Keep an eye on the battery status icon. When the battery gets too low, the handset shows a low battery alert. If you hear a strange beep during a call, check the display: if you see the low battery alert, finish your conversation as quickly as possible and return the handset to the cradle. If the handset is in standby, none of the keys will operate.
- ♦ With normal use, the battery should last about one year. Replace the battery when the talk time becomes short even when the battery is charged. To buy a replacement battery, call the Parts Department listed on the front cover.

Rechargeable Nickel-Cadmium Battery Warning

***CAUTION! Risk of explosion if battery is replaced by an incorrect type!
Dispose of used batteries according to the instructions. Do not open or
mutilate the battery. Disconnect the battery before shipping this product.***

- ♦ This equipment contains a rechargeable nickel-cadmium (Ni-Cd) battery.
- ♦ Cadmium and Nickel are chemicals known to the State of California to cause cancer.

- Do not short-circuit the battery.
- The rechargeable Ni-Cd battery contained in this equipment may explode if disposed of in a fire.
- Do not charge the battery used in this equipment in any charger other than the one designed to charge this battery as specified in the owner's manual. Using another charger may damage the battery or cause it to explode.
- As part of our commitment to protecting our environment and conserving natural resources, Uniden voluntarily participates in an RBRC® industry program to collect and recycle used Ni-Cd batteries within the United States. Please call 1-800-8-BATTERY for information on Ni-Cd battery recycling in your area. (RBRC® is a registered trademark of the Rechargeable Battery Recycling Corporation.)



Rechargeable Batteries Must Be Recycled or Disposed of Properly.

Uniden works to reduce lead content in PVC coated cords in our products & accessories.

Warning! The cords on this product and/or accessories contain lead, a chemical known to the State of California to cause birth defects or other reproductive harm. Wash hands after handling.

Compliance information

FCC Part 68 information

This equipment complies with Part 68 of the FCC rules & the requirements adopted by the ACTA. On the bottom of this equipment is a label that contains, among other information, a product identifier in the format US: AAAEQ##TXXXX. If requested, this number must be provided to the phone company.

An applicable Universal Service Order Codes (USOC) certification for the jacks used in this equipment is provided (i.e., RJ11C) in the packaging with each piece of approved terminal equipment. A plug & jack used to connect this equipment to the premises wiring & telephone network must comply with the applicable FCC Part 68 rules & requirements adopted by the ACTA. A compliant telephone cord & modular plug is provided with this product. It is designed to be connected to a compatible modular jack that is also compliant. See installation instructions for details.

The REN is used to determine the number of devices that may be connected to a phone line. Excessive RENs on a phone line may result in devices not ringing in response to an incoming call. In most but not all areas, the sum of RENs should not exceed five (5.0). To be certain of the number of devices that may be connected to a line, as determined by the total RENs, contact the telephone provider. The REN for this product is part of the product identifier that has the format US: AAAEQ##TXXXX. The digits represented by ## are the REN without a decimal point (e.g., 03 is a REN of 0.3).

If this equipment causes harm to the telephone network, the telephone company will notify you in advance that temporary discontinuance of service may be required. But if advance notice isn't practical, the telephone company will notify the customer as soon as possible. Also, you will be advised of your right to file a complaint with the FCC if you believe it is necessary. The telephone company may make changes in its facilities, equipment, operations or procedures that could affect the operation of the equipment. If this happens the telephone company will provide advance notice in order for you to make necessary modifications to maintain uninterrupted service.

Please follow instructions for repairing, if any (e.g. battery replacement section); otherwise do not substitute or repair any parts of the device except as specified in this manual. Connection to party line service is subject to state tariffs. Contact the state public utility commission, public service commission or corporation commission for information. This equipment is hearing aid compatible.

If you experience trouble with this equipment, contact the manufacturer (see the cover of this manual for contact information) or an authorized agent. If the equipment is causing harm to the telephone network, the telephone company may request that you disconnect the equipment until the problem is resolved.

If your home has wired alarm equipment connected to a phone line, be sure that installing the system does not disable your alarm equipment. If you have questions about what will disable alarm equipment, contact your telephone company or a qualified installer.

Any changes or modifications to this product not expressly approved by the manufacturer or other party responsible for compliance could void your authority to operate this product.

NOTICE: According to telephone company reports, AC electrical surges, typically resulting from lightning strikes, are very destructive to telephone equipment connected to AC power sources. To minimize damage from these types of surges, a surge arrester is recommended.

FCC Part 15 information

This device complies with part 15 of the FCC rules. Operation is subject to the following two conditions: (1) This device may not cause harmful interference, & (2) This device must accept any interference received, including interference that may cause undesired operation. Privacy of communications may not be ensured when using this phone.

FCC PART 15.105(b): Note: This equipment has been tested & found to comply with the limits for a Class B digital device, pursuant to part 15 of the FCC Rules. These limits are designed to provide reasonable protection against harmful interference in a residential installation. This equipment generates, uses & can radiate radio frequency energy and, if not installed & used in accordance with the instructions, may cause harmful interference to radio communications. However, there is no guarantee that interference will not occur in a particular installation. If this equipment does cause harmful interference to radio or television reception, which can be determined by turning the equipment off & on, the user is encouraged to try to correct the interference by one or more of the following measures:

- ♦ Reorient or relocate the receiving antenna.
- ♦ Increase the separation between the equipment and receiver.
- ♦ Connect the equipment into an outlet on a circuit different from that to which the receiver is connected.
- ♦ Consult the dealer or an experienced radio/TV technician for help.

This product complies with FCC radiation exposure limits under the following conditions:

- ♦ The base must be placed to allow a minimum of 20 cm (8 inches) between the antenna and all persons during normal operation.
- ♦ The base must not be collocated or operated in conjunction with any other antenna or transmitter.
- ♦ The handset is designed for body-worn operation and meets FCC RF exposure guidelines when used with any belt clip, carrying case, or other accessory supplied with this product. (All necessary accessories are included in the package; any additional or optional accessories are not required for compliance with the guidelines.) Third party accessories (unless approved by the manufacturer) should be avoided as these might not comply with FCC RF exposure guidelines.

Industry Canada (I.C.) Notice

Terminal equipment

NOTICE: This equipment meets the applicable **Industry Canada Terminal Equipment Technical Specifications**. This is confirmed by the registration number. The abbreviation *IC* before the registration number signifies that registration was performed based on a Declaration of Conformity indicating that Industry Canada technical specifications were met. It does not imply that Industry Canada approved the equipment.

NOTICE: The Ringer Equivalence Number (REN) for this terminal equipment is marked on the equipment itself. The REN assigned to each terminal equipment provides an indication of the maximum number of terminals allowed to be connected to a telephone interface. The termination on an interface may consist of any combination of devices subject only to the requirement that the sum of the Ringer Equivalence Numbers of all the devices does not exceed 5.

Radio equipment

The term *IC* before the radio certification number only signifies that Industry Canada technical specifications were met. Operation is subject to the following two conditions: (1) this device may not cause interference, & (2) this device must accept any interference, including interference that may cause undesired operation of the device. "Privacy of communications may not be ensured when using this telephone".

One-year Limited Warranty

Important: Evidence of original purchase is required for warranty service.

WARRANTOR: UNIDEN AMERICA CORPORATION ("Uniden") **ELEMENTS OF WARRANTY:**

Uniden warrants, for one year, to the original retail owner, this Uniden Product to be free from defects in materials & craftsmanship with only the limitations or exclusions set out below.

WARRANTY DURATION: This warranty to the original user shall terminate & be of no further effect 12 months after the date of original retail sale. The warranty is invalid if the Product is (A) damaged or not maintained as reasonable or necessary, (B) modified, altered, or used as part of any conversion kits, subassemblies, or any configurations not sold by Uniden, (C) improperly installed, (D) serviced or repaired by someone other than an authorized Uniden service center for a defect or malfunction covered by this warranty, (E) used in any conjunction with equipment or parts or as part of any system not manufactured by Uniden, or (F) installed or programmed by anyone other than as detailed by the owner's manual for this product.

STATEMENT OF REMEDY: In the event that the product does not conform to this warranty at any time while this warranty is in effect, warrantor will either, at its option, repair or replace the defective unit & return it to you without charge for parts, service, or any other cost (except shipping & handling) incurred by warrantor or its representatives in connection with the performance of this warranty. Warrantor, at its option, may replace the unit with a new or refurbished unit. **THE LIMITED WARRANTY SET FORTH ABOVE IS THE SOLE & ENTIRE WARRANTY PERTAINING TO THE PRODUCT & IS IN LIEU OF & EXCLUDES ALL OTHER WARRANTIES OF ANY NATURE WHATSOEVER, WHETHER EXPRESS, IMPLIED OR ARISING BY OPERATION OF LAW, INCLUDING, BUT NOT LIMITED TO ANY IMPLIED WARRANTIES OF MERCHANTABILITY OR FITNESS FOR A PARTICULAR PURPOSE. THIS WARRANTY DOES NOT COVER OR PROVIDE FOR THE REIMBURSEMENT OR PAYMENT OF INCIDENTAL OR CONSEQUENTIAL DAMAGES.** Some states do not allow this exclusion or limitation of incidental or consequential damages so the above limitation or exclusion may not apply to you.

LEGAL REMEDIES: This warranty gives you specific legal rights, & you may also have other rights which vary from state to state. This warranty is void outside the United States of America & Canada.

PROCEDURE FOR OBTAINING PERFORMANCE OF WARRANTY: If, after following the instructions in the owner's manual you are certain that the Product is defective, pack the Product carefully (preferably in its original packaging). Disconnect the battery from the Product & separately secure the battery in its own separate packaging within the shipping carton. The Product should include all parts & accessories originally packaged with the Product. Include evidence of original purchase & a note describing the defect that has caused you to return it. The Product should be shipped freight prepaid, by traceable means, to warrantor at:

Uniden America Service
4700 Amon Carter Blvd.
Fort Worth, TX 76155

As an Energy Star® Partner, Uniden has determined that this product meets the Energy Star® guidelines for energy efficiency. Energy Star® is a U.S. registered mark.



- Uniden® is a registered trademark of Uniden America Corporation.
- Call waiting, CID, CIDCW, and Voice Mail are telephone line services. Your phone supports these services, but you have to arrange for them through your telephone provider. Contact your provider for details.
- The pictures in this manual are for example only. Your phone may not look exactly like the pictures.

May be covered under one or more of the following U.S. patents:

5,491,745	5,533,010	5,574,727	5,581,598	5,606,598	5,650,790	5,660,269	5,663,981	5,671,248
5,717,312	5,732,355	5,754,407	5,758,289	5,768,345	5,787,356	5,794,152	5,801,466	5,825,161
5,864,619	5,893,034	5,912,968	5,915,227	5,929,598	5,930,720	5,960,358	5,987,330	6,044,281
6,070,082	6,076,052	6,125,277	6,253,088	6,314,278	6,321,068	6,418,209	6,618,015	6,714,630
6,782,098	6,788,920	6,788,953	6,839,550	6,889,184	6,901,271	6,907,094	6,914,940	6,940,867
6,953,118	7,023,176	7,030,819	7,146,160	7,203,307	7,206,403	7,310,398		

Other patents pending.

© 2009 Uniden America Corp.
Ft. Worth, TX 76155

Printed in Vietnam
UNZ01055BA(0)