

TOSHIBA

OWNER'S MANUAL

900MHz CORDLESS TELEPHONE DIGITAL ANSWERING SYSTEM

FT-8981



The **FIRST** thing to do after unpacking your new cordless telephone is:

CHARGE THE BATTERY !

Please read and follow the few instructions on

PAGE 2

BEFORE YOU DO ANYTHING ELSE.

Preparation

Basics

Caller ID/Call waiting

Answering System

Additional Information

GETTING STARTED: DO THIS FIRST!

FIRST, CHARGE THE HANDSET BATTERY!

- **Set your new phone in an out-of-the-way place near a power outlet where it will not be disturbed.**
- Plug the AC adaptor into the wall outlet.
- Plug the AC adaptor cord into the power jack on the base unit.
- Take the cover off the handset battery compartment; plug the battery connector into the receptacle inside the battery compartment and replace the cover. The connector only goes in one way.
- Place the handset into the base unit's charging cradle. The CHARGE LED should light. If not, see TROUBLESHOOTING, page 43.
- The battery charging period has now started. From now until the 12~16 hours period is complete, do not let anything cause the handset to be removed from electrical contact with the base unit's charging pins or power to be removed from the base unit.

SECOND,

- **Before you can take advantage of the Caller ID and Call Waiting features, you must subscribe to these services from your local telephone company.**
- Name and number caller ID only work in conjunction with service provided by your local telephone company.

THIRD, Enter your AREA CODE, see page 16.

INTRODUCTION

FEATURES

Toshiba America Consumer Products, Inc., takes pride in presenting the new 900 MHz cordless telephone and digital answering system. The Toshiba cordless telephone features a 16-digit x 3-line dot matrix liquid crystal display (LCD) for caller ID on Call Waiting and speed dial programming and calling. The sleek new design provides face-up battery charging even when wall mounted. Other features are summarized below.

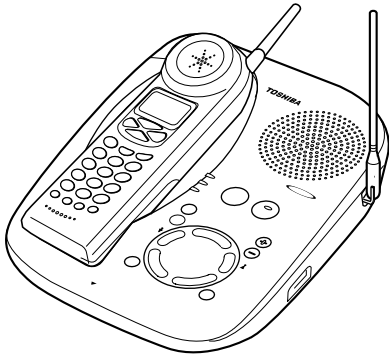

- 900 MHz Analog Transmission with Extended Talk Range
- 40-Channel Auto Scanning
- All Digital Recording System (Approx. 15 min. Recording Time)
- Advanced Compandor Noise Reduction System
- 20 Name & Number Caller ID
- Advanced Message Management Design
- Voice Guidance/Time Stamp
- Long Standby Battery Life (14 days)

- One Way Page/Handset Locator
- Last Number Redial (32 digits)
- 10 Speed-dial (20 digits)
- Any-Key Answer
- Reversible Charging System
- Hearing Aid Compatible/HAC Volume
- Desk/Wall Mountable (Bracket Included)
- Custom Greeting Message/Pre-recorded Greeting Message
- Memo Recording
- Caller ID on Call Waiting
- Backlit 3-Line Alphanumeric LCD Display
- Volume Control (4 Level)
- Ringer Volume and Tone Control
- Digital Security Code (65,536 Codes)

TABLE OF CONTENTS

Preparation

INTRODUCTION	3
Features	3
IMPORTANT SAFETY INSTRUCTIONS	6
LOCATION OF CONTROLS	8
Handset	8
Base unit	9
INSTALLATION	10
Setting up the base unit (Desk top mounting)	10
AC adaptor information	10
Setting up the base unit (Wall mounting)	11
Wall Mount Template	11
Charging the battery pack	12
Setting the dial mode	14
Setting or canceling the Auto Talk function	15
Setting or canceling caller ID on call waiting	15
Setting the area code	16

Basics

BASIC OPERATION	17
Making a call	17
Receiving a call	17
Redial	18
Out of range	18
Call waiting	18
Handset earpiece volume setting	18
Handset ringer volume setting	18
Base speaker volume setting	19
Tone/Pause	19
Interference or static	19
Paging the handset	19
MEMORY DIALING	20
Storing numbers	20
Steps for entering names and special characters	22
If you make a mistake while entering a name	23
Dialing a stored number	23
Editing and deleting stored numbers	24

TABLE OF CONTENTS

Caller ID/Call waiting

CALLER ID/CALL WAITING	.26
Answering a call with caller ID service	.26
Searching caller ID memory	.28
Calling back from the caller ID list	.28
Editing caller ID data	.29
Transferring CID number to speed-dial memory	.29
Deleting caller ID data	.30
Call Waiting	.31

Answering system

USING THE MENU MODE	.32
Recording the greeting message	.33
Changing the greeting message	.33
Setting the clock	.34
Setting the security code (PIN)	.35
Setting the base ringer volume	.35
Setting the number of rings	.36
Setting the recording time	.36
USING THE ANSWERING MACHINE	.37
Turning the answering machine ON & OFF	.37
Checking and switching greeting message	.37
Checking clock setting	.38
Playing recorded messages	.38
Deleting recorded messages	.39
Screening incoming calls	.39
Leaving a memo message	.40
Recording a phone conversation (2 WAY REC)	.40
Calling in from a remote location	.41
Table of commands	.42

Additional Information

TROUBLESHOOTING	.43
WARRANTY/SERVICE	.46
REMOTE OPERATION CARDS	.49

IMPORTANT SAFETY INSTRUCTIONS

When using your telephone equipment, basic safety precautions should always be followed to reduce the risk of fire, electric shock and injury.

- 1 Read and understand all instructions.
- 2 Follow all warnings and instructions marked on the product.
- 3 Unplug this product from the wall outlet before cleaning. Do not use liquid cleaners or aerosol cleaners. Use a dry cloth for cleaning.
- 4 Do not use this product near water sources, such as bath tubs, wash bowls, kitchen sinks, laundry tubs, wet basements, or swimming pools.
- 5 Do not place this product on an unstable cart, stand, or table. The telephone may fall, causing serious damage to the telephone.
- 6 Slots and openings in the cabinet and the back or bottom are provided for ventilation. To protect it from overheating, these openings must not be blocked or covered. The openings should never be blocked by placing the product on a bed, sofa, rug, or other similar surface. This product should never be placed near or over a radiator or heat register. This product should not be placed in a built-in installation unless proper ventilation is provided.
- 7 Do not allow anything to rest on the power cord. Do not locate this product where the cord can be stepped on or tripped over.
- 8 Do not overload wall outlets and extension cords as this can result in the risk of fire or electric shock.
- 9 Never push objects of any kind into this product through cabinet slots as they may touch dangerous voltage points or short out parts that could result in a risk of fire or electric shock. Never spill liquid of any kind on the product.
- 10 Do not disassemble this product. Opening or removing covers puts you at risk of electrical shock, and incorrect reassembly can cause shocks, sparks or other damage during subsequent use.
- 11 Take this product to a qualified service technician under any of the following conditions:
 - A. When the power supply cord is damaged or frayed.
 - B. If liquid has been spilled into the product.
 - C. If the product has been exposed to rain or water.
 - D. If the product does not operate normally according to the operating instructions. Adjust only those controls covered by this manual. Improper adjustment of other controls may result in serious damage to the unit or your home.
 - E. If the product has been dropped or the cabinet has been damaged.
 - F. If the product exhibits a distinct change in performance.
- 12 Do not use the telephone in the vicinity of a gas leak.

IMPORTANT SAFETY INSTRUCTIONS

The RBRC™ Seal



The RBRC™ Seal on the (easily removable) nickel-cadmium battery (contained in our product) indicates that Toshiba America Consumer Products, Inc. (TACP) is voluntarily participating in an industry program to collect and recycle these batteries at the end of their useful lives, when taken out of service within the United States. The RBRC™ program provides a convenient alternative to placing used nickel-cadmium batteries into the trash or municipal waste, which is illegal in some areas. TACP's payments to RBRC™ make it easy for you to drop off the spent battery at local retailers of replacement nickel-cadmium batteries, or at authorized TACP product service centers. You may also contact your local recycling center for information on where to return the spent battery. Please call 1-800-8-BATTER for information on Ni-Cd battery recycling in your area. TACP's involvement in this program is part of its commitment to protecting our environment and conserving natural resources. RBRC™ is a trademark of Rechargeable Battery Recycling Corporation.

CAUTION: TO REDUCE THE RISK OF FIRE OR INJURY TO PERSONS BY THE BATTERY, READ AND FOLLOW THESE INSTRUCTIONS.

BATTERIES

- 1 Use only the appropriate type and size battery pack specified in the instruction manual provided for this product.
- 2 Do not dispose of the battery pack in a fire. The cell may explode. Check with State and local codes for possible special disposal instructions.
- 3 Do not open or mutilate the battery pack. Released electrolytes are corrosive and may cause damage to the eyes or skin. It may be toxic if swallowed.
- 4 Exercise care in handling the batteries. Contact with conductive materials such as rings, bracelets and keys may cause the battery to short out, resulting in overheating which could burn.
- 5 Charge the battery pack provided with or identified for use with this product only in accordance with the instructions and limitations specified in the instruction manual provided for this product.
- 6 Observe proper polarity orientation between the battery pack and the battery charger.

ATTENTION: THE PRODUCT THAT YOU HAVE PURCHASED CONTAINS A RECHARGEABLE BATTERY. UNDER VARIOUS STATE AND LOCAL LAWS, IT MAY BE ILLEGAL TO DISPOSE OF THIS BATTERY INTO THE MUNICIPAL WASTE STREAM. PLEASE CHECK WITH YOUR LOCAL GOVERNMENT FOR DETAILS IN YOUR AREA REGARDING RECYCLING OPTIONS OR PROPER DISPOSAL.

SAVE THESE INSTRUCTIONS

TO HELP PROTECT THE ENVIRONMENT, THIS PRODUCT MAY CONTAIN RECYCLED OR RECONDITIONED PARTS AND MATERIALS.

LOCATION OF CONTROLS

HANDSET

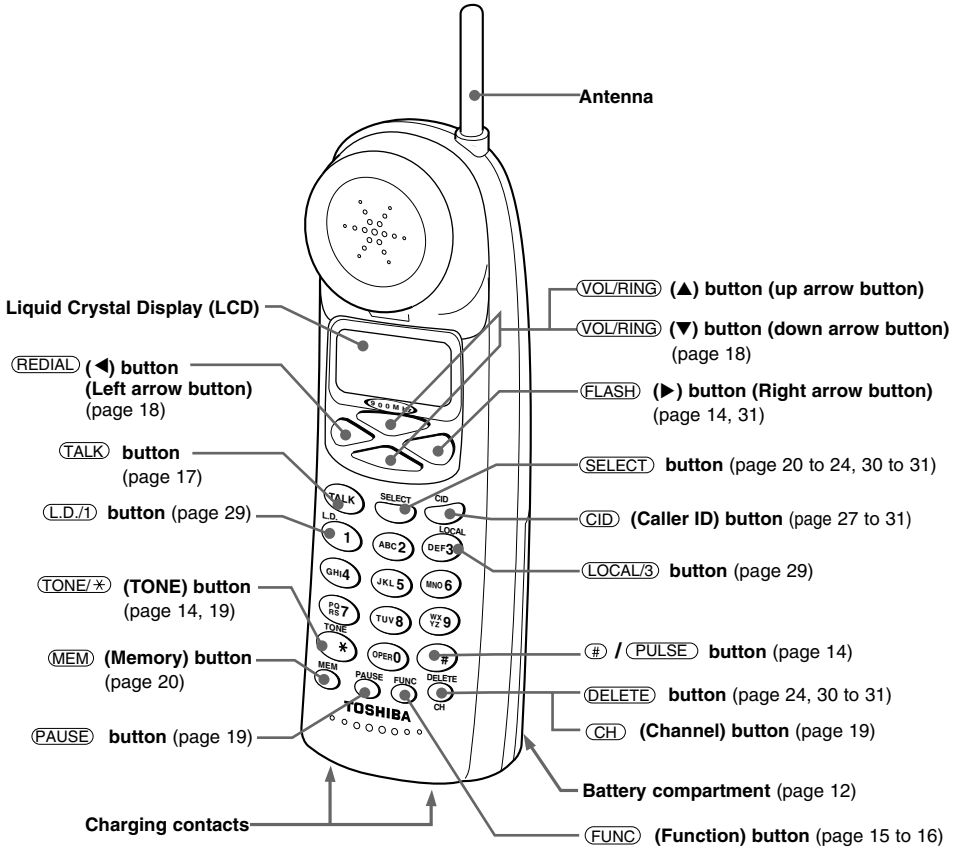

SUPPLIED ACCESSORIES:

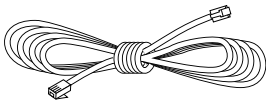

Modular Line Cord
Part # RC008231

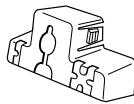

Wall Mount Bracket
Part # RC009245

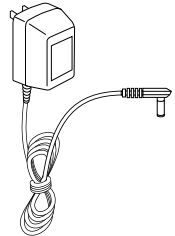

AC Adaptor
TAC-8930
Part # RC009255

LOCATION OF CONTROLS

BASE UNIT

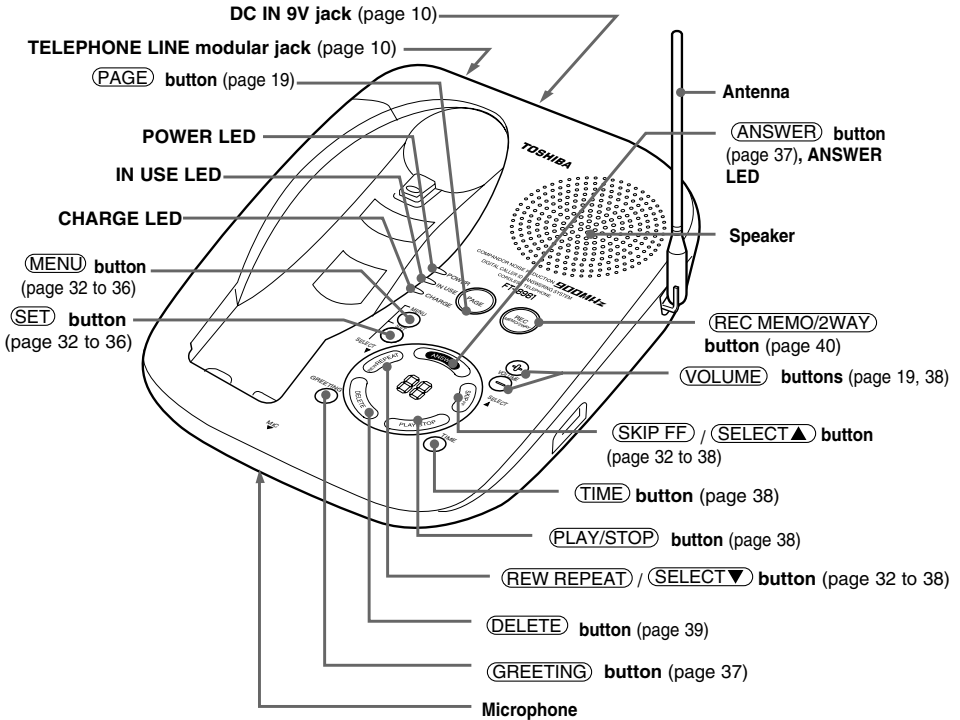

For purchase of accessories, please call 1-877-644-7373.

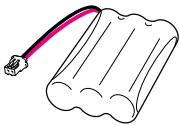

Owner's manual
Part # RC009795

Rechargeable Battery Pack
Toshiba TRB-8000
Part # RC004931

Quick Reference Guide
Part # RC009796

INSTALLATION

SETTING UP THE BASE UNIT (DESK TOP MOUNTING)

For setting up the base unit follow the instructions below.

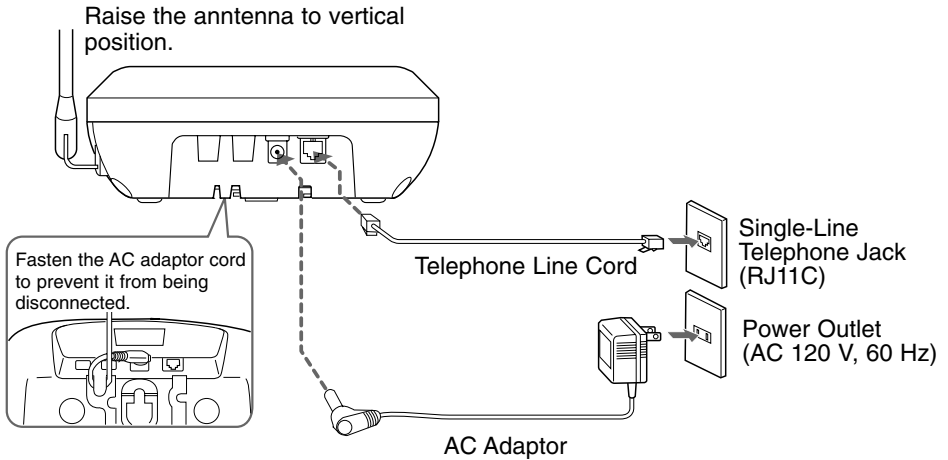

- Plug the AC adaptor firmly into the base unit and the AC 120V outlet.
- **USE ONLY WITH Supplied AC ADAPTOR (TAC-8930 power source AC 120V 60Hz/DC9V).**
- Connect the AC adapter to a continuous power supply.

AC ADAPTOR INFORMATION

Use only the supplied AC adaptor, or one matching its specifications exactly with this product. Incorrect voltage may damage the unit or cause it to function improperly.

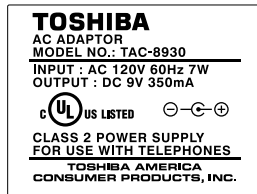

SETTING UP THE BASE UNIT (WALL MOUNTING)

MOUNTING ON A STANDARD WALL PLATE:

Insert the bracket's tabs into the notches on the base.

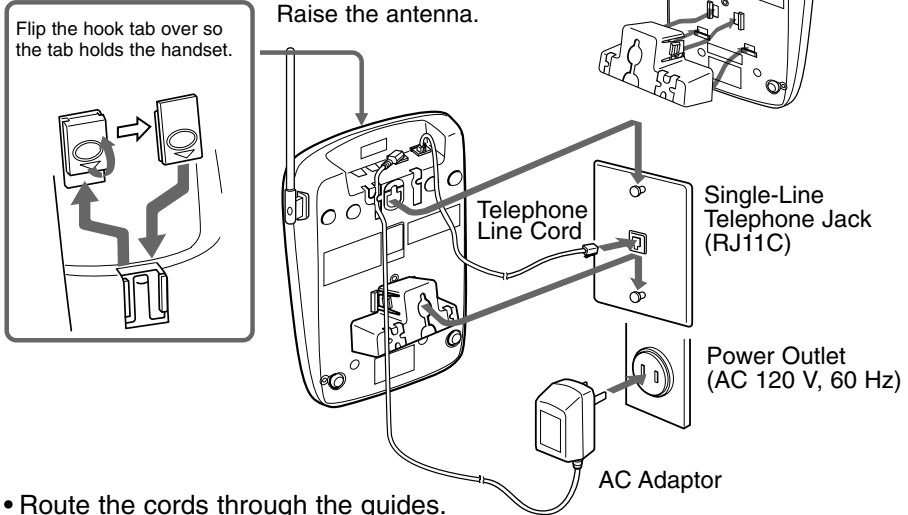

- Route the cords through the guides.
- Place the base unit on the posts of the wall plate and push down until it is firmly seated.

NOTES:

- **Do not use any outlet controlled by a wall switch.**
- **If you don't have a standard wall plate, cut out the template on this page and use it to position two screws (minimum length of $1\frac{3}{8}$ inches) into the wall with the heads protruding about $\frac{1}{4}$ inch.**

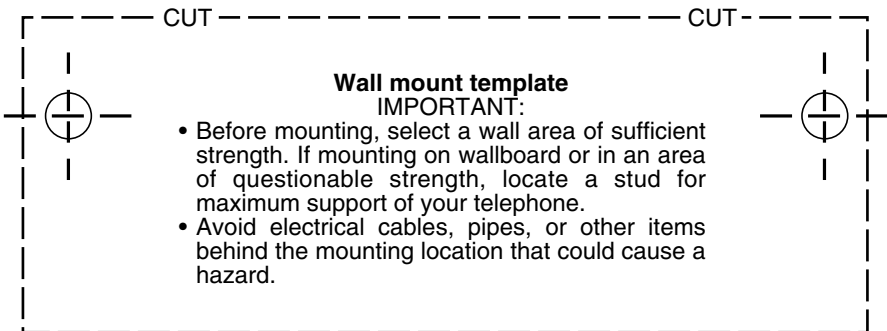

INSTALLATION

CHARGING THE BATTERY PACK

It is important to charge the battery for 12 to 16 hours continuously without any interruption before you use the handset for the first time.

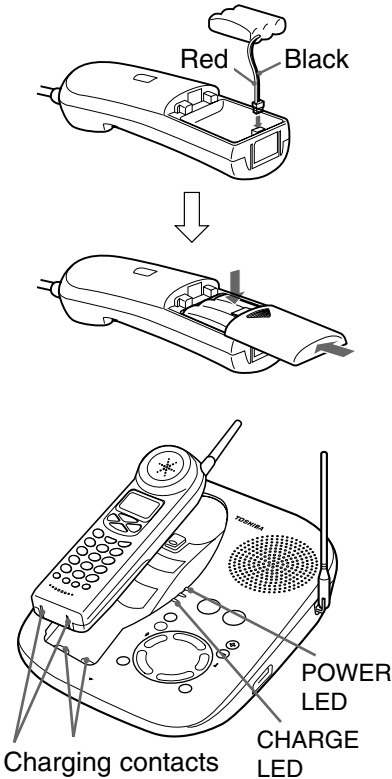

- 1** Remove the battery cover on the back of the handset by sliding it down.
- 2** Plug the battery pack cord into the connector with the correct polarity. (black and red wires).
- 3** Place the battery pack in the battery compartment.
- 4** Put the battery cover back by sliding until it snaps into place. Make sure not to get the wires of the battery pack caught in the cover.
- 5** Place the handset on the base unit. Be sure the CHARGE LED lights. If the CHARGE LED does not light, make sure the AC adaptor is plugged in securely.

INSTALLATION

NOTES:

- *Use only the supplied battery pack (TRB-8000 power source 600mAh, 3.6VDC)*
- *The battery pack is not charged properly if the charging contacts are dirty or tarnished. Clean the contacts occasionally with a dry cloth.*

After the battery pack is fully charged;

Operation	Approx. battery life
While in use (Talk mode)	up to 7 hours
While not in use (Standby mode)	up to 14 days

When "Low Battery" blinks on the LCD, all handset buttons are disabled and the battery needs to be charged. If this occurs during a call, you hear short beeps. Finish the call as soon as possible and place the handset on the base unit.



NOTES:

- *If a call comes in when the battery is too low to operate properly, you will be unable to answer the call or the call will be disconnected.*
- *The redial number is held in memory for up to 30 minutes while you replace the battery pack.*
- *If you must replace the battery pack during a telephone call, complete the replacement of the battery pack within 30 seconds, and you can return to the original call.*

INSTALLATION

Before using the Handset, make sure to read the following instructions

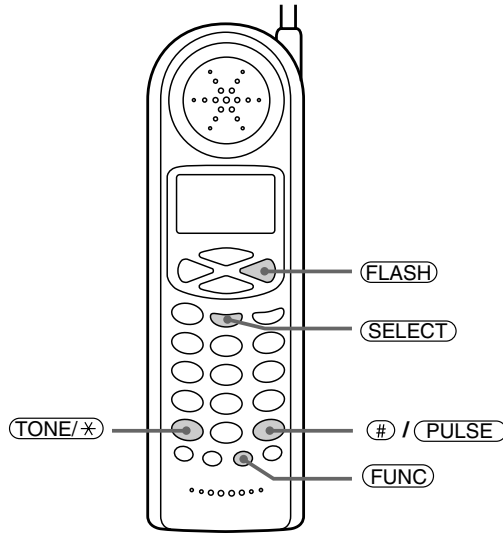

SETTING THE DIAL MODE

Depending on your dialing system, set the mode as follows:

1 Press and hold **FLASH** until you hear a confirmation tone.

2 To set the dial mode for pulse dialing, press **#** / **PULSE**. Or to set the dial mode for tone dialing press **TONE/***. A confirmation tone sounds to indicate the setting is complete.

Dial Mode:Pulse
Tone - Press *
Pulse - Press #

TONE/* ↓

Tone Dialing

Dial Mode:Tone
Tone - Press *
Pulse - Press #

/ **PULSE** ↓

Pulse Dialing

SETTING OR CANCELING THE AUTO TALK FUNCTION

If the handset is placed on the base unit, you can answer a call by lifting the handset from the base unit (Auto Talk). If the handset is not on the base unit, you can answer a call by pressing any one of the buttons (Any-key Answer function). When the Auto Talk function is set to ON, the Any-key Answer function is also set to ON.

When the Auto Talk function is set to OFF, you can lift the handset and view the caller ID information before taking the call. This function is preset to OFF.

1 Press **(FUNC)**. The LCD displays the current setting.

```
1▶Auto Talk:Off
2 CIDCW      :0n
3 Area Code:
```

2 Press **(SELECT)**. Each time you press **(SELECT)**, the On/Off setting will be switched.

3 Press **(FUNC)**. The handset returns to standby mode.

```
1▶Auto Talk:On
2 CIDCW      :0n
3 Area Code:
```

SETTING OR CANCELING CALLER ID ON CALL WAITING

This function is preset to ON so that you will receive caller ID on Call Waiting when you subscribe to both local telephone company services.

If you do not subscribe to these services, be sure to set this function to OFF.

1 Press **(FUNC)**. The LCD displays the current setting.

```
1▶Auto Talk:Off
2 CIDCW      :0n
3 Area Code:615
```

2 Press **(▼)** or **(2)** to move the pointer to CIDCW and press **(SELECT)**. Each time you press **(SELECT)**, the On/Off setting will be switched.

```
1 Auto Talk:Off
2▶CIDCW      :0n
3 Area Code:615
```

3 Press **(FUNC)** and replace the handset on the base unit.

INSTALLATION

SETTING THE AREA CODE

It is necessary to program your area code so that local calls will be displayed properly on caller ID.

1 Press **(FUNC)**.

```
1▶Auto Talk:Off
2 CIDCW      :0n
3 Area Code:
```

2 Press **(▼)** or **(3)** to move the pointer to Area Code.

```
1 Auto Talk:Off
2 CIDCW      :0n
3▶Area Code:
```

3 Press **(SELECT)**.

Enter a 3-digit area code. For example, enter "615."

```
1 Auto Talk:Off
2 CIDCW      :0n
3 Area Code:615
```

If you enter a wrong number, press **(DELETE)**.

4 Press **(SELECT)**.

Confirmation tone sounds.

```
1 Auto Talk:Off
2 CIDCW      :0n
3▶Area Code:615
```

5 Press **(FUNC)**.

The handset returns to the standby mode.

NOTES:

- **Change your area code when you move to another location that has a different area code.**
- **When you make a call or redial to a number within your area code, only the last 7 digits of the phone number are dialed when you set the area code.**

BASIC OPERATION

Before using the Handset, make sure to read the following instructions.

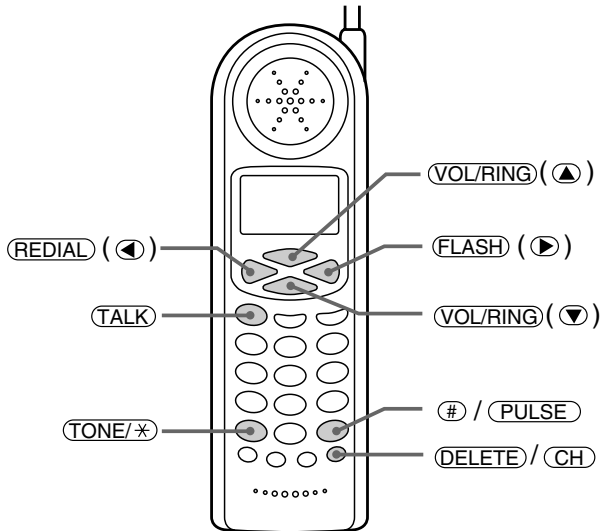

MAKING A CALL

Handset On The Base	Handset Off The Base
<ol style="list-style-type: none"> 1) Pick up the handset. 2) Press TALK. 3) Listen for the dial tone. 4) Dial the number. <p style="text-align: center;">OR</p> <ol style="list-style-type: none"> 1) Pick up the handset. 2) Dial the number, then press TALK. 	<ol style="list-style-type: none"> 1) Press TALK. 2) Listen for the dial tone. 3) Dial the number. <p style="text-align: center;">OR</p> <p>Dial the number, then press TALK.</p>
<p>To hang up: Press TALK, or return the handset to the base (Auto Standby).</p>	

RECEIVING A CALL

Handset On The Base	Handset Off The Base
<p>Pick up the handset (Auto Talk) or press TALK. To use Auto Talk function, see page 15.</p>	<p>Press any button (When the Auto Talk is set to on) or press TALK.</p>
<p>To hang up: Press TALK, or return the handset to the base (Auto Standby).</p>	

NOTE:

To delete a wrong number, press ◀ or ▶ and DELETE. To delete all numbers, press and hold DELETE.

BASIC OPERATION

REDIAL

Handset On The Base	Handset Off The Base
<ol style="list-style-type: none">1) Pick up the handset and press (TALK).2) Listen for the dial tone.3) Press (REDIAL).	Press (REDIAL) , then press (TALK) .

OUT OF RANGE

During a call, as you begin to move too far from the base unit, the noise increases. Then, you should move closer to the base unit. If you travel out-of-range, your call terminates. (See page 19 “Interference or static”)

CALL WAITING

To use this feature, you must subscribe to the Call Waiting Service.

1 When you hear a call-waiting tone during your conversation on the phone, simply press **(FLASH)**.

2 To return to the first caller, press **(FLASH)** again.

NOTE:

Pressing **(FLASH) without receiving a Call Waiting signal may disconnect the current caller.**

HANDSET EARPIECE VOLUME SETTING

To adjust the earpiece volume, press **(VOL/RING)** (**(▼)** or **(▲)**) during a call.

HANDSET RINGER VOLUME SETTING

To adjust the ringer volume, press **(VOL/RING)** (**(▼)** or **(▲)**) during standby mode.

NOTE:

When the handset is on the base, the handset ringer volume is disabled.

BASIC OPERATION

BASE SPEAKER VOLUME SETTING

To adjust the base unit speaker volume, press **(VOLUME+)** or **(VOLUME-)**.

TONE/PAUSE

To	Do this
To temporarily switch to tone dial (When the base is set to pulse mode), see page 14.	Press (TONE/*) . The following numbers will be sent as tone dialing.
To enter a pause within the dialing sequence	Press (PAUSE) . "P" appears in the display which represents a pause.

INTERFERENCE OR STATIC

If you hear noise during a call, press **(CH)** to select another channel. The LCD displays "Scanning" while changing a channel.

Talk 0:15
Scanning

PAGING THE HANDSET

- 1 To locate the handset while it is off the base, press **(PAGE)**. The handset beeps for 60 seconds.

Paging

To stop paging, press **(PAGE)** or any key at the handset, or return the handset to the base unit.

NOTE:

You cannot page the handset during a call.

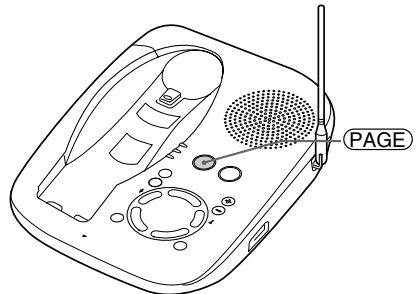

MEMORY DIALING

You can store up to 10 telephone numbers and their associated names in the memory.

NOTES:

- Always press a button within 20 seconds or the phone will return to standby.
- If you press a wrong button, an error tone sounds and the handset returns to standby mode.
- If you receive an incoming call or a pager call from the base unit during the operation, the operation will be cancelled.

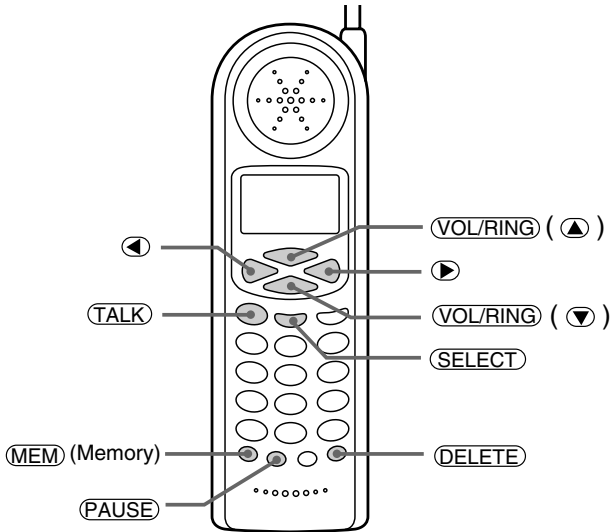

STORING NUMBERS

You can store up to 20 digits including #, *, and PAUSE as a telephone number, and up to 14 characters as a name in one memory address.

1 Pick up the handset and press and hold **MEM** till a beep sounds.

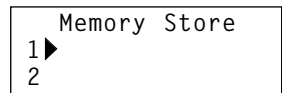

2 Enter a number (0-9), or press ▼, ▲ to select a free memory location number.

MEMORY DIALING

3 Press **(SELECT)**.

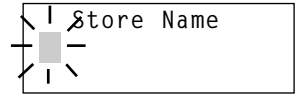

4 To enter a name, use the number keys.

- See the steps for storing names and special characters. (see page 22)
- If a name is not required, go to step 5.

5 Press **(SELECT)**.

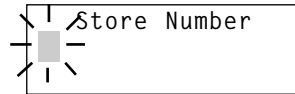

6 Enter a telephone number to be stored.

NOTES:

- **By pressing **(PAUSE)**, you can insert a 2-second pause in the memory dial to make a long distance call or call through a PBX.**
- **If you make a mistake, press **(▶)** and **(◀)** to move the cursor to the desired location.**
- **Press **(DELETE)** to delete characters as needed.**
- **Press and hold **(DELETE)** to delete all the characters.**

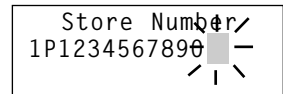

7 Press **(SELECT)**. A confirmation beep sounds and the number is stored.

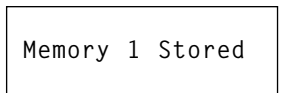

8 The LCD returns to Memory Store screen. To store more name and numbers, return to step 2. If you do not store name, only the memory location <Memory 1> appears.

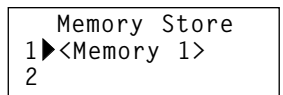

9 To finish the operation, press **(MEM)** or return the handset to the base unit.

MEMORY DIALING

STEPS FOR ENTERING NAMES AND SPECIAL CHARACTERS

Refer to the letters on the number buttons to select the desired letter. Each button selects a character as shown as below.

Keys	Number of times key is pressed								
	1	2	3	4	5	6	7	8	9
①	1								
ABC②	A	B	C	a	b	c	2		
DEF③	D	E	F	d	e	f	3		
GHI④	G	H	I	g	h	i	4		
JKL⑤	J	K	L	j	k	l	5		
MNO⑥	M	N	O	m	n	o	6		
PQRS⑦	P	Q	R	S	p	q	r	s	7
TUV⑧	T	U	V	t	u	v	8		
WXYZ⑨	W	X	Y	Z	w	x	y	z	9
OPER⑩	*	#	-	&	()	blank	0	

For example, to enter “Ted Doe” and 1-123-456-7890

- 1** Pick up the handset and press and hold **MEM**.
- 2** Enter a number or press **▼**, **▲** to select a free memory location number.
- 3** Press **SELECT**.
- 4** Press **8** once.
- 5** Press **3** five times then press **▶** to move the cursor to the right.
- 6** Press **3** four times then press **▶** twice to enter a space.
- 7** Press **3** once.
- 8** Press **6** six times.
- 9** Press **3** five times.

MEMORY DIALING

10 When finished, press **(SELECT)**.

11 Press **(1)** **(1)** **(2)** **(3)** **(4)** **(5)** **(6)** **(7)** **(8)** **(9)** **(0)** to be stored.

12 Press **(SELECT)**.

IF YOU MAKE A MISTAKE WHILE ENTERING A NAME

Use **(◀)** or **(▶)** to move the cursor to the incorrect character press **(DELETE)** to erase the wrong entry, then enter the correct character. To delete all characters, press and hold **(DELETE)**.

DIALING A STORED NUMBER

1 Pick up the handset and press **(MEM)**.

2 Press **(▼)**, **(▲)** or enter a number (0-9) to display the desired destination.

1▶	Ted Doe
2	DOE JOHN
3	MOM AND DAD

NOTE:

When you press **(SELECT)**, the LCD displays both of the name and the telephone number.

When the stored phone number has 15 or more digits, **→** is displayed next to the 13th digit. Press **(▶)** to see the rest of numbers, and **(◀)** to return.

1▶	1234567890123
2	
3	

3 Press **(TALK)**. The selected number will be dialed.

NOTE:

If you press **(MEM)** while you are selecting a location, memory selection is cancelled and the handset returns to standby.

MEMORY DIALING

EDITING AND DELETING STORED NUMBERS

You can delete a number or simply store another one in its place. When you store a new phone number, the data stored in that memory location is deleted automatically.

- 1** Pick up the handset and press and hold **(MEM)**. The confirmation tone sounds.

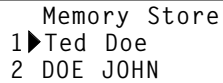

Memory Store
1▶ Ted Doe
2 DOE JOHN

- 2** Enter a number (0-9) or press **(▼)**, **(▲)** to select the memory location you want to edit/delete.

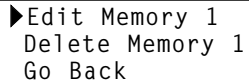

▶ Edit Memory 1
Delete Memory 1
Go Back

- 3** Press **(SELECT)**.

- 4** Press **(▼)** or **(▲)** to select the desired function and press **(SELECT)**. To edit the stored data, select “Edit.” To delete the data, select “Delete.” To return to the previous screen, select “Go Back.”

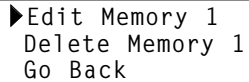

▶ Edit Memory 1
Delete Memory 1
Go Back

- 5** To edit data, go to step **a**. To delete data, go to step **b**.

a EDITING THE NAME AND TELEPHONE NUMBER

Use the number buttons and **(◀)** or **(▶)** buttons to change the name. (See “Storing Numbers” on page 20 for instructions on how to enter names).

- (1) Press **(DELETE)** to erase a character at the cursor position. The next character on the right moves to the cursor position.

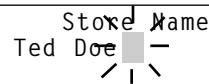

Store Name
Ted Doe █
/ | \

- (2) Press **(SELECT)**.

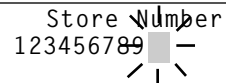

Store Number
123456789 █
/ | \

- (3) Press **(DELETE)** to erase numbers, and enter the correct number.

- (4) Press **(SELECT)**. A confirmation tone sounds and the number is stored. Press **(MEM)** or return the handset to the base unit.

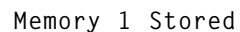

Memory 1 Stored

MEMORY DIALING

b DELETING THE STORED DATA

(1) Press ▲ or ▼ to move the pointer to select **Yes** or **No**.

```
Delete Memory 1?  
Yes  
▶No
```

(2) Press **SELECT** or **DELETE**.

If **Yes** is selected: A confirmation tone sounds and the number is erased.

```
Memory 1 Deleted
```

If **No** is selected: The LCD returns to the “Memory Store” display.

```
Memory Store  
1▶Ted Doe  
2 DOE JOHN
```

(3) Press **MEM**, or return the handset to the base unit.

CALLER ID/CALL WAITING

- Before you can take advantage of the Caller ID and Call Waiting features, you must subscribe to these services from your local telephone company.
- Name and number caller ID only work in conjunction with service provided by your local telephone company.

ANSWERING A CALL WITH CALLER ID SERVICE

- 1 When the caller ID message is received, the display shows the caller's phone number along with the date and time. The incoming call information is stored in Caller ID record. If the Caller ID service includes the caller's name, the caller's name appears on the display (up to 15 letters).

Number of calls from the same Caller ID _____	
The date and time received _____	5/11 12:30PM 01
Caller's name _____	SMITH JOHN
Caller's phone number _____	123-456-7890

You may receive any one of the following messages;

When invalid data is receivedIncomplete Data
When a private name is receivedPrivate Name
When a private number is receivedPrivate Number
When an unknown name is receivedUnknown Name
When an unknown number is receivedUnknown Number

- 2 When you pick up the phone, the display changes to "Talk".

Talk	0:00
Volume	Medium

NOTES

- If you answer a call before the Caller ID message is received (for example, before the second ring), the Caller ID message will not appear.
- When the call is received via a telephone company that does not offer Caller ID service, the caller's phone number and name do not appear (This includes international calls).
- When the call is via a Private Branch exchange (PBX), the caller's phone number and name may not appear.
- Data errors appear as " ■ ".

CALLER ID/CALL WAITING

"Caller ID" and "Call waiting" are separate services. CIDCW (Caller ID on Call Waiting) performs the same as regular Caller ID on a call waiting number. You must subscribe to the "Caller ID on call waiting (CID CW) services" before you can use the following features. The "Call waiting" service can also be used independently. Please contact your local telephone company for details.

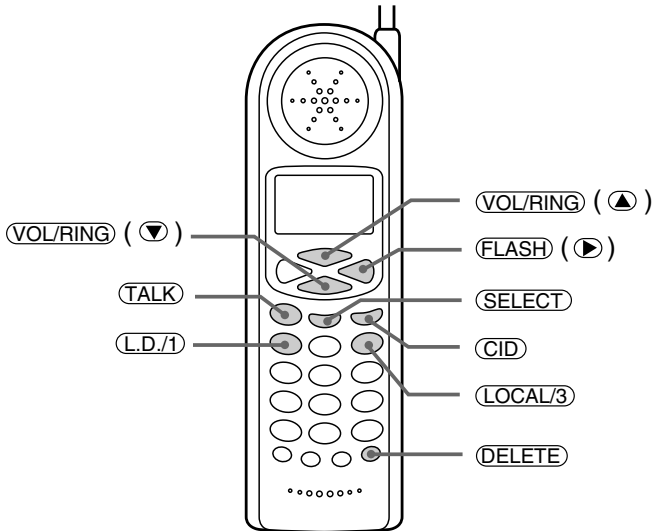

CALLER ID/CALL WAITING

SEARCHING CALLER ID MEMORY

To review who has called, follow the steps below.

The caller ID memory retains a listing of the 20 most recent callers.

- 1 Pick up the handset and press **(CID)**.

If new caller ID data does not exist:

Total:02

If there is new caller ID data:

New :01
Total:02

- 2 Press **(v)** to display the latest incoming call.

Press **(u)** to see previous incoming call.

1/7 9:30AM 12
DOE JOHN
555-2563

- 3 Press **(CID)** to return to standby mode.

CALLING BACK FROM THE CALLER ID LIST

- 1 Pick up the handset and press **(CID)**. Then, press **(v)** or **(u)** to display the number you wish to call.

1/7 9:30AM 12
SMITH JOHN
456-7890

- 2 Press **(TALK)**.
The displayed number will be dialed.

TALK
4567890

NOTE:

To enter a number for a long distance call, see "EDITING CALLER ID DATA" page 29. It is not necessary to add a "1" when dialing some area codes. If in doubt, check your local telephone directory.

CALLER ID/CALL WAITING

EDITING CALLER ID DATA

You can edit the Caller ID data.

- 1 Pick up the handset and press **(CID)**. Then, press **(▼)** or **(▲)** repeatedly to display the Caller ID data you want to edit.
- 2 Press **(L.D./1)** for a long distance call prefix “1” and **(LOCAL/3)** for area code setting and cancellation.

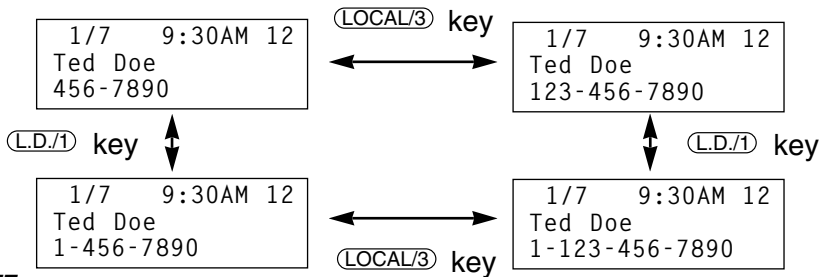

NOTE:

Before you use **(LOCAL/3)** for area code setting and cancellation, make sure the **AREA CODE** is set. (See page 16)

- 3 After editing Caller ID data, you can make the call or store procedures.

To make a call, press **(TALK)**.

To store into memory dial, press **(MEM)**. Then, select memory location with **(▼)** or **(▲)** and press **(SELECT)**.

TRANSFERRING CID NUMBER TO SPEED-DIAL MEMORY

- 1 Pick up the handset and press **(CID)**. Then, press **(▼)** or **(▲)** to indicate the number you want to store the memory.
- 2 Press **(MEM)**.
- 3 Enter a number (0-9) or press **(▼)**, **(▲)** to select memory location.

Select Location
1 ▶
2

CALLER ID/CALL WAITING

- 4 Press **(SELECT)**. A confirmation tone sounds and the Caller ID data is stored. Press **(CID)** to return to standby.

If you select a memory location which is already stored:

Press **(▲)** to select **Yes** and press **(SELECT)**.

Replace Memory? Yes ▶No

A confirmation tone sounds and the new data overwrites the old data. The LCD returns to the Caller ID display screen.

If you select **No** :

The LCD returns to the Caller ID display screen.
Press **(CID)** to return to standby mode.

DELETING CALLER ID DATA

DELETE INDIVIDUAL CALLER ID DATA:

- 1 Pick up the handset and press **(CID)**. Then, press **(▼)** or **(▲)** to display the caller ID number you want to delete from the memory.

- 2 Press **(DELETE)**.
Press **(▲)** or **(▼)** to select **Yes** or **No**.

Delete Message? ▶Yes No

- 3 Press **(SELECT)** or **(DELETE)**. If you select **Yes**, you hear a confirmation tone and the LCD displays the next caller ID data. If there is none, the LCD displays the number of calls.

If you select **No**, the LCD returns to the Call ID display screen.

- 4 Press **(CID)** to return to standby.

CALLER ID/CALL WAITING

DELETE ALL CALLER ID DATA:

1 Press **(CID)**.

```
New :01
Total:02
```

2 Press **(DELETE)**.
Press **(▲)** or **(▼)** to select Yes or No.

```
Delete All?
Yes
▶No
```

3 Press **(SELECT)** or **(DELETE)**.

If you select **Yes**, a confirmation tone sounds and the LCD displays "Total:00".

```
Total:00
```

If you select **No**, the LCD displays the number of Caller ID calls.

```
New :01
Total:02
```

4 Press **(CID)** to return to the standby mode.

CALL WAITING

The LCD will show another incoming call even if you are on the line. This feature can be enabled or disabled. If enabled, you hear the short beeps at regular intervals until the call is either answered, or the person calling hangs up. With Caller ID on call waiting, you can see who is calling to decide if you want to interrupt your current conversation to answer the incoming call.

WITH CALLER ID SERVICE

1 Before answering a call, check to see that the caller's name and telephone number are displayed on the screen. To switch to the waiting call, press **(FLASH)** on the handset. The first caller is put on hold.

2 To switch back to the first caller, press **(FLASH)** again.

NOTE:

Pressing (FLASH) without having received a Call Waiting signal may disconnect the current line.

USING THE MENU MODE

Menu mode allows you to set the following Answering System functions. Following MENU MODE instructions assume that every setting starts from standby mode.

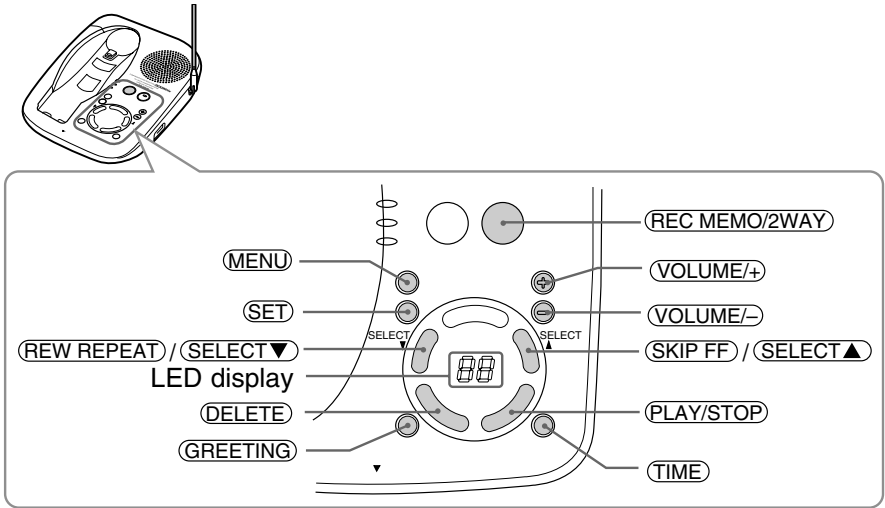

Menu No.	Function	
Menu1	Greeting message	--
Menu2	Clock	[0] - [59], [R], [P], [- -]
Menu3	Security code (PIN)	[00] - [99]
Menu4	Ringer volume	[H], [Lo], [OF]
Menu5	Ring time	[2], [4], [5], [t5]
Menu6	Recording time	[1], [4], [R]
Standby	Return to standby	[0] - [58], [FL], [R]

NOTES:

- If you make no entries within 20 seconds, or 20 seconds pass after a voice prompt/guidance or greeting, you will hear a long beep and the answering machine returns to standby. Note that time-out for clock setting is 2 minutes.
- Receiving a call or pressing talk will cancel the setting. If you press **(PLAY/STOP)**, the setting is canceled and returns to standby.
- You can scroll to the next menu option by pressing **(MENU)**.
- You can use **(VOLUME+)** or **(VOLUME-)** to adjust the announcement volume level during voice prompt/guidance.

USING THE MENU MODE

RECORDING THE GREETING MESSAGE

You can record a personalized greeting message (up to 30 seconds) or use the pre-recorded message. When a call is received, the answering machine answers the call and plays the greeting message.

- 1** Press **(MENU)** once.
You hear the pre-recorded message or current greeting message.
- 2** Press **(REC MEMO/2WAY)** and you will hear the guidance.
Start to record your greeting message.
For example:
“I can not come to the phone right now. Please leave a message after the tone”.
- 3** To finish recording your greeting message, press **(REC MEMO/2WAY)** or **(PLAY/STOP)**.
You hear a long beep and your greeting plays back.

NOTE:

*You can delete your greeting message by pressing **(DELETE)** after step 1.*

CHANGING THE GREETING MESSAGE

You can change between the pre-recorded greeting message and your own recorded greeting message.

- 1** Press **(GREETING)**.
The current greeting message will be played.
- 2** Press **(SELECT▲)** or **(SELECT▼)** to change to the other.
- 3** Press **(PLAY/STOP)** to exit the system.

USING THE MENU MODE

SETTING THE CLOCK

During play back, the answering machine announces the day and time that each message was recorded.

- 1** Press **(MENU)** twice.
The system announces the current time.
- 2** Press **(SET)**.
You hear the current day and the LED display shows the numbers [0] through [6].
- 3** Press **(SELECT▲)** or **(SELECT▼)** until the correct day is announced.
- 4** Press **(SET)**.
- 5** Press **(SELECT▲)** or **(SELECT▼)** until you hear the correct hour setting. The LED display shows the numbers [1] through [12] as each hour is announced.
- 6** Press **(SET)**.
- 7** Press **(SELECT▲)** or **(SELECT▼)** until you hear the correct minute setting. The LED display shows the numbers [00] through [59] as each minute is announced.
- 8** Press **(SET)**.
- 9** Press **(SELECT▲)** or **(SELECT▼)** until you hear AM or PM.
The LED display shows [A] or [P].
- 10** Press **(SET)**.
The answering machine announces the time that you have set.

NOTE:

- You can hear the time currently set by pressing **(TIME)**.
- If you do not complete the setting procedure within 2 minutes, the setting procedure is cancelled.

USING THE MENU MODE

SETTING THE SECURITY CODE (PIN)

To access your answering machine when you are away from home, you need to identify yourself with a security code or Personal Identification Number (PIN). You can select any two digit number between 00 and 99 as your security code (PIN).

- 1** Press **(MENU)** three times.
You hear the current setting, and the LED display shows the current security code (PIN).
- 2** Press **(SET)** to change the security code (PIN).
The system announces the current security code (PIN).
- 3** Press **(SELECT▲)** or **(SELECT▼)** until the desired number appears.
- 4** Press **(SET)** to set the security code (PIN).
The answering machine announces the new security code (PIN).

SETTING THE BASE RINGER VOLUME

Select one of three ringer volume settings (*H* : High, *L* : Low, *OFF* : off).

- 1** Press **(MENU)** four times.
You hear the current ringer volume, and the LED display shows the ringer volume.
- 2** Press **(SET)** .
- 3** Press **(SELECT▲)** or **(SELECT▼)** until the desired ringer volume appears (*H* : High, *L* : Low, *OFF* : off).
- 4** Press **(SET)** to set the ringer volume.
The system announces the ringer volume that you have set.

NOTE:

If the base ringer is set to off, and the handset is on the base, both the base and handset ringers are disabled.

USING MENU MODE

SETTING THE NUMBER OF RINGS

Select one of four ring time setting (2 : 2rings, 4 : 4rings, 6 :6rings, 65 : Toll Saver).

- 1** Press **(MENU)** five times.
The current ring time is displayed on the LED display.
- 2** Press **(SET)** to change the ring time.
- 3** Press **(SELECT▲)** or **(SELECT▼)** or until the desired ring time appears (2 : 2rings, 4 : 4rings, 6 :6rings, 65 : Toll Saver).
- 4** Press **(SET)** to set the new ring time.
The answering machine announces the ring time that you have set.

TS (TOLL SAVER MODE): The phone answers at the second ring when there are new messages, and the fourth ring when there are no new messages.

When you check the message from the outside phone, hang up if you hear the third ring to save the toll charge.

SETTING THE RECORDING TIME

Select one of two maximum recording times or Announce Only (1 : 1 minute, 4 : 4 minutes, A : Announce only).

- 1** Press **(MENU)** six times.
The LED display shows the current recording time.
- 2** Press **(SET)** to change the recording time.
- 3** Press **(SELECT▲)** or **(SELECT▼)** until the desired time appears (1 : 1 minute, 4 : 4 minutes, A : Announce only).
- 4** Press **(SET)** to set the new recording time.
The system announces the recording time that you have set.

A (Announce Only): If you set the recording time to A, the selected greeting message will be announced and no incoming message will be accepted. The LED display shows " A ".

USING THE ANSWERING MACHINE

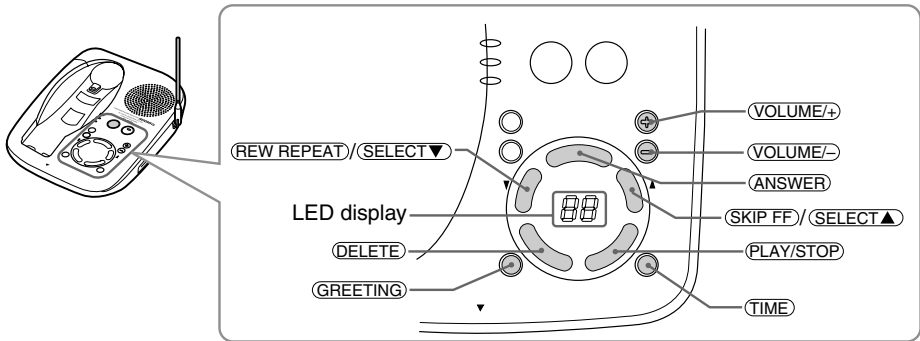

TURNING THE ANSWERING MACHINE ON & OFF

Press **(ANSWER)** to turn the answering machine on. The ANSWER LED will light, and the number of messages appears on the LED display. The greeting message will be played and you hear a long beep.

To turn the answering machine off, press **(ANSWER)**. The LED display turns off.

NOTE:

If the message storage area is full, the LED display shows "FL" and the system announces "No remaining time" after the greeting message. You should delete messages (see page 39). Otherwise, the system cannot record any new messages.

CHECKING AND SWITCHING GREETING MESSAGE

You can check the message and switch from the Pre-recorded message to the user greeting message.

- 1** Press **(GREETING)**.
The current greeting message will be played.
- 2** Press **(SELECT ▲)** or **(SELECT ▼)** to switch the greeting message, and the greeting message will be announced.
- 3** Press **(PLAY/STOP)** to exit the system.

USING THE ANSWERING MACHINE

CHECKING CLOCK SETTING

You can check the time (day, hour, minute, AM, and PM) by using the Time stamp.

To check the time, press **(TIME)**. The time will be announced.

PLAYING RECORDED MESSAGES

The display shows the total number of recorded messages. If new messages have been recorded, the number blinks.

To listen to the messages, press **(PLAY/STOP)**. Messages will be played in the order they were received. During playback, see the table below for more operation.

To playback the message	Press (PLAY/STOP) .
To repeat the previous message	Press (REW REPEAT) (within 2 seconds after the beginning of message).
To repeat the current message	Press (REW REPEAT) (after 2 seconds after the beginning of message).
To skip the message	Press (SKIP FF) .
To rewind the message in double speed	Press and hold (REW REPEAT) .
To playback the message in double speed	Press and hold (SKIP FF) .
To delete a message	Press (DELETE) during playback of the message you want to delete.
To stop playback	Press (PLAY/STOP) .
To delete all messages	Finish the playback of all messages. Then, press and hold (DELETE) till a beep sounds.
To adjust the speaker volume (0-9)	Press (VOLUME+) or (VOLUME-) repeatedly.

USING THE ANSWERING MACHINE

DELETING RECORDED MESSAGES

To delete all messages:

Press and hold **(DELETE)** till a beep sounds after playback of all messages.

If there are messages that you have not listened to, an error tone sounds and the messages will not be deleted.

To delete individual messages:

While playing back the message you want to delete, press **(DELETE)**. The message is deleted and the next message will be played.

NOTE: *To maintain maximum record time, it is a good idea to delete the old messages.*

SCREENING INCOMING CALLS

You can screen calls when the answering machine is on.

- 1** After the answering machine answers, the base speaker lets you hear the caller as the machine records the message.
- 2** To answer the call immediately, simply pick up the handset or press **(TALK)** if the handset is away from the base. The answering machine will disconnect automatically.

NOTES:

- *If the speaker volume is set to 0, you can not use the call screening feature.*
- *When the answering machine plays greeting message, the LCD displays [Answering].*

USING THE ANSWERING MACHINE

LEAVING A MEMO MESSAGE

You can use the base unit to record a memo (up to 10 minutes), as a reminder to yourself or as a message for someone else in the household. A memo is stored and played back like any other incoming message, and the LED display will blink to indicate that a message has been received.

- 1** Press and hold **REC MEMO/2WAY** till a beep sounds. You hear “Record your message after the tone” and a long beep.
- 2** Begin speaking close to the microphone.
- 3** When you finish recording, press **REC MEMO/2WAY** or **PLAY/STOP** .

RECORDING A PHONE CONVERSATION (2 WAY REC)

You can record a telephone conversation that is already in progress with the handset (up to 10 minutes). The conversation is stored and played back like an incoming message.

- 1** During a call with the handset, press and hold **REC MEMO/2WAY** till a beep sounds. Recording starts and both parties hear the intermittent beeps.
- 2** To stop recording, press **REC MEMO/2WAY** or **PLAY/STOP** . You hear a long beep.

NOTE: When recording a conversation, all number keys are disabled. Stop recording if you need to use any other handset keys.

USING THE ANSWERING MACHINE

CALLING IN FROM A REMOTE LOCATION

You can retrieve messages or change answering machine settings by calling your phone from a touch-tone phone. Even if the answering machine has been left off, you can still access it by turning it on first.

1 IF THE ANSWERING MACHINE IS OFF:

Let the phone ring at least 10 times. The line will connect and you will hear several short beeps. Press **#** and enter your security code (PIN).

IF THE ANSWERING MACHINE IS ON:

After playing your greeting message, press **#** and enter your security code (PIN).

2 The answering machine announces the number of new and old messages. The unit automatically starts playing the Help guidance.

3 Press **#** and the appropriate number button that corresponds to the operation you want (see TABLE OF COMMANDS on next page).

4 When you have finished, press **#** and **5** or hang up to exit the system.

NOTES:

- *When entering your security code (PIN), the second digit must be entered within 2 seconds after the first one.*
- *If you enter a wrong security code (PIN) 3 times, the line will be disconnected.*
- *Enter the command within 15 seconds while you hear intermittent beeps. Otherwise, the line is disconnected.*
- *When you call your phone while the message storage area is full, you will hear several short beeps after the 10th ring. Enter **#** and your security code (PIN), then you can continue to enter the commands.*
- *During operation from a remote location, [r], appears on the LED display.*

USING THE ANSWERING MACHINE

TABLE OF COMMANDS

OPERATION	Press	Remarks
To repeat an incoming message; (during playback)	# ①	Enter the command within 4 seconds after the beginning of the message to repeat the previous message, and after 4 seconds to repeat the current message.
To playback an incoming message (up to 4 minutes)	# ②	For longer playback, press # ② at the end of the message.
To skip to the next message (during playback)	# ③	
To delete individual messages (during playback)	# ④	
To stop operation	# ⑤	
To turn the answering system on	# ⑥	
To record a memo message (up to 4 minutes) To stop recording	# ⑦ # ⑤ or # ⑦	After you finish recording a memo message, press # ⑤ or # ⑦.
To record your greeting message To stop recording	# ⑧ # ⑤ or # ⑧	After you finish recording your greeting message, press # ⑤ or # ⑧.
To turn the answering system off	# ⑨	
To play Help Guidance	# ⑩	

For your handy reference guide, cut out the remote operation cards on page 49.

TROUBLESHOOTING

Should any problem occur with the unit, use the following simple tests to determine whether or not servicing is required.

PROBLEM	SOLUTION
The handset battery pack does not charge.	<ul style="list-style-type: none"> • The charging contacts of the handset and base are not clean. → Clean them with a dry cloth. • The battery is not connected with correct polarity. → Install the battery pack correctly. • The battery is several years old. → Replace with a new battery.
Battery pack becomes low quickly.	<ul style="list-style-type: none"> • The battery was not fully charged at the initial charging. → Charge the battery for 12 to 16 hours without any interruption. • The battery is several years old. → Replace with a new battery.
Can not make or receive calls Can not hear dial tone.	<ul style="list-style-type: none"> • The AC adaptor of the base unit is disconnected. → Plug the AC adaptor into the base unit and the AC 120V outlet. • The battery is low. → Place the handset on the base unit to recharge. • Telephone line cord is disconnected. → Check both ends of the telephone jack. • The previous call was not disconnected. → Press (TALK) to disconnect the line. • Trouble with the telephone line. → Check an extension line. • Outlet used is controlled by a wall switch in its OFF position. → Relocate it to another outlet. • The handset is too far from the base unit. → Bring the handset near the base unit. • Dial setting needs to be changed → Press and hold (FLASH) then choose the appropriate setting.
Low battery blinks on the display.	<ul style="list-style-type: none"> • The battery is low. → Return the handset to the base.
The handset does not ring or receive a page.	<ul style="list-style-type: none"> • The handset is located away from the base or the battery has been discharged. → Return the handset to charge when finished your call. • The digital security code is changed. → Remove the handset from the base unit and press and hold (PAGE) . While the handset is emitting, return the handset to the base unit. • The battery is low. → Place the handset on the base unit to recharge.

TROUBLESHOOTING

PROBLEM	SOLUTION
CHARGE LED will not light when the handset is placed on the base.	<ul style="list-style-type: none"> • The charging contacts of the handset and the base are not clean. → Clean them with a dry cloth.
	<ul style="list-style-type: none"> • The AC adaptor of the base unit is disconnected. → Plug the AC adaptor firmly into the base unit and AC 120V outlet.
	<ul style="list-style-type: none"> • The handset is not on the base. → Place the handset on the base properly.
Noise or interference.	<ul style="list-style-type: none"> • The handset is too far from the base unit. → Bring the handset near the base unit.
	<ul style="list-style-type: none"> • The battery is low. → Place the handset on the base unit to recharge.
	<ul style="list-style-type: none"> • The base unit is located in a place with high interference. → Relocate to another outlet.
	<ul style="list-style-type: none"> • Interference from TV, Microwave oven, computer and electrical appliances. → Press CH to select a clearer channel, or relocate the base unit.
	<ul style="list-style-type: none"> • Excessive line noise. → Check with another telephone.
	<ul style="list-style-type: none"> • The volume control is set too high. → Reduce volume to a lower setting.
	<ul style="list-style-type: none"> • The base antenna is not in a vertical position. → Lift the antenna to a vertical position.
The unit does not operate properly.	<ul style="list-style-type: none"> • The phone needs to be reset. → Disconnect the AC adaptor and reconnect it within few seconds.
When the handset is returned to the base unit with the volume level set at High, a momentary squeal or howling sound may sometimes be heard.	<ul style="list-style-type: none"> • This is normal. → It may be prevented by changing the volume setting to Medium or Low before returning the handset to the base unit.

TROUBLESHOOTING

PROBLEM	SOLUTION
The answering machine does not answer the call.	<ul style="list-style-type: none"> • The recording capacity is full. → Delete some or all of the recorded messages.
Answering machine does not play.	<ul style="list-style-type: none"> • No message is recorded. → This is normal.
The messages are not recorded/incomplete.	<ul style="list-style-type: none"> • The message was too long or too short. → The message should not be longer than the recording time (1 or 4 minutes), or shorter than 2 seconds.
	<ul style="list-style-type: none"> • The recording capacity became full. → Delete recorded messages.
	<ul style="list-style-type: none"> • The phone was answered during recording.
	<ul style="list-style-type: none"> • The recording time is set to A (announce only). → Set the REC TIME to 1 or 4 minute setting.
The answering machine does not respond to remote operation.	<ul style="list-style-type: none"> • You are not calling from a touch tone phone. → Call from a touch tone phone.
	<ul style="list-style-type: none"> • The security code (PIN) you entered was wrong. → Make sure you entered the correct security code (PIN). → If the answering machine is turned off, let the phone ring at least 10 times. The line will connect and you will hear several short beeps. Press # and enter your security code (PIN).
The LED display shows "A" (Announce only).	<ul style="list-style-type: none"> • This is normal. The recording time is set to A (announce only). → Set the REC TIME to 1 or 4 minute setting.
Can not delete messages.	<ul style="list-style-type: none"> • There is a message that has not been played. → Play the new message, then delete messages.
The phone does not display the Caller ID/Call Waiting data.	<ul style="list-style-type: none"> • You have to subscribe to Caller ID/Caller ID on Call Waiting services. → Check with your local telephone company.
	<ul style="list-style-type: none"> • You answered the call before Caller ID data was received. → Let the phone ring twice before you answer the call.
	<ul style="list-style-type: none"> • The call is via PBX. → See page 26.
	<ul style="list-style-type: none"> • The battery is not fully charged. → Charge the battery.
Auto talk and Any-key feature do not work.	<ul style="list-style-type: none"> • Auto talk feature has been set to OFF. → Set this feature to ON. (Any-key feature automatically set to ON)

WARRANTY/SERVICE

SERVICE REQUIREMENTS

If the cordless telephone should malfunction, or need changes or modifications, all repairs will be performed by an authorized Toshiba Service Station. This unit has been registered with the FCC for direct connection to the telephone network. Under the FCC program, no customer is authorized to repair this unit. This applies to units either in or out of warranty. If an unauthorized repair is performed, the registration of the unit for direct connection to the network will be null and void. If the unit is still in warranty, the remainder of the warranty period will also be null and void.

It is the responsibility of users requiring service to report the need for service to the Toshiba dealer.

IMPORTANT INSTRUCTIONS TO USERS

Your telephone equipment has been designed and constructed to conform to federal regulations and can be connected to the phone line as described in this manual.

Please note that each product connected to the telephone line places a certain load on the line. We designate this as the unit's "Ringer Equivalence Number."

It is most unlikely, but...If your telephone equipment should cause problems on the phone line, the phone company has the right to temporarily discontinue your service. If this happens, the phone company will notify you and give you the opportunity to correct the problem. Also, you need to know that the phone company does have the right to make changes in their lines and/or equipment.

If these changes might affect your telephone equipment (or require changes in the telephone equipment or its connection), the phone company will notify you in writing, so you have the chance to take whatever action necessary to ensure uninterrupted phone service.

FCC REQUIREMENTS

You are no longer required by the FCC to notify your local telephone company of your intent to connect a new telephone. Your local telephone company may call you and request information about your phone such as: the brand name, model number, registration number, and ringer equivalence number. This information is provided on a label located at the bottom of the base unit and handset.

You may not directly connect your telephone equipment to coin telephone services. Check with your local telephone company if you wish to connect your telephone equipment to a party line service. Some party line services require a special adaptor or modification to your telephone.

It should be noted that some cordless telephones operate at frequencies that may cause interference to nearby TVs and VCRs; to minimize or prevent such interference, the base of the cordless telephone should not be placed near or on top of a TV or VCR; and, if interference is experienced, moving the cordless telephone farther away from the TV or VCR will often reduce or eliminate the interference.

WARRANTY/SERVICE

TELEPHONE/TELEPHONE ANSWER MACHINE LIMITED WARRANTY

Toshiba America Consumer Products, Inc. ("TACP") and Toshiba Hawaii, Inc. ("THI") make the following limited warranties. These limited warranties extend to the original consumer purchaser or any person receiving this set as a gift from the original consumer purchaser and to no other purchaser or transferee.

Limited One(1) Year Warranty of Labor and parts

TACP/THI warrant this product and its parts against defects in materials or workmanship for a period of one(1) year after the date of original retail purchase. During this period, TACP/THI will repair or replace your defective product with a new or refurbished unit at our option.

Owner's Manual

You should read the owner's manual thoroughly before operating this product.

Your Responsibility

The above warranties are subject to the following conditions.

- (1) You must provide a copy of your bill of sale or other proof of purchase.
- (2) These warranties are effective only if the product is purchased and operated within the USA or Puerto Rico.

(3) Within the continental U.S.A., if you should find a defective product within the warranty period please call 1-877-644-7373.

(4) Warranties extend only to defects in materials or workmanship as limited above and do not extend to any product or parts which have been lost or discarded by you, or to damage to products or parts caused by misuse, accident, damage caused by Acts of God, such as lightning or fluctuations in electric power, improper installation, improper maintenance or use in violation of instructions furnished by us; or to units which have been altered or modified without authorization of TACP/THI, or to damage to products or parts thereof which have had the serial number removed, altered, defaced or rendered illegible.

(5) Physically damaged products are not acceptable for repair or exchange within or after the warranty period expires.

How to Obtain Warranty Service

In the event a problem should develop with your product, please proceed as follows;

In The Continental United States contact: **In Hawaii contact:**

www.toshiba.com/tacp

Toshiba Hawaii, Inc.
327 Kamakee Street,
Honolulu, HI 96814
(808)-591-8377

All warranties implied by state law, including the implied warranties of merchantability and fitness for a particular purpose, are expressly limited to the duration of the limited warranties set forth above. With the exception of any warranties implied by state law as hereby limited, the foregoing warranty is exclusive and in lieu of all other warranties, guarantees, agreements and similar obligations of manufacturer or seller with respect to the repair or replacement of any parts. In no event shall TACP/THI be liable for consequential or incidental damages.

No person, agent, distributor, dealer or company is authorized to change, modify or extend the terms of these warranties in any manner whatsoever. The time within which an action must be commenced to enforce any obligation of TACP/THI arising under the warranty or under any statute, or law of the United States or any state thereof, is hereby limited to ninety(90) days from the date you discover, or should have discovered, the defect. This limitation does not apply to implied warranties arising under state law.

This warranty gives you specific legal rights and you may also have other rights which may vary from state to state. Some states do not allow limitation on how long an implied warranty lasts, when an action may be brought, or the exclusion or limitation of incidental or consequential damages, so the above provisions may not apply to you.

REMOTE OPERATION CARDS

CUT

TOSHIBA

REMOTE OPERATION OF FT-8981

- A** Call your machine from touch tone phone. After your machine answers, enter # and security code (PIN) pressing each digit for at least 1 second. If you enter # and PIN correctly, your machine sounds invitation tone after the announcement. Now enter the command (# and number) by pressing the keypad.
- B** To playback incoming and memo messages, press #2. To skip, press #3 during playback. To repeat, press #1 during playback. To delete, press #4 during playback.
- C** To record memo message, press #7. To record greeting message, press #8. To stop recording, press #5. To turn on the answer mode, press #6. To turn off the answer mode, press #9.
- D** To stop operation, press #5.

TOSHIBA

OPERACIONES POR CONTROL REMOTO FT-8981

- A** Llame a su teléfono desde un teléfono de teclado. Después que su teléfono conteste, introduzca # y el código de seguridad (PIN) presionando cada dígito durante 1 segundo como mínimo. Si introduce correctamente # y el PIN, su teléfono emitirá un tono de invitación después del anuncio. Luego introduzca el mandato (# y un número) presionando las teclas.
- B** Para reproducir los mensajes recibidos y los memorandos presione #2. Para saltar presione #3 durante la reproducción. Para repetir presione #1 durante la reproducción. Para borrar presione #4 durante la reproducción.
- C** Para grabar mensajes de memorando presione #7. Para grabar un mensaje de saludo presione #8. Para detener la grabación presione #5. Para activar o desactivar el modo de contestación presione #6. Para desactivar el modo de contestación presione #9.
- D** Para detener la operación presione #5.

REMOTE OPERATION CARDS

CUT

WHILE PLAYING THE OGM, KEY-IN (#) AND PIN

MESSAGE REPEAT (#) 1	MESSAGE PLAYBACK (#) 2	MESSAGE SKIP (#) 3 (during playback)
MESSAGE DELETE (#) 4 (during playback)	RECORD STOP/ OPERATION STOP (#) 5	ANSWER ON (#) 6
MEMO RECORD (#) 7	GREETING RECORD (#) 8	ANSWER OFF (#) 9
	HELP GUIDANCE (#) 0	REMOTE ACCESS (#) PIN

DURANTE LA REPRODUCCIÓN DEL MENSAJE DE CONTESTACIÓN, PRESIONE (#) Y PIN

REPETICIÓN DE MENSAJE (#) 1	REPRODUCCIÓN DE MENSAJE (#) 2	SALTO DE MENSAJE (#) 3 (durante la reproducción)
BORRADO DE MENSAJE (#) 4 (durante la reproducción)	DETECCIÓN DE GRABACIÓN/OPERACIÓN (#) 5	ACTIVACIÓN DE CONTESTACIÓN (#) 6
GRABACIÓN DE MENSAJE DE MEMORANDO (#) 7	GRABACIÓN DE MENSAJE DE CONTESTACIÓN (#) 8	DESACTIVACIÓN DE CONTESTACIÓN (#) 9
	ASISTENCIA ANUNCIO (#) 0	ACCESO AL CONTROL REMOTO (#) PIN

**For technical assistance, purchase of accessories
or service, please access www.toshiba.com/tacp.**

IMPORTANT

We suggest you record the following information and retain for your records along with your bill of sale or equipment document.

Model no. _____ **Serial no.** _____
Purchase date _____ **Dealer** _____
Dealer address _____

© 2001 TOSHIBA AMERICA CONSUMER PRODUCTS, INC.