

TOPCOM[®]

BUTLER 4270/TWIN/ TRIPLE/QUATTRO



USER GUIDE
1.7



Important

To use 'Caller ID' (display caller), this service has to be activated on your phone line. Normally you need a separate subscription from your telephone company to activate this function. If you don't have the Caller ID function on your phone line, the incoming telephone numbers will NOT be shown on the display of your telephone.

This product is in compliance with the essential requirements and other relevant provisions of the R&TTE directive 1999/5/EC.
The Declaration of conformity can be found on :

<http://www.topcom.net/support/cedclarations.php>

To be connected to the public analogue telephone network.

The CE symbol indicates that the unit complies with the essential requirements of the R&TTE directive.

The features described in this manual are published with reservation to modifications.

1	Getting started	6
1.1	Installing the base	6
1.2	Installing the handset	6
1.3	If you have purchased a Twin/Triple/Quattro version	7
2	Getting to know your telephone	7
2.1	Keys/LED	7
2.2	Icons	8
2.3	Base lights	8
2.4	Navigating the menu	9
2.5	Menu overview	9
3	Using the telephone	10
3.1	Switching the handset ON/OFF	10
3.2	Changing the language	10
3.3	Making a call	10
3.4	Receiving a call	11
3.5	Handsfree mode	11
3.6	Adjust earpiece/handsfree volume	11
3.7	Redial a number from the list	11
3.8	Secrecy function (Mute function)	12
3.9	Locating a handset (paging function)	12
3.10	Keypad lock	12
3.11	Using the alphanumerical keypad	12
4	Phone book	13
4.1	VIP entries	14
5	Caller Identification	15
6	Calls list	16
6.1	Delete calls list	16
7	Personalise the handset	17
7.1	Setting the date and time	17
7.2	Using the alarm feature	17
7.3	Ringtone and volume	17
7.4	Handset name	18
7.5	Auto answer	18
7.6	Display contrast	19
7.7	Wall paper	19
7.8	Prefix	19
7.9	Outgoing Call barring	19
7.10	Key beep on/off	20
7.11	Message waiting settings (Phonemail service)	20
7.12	Default setting	21

8	Base settings	21
8.1	Ringtone	21
8.2	Handset priority	22
8.3	Line settings	22
8.4	System PIN	22
8.5	Default base settings	23
9	Additional handsets and bases	23
9.1	Adding a new handset	23
9.2	Removing a handset	23
9.3	Select a base	24
9.4	Using the intercom feature	24
9.5	Walkie Talkie function	25
10	Extra's	25
10.1	Calculator	25
10.2	Games	26
11	Troubleshooting	26
12	Technical data	27
13	Topcom warranty	27
13.1	Warranty period	27
13.2	Warranty handling	27
13.3	Warranty exclusions	27

Safety Instructions

- Only use the charger plug supplied. Do not use other chargers, as this may damage the battery cells.
- Only insert rechargeable batteries of the same type. Never use ordinary, non-rechargeable batteries. Insert rechargeable batteries so they connect to the right poles (indicated in the battery compartment of the handset).
- Do not touch the charger and plug contacts with sharp or metal objects.
- The operation of some medical devices may be affected.
- The handset may cause an unpleasant buzzing sound in hearing aids.
- Do not place the basic unit in a damp room or at a distance of less than 1.5 m away from a water source. Keep water away from the handset.
- Do not use the telephone in environments where there is a risk of explosions.
- Dispose of the batteries and maintain the telephone in an environment-friendly manner.
- As this telephone cannot be used in case of a power cut, you should use a mains-independent telephone for emergency calls, e.g. a mobile phone.

Disposal of the device (environment)

At the end of the product lifecycle, you should not throw this product into the normal household garbage but bring the product to a collection point for the recycling of electrical and electronic equipments. The symbol on the product, user guide and/or box indicate this.

Some of the product materials can be re-used if you bring them to a recycling point. By re-using some parts or raw materials from used products you make an important contribution to the protection of the environment.

Please contact your local authorities in case you need more information on the collection points in your area.



Cleaning

Clean the telephone with a slightly damp cloth or with an anti-static cloth. Never use cleaning agents or abrasive solvents.

1 Getting started

1.1 Installing the base

For installation, do the following:

- Plug one end of the adaptor into the outlet and the other end into the adapter jack on the bottom of the telephone.
- Connect one end of the telephone cord with the wall phone jack and the other end to the bottom of the telephone.

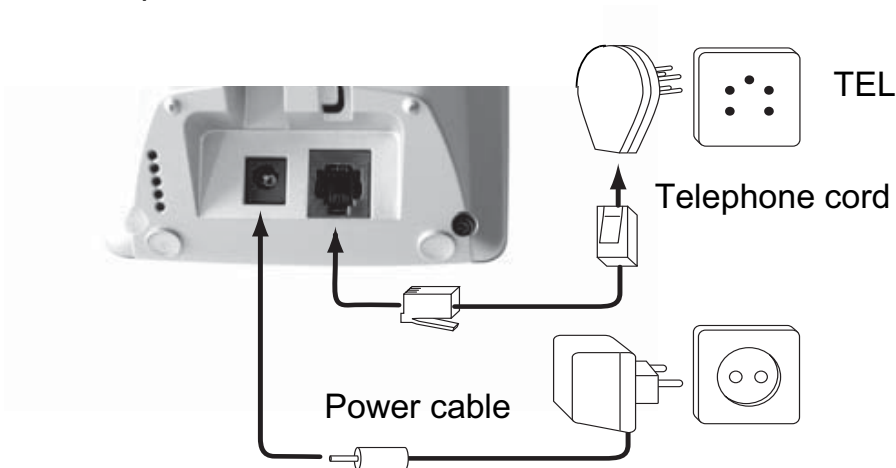

1.2 Installing the handset

- Open the battery compartment (see below).
- Insert the batteries **respecting the (+ and -) polarity**.
- Close the battery compartment.
- Leave the handset on the base unit for 20 hours. The charge indicator  (LED) on the base unit will light up.

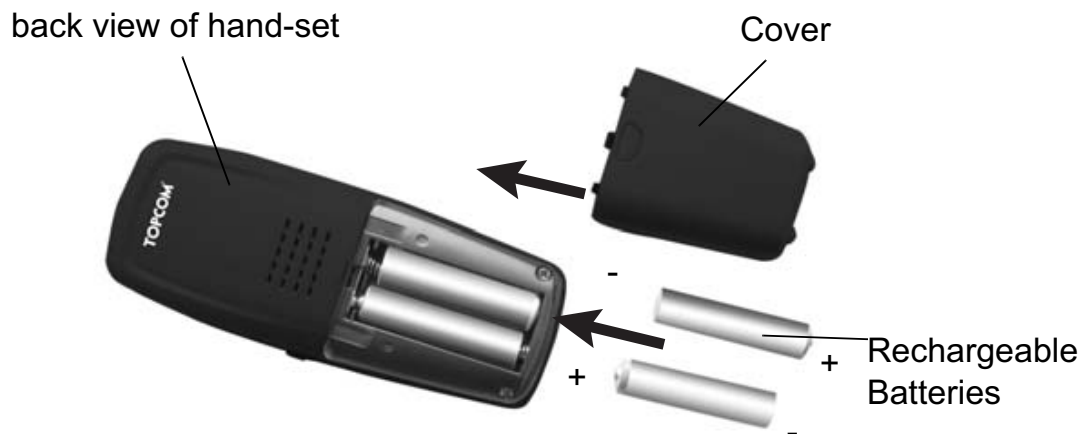

Before you use the telephone for the first time, you must first make sure the battery is charged for 20 hours. If you do not do this, the telephone will not work optimally.

1.3 If you have purchased a Twin/Triple/Quattro version

If you have purchased a Twin, Triple or Quattro version

- Plug one end of the adaptor into the outlet and the other end into the adapter jack on the bottom of the charger.
- Insert the batteries inside the handset.
- Charge the handset for at least 20 hours.

2 Getting to know your telephone

2.1 Keys/LED

Handset

1. Display
2. Soft Menu key 2
3. On-Hook/Power key
4. Pause/calculator key
5. Alphanumeric keys
6. INT key
7. Flash/Redial key
8. Down/Received call log key
9. Handsfree key
10. Off-hook key
11. Soft Menu key 1
12. Up/Missed calls key
13. Headset connection

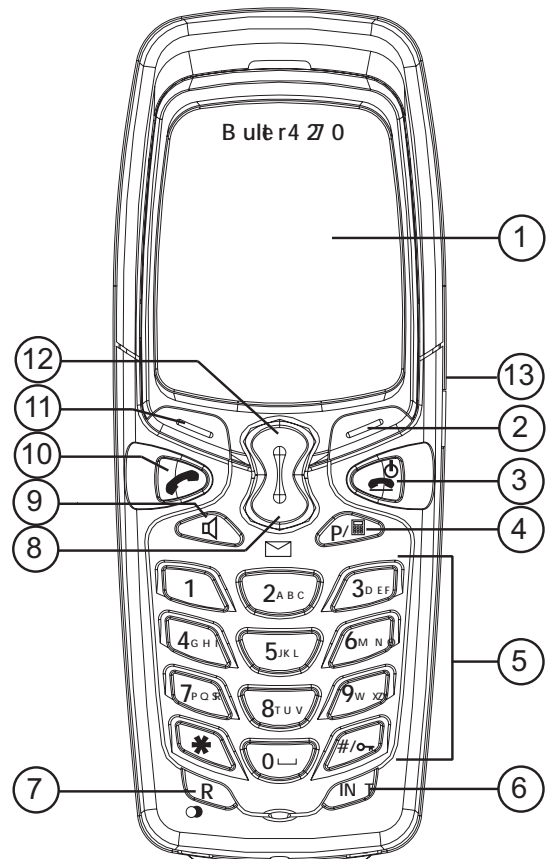





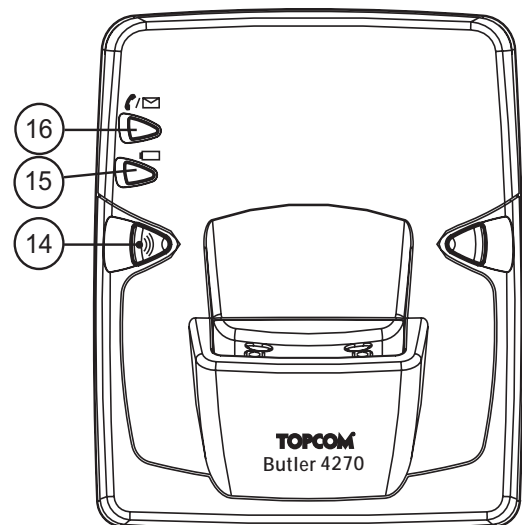







Base

14. Paging key
15. Handset on base LED
16. In use/Phonemail*(LED)



2.2 Icons

	Steady = In working range Blinking = Out working range
	When keypad is locked
	Line in use
	Alarm set icon
	External ring volume is On
	External ring volume Off
	Battery level indication
	Empty
	Low
	Medium
	Full
	No telephone line
	Microphone muted
	New voice mail message waiting*

* If the Phonemail service is available on the telephone line



2.3 Base lights

Blinking slow = Paging

 Blinking fast = base in registration mode
Steady = Charging

- OFF: Standby

- ON: Off hook

  - Blinking slowly: Incoming call
- Blinking rapidly: Phonemail*

* Only if the Phonemail service is available on the telephone line

2.4 Navigating the menu

The Butler 4270 has a menu system which is easy to use. Each menu leads to a list of options. The menu map is shown on the following paragraph.

When the handset is switched on and in standby, press the option button under “**MENU**” to open the main menu.





Press the Up/down  button to scroll to the menu option you want. Then press **OK** to select further options or to confirm the setting displayed. The scrollbar on the left of the screen shows the position in the menu.



Exit or go back one level in the menu

To the previous level in the menu, press **BACK**.

To cancel and return to standby at any time, press . If no button is pressed for 60 seconds, the handset returns to standby automatically.





2.5 Menu overview

	Menu	Submenu items
	Phonebook	Search Add Check
	Calls lists	Missed calls Received calls Dialed calls Delete
	Timer	Set Date/Time Alarm
	Handset Settings	Ring Type Ring Volume Ring On/Off PreFix Outgoing call Bar Message waiting Wall paper Language Contrast Key Tone Key Lock Auto Answer Handset name Default

	Menu	Submenu items
	Base settings	Base Ring tone Base ring On/Off Priority Call Alert Dial mode Register Handset De-register Select Base System PIN Flash Time Default
	Function	Calculator Games Walkie Talkie



3 Using the telephone

3.1 Switching the handset ON/OFF

- Press and hold  /  to switch the handset off.
- Press and hold  /  again or place it in the base to switch the handset back on.

3.2 Changing the language

Enter the "**Handset Setting**" menu in order to change the language:

- Select "**Menu**" with the left menu key .
- Press the up/down  key downwards 3 times.
- The "**Handset Settings**" Icon menu appears on the display. Select "**OK**".
- Use the up/down  key to scroll through the menu and select "**Language**". To confirm the language press "**OK**". The screen displays "**Set successfully**" if you have chosen English. Your handset's menus will be in English.
- To return to the previous menu, select "**Back**".

3.3 Making a call

3.3.1 Direct dialling



- Press  to obtain a line.
- Dial the number to be called.
- To hang up at the end of the call, press  or put the handset back on the base.



If the telephone line is not connected the  icon appears on the top of the screen.

3.3.2 Pre-dialling

With the pre-dialling feature you can enter and modify a number before making the call.

- Dial a number of up to 24 digits. Press and hold the Pause 'P'-key to insert a pause. The screen displays a "P".
- Select "**Clear**" with the right menu key  to correct. Press  to initiate the call. To hang up at the end of the call, press  or put the handset back on the base.

3.4 Receiving a call

When you receive an external call, the screen displays: "**Incoming Call**".

When it's a internal call the calling handset number will be shown.

If it's an external call and you have callerID or CLIP (see §"5 Caller Identification") the number who's calling will be shown. If the number match with a phonebook entry, the name from the phonebook will be shown.

To take the call:

- Press  (if the handset is not on its base/charger)

OR

- Lift the handset off its base (if the Auto Talk option is active) (see §"7.5 Auto Answer").
- The call in progress  icon appears on the screen. The call duration is displayed immediately.

3.4.1 Adjusting the ring volume during incoming call





You can adjust the ring volume with the Up/down key  while the telephone is ringing. The ring volume is displayed on the screen. There are 5 volume levels.

Press '**MUTE**' to turn off the ringer. The mute  icon will be shown. Press '**UNMUTE**' to turn the ringer back on.

3.5 Handsfree mode

Handsfree lets you talk to your caller without holding the handset. It also enables other people in the room listen to both sides of your conversation.

Make a handsfree call

- Press  the display shows '**Handsfree**'. Dial the number and your call can be heard over the handset's loudspeaker.
- To switch back to the handset at any time, press  again. Press  to end the call. You can switch any call to handsfree by pressing  during the call.



3.6 Adjust earpiece/handsfree volume

During a normal or handsfree call, press the Up/down key  to select volume 1-5.

3.7 Redial a number from the list

You can redial up to 20 of the last numbers called.

Redial a number from the list:

- Press  to enter the redial list. Scroll with the Up/down key  until the number you want is displayed.
- Press  to dial the number.



You can also consult the called list by the menu (See § “6 Calls list”) for more details.

3.8 Secrecy function (Mute function)

During conversation you can turn off the microphone so that the person on the other side of the line will not hear you:

- Select '**MUTE**' using the left menu key to deactivate the microphone.
- The mute  icon appears on the display
- Press the left menu key '**UNMUTE**' again to activate the microphone again

3.9 Locating a handset (paging function)

If you forgot where you left your handset you can press the paging key  on the base. All handset registered with the base will ring for about 30 seconds.

The  LED on the base will flash. To stop the ringer, press any key on the handset.

3.10 Keypad lock

You can lock the keypad to prevent accidental dialling while carrying the handset around.

- Press and hold the '#'-key until '**KEY LOCKED**' and  icon appears
- To unlock press and hold the '#'-key again until '**KEY UNLOCKED**' appears

3.11 Using the alphanumerical keypad

With your telephone you can also enter alphanumerical characters. This is useful for entering a name into the phonebook, giving a name to a hand-set, ...

To select a letter, press the corresponding key as many times as is necessary. For example to select an 'A', press '2' once, to select a 'B', press '2' twice and so on. To select 'A' and then B consecutively, select 'A', wait until the cursor moves on to the next character, then press '2' twice.

To select a space, press 0.

To change from small letters to capital or from capital to digits, press and hold the '*' key.

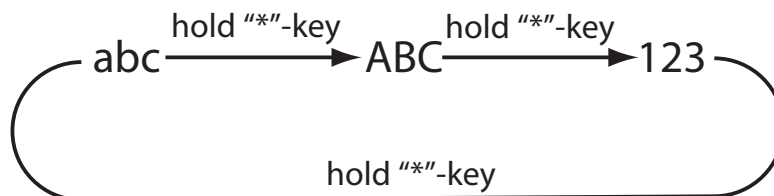

On the upper right side of the display you can see the different character table set:

The keypad characters are as follows:

Small letters (abc):

Key	First press	Second press	Third press	Fourth press	Fifth press
1	,	;	.		
2	a	b	c		
3	d	e	f		
4	g	h	i		
5	j	k	l		
6	m	n	o		
7	p	q	r	s	
8	t	u	v		
9	w	x	y	z	
0	Space				



Capital letters (ABC):

Key	First press	Second press	Third press	Fourth press	Fifth press	Sixth press	Seventh press	Eighth press
1	,	;	.	:	!	?	+	-
2	A	B	C					
3	D	E	F					
4	G	H	I					
5	J	K	L					
6	M	N	O					
7	P	Q	R	S				
8	T	U	V					
9	W	X	Y	Z				
0	Space							



4 Phone book

Each handset can store up to 50 names and numbers. Names can be up to 16 characters long and numbers up to 24 digits.



To add an entry

- Press left menu key  twice to enter the phonebook menu.
- Select 'ADD' with the Up/down key  and press 'OK'.
- Use the keypad to enter the name, then press 'OK'.
- Use the keypad to enter the number, then press 'OK'.
- Press and hold 'Back' to return to standby.



To Dial an entry

- Press left menu key  twice to enter the phonebook menu and select '**Search**'
- OR
- Press right menu key '**NAME**' in standby.
- Scroll  to the name you want or use the keypad to enter the first letter of the name.
- Press  to dial the number.



View details

- Press '**NAME**' then scroll  to the name you want or use the keypad to enter the first letter of the name. Press '**Details**'.
- Displays shows the name and number
- Press  to dial the number or press  to return to standby.

Edit name or number



- When viewing the details of an entry press '**OPTION**'.
- Scroll to '**Edit Name**' to edit the name or '**Edit No.**' to edit the number and press '**OK**'.
- Press '**CLEAR**' to delete or use the Up/down key  to position the cursor. Use the keypad to change the name or number. Press '**OK**'.
- The display returns to the list of names.
- Press  to return to standby.

Delete an entry

- When viewing the details of an entry press '**OPTION**'.
- Scroll  to '**Delete**' and press **OK**.
- Press **OK** to confirm or **BACK** to cancel.
- Press  to return to standby.

Check the phonebook memory

You can see how many entries are stored into the phonebook memory:

- Press left menu key  twice to enter the phonebook menu.
- Select '**Check**' with the Up/down key  and press '**OK**'

4.1 VIP entries

You can select which are VIP entries in the phonebook.

The VIP entries:

- are shown in RED color when scrolling through the phonebook list.
- have there own ring melody and volume.

When someone is calling you marked as a VIP entry in the phonebook you can hear this without looking at on the screen who's calling.

Changing into a VIP entry:

To make phonebook entries VIP entries:

- When viewing the details of an entry press '**OPTION**'.
- Scroll to '**SET VIP/NORMAL**' and press '**OK**'.
- Press '**OK**' to confirm or press '**Back**' to return to the option menu.

Changing a VIP entry back to normal:

To change a VIP entry back to normal:

- When viewing the details of an VIP entry press '**OPTION**'.
- Scroll to '**SET VIP/NORMAL**' and press '**OK**'.
- Press '**OK**' to make it normal again or press '**Back**' to return to the option menu.

5 Caller Identification





This service only works when you have a Caller ID/Clip subscription. Contact your telephone company!!

When you receive a call, the telephone number of the caller appears on the handset display. The telephone can receive calls in both FSK and DTMF. If the name is programmed in the Phone Book, the name in the Phone Book is displayed!

The telephone can store 20 calls in a Call List (both received and missed) that can be reviewed later. When the memory is full, the new calls automatically replace the oldest calls in the memory.

To read the missed received calls:

There are 2 ways to show the missed calls:

1. To consult the missed call list when display shows the missed calls amount during standby:
 - Press **DETAILS** and scroll to the list with the Up/down key .
2. To consult missed calls after activating other telephone functions:
 - Press **MENU** and scroll to the **Call log** menu with the Up/down key  and press **OK**.
 - Select **MISSED CALLS** menu and press **OK**

For further options see §“6 Calls list” below.



6 Calls list

Your Butler 4270 keeps a list of all your last calls. Each list can contains up to 20 records:

- **Missed Calls:** shows details of calls that were not answered.
- **Received Calls:** shows details of all recent callers.
- **Dialed Calls:** list shows details of the last 20 calls made from your handset.



A combined total of 60 calls can be stored in the Received and Missed calls.

Missed and received calls



- Press **Menu**
- Scroll  to **Call log** menu and press **OK**. Select **Received calls** or **Missed calls** and press **OK**.
- If the name of the caller has been stored in the phonebook it is displayed.
- Press  to dial a number or **Details** to see more details
- Press **Option** and select:
 - Save** : to store the number into the phonebook
 - Delete** : to delete the entry

Redial list:

Same as described at § “3.7 Redial a number from the list” you can also consult the called list from the menu.

- Press **Menu**
- Scroll  to **Call log** menu and press **OK**. Select **Dialed calls** and press **OK**.
- Press  to dial a number or **Details** then select:
- Press **Option** and select:
 - Save** : to store the number into the phonebook
 - Delete** : to delete the entry

6.1 Delete calls list

- Press **Menu**
- Scroll  to **Call log** and press **OK**. Select **Delete** and press **OK**.
- Press the Up/down key  to select the list you want to delete:
 - Missed Calls**
 - Received Calls**
 - Dialed Calls**
 - Delete All**
- Press **OK**

7 Personalise the handset



7.1 Setting the date and time

- Press **Menu**
- Scroll  to **Timer** menu and press **OK**. Select **Set Date/Time** and press **OK**.
- Enter the date (format: YYYY- MM-DD).
- Confirm with **OK**
- Enter the time (format: HH:MM).
- Confirm with **OK**

7.2 Using the alarm feature

Set the date and time and use your Butler 4270 to give you a reminder alarm. You can have a different alarm setting for each handset registered to your base. The alarm rings only at the handset, not at the base or any other handset.



7.2.1 Set the alarm

- Press **Menu**
- Scroll  to **Timer** menu and press **OK**. Select **Alarm** and press **OK**.
- Select **On/Off** with the Up/down  and press **OK**. Using the Up/down , choose one of the 3 types of setting: **Once**, **Everyday**, **Workday** (= from monday till friday) or **Off**. Confirm with **OK**. If you choose **Once**, **Everyday**, or **Workday** the display will show:



TIME (24 hr): 00:00

- Enter the time when you want the telephone to ring and confirm by pressing the **OK** key.
- To deactivate the Alarm function, select "**Off**" and confirm with "**OK**".

7.2.2 Setting the alarm tone

- Press **Menu**
- Scroll  to **Timer** menu and press **OK**. Select **Alarm** and press **OK**.
- Select **Ring Type** and press **OK**.
- Scroll with the Up/down  key to select the alarm tone (1-10) you want and press **OK**

7.2.3 Setting the alarm volume



- Press **Menu**
- Scroll  to **Timer** menu and press **OK**. Select **Alarm** and press **OK**.
- Select **Ring Volume** and press **OK**.
- Scroll with the Up/down  key to select the volume (1-5) you want and press **OK**

7.3 Ringtone and volume

7.3.1 Ringtone





You can choose 10 different ringer melodies for internal and external calls.

- From the standby screen, press **MENU** then scroll with the Up/down  key to **Handset settings** menu and press **OK**.
- Press **OK** to highlight **RingType**. Press **OK** to select **External Call**, **Internal**

- **Call or VIP call**, then press **OK**.
- Scroll  to the melody you want. During scrolling a sample is played. Press **OK**
- to select or **BACK** to return to the previous menu.
- Press  to return to standby.





7.3.2 Ringer volume

There are five handset ringer volume levels.

- Press **MENU** then scroll with the Up/down  key to **Handset settings** menu and press **OK**.
- Scroll  to **Ring Volume** and press **OK**.
- Select **External call**, **VIP call** or **Internal Call** and press **OK**
- The current setting is displayed. Press the Up/Down  key to decrease or increase the volume.
- Press **OK** to confirm.
- Press  to return to standby.



7.3.3 Ringer ON/OFF

You can turn the ring volume for Internal or external calls ON or OFF.

- Press **MENU** then scroll with the Up/down  key to **Handset settings** menu and press **OK**.
- Scroll  to **Ring On/Off** and press **OK**.
- Select **External On/Off** or **Internal On/Off** and press **OK**
- The current setting is highlighted. Select On or Off with the Up/Down  key and press **OK** to confirm.
- Press  to return to standby.



7.4 Handset name

You can change the handset name displayed on the handset during standby (max. 10 characters long). The name is shown in idle as long as the display backlit is active:





- Press **MENU** then scroll with the Up/down  key to **Handset settings** menu and press **OK**.
- Scroll  to **Handset Name** and press **OK**.
- Enter the handset name you want. Press **Clear** to make a correction and **OK** to confirm.
- Press  to return to standby.

7.5 Auto answer

When there is an incoming call and the handset is on the base, the phone automatically takes the line when lifted. This function can be turned on or off:





- Press **MENU** then scroll with the Up/down  key to **Handset settings** menu and press **OK**.
- Scroll  to **Auto Answer** and press **OK**.
- Select **Auto Answer On** or **Auto Answer Off** and press **OK** to confirm or **Back** to return.
- Press  to return to standby.

7.6 Display contrast

- Press **MENU** then scroll with the Up/down  key to **Handset settings** menu and press **OK**.
- Scroll  to **Contrast** and press **OK**.
- Select the right contrast with the Up/down  key and press **OK** to confirm or **Back** to return.
- Press  to return to standby.

7.7 Wall paper



The handset has 2 wall papers (background pictures) which you can choose from:

- Press **MENU** then scroll with the Up/down  key to **Handset settings** menu and press **OK**.
- Scroll  to **Wallpaper** and press **OK**.
- Select **Wallpaper 1** or **Wallpaper 2** with the Up/down  key and press **View** to show the selection. When the picture is shown you can still select another wallpaper with the Up/down  key. Press **OK** to confirm.
- Press  to return to standby.

7.8 Prefix

It's possible to program a prefix number into the handset. All numbers dialled out are dialled with this prefix number first.

7.8.1 Setting the prefix number

- Press **MENU** then scroll with the Up/down  key to **Handset settings** menu and press **OK**.
- Scroll  to **Prefix** and press **OK**.
- Select **Prefix Edit** with the Up/down  key and press **OK**.
- Enter the prefix number (max 5 digits) and press **OK**.

7.8.2 Setting the prefix On/off





When you are in the prefix menu:

- Select **Prefix On/Off** with the Up/down  key and press **OK**.
- Select **On** or **Off** and press **OK**.



7.9 Outgoing Call barring

You can bar certain outgoing calls depending with option you have select. When a call is barred, 'Call is barred' is shown on the display:



OFF:	all calls are allowed
External:	No external calls are allowed, only internal calls
PreCall:	Numbers starting with the programmed digits are barred
All:	All outgoing calls are barred, only incoming calls can be made

- Press **MENU** then scroll with the Up/down  key to **Handset settings** menu and press **OK**.
- Scroll  to **Outgoing CallBar** and press **OK**.
- Enter the Pin code ('0000')
- Select the desired barring type with the Up/down  key and press **OK**. When **Precall** is selected, the handset will ask to enter the 5 digit number and press **OK** to confirm.
- Press  to return to standby.

7.10 Key beep on/off



- Press **MENU** then scroll with the Up/down  key to **Handset settings** menu and press **OK**.
- Scroll  to **Key Tone** and press **OK**.
- Select **Key tone ON/OFF** **OK**.
- Press  to return to standby.

7.11 Message waiting settings (Phonemail service)



When you have phonemail* (or voicemail*) on your telephone line offered by the network operator and there is a new message waiting, the network can send a message waiting indication by the callerID information. The -icon appears on the top of the screen*. To hear your voice messages you have to dial the voice mail number. When all messages are heard, the network will send a message waiting off-signal and the -icon will disappear. If the network doesn't send this message waiting off-signal, you can manually remove the icon from the screen (see below).

You can also program the voice mail service number so that you just have to press and hold the '*' key in standby to dial the voice mail service number.

7.11.1 You can manually remove this -icon from the screen by:

- Press **MENU** then scroll with the Up/down  key to **Handset settings** menu and press **OK**.
- Scroll  to **Message waiting** and press **OK**.
- Select **Clear message** and press **OK**.
- Press  to return to standby.

7.11.2 Setting the voice mail service number

- Press **MENU** then scroll with the Up/down  key to **Handset settings** menu and press **OK**.
- Scroll  to **Message waiting** and press **OK**.
- Select **Service** and press **OK**.
- Enter the voice mail service number you have to dial to hear your voice mails
- Press  to return to standby.



* If the Phonemail service is available on the telephone line

7.12 Default setting

It is possible to return the handset settings to the original default configuration. This is the configuration which was installed when you first received the telephone.

The default parameters are:

External ring melody:	1
Internal ring melody:	3
VIP ring melody:	2
Ring volume all calls:	4
Received volume:	3
External & Internal Ringer ON/OFF:	On
Prefix on/off:	Off
Prefix number:	Empty
Call barring:	Off
Prefix Call barring number:	Empty
Phonemail service number:	Empty
LCD contrast:	Level 3
Keytone:	On
Key lock:	On



- Press **MENU** then scroll with the Up/down  key to **Handset settings** menu and press **OK**.
- Scroll  to **Default** and press **OK**.
- Press **OK** to confirm or **Back** to skip.
- Press  to return to standby.

8 Base settings



8.1 Ringtone

8.1.1 Ringtone

You can choose 5 different ringer melodies:

- Press **MENU** then scroll with the Up/down  key to **Base settings** menu and press **OK**.
- Press **OK** again to enter the **Base Ring Tone** menu.
- Scroll with the Up/down  key to the melody you want. During scrolling a sample is played. Press **OK** to select or **BACK** to return to the previous menu.
- Press  to return to standby.

8.1.2 Base ringer ON/OFF

- Press **MENU** then scroll with the Up/down  key to **Base settings** menu and press **OK**.
- Select **Base Ring On/Off** menu.
- Select **On** or **Off** and press **OK**
- Press  to return to standby.

8.2 Handset priority

Normally, if you have more than one handset registered to your base, they all ring at the same time. However, you can set one of them to ring before the others, so that calls can always be answered at one handset first.

- Press **MENU** then scroll with the Up/down  key to **Base settings** menu and press **OK**.
- Select **Priority Call Alert** menu and press **OK**.
- Select **All Handsets** to make all handsets ring together and press **OK**.



OR

Select which handset has to ring before the others and press **OK**. Select the number of rings at the handset before the other handsets start ringing and press **OK** to confirm.

- Press  to return to standby.



8.3 Line settings

8.3.1 Flash time

- Press **MENU** then scroll with the Up/down  key to **Base settings** menu and press **OK**.
- Select **Flash time** and press **OK**.
- Select 100, 250 or 600ms and press **OK**
- Press  to return to standby.



8.3.2 Dial mode

There are two types of dialling modes:

- DTMF/Tone dialling (the most common)
- Pulse dialling (for older systems)
- Press **MENU** then scroll with the Up/down  key to **Base settings** menu and press **OK**.
- Select **Dial mode** menu.
- Select **DTMF** or **Pulse** and press **OK**
- Press  to return to standby.

8.4 System PIN

The System PIN is used for registering and deregistering handsets and some other optional settings. The default System PIN is 0000.

- Press **MENU** then scroll with the Up/down  key to **Base settings** menu and press **OK**.
- Select **System PIN** menu.
- Enter the correct PIN code and press **OK**
- Enter the new PIN code and press **OK**
- Re-enter the new PIN code for confirmation and press **OK**
- Press  to return to standby.

8.5 Default base settings

It is possible to return the base settings to the original default configuration. This is the configuration which was installed when you first received the telephone.

The default parameters are:

Ring melody:	1
Ringer ON/OFF:	On
Ring priority:	All
Dial mode:	DTMF/Tone
System PIN:	0000

9 Additional handsets and bases



You can subscribe up to 6 handsets on a Butler 4270 base. Each handset can register to 4 base stations and the user can select which base he wants to use.

9.1 Adding a new handset



Only needed when you have deregistered a handset or when you bought a new one!!

First put the base into registration mode:

- Press and hold the paging  button on the base until you hear two beeps.
- The  LED will start to blink on the base for 60 seconds. During that time the base is ready to register a handset.

On the handset:

- Press **MENU** then scroll with the Up/down  key to **Base settings** menu and press **OK**.
- Select **Register handset** menu.
- Select the base you want (1-4). The bases which are already registered before are marked with *******
- Enter the system PIN (0000 by default) and confirm with **OK**.
- The handset will start to search the base.
- If the handset is registered successfully it will be shown and return to idle screen.
- If not, the PIN code will be asked again. Make sure you entered the correct PIN and that the base is in registration mode.

9.2 Removing a handset

- Press **MENU** then scroll with the Up/down  key to **Base settings** menu and press **OK**.
- Select **De-Register** menu.
- Enter the system PIN (0000 by default) and confirm with **OK**.
- Select the handset you want to remove from the current base and press **OK**

9.3 Select a base

You can switch your Butler 4270 handset between bases. You can also set it to automatically base select with the strongest signal. The handset must first be registered with each base individually.

- Press **MENU** then scroll with the Up/down  key to **Base settings** menu and press **OK**.
- Select **Select Base** menu. The current base being used is highlighted. The bases which are registered to this handset are marked with *******.
- Select the base you want or select **Auto Base** to connect to the base with the strongest signal. Press **OK**.



When you do Automatic base selection, the handset will only search in standby for the strongest base when it's out of range on the current base (not during communication)!

9.4 Using the intercom feature

9.4.1 Calling an internal handset

- Press **INT**. The screen displays "Intercom".
- Select the handset you want to call and press .

9.4.2 Transfer a external call to another handset

During an external call:

- Press **INT**.
- Enter the number of the handset you want to call. Your external correspondent is placed on hold. When the internal correspondent answers, press  to transfer the call. If the internal correspondent doesn't answer, press **INT** to retrieve the external correspondent or to go from one to the other.

9.4.3 Conference call



You can talk between 2 handset and a external line at the same time. During an external call:

- Press **INT**.
- Enter the number of the handset you want to call. Your external correspondent is placed on hold.
- When the internal correspondent answers, press '3'. If the internal correspondent doesn't answer, press **INT** to retrieve the external correspondent.

9.4.4 Taking an external call during an internal communication

When you are on intercom with another handset, you can still pick up outside calls.

To take an incoming call:



- Press . The internal communication is interrupted.
- Then press . You are in communication with the outside caller.

9.5 Walkie Talkie function

With the walkie talkie function you can communicate between 2 handsets without being registered or using the base.



To make walkie talkie calls you have to bring the handsets in the same group ID. All handset with the same group ID can call each other and can be called

9.5.1 Walkie talkie modus ON/OFF

- Press **MENU** then scroll with the Up/down  key to **Function** menu and press **OK**.
- Select **Walkie Talkie** menu.
- Select **Enable** to set the walkie talkie mode or **Disable** to leave it.
- When enabling it you have to enter the 4 digit group ID (for example '1234'). Enter the group ID and press **OK**.
- Enter the walkie talkie ID (1-9) and press **OK**.
- Press  to return to standby.

9.5.2 Making a walkie talkie call

When you have enabled the walkie talkie mode as above, the idle screen will show 'Walkietalkiemo'.

- Press  or INT followed by the walkie talkie ID number (1-9). The other handset will start to ring. On the ring handset you can see which handset is calling (WT ID marked in red).
- Press  on the ring handset and start speaking. To stop press .





10 Extra's

10.1 Calculator

You can enter the calculator by the menu or by pressing the calculator key .



- Press **MENU** then scroll with the Up/down  key to **Function** menu and press **OK**.
Select **Calculator** menu.

OR

- Press the calculator  key in idle mode.
- Enter the digits and press '#' for a radix point and '*'-key to switch between positive or negative. Press the Up-key  to select between adding(+), subtracting(-), division(/) and multiplication(*).
- Press the down-key  as a delete key.
- Press the left menu  key to see the result and  to leave the calculator.

10.2 Games

There are 2 games: Snake and Guess number:

- Press **MENU** then scroll with the Up/down  key to **Function** menu and press **OK**.
- Select **Games** menu.
- Select the game you want:
 - 1) Snake:**
 - * There are four options: Play, Set speed, Highest score and Help
 - * Use the Up/Down  key to select the Speed before starting the game
 - * Select **Help** to view the rules
 - 2) Guess Number:**
 - * There are four options: Start game, Level, Highest score and Help
 - * Select High, Medium or Low for the level
 - * Select **Help** to view the rules

11 Troubleshooting

Symptom	Possible cause	Solution
No display	Batteries uncharged	Check the position of the batteries
		Recharge the batteries
	Handset turned OFF	Turn ON the handset
No tone	Telephone cord badly connected	Check the telephone cord connection
	The line is occupied by another handset	Wait until the other handset hangs up
No antenna icon 	Handset out of range	Bring the handset closer to the base
	The base has no power supply	Check the mains connection to the base
	The handset is not registered on the base	Register the handset on the base
Base or handset do not ring	The ringing volume is zero or turned off	Adjust the ringing volume
Not possible to transfer a call on PABX	The FLASH time is too short	Set the unit to Long Flash time
Telephone does not react to pressing the keys	Manipulation error	Remove the batteries and put them back in place

12 Technical data

Standard:	DECT (Digital Enhanced Cordless Telecommunications) GAP (Generic Access Profile)
Frequency range:	1880 MHz to 1900 MHz
Number of channels:	120 duplex channels
Modulation:	GFSK
Speech coding:	32 kbit/s
Emission power:	10 mW (average power per channel)
Range:	300 m in open space /50 m maximum inhouse
Number of handsets:	Up to 6
Powersupply base:	230V / 50 Hz - 7,5V DC 320mA
Handset Batteries:	2 rechargeable batteries AAA, NiMh 600mAh 1,2V
Handset autonomy:	100 hours in standby
Talk time:	10 hours
Charging time:	6-8 hours
Normal conditions of use:	+5 °C to +45 °C
Flash time:	100,250 or 600ms

13 Topcom warranty

13.1 Warranty period

The Topcom units have a 24-month warranty period. The warranty period starts on the day the new unit is purchased. The warranty on batteries is limited to 6 months after purchase. Consumables or defects causing a negligible effect on operation or value of the equipment are not covered.

The warranty has to be proven by presentation of the original purchase receipt, on which the date of purchase and the unit-model are indicated.

13.2 Warranty handling

A faulty unit needs to be returned to a Topcom service centre including a valid purchase note.

If the unit develops a fault during the warranty period, Topcom or its officially appointed service centre will repair any defects caused by material or manufacturing faults free of charge.

Topcom will at its discretion fulfil its warranty obligations by either repairing or exchanging the faulty units or parts of the faulty units. In case of replacement, colour and model can be different from the original purchased unit.

The initial purchase date shall determine the start of the warranty period. The warranty period is not extended if the unit is exchanged or repaired by Topcom or its appointed service centres.

13.3 Warranty exclusions

Damage or defects caused by incorrect treatment or operation and damage resulting from use of non-original parts or accessories not recommended by Topcom are not covered by the warranty.

Topcom cordless phones are designed to work with rechargeable batteries only. The damage caused by the use of non-rechargeable batteries is not covered under warranty.

The warranty does not cover damage caused by outside factors, such as lightning, water and fire, nor any damage caused during transportation.

No warranty can be claimed if the serial number on the units has been changed, removed or rendered illegible. Any warranty claims will be invalid if the unit has been repaired, altered or modified by the buyer or by unqualified, non-officially appointed Topcom service centres.

TOPCOM[®]

visit our website
www.topcom.net

U8006412