

2-9773

# 25-Channel Cordless Telephone with Caller ID Use & Care Guide

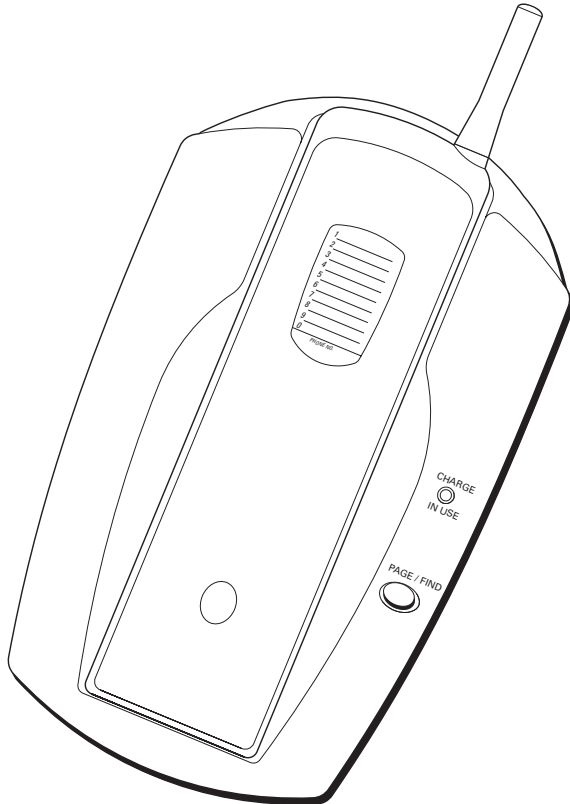

# Southwestern Bell

## FCC REGISTRATION INFORMATION

Your telephone equipment is registered with the Federal Communications Commission and is in compliance with parts 15 and 68, FCC Rules and Regulations.

### 1 Notification to the Local Telephone Company

On the bottom of this equipment is a label indicating, among other information, the FCC Registration number and Ringer Equivalence Number (REN) for the equipment. You must, upon request, provide this information to your telephone company.

The REN is useful in determining the number of devices you may connect to your telephone line and still have all of these devices ring when your telephone number is called. In most (but not all) areas, the sum of the RENs of all devices connected to one line should not exceed 5. To be certain of the number of devices you may connect to your line as determined by the REN, you should contact your local telephone company.

#### Notes

- This equipment may not be used on coin service provided by the telephone company.
- Party lines are subject to state tariffs, and therefore, you may not be able to use your own telephone equipment if you are on a party line. Check with your local telephone company.
- Notice must be given to the telephone company upon permanent disconnection of your telephone from your line.

### 2 Rights of the Telephone Company

Should your equipment cause trouble on your line which may harm the telephone network, the telephone company shall, where practicable, notify you that temporary discontinuance of service may be required. Where prior notice is not practicable and the circumstances warrant such action, the telephone company may temporarily discontinue service immediately. In case of such temporary discontinuance, the telephone company must: (1) promptly notify you of such temporary discontinuance; (2) afford you the opportunity to correct the situation; and (3) inform you of your right to bring a complaint to the Commission pursuant to procedures set forth in Subpart E of Part 68, FCC Rules and Regulations.

The telephone company may make changes in its communications facilities, equipment, operations or procedures where such action is required in the operation of its business and not inconsistent with FCC Rules and Regulations. If these changes are expected to affect the use or performance of your telephone equipment, the telephone company must give you adequate notice, in writing, to allow you to maintain uninterrupted service.

## INTERFERENCE INFORMATION

This device complies with Part 15 of the FCC Rules. Operation is subject to the following two conditions: (1) This device may not cause harmful interference; and (2) This device must accept any interference received, including interference that may cause undesired operation.

This equipment has been tested and found to comply with the limits for a Class B digital device, pursuant to Part 15 of the FCC Rules. These limits are designed to provide reasonable protection against harmful interference in a residential installation.

This equipment generates, uses, and can radiate radio frequency energy and, if not installed and used in accordance with the instructions, may cause harmful interference to radio communications. However, there is no guarantee that interference will not occur in a particular installation.

If this equipment does cause harmful interference to radio or television reception, which can be determined by turning the equipment off and on, the user is encouraged to try to correct the interference by one or more of the following measures:

- Reorient or relocate the receiving antenna (that is, the antenna for radio or television that is "receiving" the interference).
- Reorient or relocate and increase the separation between the telecommunications equipment and receiving antenna.
- Connect the telecommunications equipment into an outlet on a circuit different from that to which the receiving antenna is connected.
- Consult the dealer or an experienced radio/TV technician for help.

If these measures do not eliminate the interference, please consult your dealer or an experienced radio/television technician for additional suggestions. Also, the Federal Communications Commission has prepared a helpful booklet, "How To Identify and Resolve Radio/TV Interference Problems." This booklet is available from the U.S. Government Printing Office, Washington, D.C. 20402. Please specify stock number 004-000-00345-4 when ordering copies.

## HEARING AID COMPATIBILITY

This telephone system meets FCC standards for Hearing Aid Compatibility.

# TABLE OF CONTENTS

FCC REGISTRATION INFORMATION .....	2
HEARING AID COMPATIBILITY .....	2
INTERFERENCE INFORMATION .....	2
<b>INTRODUCTION .....</b>	<b>4</b>
CALLER ID .....	4
CALL WAITING .....	4
CALLER ID WITH CALL WAITING .....	4
VOICE MESSAGING .....	4
HANDSET SOUND SIGNALS .....	5
<b>INSTALLATION AND SETUP .....</b>	<b>6</b>
MODULAR JACK REQUIREMENTS .....	6
DESKTOP INSTALLATION .....	7
WALL MOUNT INSTALLATION .....	8
<b>INSTALLING THE BATTERY .....</b>	<b>9</b>
TO REPLACE THE BATTERY .....	9
<b>TELEPHONE SETUP .....</b>	<b>10</b>
SETTING AREA CODE FOR CALLER ID ..	10
<b>TELEPHONE OPERATION .....</b>	<b>11</b>
RECEIVING A CALL .....	11
MAKING A CALL .....	11
PHONE LIGHT .....	11
REDIAL .....	11
FLASH BUTTON .....	11
CHANNEL BUTTON .....	11
TEMPORARY TONE .....	12
PAGING THE HANDSET .....	12
RINGER SWITCH .....	12
VOLUME SWITCH .....	12
<b>CALLER ID OPERATION .....</b>	<b>13</b>
RECEIVING AND STORING CALLS .....	13
REVIEWING MESSAGES .....	14
MESSAGE ERRORS .....	14
DIALING A CALLER ID NUMBER .....	15
DELETING CALLER ID RECORDS .....	15
<b>SPECIAL FEATURES .....</b>	<b>16</b>
CALL WAITING WITH CALLER ID .....	16

STORING NAMES AND NUMBERS .....	16
INSERTING A PAUSE IN THE DIALING	
SEQUENCE .....	17
CHANGING A STORED NUMBER .....	18
DIALING A STORED NUMBER .....	18
CHAIN DIALING FROM MEMORY .....	18
REVIEWING AND DELETING STORED	
NUMBERS .....	19
VERY IMPORTANT PERSON (VIP) FEATURE	
19	
STORING A VIP NUMBER IN MEMORY	19
CALLING A VIP NUMBER .....	19
REMOVING A VIP NUMBER .....	20
ERASING ALL VIP NUMBERS .....	20
VOICE MESSAGING .....	21
<b>BATTERY SAFETY PRECAUTIONS .....</b>	<b>22</b>
<b>GENERAL PRODUCT CARE .....</b>	<b>22</b>
<b>MESSAGE INDICATORS .....</b>	<b>23</b>
<b>TROUBLESHOOTING TIPS .....</b>	<b>24</b>
CALLER ID .....	24
CALL WAITING .....	24
TELEPHONE .....	24
BATTERY .....	26
CALLER ID/CALL WAITING/VOICE	
MESSAGING .....	27
<b>CAUSES OF POOR RECEPTION .....</b>	<b>27</b>
<b>SERVICE .....</b>	<b>27</b>
<b>ACCESSORY ORDER FORM .....</b>	<b>28</b>
<b>INDEX .....</b>	<b>29</b>
<b>LIMITED WARRANTY .....</b>	<b>31</b>

**WARNING: TO PREVENT FIRE OR ELECTRICAL SHOCK HAZARD, DO NOT EXPOSE THIS PRODUCT TO RAIN OR MOISTURE.**

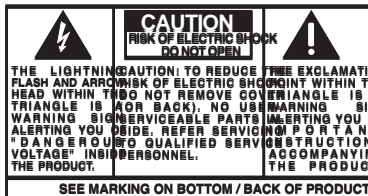

# **INTRODUCTION**

---

Your Southwestern Bell 2-9773 cordless phone is designed to give you flexibility in use and high quality performance. You can use this phone with basic telephone service, but it fully functions when equipped with the following features:

## **CALLER ID**

This feature allows you to see the number or name and number of the person calling before you answer the phone.

## **CALL WAITING**

This feature allows you to answer incoming calls while you are talking on the phone.

## **CALLER ID WITH CALL WAITING**

Also known as Type II Caller ID, this feature allows you to see the name and number of a call that beep in while you are talking on the phone with someone else.

**VERY IMPORTANT:** The Caller ID with Call Waiting feature of this phone is totally dependent upon your phone company's capabilities. You may subscribe to one service or the other, or even to both, and this phone will function properly.

But to take advantage of the Caller ID with Call Waiting feature, you must call your local phone company and tell the representative that you have a Caller ID/Call Waiting device that integrates the two services, regardless of whether or not you already subscribe to one or both services independently.

The phone companies that do have the ability to integrate Call Waiting and Caller ID must program your telephone line for the feature to work.

## **VOICE MESSAGING**

This features, which requires a subscription from the telephone company, allows callers to leave messages while you are talking on the phone.

**VERY IMPORTANT:** To fully take advantage of this phone's features, you must subscribe to Caller ID, Call Waiting and Voice Message services from your telephone company.

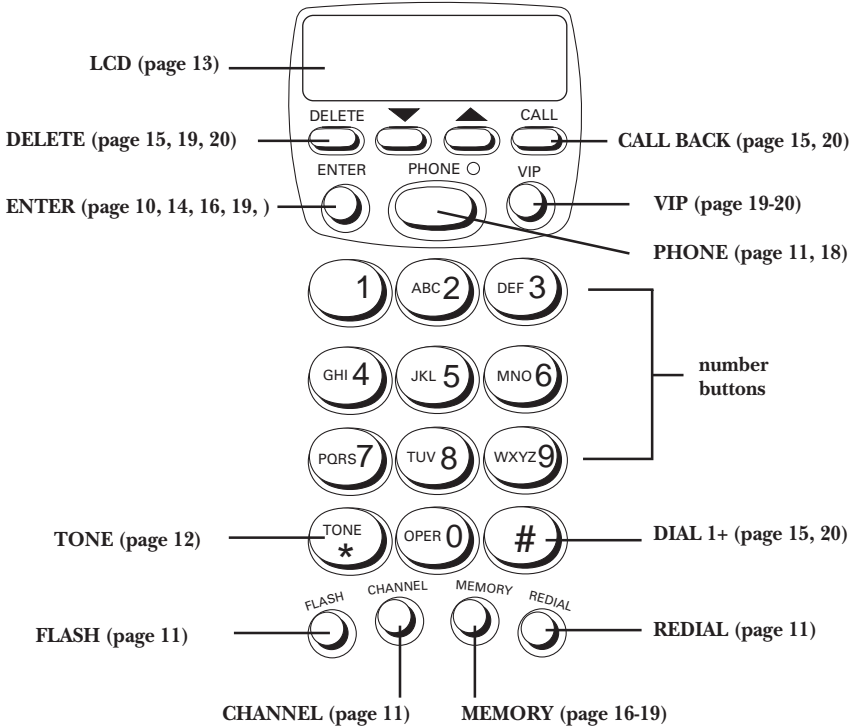

## HANDSET SOUND SIGNALS

Signal	Meaning
Three long beeps	Page signal
A long warbling tone (with ringer on)	Signals an incoming call
Four short beeps	Out of range warning

# INSTALLATION AND SETUP

---

Make sure your package includes the items shown here.

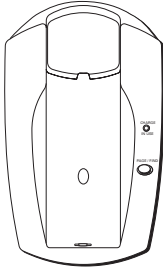

Base



Handset

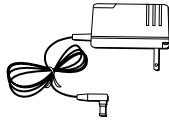

AC power supply



wall mount bracket



Short telephone line cord



Telephone line cord

**NOTE:** Use only the Thomson 5-2385 power supply that came with this unit. Using other adapters may damage the unit.

## MODULAR JACK REQUIREMENTS

You need an RJ11 type modular jack, which is the most common type of phone jack and might look like the one pictured here. If you don't have a modular jack, call your local phone company to find out how to get one installed.

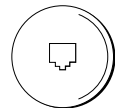

**INSTALLATION NOTE:** Some cordless telephones operate at frequencies that may cause interference to nearby TVs and VCRs. To minimize or prevent such interference, the base of the cordless telephone should not be placed near or on top of a TV or VCR. If such interference continues, move the cordless telephone farther away from the TV or VCR.

# DESKTOP INSTALLATION

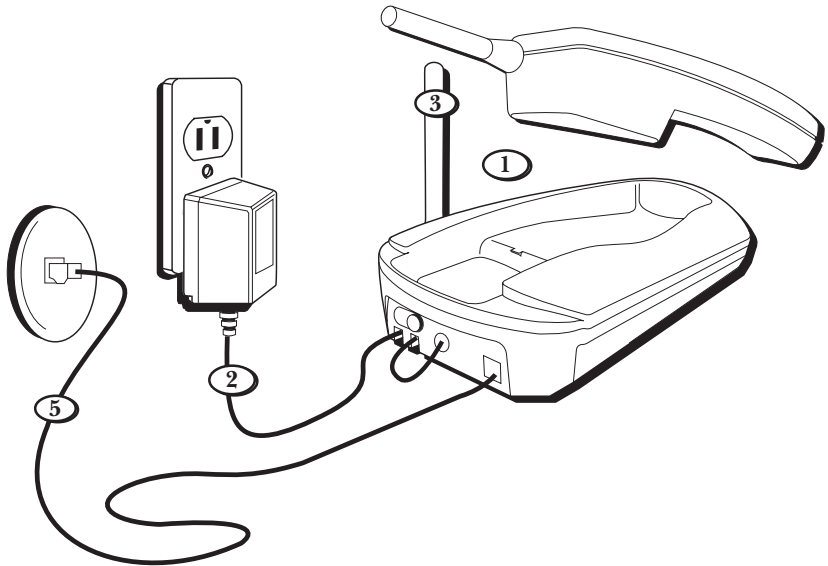

1. Cradle the phone.
2. Plug the power supply cord into the base and then into an AC outlet.
3. Raise the base antenna.
4. **Allow phone to charge for 12 hours before using the first time.**

The **CHARGE/IN USE** light comes on indicating that the battery is charging.

5. After charging, connect the telephone cord to the phone and then to the wall jack.

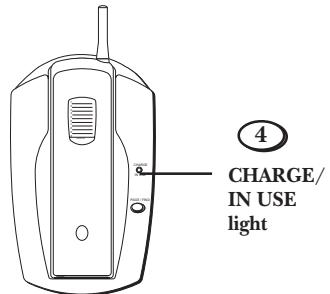

## WALL MOUNT INSTALLATION

Because it is necessary to cradle the handset for 12 hours prior to connecting it for use the first time, it is better to leave the unit on a flat surface during initial charge before attempting to hang it on the wall.

1. Cradle the handset.
2. Connect the power supply adapter into the base and then an AC outlet.
3. **Allow phone to charge for 12 hours before using the first time.**

The **CHARGE/IN USE** light comes on indicating that the battery is charging.

4. After charging, plug the short phone line cord into the phone jack on the back of the unit and then to the wall jack.
5. Attach the wall mount by inserting the two tabs at the top and then snapping the tab at the bottom into place.

6. Slip the mounting holes over the wall plate posts and slide the unit down firmly into place. (Wall plate not included.)

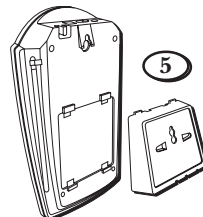
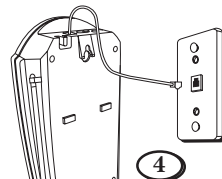
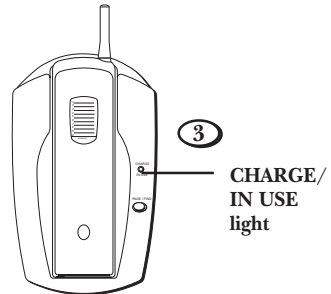
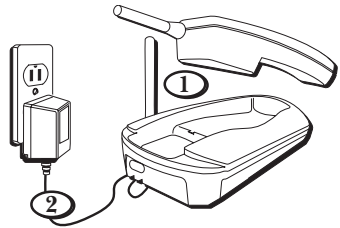



# INSTALLING THE BATTERY

---

The handset comes with a brand new, consumer-replaceable nickel cadmium (NiCad) battery pack. With normal use and recharging, a NiCad battery pack should last a full year. Use only BT-12 replacement battery.

## TO REPLACE THE BATTERY:

1. Make sure phone is **OFF** before you replace battery.

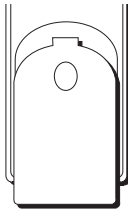

2. Slide open the battery compartment door.

Battery Holding Strap

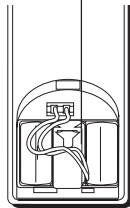

3. Unhook the strap holding the battery in place.

Plug

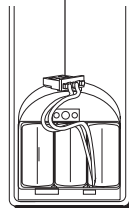

4. Pull out the battery plug.

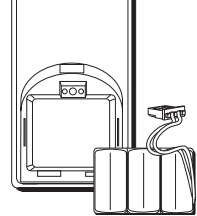

5. Remove the battery pack.

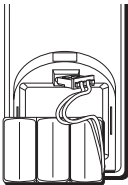

6. Replace and plug in the new battery pack.

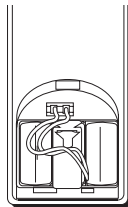

7. Reconnect the strap to secure the battery.

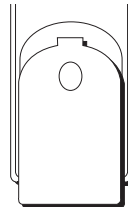

8. Replace the battery compartment door.

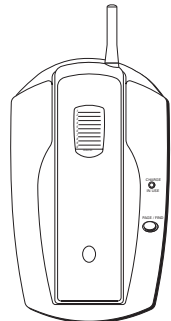

9. Charge the battery for 12 hours before use.

# TELEPHONE SETUP

## After charging the handset for an initial 12 hours:

1. Set the **PULSE/TONE** switch to TONE for touch-tone service or PULSE for rotary service. If you don't know which type of service you have, check with the phone company.
2. Plug the telephone line cord into the base and into a modular jack.
3. Turn on the **RINGER** switch so the handset rings for incoming calls.

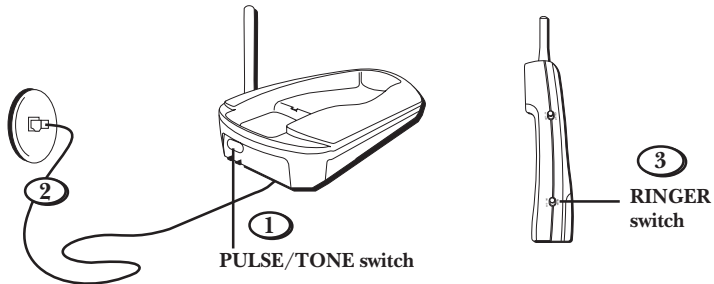

## SETTING THE AREA CODE FOR CALLER ID

Setting your area code is necessary for proper caller ID operation.

Once you set the code, the phone will automatically remove it from local calls within your area before it stores the number in memory. This will enable you to use the Redial feature more efficiently because you will not have to remove the code each time you call that number.

To set your area code:

1. Make sure the phone is **OFF**.
2. Press **ENTER**. The Caller ID display on the handset prompts you to enter your area code.
3. Enter your 3-digit area code by pressing the appropriate number keys. The phone emits 2 beeps to confirm it has accepted the area code entry.
4. To change or enter your area code again, follow steps 1-3 above.

# TELEPHONE OPERATION

---

## RECEIVING A CALL

1. Check the display to see who is calling.
2. Press the **PHONE** button to answer the call.



## MAKING A CALL

To make a call, press the **PHONE** button before you dial. To hang up, press **PHONE** again or put the handset back on the base.



## PHONE LIGHT

You know the phone is on when you see the **PHONE** light on the handset come on.



## REDIAL

Press the **REDIAL** button to redial the last number you dialed.



## FLASH BUTTON

Use the **FLASH** button to activate custom calling services, such as call waiting or call transfer. These services are available through your local phone company. The **FLASH** button is also used to enter a pause in the dialing sequence.



**TIP:** Do not use the **PHONE** button to activate custom calling services, such as call waiting, or you will hang up the phone.

## CHANNEL BUTTON

While talking, you might need to manually change the channel in order to get rid of static. Press and release the **CHANNEL** button to advance to the next clear channel.



## TEMPORARY TONE

This feature enables Pulse (rotary) service phone users to access touch-tone services offered by banks, credit card companies, etc., by pressing the **PHONE** button to temporarily make the phone touch-tone compatible. To get information about your bank account, for example, you would:

1. Call the bank's information line.
2. Press the **PHONE** button (  ) after your call is answered.
3. Follow the voice instructions to complete your transaction.
4. Hang up when finished. The phone returns to Pulse (rotary) service.

## PAGING THE HANDSET

Press the **PAGE/FIND** button on the base to get the attention of the person using the phone or to locate a misplaced handset.

Press and release PAGE/FIND button. The handset will ring three times and the display will show "*paging you.*"

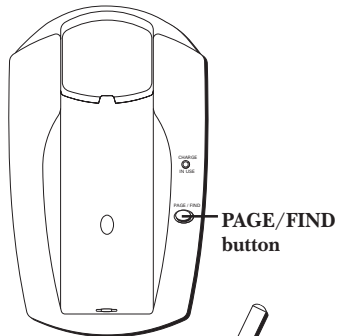

## RINGER SWITCH

The **RINGER** switch must be **ON** for the handset to ring during incoming calls.

## VOLUME SWITCH

This switch controls the volume of the handset's earpiece. There are two settings: normal and high.

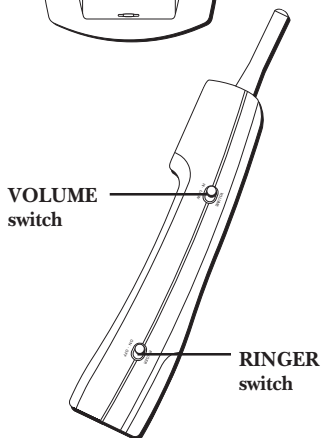

# CALLER ID OPERATION

---

**VERY IMPORTANT:** The Caller ID feature of this product requires a subscription to Caller ID service from your telephone company.

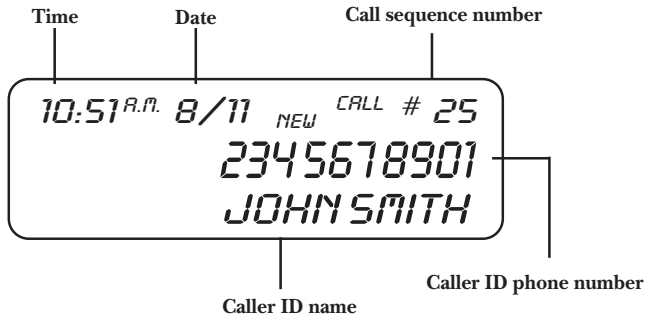

This caller ID cordless telephone receives and displays information transmitted by your local phone company. This information can include the phone number, date and time; *or* the name, phone number, date and time.

## RECEIVING AND STORING CALLS

When you receive a call, the information is transmitted by the phone company to your caller ID telephone between the first and second ring.

- You can monitor the information as it is displayed and decide whether or not to answer the call.
- If you are not at home, the telephone stores the information so that you can see who called while you were out.

**Note:** The Caller ID memory holds 25 names and numbers. When the memory is full, only the most recent calls are stored. The oldest stored number in memory is deleted to make room for the newest call, which will be designated as call #25 in the Caller ID display.

## REVIEWING MESSAGES

As calls are received and stored, the display is updated to let you know how many calls have been received.

- Press the arrow up ▲ button to begin with the oldest call and scroll toward more recent calls (higher numbers).
- Press the arrow down ▼ button to begin with the most recent call and scroll toward older calls (lower numbers).

As you review calls, the display shows you the following information:

- ...the telephone number of the caller
- ...the number of the call, with regard to the order received
- ...the name of the caller, if this service is available in your area
- ...time and date the call was received.

If the number does not fit in the display, press **ENTER** to see the rest of the Caller ID information.

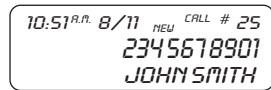

*This caller ID record shows that John Smith called at 10:51 a.m. on August 11. This is the 25th call stored in memory and it is a new call.*

**NOTE:** Check with your local phone company regarding name service availability.

## MESSAGE ERRORS

- If there is an error in the transmission of information to your caller ID phone, *CALLER ID ERROR* appears in the display.
- If you have not subscribed to Caller ID service or it is not working, *NO CALLER ID* will show in the display.



## DIALING A CALLER ID NUMBER

- Make sure the phone is **OFF**.
- Use the arrow buttons to display the desired caller ID record.
- Press the **CALL BACK** button if the number is local.
- Press the **#** key (**DIAL 1+**) to dial a long distance number or a number that requires you to dial "1" for proper connection.



## DELETING CALLER ID RECORDS

To delete only the record in the display:

1. Press ▲ or ▼ to review CID records.
2. Select the record to delete.
3. Press **DELETE**.

The display asks you to confirm the deletion.

4. Press **DELETE** again to erase the record.

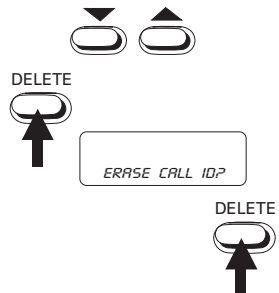

To delete all the records in memory:

1. Press ▲ or ▼ to review CID records.
2. Select the record to delete.
3. Press and hold **DELETE**.

The display asks you to confirm that you want to erase all records.

4. Press **DELETE** again to erase all records.

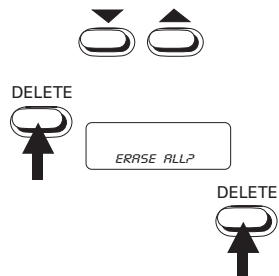

# SPECIAL FEATURES

## CALL WAITING WITH CALLER ID

Provided your telephone company is able to integrate Caller ID and Call Waiting services, you will see who is calling you when you hear the call waiting beep. The caller identification information appears in the display after you hear the tone.

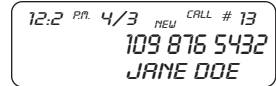

- Press the **FLASH** button to put the person to whom you're talking on hold and answer the incoming call.

FLASH



## STORING NAMES AND NUMBERS

You can store up to 10 numbers in memory for quick dialing. This memory feature is in addition to the 25 caller ID records and the 5 VIP records that can occupy memory space.

The phone must be OFF when you store numbers.

1. Press the **MEMORY** button.

The display prompts you to "Enter Name."

2. Press **ENTER**.

3. Use the keypad to store a name. More than one letter is stored in each of the number keys. For example, to enter *Joe Smith*: press 5 for J; press 6 three times for O; press 3 two times for E; press 1 to enter a space before you start entering the last name; press 7 four times for S; press 6 for M; press 4 three times for I; press 8 for T; and 4 two times for H.

MEMORY



ENTER

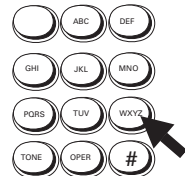

- If you are using two letters consecutively that are stored in the same number key, you must press **ENTER** between the letters. For example, if you enter Barb, press 2 two times for

ENTER





B; press **ENTER**; press 2 for A; 7 three times for R; and 2 two times for B. You need to press enter between the B and the A since they are stored within the same number key.

**NOTE:** To enter characters other than letters, press and scroll through the choice available on numbers 1,2,3,4,5,6 and 8.

#### 4. Press **MEMORY**.

The display prompts you to *"Enter Tel Number."*

5. Use the keypad to enter the number you want to store (up to 24 digits).

6. Press **MEMORY** and then press a number key (0-9) to store the dialed number in that memory location.

7. Record whose number is stored in the location on the memory directory card on the back of the handset. You will also be able to view the name and number in the display.

**NOTE:** If you do not want to enter the name, skip Step 3.

### INSERTING A PAUSE IN THE DIALING SEQUENCE

Press the **FLASH** button to insert a delay in the dialing sequence of a stored telephone number when a pause is needed to wait for a dial tone - for example, after you dial 9 for an outside line or to wait for a computer access tone. Each pause counts as 1 digit in the dialing sequence.

**TIP:** If you make a mistake while storing names and numbers, you can use the **DELETE** button to backspace and correct errors.

MEMORY



MEMORY



FLASH



**VERY IMPORTANT:** If you make test calls to emergency numbers stored in memory, remain on the line and briefly explain the reason for the call to the dispatcher. Also, it is a good idea to make these calls in off-peak hours, such as early morning or late evening.

## CHANGING A STORED NUMBER

Use the same procedure to change a stored number as you do to store a number—in a sense, you are just reassigning the memory location.

## DIALING A STORED NUMBER

1. Make sure the phone is **ON** by pressing the **PHONE** button.
2. Press **MEMORY**
3. Press the number (0-9) for the desired memory location **OR** use the arrow buttons to scroll through the numbers stored in memory and press **CALL BACK** when you reach the desired number.



## CHAIN DIALING FROM MEMORY

Use this feature to make calls that require a sequence of numbers, such as a calling card number used for a frequently called long distance number. The following example shows how you can store each part of the long dialing sequence and use chain dialing to make a call through a long distance service:

The Number For	Memory Location
Long distance access number	7
Authorization code	8
Frequently called long distance number	9

1. Make sure the phone is **ON**.
2. Press **MEMORY** and then press 7.
3. When you hear the access tone, press **MEMORY** and then press 8.
4. At the next access tone, press **MEMORY** and then 9.

**TIP:** Wait for the access tones before pressing the next memory button or your call might not go through.

## REVIEWING AND DELETING STORED NUMBERS

1. Press **MEMORY**
2. While the entry is displayed, press the **DELETE** key to delete the entry.  
The display asks you to confirm that you want to delete the entry.
3. Press **DELETE** a second time to delete the entry.

To exit the memory review mode, press **MEMORY**.

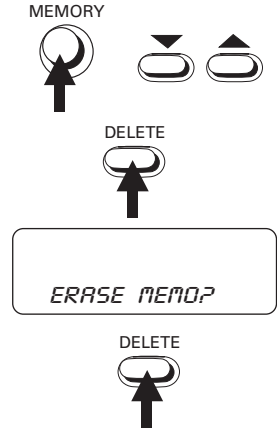

## VERY IMPORTANT PERSON (VIP) FEATURE

You can designate 5 Caller ID records as VIP. Each time someone on the VIP list calls, you will hear a distinct ring.

### STORING A VIP NUMBER IN MEMORY

1. Use the arrow buttons to scroll through the Caller ID records for desired number.
2. Press **VIP**.
3. Press **ENTER**.

The phone emits 2 beeps to confirm it has transferred the number from Caller ID memory into VIP memory.

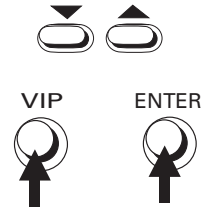

### CALLING A VIP NUMBER

1. Press the **VIP** button.
2. Use the arrow buttons to scroll through the VIP list.



- When you see the desired name/number in the display, press **CALL BACK** for local calls.

If the VIP number is long distance, just press # (**DIAL 1+**). # automatically enters the "1" needed to complete a long distance call.



### REMOVING A VIP NUMBER

- Press **VIP**.
- Use the arrow buttons to scroll through the VIP list.
- When you see the desired name/number in the display, press **DELETE**.

**Note:** If name information is not in the caller ID record, the name will not be stored in the memory location.

- ERASE CALLER ID?* appears in the display. Press **DELETE** again.

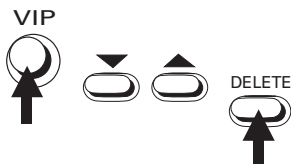

### ERASING ALL VIP NUMBERS

- Press **VIP** and the arrow keys.
- Press and hold the **DELETE** button.
- ERASE ALL VIP?* appears in the display.
- Press **DELETE** again.

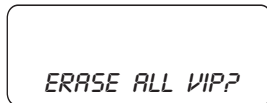
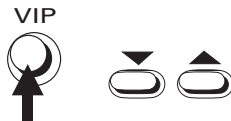

## VOICE MESSAGING

Provided your phone company offers voice messaging service and you subscribe to it, the CHARGE/IN USE light on the base will flash when the phone is not in use to indicate there is a message waiting. It will stop flashing after the message has been reviewed.

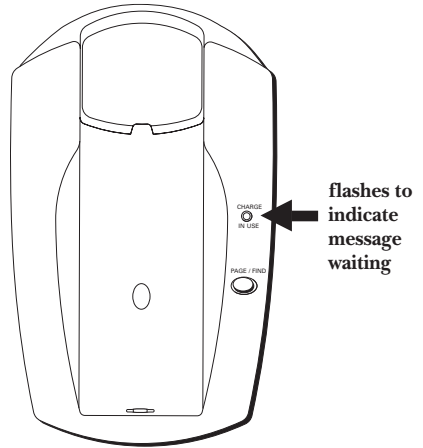

## BATTERY SAFETY PRECAUTIONS

- Do not disassemble, mutilate, puncture, wet, or dispose of battery in fire. Like other batteries of this type, if it is burned or punctured, it could release toxic materials which can cause injury.
- Keep batteries out of the reach of children.



**NOTE:** The RBRC seal on the battery used in your Thomson Consumer Electronics product indicates that we are participating in a program to collect and recycle Nickel Cadmium batteries throughout the United States of America. Please call 1-800-8-BATTERY for information or contact your local recycling center.

## GENERAL PRODUCT CARE

---

To keep your telephone working and looking good, follow these guidelines:

- Avoid putting the phone near heating appliances and devices that generate electrical noise (for example, motors or fluorescent lamps).
- DO NOT expose to direct sunlight or moisture.
- Avoid dropping the handset, as well as other rough treatment to the phone.
- Clean the phone with a soft cloth.
- Never use a strong cleaning agent or abrasive powder because this will damage the finish.
- Retain the original packaging in case you need to ship the phone at a later date.
- Periodically clean the charge contacts on the handset and base with a soft cloth.

**VERY IMPORTANT:** Because cordless phones operate on electricity, you should have at least one phone in your home that is not cordless, in case the power in your home goes out.

# MESSAGE INDICATORS

The following indicators show the status of a message or the unit.

CALLER ID ERROR	Caller information has been interrupted during transmission or the phone is excessively noisy.
ENTER AREA CODE	Prompt telling you to enter your area code.
ENTER NAME	Prompt telling you to enter name into VIP memory or one of the 10 memory locations.
ERASE ALL?	Prompt asking you if you want to erase all Caller ID records.
ERASE ALL VIP?	Prompt asking you if you want to erase all 5 VIP records.
ERASE CALL ID?	Prompt asking you if you want to erase the current Caller ID record or VIP record that is shown on the display.
ERASE MEMO?	Prompt asking you if you want to erase one of the 10 numbers stored in the phone's outgoing memory.
MESSAGE WAITING	Somebody left a voice mail message. Note that voice mail is a subscription service; check with your local telephone company for availability.
NEW	Number of new calls since you last reviewed your messages.
OUT OF AREA	The incoming call is from an area not serviced by Caller ID or the information was not sent
PAGING YOU	Someone is pressing the PAGE button.
PRIVATE	The person is calling from a number that has been blocked from caller ID transmission.
REPT	Repeat call message. Indicates that a new call from the same number was received more than once.
NO CALLER ID	There is an incoming call, but you have not ordered Caller ID service or it is not working properly.

# TROUBLESHOOTING TIPS

---

## CALLER ID

### PROBLEM

*No Display*

### SOLUTION

- Try replacing the battery.
- If you are using AC power, make sure that the unit is connected to a non-switched electrical outlet. Disconnect the unit from the plug and plug it in again.

*Data Error Message*

- The unit displays this message if it detects anything other than valid Caller ID information during the silent period after the first ring. This message indicates either the presence of noises on the line, or that an invalid message has been sent from the telephone company.



## CALL WAITING

### PROBLEM

*You hear call waiting tone but number does not appear in display.*

### SOLUTION

- You must subscribe to Call Waiting for this feature to work.
- Even if you have subscribed to both Call Waiting and Caller ID, you must call your phone company and tell them to integrate your Call Waiting and Caller ID services.



## TELEPHONE

### PROBLEM

*No dial tone*

### SOLUTION

- Check installation:



- Is the base power cord connected to a working outlet?
- Is the **PHONE** light on?
- Is the telephone line cord connected to the base unit and the wall jack?
  - Disconnect the base from the wall jack and connect another phone to the same jack. If there is no dial tone in the second phone, the problem might be your wiring or local service.
  - Is the handset out of range of the base?
  - Make sure the battery is properly charged (12 hours).
  - Is the battery pack installed correctly?
  - Did the handset beep when you pressed the **PHONE** button? Did the Phone-in-Use light come on? The battery may need to be charged.

*Dial tone is OK, but can't dial out*

- Make sure the **TONE/PULSE** switch on the base is correctly set.

*Handset does not ring*

- Make sure the **RINGER** switch on the handset is turned to **ON**.
- You may have too many extension phones on your line. Try unplugging some phones.
- See solutions for "No dial tone."

*# button does not work*

- Make sure phone is set to **TONE**.

*You experience static, noise, or fading in and out*

- Change channels
- Is handset out of range? Move closer to the base.

- Does the base need to be relocated?
- Charge battery.
- Make sure base is not plugged into an outlet with another household appliance.

### *Unit beeps*

- Place handset in base for 20 seconds to reset the security code. If that doesn't work, charge battery for 12 hours.
- Clean charging contacts on handset and base with a soft cloth, or an eraser.
- See solutions for "No dial tone."
- Replace battery.

### *Memory Dialing*

- Did you program the memory location keys correctly?
- Did you follow the proper dialing sequence?
- Make sure **TONE/PULSE** switch is correctly set.
- Did you reprogram numbers into memory after power outage or replacing battery?

## **BATTERY**

If you experience any of the following problems, even after fully recharging the battery, you may need to replace the battery pack:

- Short talk time
- Poor sound quality
- Limited range
- **CHARGE/IN USE** light fails to light

## CALLER ID / CALL WAITING / VOICE MESSAGING

*One, two or all services  
do not work*

- Check with your telephone company to make sure all services are programmed on your telephone line.
- Check to make sure your telephone company is capable of integrating Caller ID with Call Waiting.

## CAUSES OF POOR RECEPTION

---

- Aluminum siding on the building
- Foil backing on building insulation
- Heating ducts and other metal construction can shield radio signals
- You're too close to appliances such as microwaves, stoves, computers, etc.
- Atmospheric conditions, such as strong storms
- Base is installed in the basement or lower floor of the house
- Base is plugged into an AC outlet with other electronic devices
- Baby monitor is using the same frequency

## SERVICE

---

The FCC requires this product to be serviced only by the manufacturer or its authorized service agents. In accordance with FCC requirements, changes or modifications not expressly approved by Thomson Consumer Electronics could void the user's authority to operate this product. For instructions on how to obtain service, refer to the warranty included in this Guide.

Attach your sales receipt to the booklet for future reference or jot down the date this product was purchased or received as a gift. This information will be valuable if service should be required during the warranty period.

Purchase date \_\_\_\_\_      Name of store \_\_\_\_\_

# ACCESSORY ORDER FORM

DESCRIPTION	CATALOG NUMBER	PRICE*	QUANTITY	TOTAL
Replacement handset battery	BT-12	\$9.95		
AC power supply adapter	5-2385	\$20.00		

\*Prices are subject to change without notice.  
 Total Merchandise.....\$\_\_\_\_\_

**For credit card purchases**

Your complete charge card number, its expiration date and your signature are necessary to process all charge card orders.

Copy your complete account number from your **VISA** card.

<input type="text"/>	<input type="text"/>	<input type="text"/>	<input type="text"/>	<input type="text"/>	<input type="text"/>	<input type="text"/>	<input type="text"/>	<input type="text"/>	<input type="text"/>
----------------------	----------------------	----------------------	----------------------	----------------------	----------------------	----------------------	----------------------	----------------------	----------------------

My card expires:

<input type="text"/>	<input type="text"/>
----------------------	----------------------

Copy your complete account number from your **MasterCard**.

<input type="text"/>	<input type="text"/>	<input type="text"/>	<input type="text"/>	<input type="text"/>	<input type="text"/>	<input type="text"/>	<input type="text"/>	<input type="text"/>	<input type="text"/>
----------------------	----------------------	----------------------	----------------------	----------------------	----------------------	----------------------	----------------------	----------------------	----------------------

Copy the number above your name on the **MasterCard**

<input type="text"/>	<input type="text"/>	<input type="text"/>	<input type="text"/>
----------------------	----------------------	----------------------	----------------------

My card expires:

<input type="text"/>	<input type="text"/>
----------------------	----------------------

We are required by law to collect the appropriate sales tax for each individual state, county, and locality to which the merchandise is being sent.

Sales Tax..... \$\_\_\_\_\_

Use **VISA** or **MasterCard** preferably. Money order or check must be in U.S. currency only. No C.O.D. or Cash.

All accessories are subject to availability. Where applicable, we will ship a superseding model.

Shipping, Handling, and Insurance..... \$\_\_\_\_\_

Total Amount Enclosed.....\$\_\_\_\_\_

Mail order form and money order or check (in U.S. currency) made payable to Thomson Consumer Electronics, Inc. to:

**Consumer Electronics**  
**Mail Order Department**  
**P.O. Box 8419**  
**Ronks, PA 17573-8419**

This is your return label. Please print clearly.

To:

Name \_\_\_\_\_ Apt. \_\_\_\_\_  
 Address \_\_\_\_\_  
 City \_\_\_\_\_ State \_\_\_\_\_ ZIP \_\_\_\_\_

Authorized Signature \_\_\_\_\_

Please make sure that this form has been filled out completely.

CUSTOMER: CUT ALONG DOTTED LINE.



# INDEX

---

## A

Accessory Order Form 28  
Area Code 10

## B

Battery 9, 26  
Battery Safety Precautions 22

## C

Call Waiting 4, 24  
Call Waiting with Caller ID 16  
Caller ID 4, 24  
CALLER ID ERROR 23  
Caller ID Operation 13  
Caller ID with Call Waiting 4  
Caller ID/Call Waiting/Voice Messaging 27  
Calling a VIP Number 19  
Causes of Poor Reception 27  
Chain Dialing from Memory 18  
Changing a Stored Number 18  
Channel button 11

## D

Deleting Caller ID Records 15  
Deleting Stored Numbers 19  
Desktop Installation 7  
Dialing a Caller ID Number 15  
Dialing a Stored Number 18

## E

ENTER AREA CODE 23  
ENTER NAME 23  
ERASE ALL VIP? 23  
ERASE ALL? 23  
ERASE CALL ID? 23  
ERASE MEMO? 23  
Erasing all VIP numbers 20

## F

FCC Registration Information 2  
Flash button 11

## G

General Product Care 22

## H

Handset Sound Signals 5  
Hearing Aid Compatibility 2

## I

Inserting a Pause in the Dialing Sequence 17  
Installation and Setup 6  
Installing the Battery 9  
Interference Information 2  
Introduction 4

## L

Limited Warranty 31

## M

Making a Call 11  
Message Errors 14  
Message Indicators 23  
MESSAGE WAITING 23  
Modular Jack Requirements 6

## N

NEW 23  
NO CALLER ID 23

## O

OUT OF AREA 23  
Out of range warning 5

## P

Page signal 5

Paging the Handset 12

PAGINGYOU 23

Pause 17

Phone light 11

PRIVATE 23

## **R**

Receiving a Call 11

Receiving and Storing Calls 13

Redial 11

Removing a VIP number 20

REPT 23

Reviewing and Deleting Stored Numbers  
19

Reviewing Messages 14

Ringer Switch 12

## **S**

Service 27

Setting the Area Code for Caller ID 10

Setup 6

Signals an incoming call 5

Special Features 16

Storing a VIP number in memory 19

Storing Numbers in Memory 16

## **T**

Telephone 24

Telephone Operation 11

Telephone Setup 10

Temporary Tone 12

Troubleshooting Tips 24

## **V**

Very Important Person (VIP) Feature 19

Voice Messaging 4, 21

Volume Switch 12

## **W**

Wall Mount Installation 8

# LIMITED WARRANTY

---

What your warranty covers:

- Any defect in materials or workmanship.

For how long after your purchase:

- One year.

(The warranty period for rental units begins with the first rental or 45 days from date of shipment to the rental firm, whichever comes first.)

What we will do:

- Provide you with a new or, at our option, a refurbished unit.
- The exchange unit is under warranty for the remainder of the original product's warranty period.

How to make a warranty claim:

- Properly pack your unit. Include any cables, etc., which were originally provided with the product. We recommend using the original carton and packing materials.
- Include in the package evidence of purchase date such as the bill of sale. Also print your name and address and a description of the defect. Send standard UPS or its equivalent to:

- Pay any charges billed to you by the Exchange Center for service not covered by the warranty.
- Insure your shipment in case of loss or damage. Thomson accepts no liability in case of damage or loss.
- A new or refurbished unit will be shipped to you prepaid freight.

What your warranty does not cover:

- Customer instruction. (Your Owner's Manual provides information regarding operating instructions and user controls. For additional information, ask your dealer.)
- Installation and set-up service adjustments.
- Batteries.
- Damage from misuse or neglect.
- Products which have been modified or incorporated into other products.
- Products purchased or serviced outside the USA.
- Acts of God, such as but not limited to lightning damage.

Product Registration:

- Please complete and mail the Product Registration Card packed with your unit. It will make it easier to contact you should it ever be necessary. The return of the card is not required for warranty coverage.

## **How state law relates to this warranty:**

- This warranty gives you specific legal rights, and you may have other rights which vary from state to state.

## **If you purchased your product outside the USA:**

- This warranty does not apply. Contact your dealer for warranty information.

Model 2-9773 US E/S 2  
98-20  
Printed in China

 **THOMSON CONSUMER ELECTRONICS**  
P.O. Box 1976, Indianapolis, IN 46206  
© 1998 Thomson Consumer Electronics, Inc.  
Trademark(s) ® Registered  
Marca(s) ® Registrada(s)