

SANYO

INSTRUCTION MANUAL

**2.4 GHz Multi Handsets Expandable
Cordless Telephone
with Caller ID & Visual Call Waiting**

IMPORTANT

Charge the handset battery pack a full 15-20 hours before using your cordless handset for the first time.

SANYO Canada Inc.
www.sanyocanada.com



**CLT-E30
CLT-E32
CLT-E33**

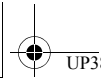
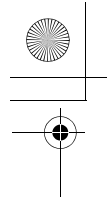

UP383BA_0.book Page 86 Thursday, May 26, 2005 10:48 AM

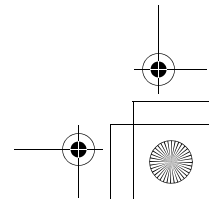
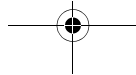
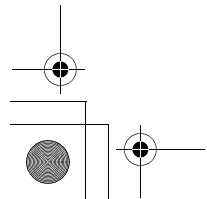
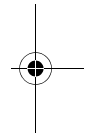
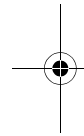
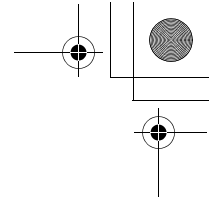

Contents

WELCOME/FEATURES/ TERMINOLOGY	E2	Speed Dialing	E55
CONTROLS & FUNCTIONS	E5	Editing or Erasing a Stored Name, Phone Number, Distinctive Ring, and Speed Dial	E55
DISPLAY AND ICONS	E7	Chain Dialing	E56
GETTING STARTED	E8	CALLER ID	E57
Setting up the Phone	E8	Caller ID and CIDCW	E57
Mounting the Base Unit on a Wall	E17	(Caller ID on Call Waiting)	E59
About the Menu Options	E20	Viewing the Caller ID List	E60
Setting Up the Menu	E25	Deleting a Caller ID Message	E61
BASICS	E35	Using the Caller ID Message List	E64
Making and Receiving Calls	E35	Call Waiting Deluxe Features	E64
Placing a Call on Hold	E37	EXPANDING YOUR PHONE	E66
Redialing a Call	E38	Expanding Your Phone	E66
Adjusting the Handset Ringer, Earpiece and Speaker Volume	E40	Connecting the Charger	E67
Mute Microphone	E41	Register the Handset to the Base	E68
Tone Dialing Switch-over	E41	Using the Walkie-Talkie (Direct-Link) Mode (for multi handsets)	E70
Traveling Out-of-Range	E42	Room Monitor (For Multi Handsets)	E71
Clarity Booster	E43	3-Way Conferencing (For Multi Handsets)	E72
Privacy Mode	E43	Intercom/Call Transfer Feature (for multi handsets)	E72
Find Handset	E44	Replacing the Base	E74
Flash and Call Waiting	E45	ADDITIONAL INFORMATION	E75
Using One Touch Voice Mail Access	E46	Changing the Digital Security Code	E75
PHONEBOOK	E48	Installing the Beltclip	E76
Phonebook	E48	Headset Installation	E76
Storing Phone Numbers, Names, Distinctive Rings, and Speed Dial	E48	Note on power sources	E77
Steps for Entering Names and Special Characters	E51	Troubleshooting	E78
Viewing the Phonebook	E53	Technical Information	E81
Making Calls Using the Phonebook	E54	THE SANYO COMFORT WARRANTY	E83
		SOS HELP LINE	E85

GETTING
STARTED

BASICS

PHONEBOOK

CALLER ID

EXPANDING
YOUR PHONE

ADDITIONAL
INFORMATION

Welcome

Congratulations on your purchase of the SANYO Multi-Handset Expandable Cordless System telephone. This unit is different from conventional cordless telephones. When the base unit is connected to AC power and a telephone line, it can support up to 4 handsets. Using extra handsets, you can establish a 3-way conference call (2 handsets and an outside line), while two other handsets are making an intercom call. You can now place a fully featured cordless handset anywhere in your home or office where AC power is available to connect the handset chargers.

Note:

Some illustrations in this manual may differ from the actual unit for explanation purposes.

Features

- 2.4GHz Frequency Hopping Spread Spectrum
- 4 Multi-Handset Expandability
- Hands Free Speakerphone in the Handset
- Call Waiting Deluxe
- Caller ID/Caller ID On Call Waiting
- 100 Dynamic Memory Location (Phonebook & Caller ID)
- Trilingual Handset Display Menus (English, French, and Spanish)

[E2] Welcome/Features/Terminology

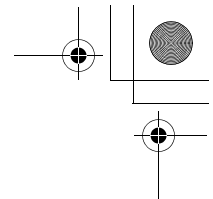
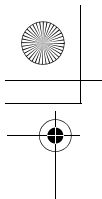

- Call Transfer between Handsets (for multi handsets)
- 20 Distinctive Ring Options (10 ringer tones and 10 melody ringers)
- Mute Feature
- Flash and Pause
- 88 Channel Auto Scan
- Walkie-Talkie Mode (for multi handsets)
- Voice Mail Access
- Room Monitoring Feature (for multi handsets)
- Battery Level Indicator
- Clock Display

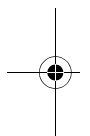

This series includes **Automatic Talk** and **Automatic Standby** features. Automatic Talk allows you to answer a call by just removing the handset from the cradle. Automatic Standby allows you to hang up by simply returning the handset to the cradle.

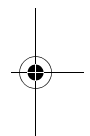

Frequency Hopping Spread Spectrum (FHSS) technology improves calling range and clarity, and eliminates cross talk. Because of rapid changes in transmission frequencies within the 2.4GHz bandwidth, this cordless phone helps reduce the possibility of eavesdropping.

Walkie-Talkie mode is used when you have 2 or more handsets. You can use your handsets as transceivers.

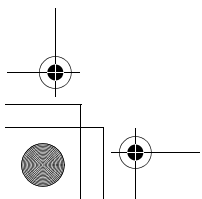

Welcome/Features/Terminology [E3]

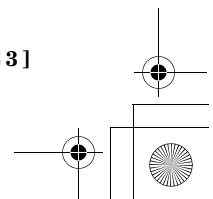
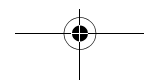

Terminology

- **Standby Mode** - The handset is not in use and *talk/flash* has not been pressed.
- **Talk Mode** - The handset is not in the cradle and *talk/flash* or *speaker* has been pressed enabling a dial tone. Talk appears on the display.

Checking the package contents

Make sure you have received the following items in the package.

- | For CLT-E30; | For CLT-E32; | For CLT-E33; |
|--|--|--|
| <ul style="list-style-type: none">• Base unit (1)• Handset (1)• AC adapter AD-800 (1)• Rechargeable battery BT-446 (1)• Telephone cord (1)• Belt clip (1)• This instruction manual | <ul style="list-style-type: none">• Base unit (1)• Charging cradle (1)• Handset (2)• AC adapter AD-800 (1)• AC adapter AD-210 (1)• Rechargeable battery BT-446 (2)• Telephone cord (1)• Belt clip (2)• This instruction manual | <ul style="list-style-type: none">• Base unit (1)• Charging cradle (2)• Handset (3)• AC adapter AD-800 (1)• AC adapter AD-210 (2)• Rechargeable battery BT-446 (3)• Telephone cord (1)• Belt clip (3)• This instruction manual |

[E4] Welcome/Features/Terminology

Controls & Functions

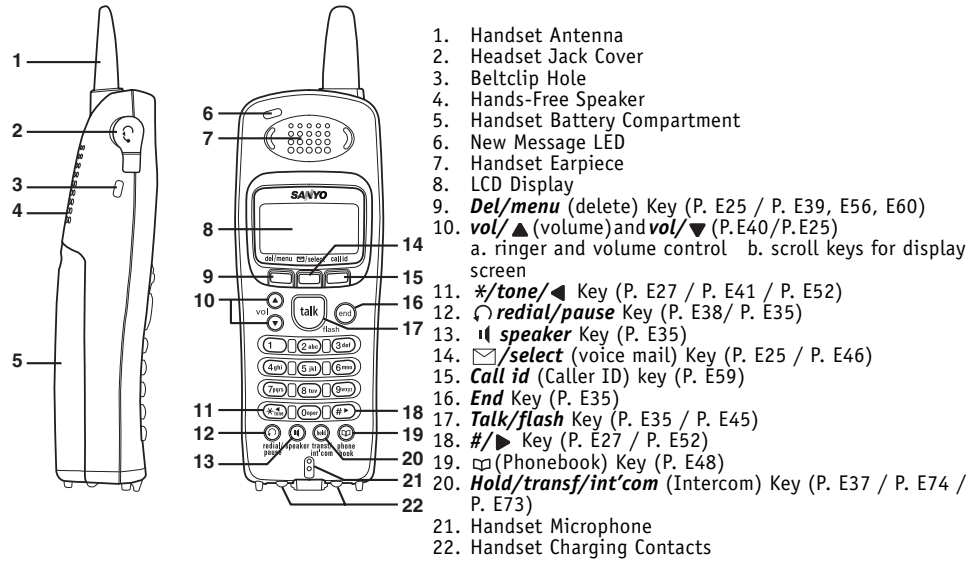

Controls & Functions [E5]

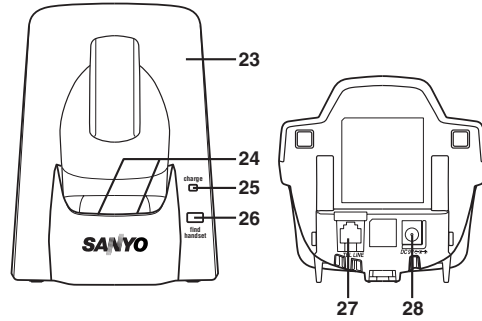

- 23. Base Antenna
- 24. Base Charging Contacts
- 25. Charge LED
- 26. Find handset Key (P. E44)
- 27. TEL LINE Jack
- 28. DC IN 9V Jack

For multi-handset packs only

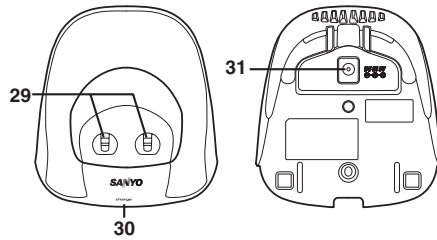

- 29. Charging Contacts
- 30. Charge LED
- 31. DC IN 9V Jack

[E6] Controls & Functions

Display and Icons

Example of the Standby Mode display

SUN 12:00A	■	Day of the week and time / battery icon
Handset #1		Handset ID and Banner
New: 5	⏸	Number of new Caller ID calls received / Ringer off icon (when the ringer is Off)

ICON	STATUS	DESCRIPTION
	Standby/Talk	Battery icons indicate the handset battery status (empty, low, medium, and full).
	Standby	Ringer off icon indicates that ringer is turned off.
	Talk	Mute icon appears when you mute the handset.
	Talk	Speaker icon appears when the handset speaker phone is used.
	Talk	Booster icon appears when the Clarity Booster feature is in use.
	Talk	Privacy icon appears when the Privacy Mode is turned on.

Display and Icons [E7]

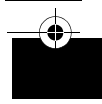
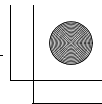
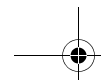
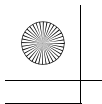

GETTING STARTED

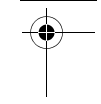

Setting up the Phone

- Do the following steps:**
- A. Choose the best location.
 - B. Install the rechargeable battery pack into the handset.
 - C. Connect the base unit.
 - D. Choose the dialing mode.

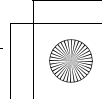
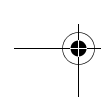
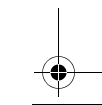
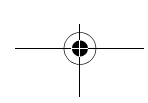
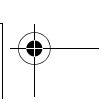
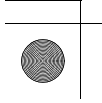
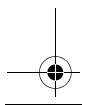
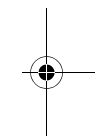
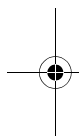

GETTING STARTED

A. Choose the best location

When choosing a location for your new phone, here are some important guidelines you should consider:

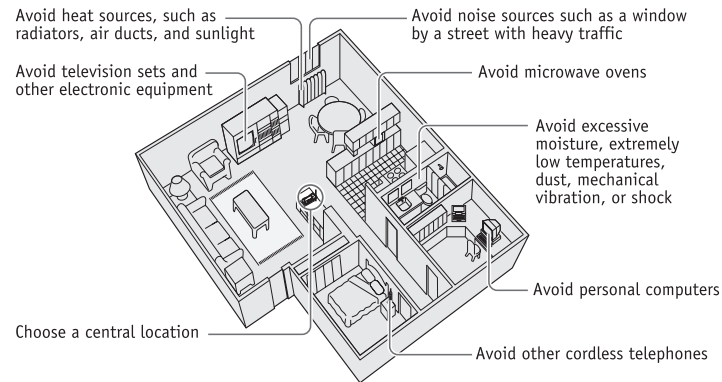

Notes:

- If your home has specially wired alarm equipment connected to the telephone line, be sure that installing the system does not disable your alarm equipment.
- If you have questions about what will disable alarm equipment, contact your telephone company or a qualified installer.

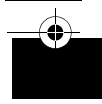
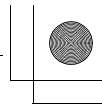
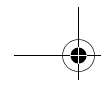
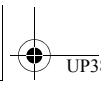
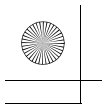

GETTING STARTED

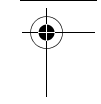

B. Install the rechargeable battery pack into the handset

Charge the handset battery pack for at least 15-20 hours before using your new cordless telephone for the first time! The handset is powered by a rechargeable battery pack. The battery recharges automatically when the handset is placed in the base unit. To maximize the charge capacity of your battery pack, DO NOT plug the telephone cord into the base unit and wall jack until the battery is fully charged.

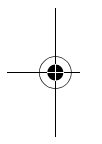

Important:

Use only the SANYO rechargeable battery pack supplied with your cordless telephone.

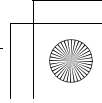
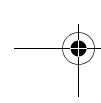
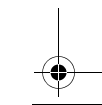
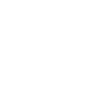
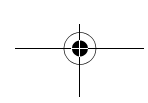
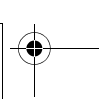
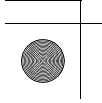
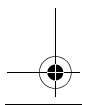
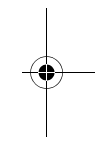

GETTING STARTED

- 1) Press down on the handset battery case cover (use the finger indentation for a better grip) and slide the cover downward to remove.
- 2) Plug the battery pack connector (red & black wires) into the jack inside the battery compartment (the connector notches fit into the grooves of the jack only one-way). Match the wire colors to the polarity label in the battery compartment, connect the battery, and listen for a click to insure connection.
- 3) Make sure you have a good connection by slightly pulling on the battery wires. If the connection is secure, the battery jack will remain in place.
- 4) Place the battery case cover back on the handset by sliding it upwards until it clicks into place.
- 5) Place the handset in the base unit for 15-20 hours without interruption. The base unit's LED light (labeled charge) illuminates once the handset is placed in the base. The LED light will illuminate whether the battery pack is connected or not.

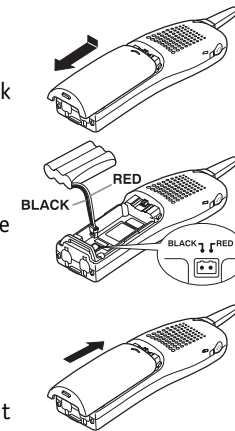

If the base **charge** LED light does not illuminate:

- Check to see if the AC adapter is plugged into the base unit and the electrical wall outlet properly (use only the supplied AC adapter. Do not use any other AC adapter).
- Check to see if the handset is sitting correctly in the base and making good contact with the base unit's charging contacts.

Getting Started [E11]

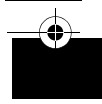
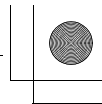
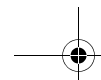
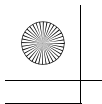

GETTING STARTED

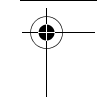

Low battery alert

When the battery pack is very low and needs to be charged, the phone is programmed to eliminate functions in order to save power.

The battery pack needs to be charged when:

- The empty battery icon appears.
- Low Battery appears in the display.

If the phone is in standby mode, none of keys will operate. If you are on a call, complete your conversation as quickly as possible, and return the handset to the cradle.

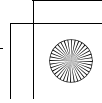
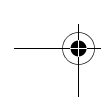
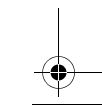
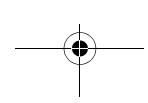
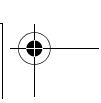
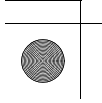
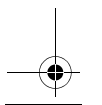
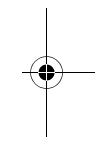
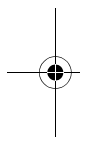
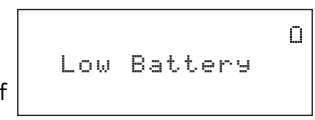

GETTING STARTED

Cleaning the battery charging contacts

To maintain a good charge, it is important to clean the charging contacts on both the handset and the base unit once a month. Use a clean pencil eraser or superfine steel wool. Avoid touching the cabinet area of the phone or scratches may occur.

Caution: Do not use paint thinner, benzene, alcohol, or other chemical products. Doing so may discolor the surface of the telephone and damage the finish.

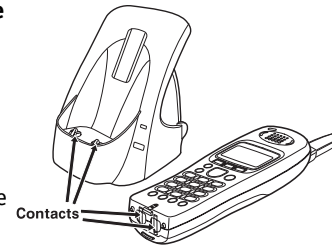

GETTING STARTED

C. Connect the base unit

- 1) Connect the AC adapter to the **DC IN 9V** jack and to a standard 120V AC wall outlet.

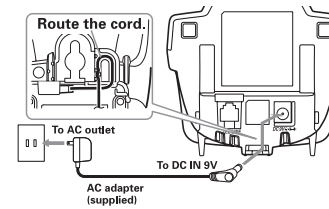

- 2) Set the base on a desk or tabletop, and place the handset in the base unit.
- 3) Make sure that the **charge** LED illuminates.
If the LED does not illuminate, check to see that the AC adapter is plugged in and the handset makes good contact with the base charging contacts.



[E14] Getting Started

GETTING STARTED

- Use only the supplied SANYO AC adapter. Do not use any other AC adapter.

Notes:

- Connect the AC adapter to a continuous power supply.
- Place the base unit close to the AC outlet so that you can unplug the AC adapter easily.

Important:

- Place the power cord so that it does not create a trip hazard or where it could become chafed and create a fire or electrical hazard.
- After installing the battery pack in the handset, charge your handset at least **15-20 hours before plugging into the phone line.**

- 4) Once the handset battery pack is fully charged, connect the telephone line cord to the **TEL LINE** jack and to a telephone outlet.

Tip:

If your telephone outlet isn't modular, contact your telephone company for assistance.

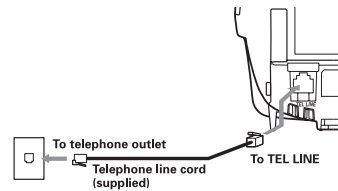

Getting Started [E15]

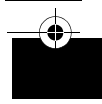
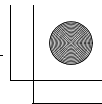
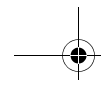
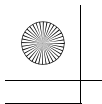

GETTING STARTED

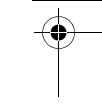

D. Choose the dialing mode

Most phone systems use tone dialing, which sends DTMF tones through the phone lines. However, some phone systems still use pulse dialing such as in rural areas. The default setting is tone dialing. Depending on your dialing system, set the dial mode. To set the dial mode, see "Setting the Dial Mode" on page E32.

- If you are not sure of your dialing system, set the unit to tone dialing. Make a trial call. If the call connects, leave the setting as is, otherwise set the unit to pulse dialing.
- If your phone system requires pulse dialing and you need to send DTMF tones in certain situations during a call, you may Switch Over to tone dialing (refer to "Tone Dialing Switch-over" on page E41).

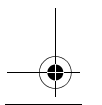
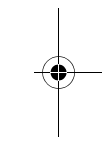
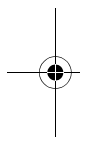

[E16] Getting Started

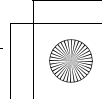
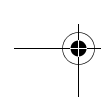
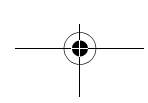
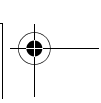
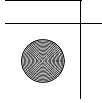
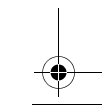

GETTING STARTED

Mounting the Base Unit on a Wall

Standard wall plate mounting

This phone can be mounted on any standard wall plate.

- 1) Plug the AC adapter into the **DC IN 9V** jack.
- 2) Wrap the AC adapter cord inside the molded wiring channel as shown.
- 3) Plug the AC adapter into a standard 120V AC wall outlet.
- 4) Plug the telephone line cord into the **TEL LINE** jack. Wrap the cord inside the molded wiring channel as shown.
- 5) Plug the telephone line cord into the telephone outlet.

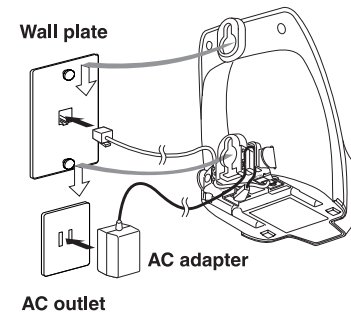

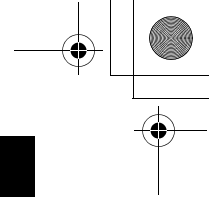
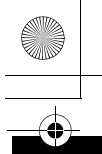

GETTING STARTED

6) Align the mounting slots on the base with the mounting posts on the wall. Then push in and down until the phone is firmly seated.

Important:

DO NOT use an AC outlet controlled by a wall switch.

Direct wall mounting

If you don't have a standard wall plate, you can mount your phone directly to the wall. Before doing this, consider the following:

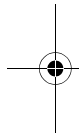

- Avoid electrical cables, pipes, or other items behind the mounting location that could cause a hazard when inserting screws into the wall.
- Try to mount your phone within 5 feet of a working phone jack to avoid excessive lengths.
- Make sure the wall material is capable of supporting the weight of the base and handset.
- Use #10 screws (minimum length of 1-3/8 inches) with anchoring devices suitable for the wall material where the base unit will be placed.

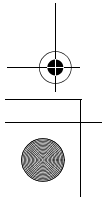
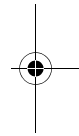

[E18] Getting Started

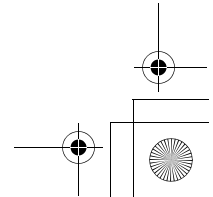
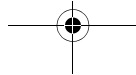

GETTING STARTED

- 1) Insert two mounting screws into the wall (with their appropriate anchoring device), 3-15/16 inches apart. Allow about 1/8 of an inch between the wall and screw heads for mounting the phone.
- 2) Refer to steps 1 through 6 on page E17-E18 to mount the telephone.

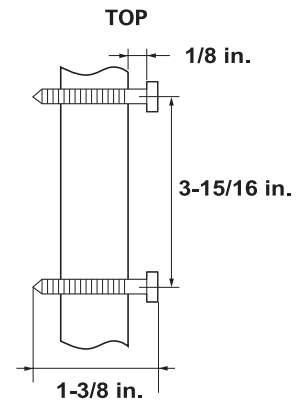

Getting Started [E19]

GETTING STARTED

About the Menu Options

There are 5 main menu options, (**Walkie-Talkie Mode, Room Monitor, Handset Setup, Global Setup** and **System Reset**) and 16 submenu options.

Note:

During Global Setup and System Reset, make sure your cordless phone is in standby mode (not in use), and all handsets are within range of the main base unit.

Summary of Main Menu and Submenu Options

Walkie-Talkie (Direct-Link) Mode (For Multi Handsets)

Walkie-Talkie Mode allows a pair of handsets to work without the base unit, for direct handset-to-handset communication. Use them at sporting events or while shopping to stay in contact with family members or friends. You must set the two handsets to Walkie-Talkie Mode to utilize this feature.

Room Monitor (for multi handsets)

This feature only works if you have two or more handsets, allowing you to monitor sounds in another room (see page E26 for setup). One handset is placed in the desired room to monitor (acts as remote mic), and the other is placed near listener (remote speaker). This is useful for monitoring child activities.

[E20] Getting Started

GETTING STARTED

Handset Setup

The following submenu options must be set separately for each handset.

Submenu option	Description
Edit Voice Mail	Program or delete the voice mail access number (see page E27).
Ringer Tones (Default is Flicker)	Adjusting the ringer tone (the sound your phone makes when ringing) (see page E28).
Distinct. Ring (Default is on)	Set the distinctive ring (see page E28). "Distinctive Ringer" allows you to preset memory locations with a designated ring tone. When an incoming call is received and the Caller ID information matches the information in one of the memory locations, the distinctive ring that has been stored for that particular Caller will sound. If you have set multiple memory locations with distinctive rings, switching the setting to "Distinctive Off" will result in no distinctive ringing. All incoming calls will have a normal ring tone. Switching to "Distinctive On" will activate all programmed distinctive ring memory locations.
Automatic Talk (Default is off)	Allows you to answer the phone without pressing <i>talk/flash</i> or <i>speaker</i> . When the Automatic Talk is set to on, simply remove the handset from the cradle and the phone automatically answers the call (see page E29).
Anykey Answer (Default is off)	Allows you to answer the phone without pressing <i>talk/flash</i> or <i>speaker</i> . When the Anykey Answer is on, you can answer a call by pressing any number key, <i>*/tone/◀</i> , or <i>*/▶</i> on the handset (see page E29).

Getting Started [E21]

GETTING STARTED

Submenu option	Description
Banner (True Banner)	Customize your handset(s) by giving it a banner name. The name will be displayed on the LCD screen during Standby Mode, Intercom, Transfer, Room Monitor and Copy Phonebook operation. The banner name will be displayed on the receiving handset as well (see page E29).
Language (Default is English)	The menu display options can be set to English, French or Spanish for easy setup use (see page E30).
Key Touch Tone (Default is on)	Allows you to set your phone's key touch-tone to on or off (the sound your keypad makes when keys are pressed) (see page E30).

[E22] Getting Started

GETTING STARTED

Global Setup

If you change one of the Global settings, you change the settings for all additional handsets. Only one handset can change Global settings at a time.

Submenu option	Description
Day & time	Set the day and time of your display (see page E30).
CIDCW (Default is CW on/CWDX off)	Set the Caller ID on Call Waiting (CIDCW) setting. CIDCW performs the same as regular Caller ID on a call waiting number (see page E31). Call Waiting Deluxe allows you to handle call waiting calls in seven different ways (see page E64).
Area Code	Store or edit the area code. If you enter a 3-digit area code number in the "Area Code" option, your local area code does not appear in the Caller ID message. For calls received from outside your local area code, you will see a full 10-digit number (see page E31). Note: If your calling area requires 10-digit dialing, do not program this option.
Dial Mode (Default is tone)	Set the dial mode to tone or pulse (see page E32). Most phone systems use tone dialing, which sends a DTMF tone through phone line.
Copy Phonebook (For Multi Handsets)	To transfer the phonebook data stored in one handset to another handset (see page E32).
Voice Mail Tone (Default is on)	If your service does not support SDT message signal, set your VMWI (Visual Message Waiting Inculcator) not to detect SDT message signal (see page E33).

Getting Started [E23]

GETTING STARTED

System Reset

System Reset is used to clear the handset's ID from the main base unit, or the base ID from the handset.

Submenu option	Description
Deregister HS	Clear the handset ID from the base. Use this option, for example, when you change the digital security code (see page E34).
Replacing Base	Clear the base ID. Use this option, for example, if you wish to deregister the base to use the handset with another base of the CLT-E series (see page E34).

GETTING STARTED

Setting Up the Menu

Entering the Menu

- 1) Press the **del/menu** key in standby mode.
- 2) Use **vol/▲** or **vol/▼** to move the pointer to a desired main menu (Walkie-Talkie Mode, Room Monitor, Handset Setup, Global Setup, and System Reset).
- 3) Press **☒/select** to select the desired main menu.
- 4) Use **vol/▲** or **vol/▼** to select a desired submenu, and then press **☒/select** to enter. In the submenu, use **vol/▲** or **vol/▼** to select an item. Press **☒/select** to confirm your selection. For detailed instructions, see the following sections for the desired submenu.
- 5) To exit the menu, press **end** or place the handset to the cradle.

```
▶ DirectLink Mode
Room Monitor
Handset Setup
```

Walkie-Talkie (Direct-Link) Mode (For Multi Handsets)

Using the Walkie-Talkie Mode

- 1) Enter the Walkie-Talkie Mode menu. To enter DirectLink mode press [SELECT] appears.

```
To enter
DirectLink mode
press [SELECT]
```

Getting Started [E25]

GETTING STARTED

- 2) Press **☒/select** to enter the Walkie-Talkie mode. You will hear a confirmation tone, and `DirectLink Mode Complete` appears.
- 3) To exit the Walkie-Talkie mode, press **del/menu**, and then **☒/select**, or return the handset to the cradle.

Room Monitor (For Multi Handsets)

Using Room Monitor

- 1) Enter the Room Monitor menu (see "Entering the Menu" on page E25).
`To Room Monitor` appears.
- 2) Select the handset you want to monitor by using **vol/▲** or **vol/▼**.
- 3) Press **☒/select**.
`RoomMonitor` appears, and you hear sounds in the room where the handset is located.
- 4) To de-select the Room Monitor, press **end** or return the handset to the cradle.

```
To Room Monitor
▶Handset #2
```

```
To Room Monitor
▶Handset #2
```

Note:

This is an example, if you have handset #1 and #2.

[E26] Getting Started

GETTING STARTED

Handset Setup

Programming your Voice Mail Access Number

- 1) Enter the Handset Setup menu, and then the Edit Voice Mail submenu (see "Entering the Menu" on page E25).
Edit V_mail No. appears.

```
Edit V_mail No.  
1234567890■
```

- 2) Enter your personal access number using the number keypad (**0-9**), ***/tone/◀**, **#/▶**, **del/menu**, or **redial/pause** (up to 20 digits).
- 3) Press **☒/select**. You will hear a confirmation tone.

To delete the current Voice Mail Access Number, in step 2 press and hold **del/menu** to delete all numbers and then press **☒/select** to confirm.

GETTING STARTED

Selecting a Ringer Tone

- 1) Enter the Handset Setup menu, and then the Ringer Tones submenu (see "Entering the Menu" on page E25).

```
Ringer Tones
▶ Flicker
Clatter
```

There are 10 ringer tones or 10 melodies to choose from.

- Ringers: Flicker, Clatter, Soft Alert, Wake Up, Light Bug, Beep Boop, Tone Board, Chip Chop, Party Clap, Reminder
- Melodies: Beethoven's Symphony #9 (Beethoven9), For Elise (Elise), We Wish You A Merry Christmas (Merry-Xmas), Home Sweet Home (Hm Swt Hm), Lorri Song #6 (Lorri Song), When the Irish Eyes Are Smiling (Irish Eyes), Aura Lee, Let Me Call You Sweet Heart (Sweetheart), Star Spangled Banner(Star Spngl), Old MacDonald(Old MacDld)

- 2) Press **vol/▲** or **vol/▼** to move the pointer. You will hear the ringer or melody as you scroll through the options.
- 3) Press **☒/select**. You will hear a confirmation tone.

Distinctive Ringer Setup

- 1) Enter the Handset Setup menu, and then the Distinct. Ring submenu (see "Entering the Menu" on page E25).
- 2) Press **vol/▲** or **vol/▼** to select **On** or **Off**.
- 3) Press **☒/select**. You will hear a confirmation tone.

```
Distinctive Ring
▶ On
Off
```

[E28] Getting Started

GETTING STARTED

Setting the Automatic Talk

- 1) Enter the Handset Setup menu, and then the Automatic Talk submenu (see "Entering the Menu" on page E25).
- 2) Press **vol/▲** or **vol/▼** to select On or Off.
- 3) Press **☒/select**. You will hear a confirmation tone.

```
Auto Talk
On
▶ Off
```

Setting the Anykey Answer

- 1) Enter the Handset Setup menu, and then the Anykey Answer submenu (see "Entering the Menu" on page E25).
- 2) Press **vol/▲** or **vol/▼** to select On or Off.
- 3) Press **☒/select**. You will hear a confirmation tone.

```
Anykey Answer
On
▶ Off
```

Setting the True Banner

- 1) Enter the Handset Setup menu, and then the Banner submenu (see "Entering the Menu" on page E25).
- 2) Use the number keypad (**0-9**), ***/tone/◀**, **#/▶**, or **del/menu** to enter or edit the name.
- 3) Press **☒/select**. You will hear a confirmation tone.

```
Banner
■----- #1
```

GETTING STARTED

Selecting a Language

- 1) Enter the Handset Setup menu, and then the Language submenu (see "Entering the Menu" on page E25).
- 2) Press **vol/▲** or **vol/▼** to choose English, Français (French), or Español (Spanish).
- 3) Press **☒/select**. You will hear a confirmation tone.

```

Language
▶English
  Français
  
```

Setting the Key Touch Tone

- 1) Enter the Handset Setup menu, and then the Key Touch Tone submenu (see "Entering the Menu" on page E25).
- 2) Press **vol/▲** or **vol/▼** to select On or Off.
- 3) Press **☒/select**. You will hear a confirmation tone.

```

Key Touch Tone
▶On
  Off
  
```

Global Setup

Setting Day and Time

- 1) Enter the Global Setup menu, and then the Day & Time submenu (see "Entering the Menu" on page E25).
- 2) Press **vol/▲** or **vol/▼** to select the day of the week, and then press **☒/select**.
- 3) Press **vol/▲** or **vol/▼** to set hour and then press **☒/select**.
- 4) Press **vol/▲** or **vol/▼** to set minute and then press **☒/select**.

```

Day & Time
SUN 12:00 AM
[←/↑/↓/→/SELECT]
  
```

[E30] Getting Started

GETTING STARTED

- 5) Press **vol/▲** or **vol/▼** to choose AM or PM, and then press **☒/select**. You will hear a confirmation tone.

Notes:

- When a Global setting is changed from one handset, this affects all registered handsets.
- For setting the day and time, the idle time-out is extended to 2 minutes.
- If you receive a call during set up the Global Setup menu, the transfer will be canceled.

Setting CIDCW (Caller ID on Call Waiting)

- 1) Enter the Global Setup menu, and then the CIDCW submenu (see "Entering the Menu" on page E25).
- 2) Press **vol/▲** or **vol/▼** to select CW On/CWDX On, CW On/CWDX Off, or CW Off/CWDX Off, and then press **☒/select**. You will hear a confirmation tone.

```
CIDCW
▶CW On /CWDX On
  CW On /CWDX Off
```

Setting the Area Code

- 1) Enter the Global Setup menu, and then the Area Code submenu (see "Entering the Menu" on page E25).
- 2) Press the number keypad (**0-9**) to enter a 3-digit area code.
- 3) Press **☒/select**. You will hear a confirmation tone.

```
Area Code
■_ _
```

Getting Started [E31]

GETTING STARTED

Note:

When the area code has already been stored in memory, the stored area code will be displayed. To change it, use *del/menu* and number keys to enter the new area code.

Setting the Dial Mode

- 1) Enter the Global Setup menu, and then the Dial Mode submenu (see "Entering the Menu" on page E25).
- 2) Press *vol/▲* or *vol/▼* to choose, *Tone* or *Pulse* (the initial setting is *Tone*).
- 3) Press *☑/select*. You will hear a confirmation tone.

```
Dial Mode
▶ Tone
Pulse
```

Copy Phonebook (For Multi Handsets)

- 1) Enter the Global Setup menu, and then the Copy Phonebook submenu (see "Entering the Menu" on page E25).
- 2) Press *vol/▲* or *vol/▼* to choose *One memory* or *All memory*, and then press *☑/select*.
If you choose *All memory*, go to step 4.
- 3) Press *vol/▲* or *vol/▼*, or the number keypad (*0-9*) to select the phonebook location you want to export, and then press *☑/select*.

```
Copy Phonebook
▶ One Memory
All Memory :xxx
```

[E32] Getting Started

GETTING STARTED

- 4) Press **vol/▲** or **vol/▼** to select the handset you want to transfer the phonebook locations to, and then press **☒/select**.

If you choose All Memory in the step 2, Are you sure? appears.
Press **vol/▲** or **vol/▼** to select Yes, and then press **☒/select**.

The phonebook locations will be transferred to the handset. On the receiving handset, Receiving and the handset name appear. When the transfer is complete, Done! appears on the handset.

Notes:

- If an error occurs, the phonebook locations transferred before the error were stored in the receiving handset. Unavailable appears on the display.
- When the memory of the receiving handset is full, Not enough memory in Receiving Handset appears. You cannot transfer the phonebook location.

Voice Mail Tone

- 1) Enter the Global Setup menu, and then the Voice Mail Tone submenu (see "Entering the Menu" on page E25).
- 2) Press **vol/▲** or **vol/▼** to set the voice message indication (SDT message signal) to On or Off.
- 3) Press **☒/select**. You will hear a confirmation tone.

```
Voice Mail Tone
▶ On
  Off
```

GETTING STARTED

System Reset

De-register the Handset

- 1) Enter the System Reset menu, and then the Deregister HS submenu (see "Entering the Menu" on page E25).
- 2) Press **vol/▲** or **vol/▼** to select the handset ID to be de-registered from the list, and then press **ⓧ/select**. Deregister HS? appears.
- 3) Press **vol/▲** to select Yes, and then press **ⓧ/select**. You will hear a confirmation tone. When de-registration is complete, Deregistration Complete appears.
- 4) After de-registering the handset, move to "Replacing the Base Setting" below.

```
Which Handset?
▶Handset   #1
Handset    #2
```

```
Deregister HS?
Yes
▶No
```

Note:

Make sure to perform the Replacing Base after de-register the handset.

Replacing the Base Setting

- 1) Enter the System Reset menu, and then the Replacing Base submenu (see "Entering the Menu" on page E25). Replace base? appears.
- 2) Press **vol/▲** to select Yes, and then press **ⓧ/select**. You will hear a confirmation tone. The base information will be deleted. When replacing the base is complete, Place handset on main base to register appears, register the handset to the new base (see page E68).

```
Replace base?
Yes
▶No
```

[E34] Getting Started

BASICS

Making and Receiving Calls

This handset has a built-in speakerphone that allows you to have a hands-free conversation. This feature allows you to communicate easily while performing other tasks, such as cooking.  appears during hands-free conversations.

You can easily switch a call from normal conversation to hands-free conversation. To switch a call, press **speaker** during the call. To return to normal conversation, press **talk/flash**.

	From the Handset	
	Normal conversation	Hands-free conversation
To answer a call	Handset On the Cradle Pick up the handset (Automatic Talk: On) or pick up the handset and press talk/flash . Handset Off the Cradle Press any number key, */tone/◀ , or */▶ (Any Key Answer: On), or press talk/flash .	Handset Off the Cradle Press speaker .
To make a call	Handset Off the Cradle 1) Press talk/flash . 2) Listen for the dial tone. 3) Dial the number. OR Dial the number, and then press talk/flash .	Handset Off the Cradle 1) Press speaker . 2) Listen for the dial tone. 3) Dial the number. OR Dial the number and then press speaker .
To hang up	Press end or return the handset to the cradle (Automatic Standby).	

BASICS

	From the Handset	
	Normal conversation	Hands-free conversation
To enter a pause within the dialing sequence		When you dial the number in standby mode, press  <i>redial/pause</i> . P appears in the display, which represents a pause.

Notes:

- To set Automatic Talk, see page E29 or to set Anykey Answer see page E29.
- The handset microphone is located at the bottom of the handset (see "Controls and Functions" on page E5). Position yourself as near to the handset as possible and speak clearly.
- If the line is in use by another handset(s), Line In Use appears in the display of all registered handset's display, that are not in use.

BASICS

Placing a Call on Hold

- 1) During a call, press **hold/transf/int'com**. The call will be put on hold.

```
Hold, to transfer
▶ Handset #2
Handset #3
```

Tip:

After 10 seconds of pressing **hold/transf/int'com** or by pressing the **end** key, the handset display screen will read, **Line On Hold**.

Notes:

- You can hold a call for 5 minutes, when 5 minutes has passed, the call is disconnected and the phone returns to standby mode.
- While a call is on hold, CIDCW can not be received.

- 2) To continue to talk to the caller, press **talk/flash** or **speaker** on a handset. The phone will return back to the call.

```
SUN 12:00A
Handset #1
Line On Hold
```

BASICS

Redialing a Call

The last three phone numbers dialed can be quickly redialed.

Notes:

- If the number exceeds 32 digits, only the first 32 digits are retained in redial memory.
- If the redial memory is empty, you will hear a beep.

Redialing from Standby Mode

- 1) Press **redial/pause** in standby mode.
- 2) Press **redial/pause** again. Each press of **redial/pause** will display one of the last three number redialed.
- 3) Press **talk/flash** or **speaker**. The selected number is dialed.
- 4) To hang up, press **end**.

Redialing from Talk Mode

- 1) Press **talk/flash** or **speaker**.
- 2) Press **redial/pause**. The last number dialed will be displayed and redialed. To hang up, press **end**.

Note:

Redialing from Talk Mode will only display the last number dialed. Use redialing from Standby Mode to display the other two numbers.

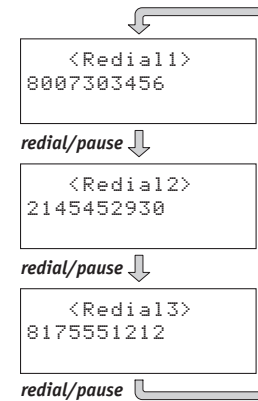

BASICS

Deleting a Redial Record

- 1) Press **redial/pause** in standby mode.
- 2) Press **redial/pause** repeatedly to display the number to be deleted.
- 3) Press **del/menu**.
- 4) Press **vol/▲** or **vol/▼** to choose **Yes**.
- 5) Press **select**. The redialed number is deleted.

```
Delete Redial1?  
▶ Yes  
No
```

Storing a Redial Record

- 1) Press **redial/pause** in standby mode.
- 2) Press **redial/pause** repeatedly to display the number to be stored.
- 3) Press **select**. **Store/Edit Name** appears.
- 4) To complete the setting, follow the steps 3-8 in "Storing Phone Numbers, Names, Distinctive Rings, and Speed dial" on page E49-E50.

BASICS

Adjusting the Handset Ringer, Earpiece and Speaker Volume

Handset ringer volume

Press the volume up key or volume down key (labeled as **vol/▲** or **vol/▼**) in standby mode to select one of three ringer volume (off, low, or high).

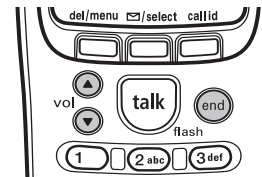

Earpiece and speaker volume

Pressing the volume up key or volume down key (labeled as **vol/▲** or **vol/▼**) during a call will change the earpiece volume of the handset. This setting will remain in effect after the telephone call has ended.

Note:

When you press volume up key (**vol/▲**) to the maximum volume level or volume down key (**vol/▼**) to the lowest volume level, an error tone sounds.

Ringer Mute

When the handset is off the cradle and the phone is ringing, you can temporarily mute the incoming ring by pressing **end**. The ringer will sound with the next incoming call.



BASICS

Mute Microphone

You can temporarily turn off the microphone so that the person you are talking with cannot hear you.

1) Press **del/menu** during talk mode (while phone is in use).

2) Press **vol/▲** or **vol/▼** to move the pointer to **Mute** and then press **☑/select**.

Mute On and  appear in the display. To cancel muting, repeat above step again. **Mute Off** appears for 2 seconds and  disappears from the display.

Tone Dialing Switch-over

Some telephone companies use equipment that requires pulse dialing (sometimes referred to as rotary dialing). If you need to enter tone dialing digits, you can switch-over to tone dialing during the call. This feature is useful when you need tone dialing to use automated systems, for example, entering your bank account number after you have called your bank.

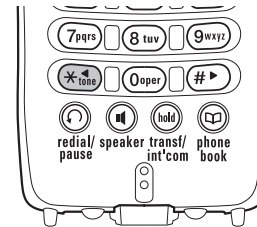

BASICS

Initially make your call with the pulse dialing mode. Once your call connects, press ***/tone/◀**. Enter the desired number. These digits will be sent as tone dialing. Once the call ends, the tone mode is canceled and pulse dialing mode resumes.

Notes:

- The tone feature only applies when the dial mode is set to pulse.
- This special number can be stored in a memory location. This is referred to as Chain Dialing (see page E56).

Traveling Out-of-Range

During a call, as you begin to move your handset too far from your base unit, noise may increase. If you pass the range limits of the base unit, you will hear a beep and see **Out of Range** on the display, and then the handset returns to standby mode. You may return to the call if you move your handset within the range limits of the base and press **talk/flash** or **speaker** within 30 seconds.

[E42] Basics

BASICS

Clarity Booster

If you encounter interference while using your phone, you can manually improve the sound by setting the Clarity Booster to on. **This works only when the phone is in use.**

A screenshot of a mobile phone's display during a call. The text on the screen is arranged in two lines: the top line shows 'Talk' on the left, 'B' in the middle, and a speaker icon on the right; the bottom line shows 'Boost On'.

- 1) Press **del/menu** during a call (while phone is in use).
- 2) Press **vol/▲** or **vol/▼** to move the pointer to Clarity Boost, and then press **☒/select**.
Boost On and B appear in the display.
To turn Off the Clarity Booster, repeat above step again. Boost Off appears for 2 seconds.

Privacy Mode

Privacy Mode allows you privacy, and guarantee of no interruption from other registered handsets. **This works only when the phone is in use.**

- 1) Press **del/menu** during a call (while phone is in use).
- 2) Press **vol/▲** or **vol/▼** to move the pointer to Privacy Mode, and then press **☒/select**.
Privacy Mode On and  appear in the display.

A screenshot of a mobile phone's display during a call. The text on the screen is arranged in two lines: the top line shows 'Talk' on the left, a phone icon in the middle, and a speaker icon on the right; the bottom line shows 'Privacy Mode On'.

BASICS

To exit the Privacy Mode, repeat above step again when the Privacy Mode is on.
Privacy Mode Off appears.

Find Handset

To locate the handset, press ***find handset*** on the base when the base is in standby mode. All registered handsets will beep for 60 seconds, and "Paging" appears on the handset display. To cancel paging, press any key on the handset or ***find handset*** on the base.

Note:

If the battery pack is completely drained, the handset will not beep when paging.

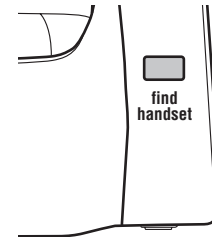

BASICS

Flash and Call Waiting

If you have Call Waiting service and a call waiting tone sounds while you are on a call, press **talk/flash** to accept the waiting call. There is a short pause, and then you will hear the new caller. To return to the original caller, press **talk/flash** again.

Note:

You must subscribe through your local telephone company to receive Call Waiting or Caller ID on Call Waiting service.

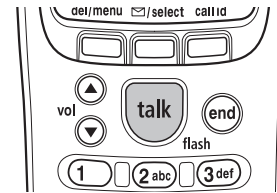

BASICS

Using One Touch Voice Mail Access

If you subscribe to voice mail service, you can use your phone to access your voice mailbox. The new message LED flashes whenever you have messages waiting in your voice mailbox. Just program the handset with your access number, and you can retrieve your messages at the touch of a button on the handset. (The voice mail service provider will supply you with the access number. This number may be simply a phone number. Refer to the provider's literature).

Note:

You must subscribe to voice mail service from your telephone company in order to use this feature. The voice mail service company will provide you with the access number.

•To program or delete your Voice Mail Access Number, See page E27.

Dialing your Voice Mail Service

Once you've programmed your personal access number, you can dial your mailbox with the touch of a button. When you have messages, simply pick up the handset and press /select. If you have not entered the access number or it has been deleted, No Number Stored To store number Press [MENU] appears and you will hear a beep. The phone returns to standby mode.

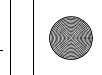
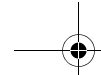
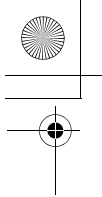

BASICS

Voice Mail Access

The new message LED on the handset is designed to work with your voice mail service provided by your local telephone company. The LED flashes when you have new incoming messages in the voice mail service. You may need to occasionally reset the indicators if they remain on after you've retrieved your messages. To reset the indicators, when the phone is in Standby Mode, press and hold ***find handset*** on the base until the paging sound stops (about 5 seconds).

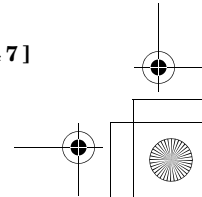
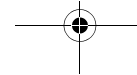
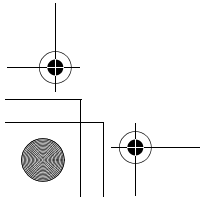
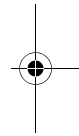
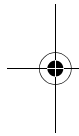

PHONEBOOK

Phonebook

The Phonebook allows you to dial a number using just a few key presses. Your phone stores names/numbers in the phonebook memory location, and you can search names in alphabetical order. You have a total of 100 locations that can be used for the phonebook (including the speed dials) and Caller ID messages.

Storing Phone Numbers, Names, Distinctive Rings, and Speed Dial

- 1) When the phone is in standby mode, press  **phonebook**.

The handset displays the following items:

(1st line) The number of the phonebook locations used

(2nd line) How to search (press the number keypad, **vol/▲** or **vol/▼**)

(3rd line) How to enter the storing operation (press the /**select** key)

```
Phonebook :100
Search [A-Z/↑/↓]
Store [SELECT]
```

[E48] Phonebook



PHONEBOOK

- 2) Press /select, Store/Edit Name appears.

```
Store/Edit Name
Movies
```

Note:

When the memory is full, you will hear a beep and MEMORY Full appears. You cannot store names and numbers.

- 3) Enter the name (up to 16 characters) by using the number keypad (see the "Steps for Entering Names and Special Characters" on page E51).
If a name is not required, go to step 4. <No Name> will be used as the name.
- 4) Press /select to store the name, Store/Edit No. appears.
- 5) Press the number keypad to enter the phone number (up to 20 digits), press /select to store the number.

```
Store/Edit No.
8007303456
```

Note:

The pause key counts as one digit. Pressing  redial/pause more than once increases the length of the pause between numbers. Each pause represents a 2 second delay.

PHONEBOOK

- 6) Distinctive Ring appears. Press **vol/▲** or **vol/▼** to move the pointer to one of the Distinctive Ring options, and then press **☐/select**.

```
Distinctive Ring
▶No Selectn
Flicker
```

Note:

If you choose not to store a Distinctive Ring, simply select the "No Selectn" option.

- 7) Speed Dial appears. Press **vol/▲** or **vol/▼** to move the pointer to select the Speed dial location (10 locations: SPD1-SPD0).

```
Speed Dial
▶No Selectn
SPD1:<Empty>
```

Notes:

- Selecting a speed dial location where a number is already stored releases the old number's speed dial setting. The new number will be stored in the speed dial location.
- If you choose not to store the name/number as a Speed Dial, simply select the "No Selectn" option.

- 8) Press **☐/select**. You will hear a confirmation tone, and **Done!** appears in the display.

```
Movies
800-730-3456
▶Beethoven9/SPD1
```

[E50] Phonebook

PHONEBOOK

Steps for Entering Names and Special Characters

Refer to the letters on the number keys to select the desired characters. With each press of a number key (0-9), the displayed character appears in the following order: upper case letters first, lower case letters next and finally the number corresponding to the key.

keys	Number of times key is pressed								
	1	2	3	4	5	6	7	8	9
1	i								
2 abc	A	B	C	a	b	c	2		
3 def	D	E	F	d	e	f	3		
4 ghi	G	H	I	g	h	i	4		
5 jkl	J	K	L	j	k	l	5		
6 mno	M	N	O	m	n	o	6		
7 pqrs	P	Q	R	S	P	r	s	7	
8 tuv	T	U	V	t	u	v	8		
9 wxyz	W	X	Y	Z	w	x	y	z	9
0 oper	&	<	>	<	>	/	(blank)	-	_
	.	,	#	?	!	@	'	"	*
	#	0							

Note:

If the next character uses the same number key, you must press #/▶ to move the cursor over. Otherwise the next time you press the number key, it changes the character that was previously set.

PHONEBOOK

If you make a mistake while entering a name

Use ***/tone/◀** or ***/▶** to move the cursor to the incorrect character.
Press **del/menu** to erase the wrong character and then enter the correct character.
To delete all characters, press and hold **del/menu**.

For example, to enter **Movies**:

- 1) When the phone is in standby mode, press **☰ phonebook**.
- 2) Press **☑/select**, **Store/Edit Name** appears.
- 3) Press **6** once, and then press ***/▶** to move the cursor to the right.
- 4) Press **6** six times.
- 5) Press **8** six times.
- 6) Press **4** six times.
- 7) Press **3** five times.
- 8) Press **7** eight times.
- 9) When finished, press **☑/select**.

To continue to store the telephone number, proceed to step 5 on page E49.

[E52] Phonebook

PHONEBOOK

Viewing the Phonebook

Your phone stores names/numbers in the phonebook memory locations, and you can search names in alphabetical order. You can view the phonebook even while the phone is in use.

- 1) Press  **phonebook**.

If you recall the phonebook during a call, Store [SELECT] will not appear.

```
Phonebook :100
Search [A-Z/↑/↓]
Store [SELECT]
```

- 2) Press **vol/▲**, **vol/▼**, or the number keypad to scroll through the phonebook locations. Phonebook locations appear in alphabetical order (from first to last when you press **vol/▼**, from last to first when you press **vol/▲**).

You can also use letters on the number keys to select the first letter of the desired name. Press a number key (**2-9** and **0**) once for the first letter, press twice for the second letter, and so on. The first location that begins with the letter you entered appears.

For example, to search for "Movies," press **6** once. Press **vol/▲** or **vol/▼**, until the phonebook location is displayed.

Phonebook [E53]

PHONEBOOK

- 3) To finish the viewing operation, press **end** (or **phonebook** during a call).

Note:

During a call, don't press **end** or the call will be disconnected.

Making Calls Using the Phonebook

From Standby Mode

- 1) When the phone is in standby mode, view the phonebook location to dial (see "Viewing the Phonebook" on page E53).
- 2) Press **talk/flash** or **speaker**. The displayed number is dialed.
- 3) To hang up press **end**.

```
Movies
800-730-3456
♪Beethoven9/SPD1
```

From Talk Mode

- 1) Press **talk/flash** or **speaker**.
- 2) View the phonebook location to dial (see "Viewing the Phonebook" on page E53).
- 3) Press **select**. The number in the displayed phonebook location is dialed.
- 4) To hang up press **end**.

[E54] Phonebook

PHONEBOOK

Speed Dialing

If you store a phone number in a speed dial memory location (10 locations: SPD1 - SPD0), you can use the speed dialing feature. When the phone is in standby mode, press and hold a number key (0-9) associated with the speed dial until the phone number appears, then press *talk/flash* or *speaker*. The number stored in speed dial (SPD1 - SPD0) is dialed.

Editing or Erasing a Stored Name, Phone Number, Distinctive Ring, and Speed Dial

- 1) When the phone is in standby mode, press  *phonebook*.
- 2) Press *vol/▲* or *vol/▼*, or the number keypad to view the phonebook locations (see "Viewing the Phonebook" on page E53).

```
Phonebook :100
Search [A-Z/↑/↓]
Store [SELECT]
```

a. Editing the Stored Data

- 1) When the phonebook location to be edited appears, press  */select*. Store/Edit Name appears.
- 2) Follow the steps 3 to 7 under "Storing Phone Numbers, Names, Distinctive Rings, and Speed Dial" on page E48 to complete the editing operation.

```
Store/Edit Name
Movie
```

Phonebook [E55]

PHONEBOOK

3) Press /select. You will hear a confirmation tone.

b. Deleting the Stored Data

1) When the phonebook location to be deleted appears, press **del/menu**.

Delete Memory? appears.

2) Press **vol/▲** to move the pointer to Yes.

3) Press /select. You hear a confirmation tone.

Deleted! appears for 2 seconds in the display.

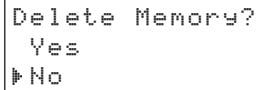

```
Delete Memory?  
Yes  
▶ No
```

Chain Dialing

The memory locations in the handset are not limited to phone numbers. You can also store a group of numbers (up to 20 digits), that you need to enter once your call connects. This is referred to as Chain Dialing.

An example of this is a bank account number. Store the account or special number in one of the phonebook locations. (Refer to "Storing Phone Numbers, Names, Distinctive Rings and Speed Dial" on page E48.) When you call your bank and you are prompted to enter the account number, scroll through your phonebook locations until you find your account number, and then press /select.

[E56] Phonebook

CALLER ID

Caller ID and CIDCW (Caller ID on Call Waiting)

You must subscribe to Caller ID services through your local telephone provider to use these features.

When the telephone rings, the Caller ID feature allows you to view the caller's name, and phone number along with the date and time of call. With CIDCW (Caller ID on Call Waiting), you will hear a call waiting tone while you are on a call, and the Caller ID data is displayed. To accept the waiting call, press **talk/flash** (see page E45). Additionally, you can dial a number stored in the Caller ID list or save data to your Phonebook locations.

Important:

Memory locations for Caller ID messages and Phonebook locations (including Speed Dials) are common, you can store up to 100 in total. A Caller ID message is not stored when you have stored 100 of the phonebook locations. The earliest Caller ID message is overwritten when you have stored 100 of the phonebook locations and Caller ID messages in total.

The date and time received	10/12 11:20AM
Caller's name	Jane Smith
Caller's phone number	214-555-1234

Caller ID [E57]

CALLER ID

- 1) When the Caller ID message is received, the display shows the caller's phone number along with the date and time. The incoming call information is stored in the Caller ID record. If the Caller ID service includes the caller's name, the name will appear in the display (up to 15 characters).

You may receive any one of the following messages:

When invalid data is received	Incomplete Data
When a private name is received	Private Name
When a private number is received	Private Number
When a unknown name is received	Unknown Name
When a unknown number is received	Unknown Number

- 2) When you pick up the phone, the display changes to Talk.
(Automatic Talk feature is set to on).

Notes:

- Data errors appear as "■."
- If you answer a call before the Caller ID message is received (for example, before the second ring), the Caller ID message will not appear.
- When the call is received via a telephone company that does not offer Caller ID service, the caller's phone number and name does not appear. (This includes some international calls.)
- When the call is via a private branch exchange (PBX), the caller's phone number and name may not appear.

[E58] Caller ID

CALLER ID

Viewing the Caller ID List

The Caller ID list stores information for incoming calls - even unanswered calls. You can store 100 of the Caller ID messages and Phonebook locations (including SpeedDials) in total. You can view the Caller ID list during a call or when the phone is in standby mode.

1) Press **call id**.

The summary screen appears. The screen shows the number of new messages and total messages.

2) To view the Caller ID messages in historical order (from new to old or from old to new), repeatedly press **vol/▼** to scroll through the messages from the latest to the earliest, or **vol/▲** to scroll back through the messages.

To view the Caller ID messages with alphabetical search, press the number key pad (**2-9** and **0**) with the letter associated with the first letter of the desired message.

Note:

Once you view the Caller ID list with alphabetical search, you cannot switch back to historical order (from new to old or from old to new) unless you exit and re-enter the operation.

CALLER ID

3) To finish the viewing operation, press **end** (or **call/id** during a call).

Notes:

- The number of calls from the same Caller ID appears next to the received time. Once you view the new message, the number will be cleared and disappear.
- During a call, don't press **end** or the call will be disconnected.

Deleting a Caller ID Message

Deleting Information from the Caller ID List

1) When the phone is in standby mode, view the Caller ID information to be deleted (see "Viewing the Caller ID List" on page E59).

```
Delete Caller ID
▶ Yes
  No
```

Note:

Once the Caller ID data has been deleted, the information cannot be retrieved.

- 2) Press **del/menu**. Delete Caller ID appears.
- 3) Press **vol/▲** or **vol/▼** to choose **Yes**.
- 4) Press **☑/select**. You will hear a confirmation tone.

[E60] Caller ID

CALLER ID

Deleting all Caller ID names/numbers

- 1) When the phone is in standby mode, press *call id*.
- 2) Press *del/menu*. Delete All? appears.
- 3) Press *vol/▲* or *vol/▼* to choose Yes.
- 4) Press *☐/select*. You will hear a confirmation tone.

```
Caller ID
New : 5
Total: 25
```

```
Delete All?
Yes
▶ No
```

Using the Caller ID Message List

Calling a party from the Caller ID list From Standby mode

- 1) When the phone is in standby mode, view the Caller ID message (see "Viewing the Caller ID List" on page E59).
- 2) Press *talk/flash* or *speaker*. The displayed phone number dials automatically.

```
10/12 11:20AM
Jane Smith
214-555-1234
```

Caller ID [E61]

CALLER ID



From Talk mode

- 1) Press *talk/flash* or *speaker*.
- 2) View the Caller ID message you want to dial (see "Viewing the Caller ID List" on page E59).
- 3) Press /*select*. The displayed phone number will be dialed.

Note:

You cannot make a call from the Caller ID list if your phone is connected to a private branch exchange (PBX).

Long Distance calls and Area Code Setting/Cancellation

While the present Caller ID information is displayed, pressing **/tone/* will place or remove the prefix "1" in the display to set the call for a long distance call, or pressing *#/* will set or cancel an area code (see page E31).

Note:

When a long distance call has been set, 1 appears in the display.

[E62] Caller ID

CALLER ID

Storing Caller ID messages in the Phonebook

Messages shown in the Caller ID list can be stored in the phonebook. The phone number and name of the party on the Caller ID list can be stored in memory.

Notes:

- If a call comes in via a telephone system that does not offer Caller ID service, no information is stored.
- If the Caller ID message was received as a private/unknown number, or the message does not have the number, you cannot store the message in the Phonebook. If it was received as private/unknown name, the message will be stored as <No Name>.
- Even if the 100 memory locations are full, the message will be stored in the Phonebook. However, the message will be erased from the Caller ID list.

- 1) When the phone is in standby mode, view the Caller ID message to be stored. Then press /**select**. *Store/Edit Name* appears.
- 2) To complete the setting, follow the steps 3-8 in "Storing Phone Numbers, Names, Distinctive Rings, and Speed dial" on page E49-E50.

CALLER ID

Call Waiting Deluxe Features

Your phone gives you new options for call waiting. At the touch of a button, you can place the caller on hold, send them to your voice mail service or conference them into your current call. You may be required to subscribe to Call Waiting and Call Waiting Deluxe to use these features. Not all features are available in all areas. Check with your local telephone company for details.

Notes:

- To activate features, select **CW On/CWDX On** in the CIDCW option. See page E31.
- You can also answer a waiting call immediately by pressing **talk/flash**, the first caller will be placed on hold. To return to the original caller, press **talk/flash** again.
- If you don't press a key within 30 seconds while in the operation, the phone goes back to the original call.

- 1) When you receive a Call Waiting call, press **del/menu** for a list of options.
- 2) Press **vol/▲** or **vol/▼** to select **CW Deluxe**, and then press **☑/select**.
- 3) Press **vol/▲** or **vol/▼** or the number keypad (**1-7**) to select an option.

[E64] Caller ID

CALLER ID

For example:
press **vol/▼** 4 times press **vol/▼** 2 times

1▶Ask to Hold	3 Forward Call	5 Conference
2 Tell Busy	4 Answer/Drop 1	6 Drop First
3 Forward Call	5▶Conference	7▶Drop Last

4) Press **☒/select**. A confirmation screen will appear, and returns back to the call.

Your phone is pre-programmed with seven call waiting options. You may select to ask the calling party to hold, send them a busy message, forward them to your voice mail, or answer and drop the first caller. You may also select to conference them into the current call or, at any time, choose to drop the first or drop the last caller. Check with your local telephone company for a full list of options.

Caller ID [E65]

EXPANDING YOUR PHONE

Expanding Your Phone

4 Multi-Handset Expandability

Your phone supports up to 4 handsets (including the handset(s) supplied with your phone). You can now place a fully-featured cordless handset anywhere AC power is available to connect the handset charger.

Up to 2 handsets can be used for an outside and/or intercom call.

For example, the phone permits 3-way conferencing (2 handsets and an outside line).

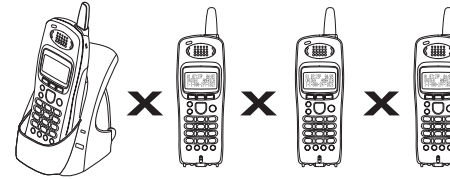

Important:

- If you purchase a CLT-0HE30 extra handset, please register the handset to the original/main base before use. The CLT-0HE30 will not operate until it is registered.
- Save this manual for detailed operation.
- All of the handsets ring when a call is received.
- If you change a Global setting in one handset, you change that particular setting for all registered handsets. All other settings (not included under Global Setup), must be set separately through each handset.

[E66] Expanding your phone

EXPANDING YOUR PHONE

Connecting the Charger

- 1) Connect the AC adapter to the **DC IN 9V** jack and to a standard 120V AC wall outlet.
- 2) Set the charger on a desk or tabletop, and place the handset in the charger with the keypad facing forward. (See "B. Install the rechargeable battery pack into the handset" on page E10).

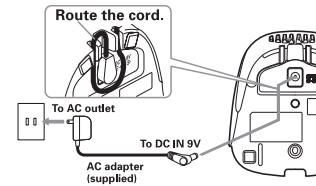

Note:

Charge the handset battery pack for at least 15-20 hours before using your new cordless telephone for the first time.

EXPANDING YOUR PHONE

Register the Handset to the Base

If you purchase a CLT-OHE30 extra handset, you need to register the handset to the base before use. Only one handset can be registered at a time.

Note:

An extra handset can be registered when the main base is in standby mode.

The handset ID for the supplied handset(s) was assigned at the factory, which has #1 or #2 in the display (#2 for models that have two handsets in packaging). When you register additional handset to the base, the handset ID will be assigned.

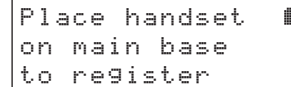

Place handset
on main base
to register

[E68] Expanding your phone

EXPANDING YOUR PHONE

- 1) Before registering the extra handset, the battery pack must be charged for 15-20 hours.
- 2) Place the extra handset in the main base unit to begin registration.
- 3) While the handset is registering, *Handset Registering* will appear in the LCD. When *Registration Complete* is displayed, the handset has been registered to the base. If *Registration Failed* appears, please try these steps again.

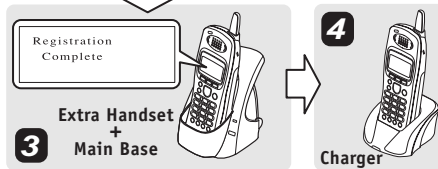

Expanding your phone [E69]

EXPANDING YOUR PHONE

Using the Walkie-Talkie (Direct-Link) Mode (For Multi Handsets)

To use this feature, you must enter the two handsets into the Walkie-Talkie mode first.

Notes:

- Two handsets can be in Walkie-Talkie mode while other handsets are in use.
- While a handset is in Walkie-Talkie mode, it can't be used to make or receive a call. Other handsets can still make or receive a call.

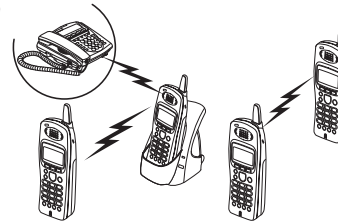

To enter the Walkie-Talkie mode, see page E25.

Walkie-Talkie Call

- 1) When the phone is in the Walkie-Talkie standby mode, press **talk/flash** (example of Walkie-Talkie call from handset #1).
- 2) Select the handset to which you wish to make a Walkie-Talkie call with by pressing the number keys (1-4). Your handset will then page the other handset.

```
SUN 12:00A  ■■  
Handset #1  
DirectLink Mode
```

```
To DirectLink  ■■  
a handset  
press [1-4]
```

[E70] Expanding your phone

EXPANDING YOUR PHONE

- 3) On the receiving handset, press **talk/flash**, or if Any Key Answer is on, press any number key, ***/tone/◀**, or **#/▶**.
- 4) When you finish your conversation, press **end** on either handset. Return the handset to the cradle, or press **del/menu**, and then **☐/select** to return to normal standby mode (canceling Walkie-Talkie mode).

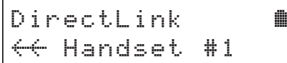

DirectLink
<< Handset #1

Room Monitor (For Multi Handsets)

This feature allows you to monitor sounds in another room. To use this feature, place the handset in the desired room to monitor (act an remote mic), and place the other near listener (remote speaker). For instruction, see "Using Room Monitor" on page E26.

EXPANDING YOUR PHONE

3-Way Conferencing (For Multi Handsets)

The phone permits 3-way conversations between 2 handsets, and an outside line.

- 1) During a call, press **talk/flash** on another handset to initiate the 3-way conversation.
- 2) To remove either caller from your conversation, press **end** key on either handset.

The other handset will still be connected to the call.

Note:

If the other handset is in Privacy mode, you won't be able to join the call.

Intercom/Call Transfer Feature (For Multi Handsets)

If you have more than one handset, you can enjoy an intercom call between handsets. Also, you can place an outside call on hold and transfer the call to another handset.

Notes:

- If the party is busy or out of range, the handset returns to standby mode.
- If any of the following occurs while selecting the other handset, the operation will be canceled.
 - Press **talk/flash** or **speaker**.
 - Receive an outside/intercom call or page.
- When the party does not answer within one minute, the operation is canceled.
- During an intercom call, if you receive a call, you will hear a ringer tone from the earpiece.

[E72] Expanding your phone

EXPANDING YOUR PHONE

Intercom

- 1) Press **hold/transf/int'com** in standby mode.
- 2) Select the handset you want to talk with from the selection list within 30 seconds. To select the handset, press **vol/▲** or **vol/▼** and then press **☐/select**.
If you select **All**, all handsets will be paged.
An intercom tone sounds.

```
To intercom
▶Handset #2
Handset #3
```

- 3) On the receiving handset, to answer the call, press **talk/flash** or **hold/transf/int'com**.
If you turn Automatic Talk on, pick up the handset from the cradle. If Anykey Answer is on, press any number key, ***/tone/◀** or **#/▶**.
- 4) To finish the intercom call, press **end** on either handset.

Note:

If the handset you're trying to page is busy, the phone displays unavailable.

EXPANDING YOUR PHONE

Call Transfer Feature

1) During a call, press **hold/transf/int'com**.

2) Select a handset to transfer the call within 10 seconds.
(Refer to step 2 in the intercom section on page E73).
The call will automatically be placed on hold, and an intercom tone sounds.

```
Hold, to transfer
▶ Handset #2
  Handset #3
```

To cancel the transfer, press **talk/flash** or **speaker** on the initiating handset.

3) On the receiving handset, to answer the page, press **talk/flash** or **hold/transf/int'com**.
If you turn Automatic Talk on, pick up the handset from the cradle. If Anykey Answer is On, press any number key, ***/tone/◀**, or **#/▶**. The intercom mode is activated, but the caller is still on hold.

4) To accept the transfer and talk to the outside caller, press **talk/flash** on the receiving handset.

Replacing the Base

If the base unit is replaced with a different base from the same series of cordless models, you must clear the handset (s) and base identification numbers. To do this, select "System Reset" from handsets display menu option list (see page E34 for guidance).

[E74] Expanding your phone

ADDITIONAL INFORMATION

Changing the Digital Security Code

The digital security code is an identification code used to connect the handset and the base unit. Normally, setting the code is not necessary. In rare situations that you suspect another cordless telephone is using the same security code, you can change the code.

To change the digital security code:

1. Perform the "System Reset" menu options ("De-register the Handset" and "Replacing the Base Setting") for all the handsets you have (see page E34).

2. To register all the handsets do the following steps:

1) Place a handset in the base at a time.

2) Registration starts automatically.

Handset Registering appears in the display.

3) When Registration Complete appears in the display, the handset is registered to the base.

4) Repeat steps 1 - 3 for other handsets.

If Registration Failed appears in the display, try the steps above again.

ADDITIONAL INFORMATION

Installing the Beltclip

To attach the beltclip

Insert the beltclip into the holes on each side of the handset.
Press down until it clicks.

To remove the beltclip

Pull either side of the beltclip to release the tabs from the holes.

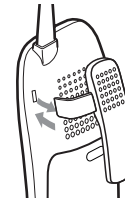

Headset Installation

Your phone may be used with an optional headset. To use this feature, insert the headset plug into the headset jack. Your phone is ready for hands-free conversations.



[E76] Additional Information

ADDITIONAL INFORMATION

Note on power sources

Battery replacement and handling

When the operating time becomes short even after a battery is recharged, please replace the battery.

With normal usage, your battery should last about one year.

Warning: To avoid the risk of personal injury or property damage from fire or electrical shock, only use the Sanyo battery model and Sanyo adapter model specifically designated for this product.

RECYCLING Nickel-Metal-Hydride BATTERIES

Nickel-Metal-Hydride BATTERIES MUST BE DISPOSED OF PROPERLY.



Nickel-Metal-Hydride cells are used in the battery pack. Please take your used battery packs to a store that recycles Nickel-Metal-Hydride batteries.

Power Failure

During the period that the power is off, you will not be able to make or receive calls with the telephone.

ADDITIONAL INFORMATION

Caution

- Use only the specified Sanyo battery pack.
- Do not remove the battery from each handset to charge it.
- Never throw the battery into a fire, disassemble it, or heat it.
- Do not remove or damage the battery casing.

Troubleshooting

If your phone is not performing to your expectations, please try these simple steps first.

Symptom	Suggestion
The charge LED won't illuminate when the handset is placed in the cradle.	<ul style="list-style-type: none">• Make sure the AC adapter is plugged into the base (or the charger (for multi-handset packs)) and wall outlet.• Make sure the handset is properly seated in the cradle.• Make sure the charging contacts on the handset and the base (or the charger (for multi-handset packs)) are clean.
The audio sounds weak.	<ul style="list-style-type: none">• Move the handset and/or base to a different location away from scratchy metal objects or appliances and try again.• Make sure that you are not too far from the base.

[E78] Additional Information

ADDITIONAL INFORMATION

Symptom	Suggestion
Can't make or receive calls.	<ul style="list-style-type: none"> • Check both ends of the telephone cord. • Make sure the AC adapter is plugged into the base and wall outlet. • Disconnect the AC adapter for a few minutes, and then reconnect it. • Remove the base ID (see "Replacing the Base Setting" on page E34) and register the handset (see "Register the Handset to the Base" on page E68). • Make sure that you are not too far from the base. • If an outside call is already established, you can not make another outside call.
The handset doesn't ring or receive a page.	<ul style="list-style-type: none"> • Place the handset on the base or charging cradle and charge the batteries in the handset for 15-20 hours. • The handset may be too far away from the base unit. • Place the base unit away from appliances or metal objects. • Remove the base ID (see "Replacing the Base Setting" on page E34) and register the handset (see "Register the Handset to the Base" on page E68).
Unavailable appears in the display.	<ul style="list-style-type: none"> • Make sure another handset(s) or base is not in use, and try the phone again. • Make sure that you are not too far from the base.
Severe noise interference.	<ul style="list-style-type: none"> • Keep the handset away from microwave ovens, computers, remote control toys, wireless microphones, alarm systems, intercoms, room monitors, fluorescent lights, and electrical appliances. • Move to another location or turn off the source of interference.

Additional Information [E79]

ADDITIONAL INFORMATION

Symptom	Suggestion
The Caller ID does not display.	<ul style="list-style-type: none"> • The handset was picked up before the second ring. • The call was placed through a switchboard. • Call your local telephone company to verify your Caller ID service is current.
Voice Message Indication does not work.	<ul style="list-style-type: none"> • Contact your local telephone company to make sure that your telephone receives FSK or SDT message signaling.
You cannot register the handset at the base.	<ul style="list-style-type: none"> • Charge the battery pack for 15-20 hours. • Remove the base ID (see "Replacing the Base Setting" on page E34) and register the handset (see "Register the Handset to the Base" on page E68).
The handset doesn't communicate with the other handsets.	<ul style="list-style-type: none"> • Remove the base ID (see "Replacing the Base Setting" on page E34) and register the handset (see "Register the Handset to the Base" on page E68). • Make sure that you have registered all handsets.
An extra handset can't join the conversation.	<ul style="list-style-type: none"> • There are 2 handsets already using the 3-way conference feature.
You cannot make an intercom call with another handset.	<ul style="list-style-type: none"> • Make sure that the receiving handset is not in use.

[E80] Additional Information

ADDITIONAL INFORMATION

Technical Information

IMPORTANT SAFETY INSTRUCTIONS

When using your telephone equipment, basic safety precautions should always be followed to reduce the risk of fire, electric shock and injury to persons, including the following:

- 1 Do not use this product near water, for example, near a bath tub, wash bowl, kitchen sink or laundry tub, in a wet basement or near a swimming pool.
- 2 Avoid using a telephone (other than a cordless type) during an electrical storm. There may be a remote risk of electric shock from lightning.
- 3 Do not use the telephone to report a gas leak in the vicinity of the leak.
- 4 Use only the power cord and batteries indicated in this manual. Do not dispose of batteries in a fire. They may explode. Check with local codes for possible special disposal instructions.

SAVE THESE INSTRUCTIONS

Caution: Risk of explosion if battery is replaced by an incorrect type. Dispose of used batteries according to the instructions.

Additional Information [E81]

ADDITIONAL INFORMATION

I.C. Notice TERMINAL EQUIPMENT

NOTICE:

This equipment meets the applicable Industry Canada Terminal Equipment Technical Specifications. This is confirmed by the registration number. The abbreviation, IC, before the registration number signifies that registration was performed based on a Declaration of Conformity indicating that Industry Canada technical specifications were met. It does not imply that Industry Canada approved the equipment.

NOTICE:

The Ringer Equivalence Number (REN) for this terminal equipment is marked on the equipment itself. The REN assigned to each terminal equipment provides an indication of the maximum number of terminals allowed to be connected to a telephone interface. The termination on an interface may consist of any combination of devices subject only to the requirement that the sum of the Ringer Equivalence Numbers of all the devices does not exceed five.

RADIO EQUIPMENT

The term "IC:" before the radio certification number only signifies that Industry Canada technical specifications were met. Operation is subject to the following two conditions: (1) this device may not cause interference, and (2) this device must accept any interference, including interference that may cause undesired operation of the device. "Privacy of communications may not be ensured when using this telephone".

[E82] Additional Information

THE SANYO COMFORT WARRANTY

WARRANTY APPLICATION

Sanyo Communications products purchased new, unused in Canada through a Sanyo Authorized Dealer are warranted against manufacturing defects in materials and workmanship for **ONE YEAR** covering parts and labour, from the date of purchase by the original retail purchaser. This warranty only applies in favour of the original retail purchaser of the warranted product.

SANYO CANADA INC.'S RESPONSIBILITY

During the warranty period, SANYO Canada Inc. will repair, or at our option, replace a Communications product which shows evidence of a manufacturing defect in materials or workmanship. Replacement PARTS are warranted for the remaining portion of the warranty period.

WHAT IS NOT COVERED

- (a) Communications products purchased outside Canada.
- (b) Communications products purchased in a used condition.
- (c) Communications products purchased from non-authorized SANYO dealer.
- (d) Communications products not intended for Canadian usage or products without appropriate Canadian regulatory approvals.
- (e) Problems due to product set-up and installation.
- (f) Adjustments that are outlined in the Operating Manual.
- (g) Accessory items including antenna, and batteries,
- (h) Damage in or due to transportation.
- (i) Damage due to improper maintenance, accident, abuse, misuse or negligence.
- (j) Damage caused by lightning and power surges.

Additional Information [E83]

THE SANYO COMFORT WARRANTY

ORIGINAL RETAIL

PURCHASER'S RESPONSIBILITY

You, the original retail purchaser, must present your original, dated bill-of-sale together with this warranty to SANYO Canada Inc. or to an authorized Sanyo Service Depot when you make a claim under this warranty.

You, the original retail purchaser, are responsible for any costs of TRANSPORTING the product to and from SANYO Canada Inc. or an authorized Sanyo Service Depot. You also are responsible for the cost of any MAINTENANCE necessary in respect of the product.

WARRANTY BECOMES VOID

This warranty becomes void if the product's serial numbers are altered or removed or if any repair to the product is made other than by SANYO Canada Inc. or by an authorized Sanyo Service Depot.

LIMITATIONS

(a).SANYO Canada Inc. reserves the right to change or improve the design of the model of the product warranted hereunder without incurring any obligation to make any modifications to or to install any

improvement in or on the product.
(b).In no event shall SANYO Canada Inc. or any of its Authorized Dealers be liable for special or consequential damage arising from the use of this product.

STATUTORY WARRANTIES

The above provisions do not preclude the operation of any applicable provincial statute which in certain circumstances may not allow some of the limitations and exclusions described in this Warranty. Where any terms of this Warranty are prohibited by such a statute, they shall be deemed null and void but the remainder of this warranty shall remain in effect.

HOW TO OBTAIN WARRANTY SERVICE

Please contact the Sanyo Authorized Dealer from whom the product was purchased, or contact us directly at:

SANYO Canada Inc.
1-300 Applewood Cres.
Concord, Ont. L4K 5C7
(905) 760-9944
1-800-263-2244

[E84] Additional Information

SOS HELP LINE

At Sanyo, fulfilling the needs of our customers is a priority. That's why we created our SOS customer service program that guarantees satisfaction.

NATIONWIDE CUSTOMER SUPPORT

SOS is there to help you. Our friendly and knowledgeable product specialists will quickly answer your questions about setup and use of Sanyo telephone products. Simply call toll free from anywhere in Canada to connect to our no-charge, SOS support and service network:

1-800-263-2244

between 8:30 am – 7:00 pm EST

Or visit our website at www.sanyoservice.com, and click the **Customer Relations** button to get access to our FAQ's (Frequently Asked Questions) and other helpful features.

STAY-AT-HOME CONVENIENCE

It's a nuisance making another trip to the store when you're stuck. Now with SOS, all that's necessary is a quick call from your home for product assistance.

HASSLE-FREE EXCHANGE

Should your Sanyo telephone require servicing due to a manufacturing defect during the warranty period, SANYO Canada will ship prepaid a replacement unit* within two business days after receiving your defective unit. **Consumers are responsible for the shipping costs of the unit back to Sanyo.**

- For older, non-current models, replacement units may not be available, in which case our regular warranty conditions will apply.

GUARANTEED QUALITY

All SOS replacement sets are checked and serviced by factory-authorized technicians before being sent out. SOS means you never have to worry. C.O.D. and/or Collect shipments will not be accepted. Unit must be returned to Sanyo in its original box with all accessories, i.e.: owner's manual, battery, adaptor, telephone cord, etc.

Additional Information [E85]

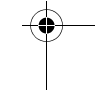
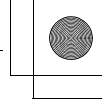
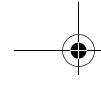
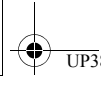
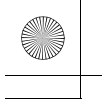

Covered under one or more of the following U.S. patents:

4,797,916	5,381,460	5,426,690	5,434,905	5,491,745	5,493,605
5,533,010	5,574,727	5,581,598	5,650,790	5,660,269	5,661,780
5,663,981	5,671,248	5,696,471	5,717,312	5,732,355	5,754,407
5,758,289	5,768,345	5,787,356	5,794,152	5,801,466	5,825,161
5,864,619	5,893,034	5,912,968	5,915,227	5,929,598	5,930,720
5,960,358	5,987,330	6,044,281	6,070,082	6,125,277	6,253,088
6,314,278	6,418,209	6,618,015	6,671,315	6,714,630	6,782,098
6,788,920	6,788,953				

All rights reserved

UPZZ01384AZ(0)

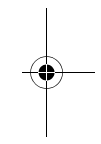
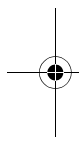

SANYO

SANYO Canada Inc.
Printed in China

