

Cat. No. 43-935
OWNER'S MANUAL

Please read before using this equipment.

Two-Line Caller ID Phone

With Speakerphone

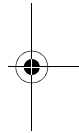
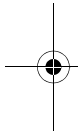

RadioShack®

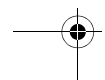
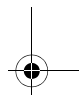
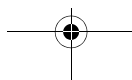
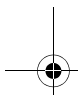

FEATURES

Your RadioShack Two-Line Caller ID Phone offers the latest in telephone technology, combining Caller ID features, two telephone lines, and speakerphone all in one easy-to-use telephone.

The system displays a caller's phone number (and name, if available in your area), the current date and time, and call information as provided by your local phone company to Caller ID and message waiting service subscribers.

Your phone includes these features:

Speakerphone — allows hands-free telephone conversation.

Caller ID Memory — stores and displays up to 99 incoming phone numbers, or up to 68 call records (incoming phone numbers plus names).

Last Number Redial — lets you quickly dial the last number dialed.

Flash — sends a switchhook signal for use with special phone services such as Call Waiting.

Handset Volume Control — lets you adjust the handset volume to be low, middle or high.

Large Liquid Crystal Display — displays four full lines of information, including the time, the number you dialed, and other useful information.

Two Telephone Lines — allows you to select which line you prefer.

Caller ID Memory Dial — lets you select a stored phone number from Caller ID memory, then dial it with the touch of a button.

Five Pre-stored Area Codes — allows you to edit, store, delete or review a maximum of five area codes. Each area code contains three digits.

Review — lets you scroll through all call records in Caller ID memory.

Call Back — lets you quickly dial the number shown on the display.

Delete — lets you delete one or all call records from memory.

20-Number Memory — lets you store and then quickly dial up to 20 important phone numbers by pressing a single button or two buttons.

Pulse/Tone Option — lets you use the system with pulse or tone service and lets you easily switch from pulse to tone dialing for long-distance, bank-by-phone, or other special services.

Line Status Indicators — alerts you to incoming calls and the status of a phone line using ringing tones, the display, and indicator lights.



Hearing-Aid Compatible — lets you use the system with hearing aids.

© 2000 Tandy Corporation.
All Rights Reserved.

RadioShack and Adaptaplug are registered trademarks used by Tandy Corporation.

Your phone is ETL listed to UL standards and meets all applicable FCC standards.

WARNING: To reduce the risk of fire or shock hazard, do not expose this product to rain or moisture.

	CAUTION RISK OF ELECTRIC SHOCK. DO NOT OPEN.	
CAUTION: TO REDUCE THE RISK OF ELECTRIC SHOCK, DO NOT REMOVE COVER OR BACK. NO USER-SERVICEABLE PARTS INSIDE. REFER SERVICING TO QUALIFIED PERSONNEL.		



This symbol is intended to alert you to the presence of uninsulated dangerous voltage within the product's enclosure that might be of sufficient magnitude to constitute a risk of electric shock. Do not open the product's case.



This symbol is intended to inform you that important operating and maintenance instructions are included in the literature accompanying this product.

Notes:

- Your system requires two AA batteries (not supplied) to protect its memory.
- The AC adapter must be connected with your system to operate properly. If no AC adapter is connected, only LINE1 operates.

Important Caller ID Information

To use the phone's Caller ID and Message Waiting features you must be in an area where those services are available and you must subscribe to those services through your local phone company.

Where Caller ID is offered, one or more options are generally available:

- caller's number only
- caller's name only
- caller's name and number.

READ THIS BEFORE INSTALLATION

We have designed your telephone to conform to federal regulations, and you can connect it to most telephone lines. However, each device that you connect to the phone line draws power from the phone line. We refer to this power draw as the device's ringer equivalence number, or REN. The REN is shown on the bottom of your phone.

If you are using more than one phone or other device on the line, add up all the RENs. If the total is more than five (or three in rural areas), your phones might not ring. If ringer operation is impaired, disconnect one of the devices from the line.

FCC STATEMENT

This telephone complies with Part 68 of FCC Rules. You must, upon request, provide the FCC Registration Number and the REN to your phone company. These numbers are located on the bottom of your phone.

Note: You must not connect your phone to any of the following:

- coin-operated systems
- party-line systems
- most electronic key telephone systems

The system complies with the limits for a Class B device as specified in Part 15 of FCC Rules. These limits provide reasonable protection against radio and TV interference in a residential area. However, your telephone might cause TV or radio interference even when it is operating properly. To eliminate interference, you can try one or more of the following corrective measures.

- Reorient or relocate the TV's receiving antenna.
- Increase the distance between the telephone and the radio or TV.

Consult your local RadioShack store if the problem still exists.

IMPORTANT SAFETY INSTRUCTIONS

SAVE THESE INSTRUCTIONS — To reduce the risk of fire, electric shock and/or injury, always follow these basic safety precautions when using your telephone equipment.

1. Read and understand all instructions.
2. Follow all warnings and instructions marked on the telephone.
3. Unplug this telephone from the wall outlet before cleaning it or replacing the batteries. Do not use liquid or aerosol cleaners. If necessary, use a soft cloth lightly moistened with a mild detergent solution.
4. Do not use this telephone near a bathtub, kitchen sink, wash bowl, laundry tub, swimming pool, a wet basement or anywhere else there is water.
5. Do not place this telephone on an unstable cart, stand or table. A fall could cause serious damage to the phone.
6. Slots and openings in the cabinet at the back or bottom are provided for ventilation to protect the unit from overheating. These openings must not be blocked or covered. Do not place this telephone on a bed, sofa, rug or other similar surface. This product should never be placed near or over a radiator or heat register. This telephone should not be placed in a built-in installation unless proper ventilation is provided.

7. Never push objects of any kind through slots in the phone. You could touch dangerous voltage points or short out parts that could result in a risk of fire or electric shock. Never spill liquid of any kind on the telephone.
8. Unplug this telephone from the wall outlet and refer to a qualified service representative in any of the following situations:
 - If liquid has been spilled into the telephone.
 - If the telephone has been exposed to rain or water.
 - If the telephone does not operate normally by following the operating instructions.
 - If the telephone has been dropped or the case has been damaged.
 - If the telephone exhibits a distinct change in performance.
9. Adjust only those controls that are covered by the operating instructions. Improper adjustment of other controls may result in damage and will often require extensive work by a qualified technician to restore the telephone to normal operation.
10. Avoid using a telephone (other than a cordless type) during an electrical storm. There may be a remote risk of electric shock from lightning.
11. Do not use the telephone to report a gas leak in the vicinity of the leak.
12. Never install telephone wiring during a lightning storm.
13. Never install jacks in a wet location unless the jack is specifically designed for wet locations.
14. Never touch uninsulated telephone wires or terminals unless the telephone line has been disconnected at the network interface.
15. Use caution when installing or modifying telephone lines. To reduce the risk of electric shock, do not disassemble this product, but take it to a qualified serviceman when service or repair work is required. Opening or removing covers may expose you to dangerous voltages or other risks. Incorrect reassembly can cause electric shock when the appliance is subsequently used.

BATTERY SAFETY INSTRUCTIONS

Caution: To reduce the risk of fire or injury to persons, read and follow these instructions.

1. Use only two carbon-zinc or alkaline AA size batteries.
2. Do not dispose of the batteries in a fire. The cell may explode. Check with local codes for possible special disposal instructions.
3. Do not open or mutilate the batteries. Released electrolyte is corrosive and may cause damage to the eyes or skin. It may be toxic if swallowed.

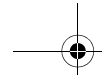

-
4. Exercise care in handling batteries in order not to short the battery with conducting materials such as rings, bracelets and keys. The battery or conductor may overheat and cause burns.
 5. Do not attempt to recharge the batteries provided with or identified for use with this product. The batteries may leak corrosive electrolyte or explode.
 6. Do not attempt to rejuvenate the batteries provided with or identified for use with this product by heating them. Sudden release of the battery electrolyte may occur causing burns irritation to eyes or skin.
 7. When replacing batteries, all batteries should be replaced at the same time. Mixing fresh and discharged batteries could increase internal cell pressure and rupture the discharged batteries.
 8. When inserting batteries into this product, the proper polarity or direction must be observed. Reverse insertion of batteries can cause charging, and that may result in leakage or explosion.
 9. Remove the batteries from this product if the product will not be used for a long period of time (several months or more) since during this time the battery could leak in the product.
 10. Discard dead batteries as soon as possible since dead batteries are more likely to leak in a product.
 11. Do not store this product, or the batteries provided with or identified for use with this product, in high-temperature areas. Batteries that are stored in a freezer or refrigerator for the purpose of extending shelf life should be protected from condensation during storage and defrosting. Batteries should be stabilized at room temperature prior to use after cold storage.

SAVE THESE INSTRUCTIONS

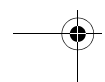
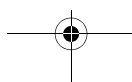
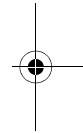
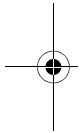

CONTENTS

Preparation	8
Installing Batteries	8
Selecting a Location	9
Mounting the System	9
Attaching the Stand	9
On a Desk Top	10
On a Wall Plate	10
On the Wall	10
Connecting the Handset	11
Connecting AC Power	11
Disabling the Line 2 Indicator	12
Adjusting the Display Contrast	12
Setting the Ringer Volume	12
Setting the Dialing Mode	12
Initializing the System	13
Operation	14
Making and Receiving Calls	14
Adjusting the Handset Volume	14
Using the Speakerphone	14
New Call Indicator	15
Using Mute	15
Using Flash	15
Using Redial	15
Using Hold	15
Identifying the Indicators	16
Ringer Indicators	16
Display and Light Indicators	16
Using Caller ID	17
Caller ID Display Information	17
Reviewing Call Records	18
Area Code	19
Dialing Numbers In Call Records	19
Deleting Call Records	20
Storing Call Records Into Memory Locations	20
Memory Dialing	20
Storing a Pause In Memory	20
Storing Numbers Into Memory	21
Storing Call Records Into Memory	21
Storing the Last Number Dialed Into Memory	22
Storing Special Service Numbers	22
Using the Quick Reference Card	22
Using the Memory Card	23
Reviewing Stored Numbers	23
Dialing Stored Numbers	23
Deleting Stored Numbers	23
Troubleshooting	24
Care and Maintenance	25
The FCC Wants You To Know	26
Lightning	26

PREPARATION

INSTALLING BATTERIES

Your phone requires two AA batteries (not supplied) for power. For the best performance and longest life, we recommend RadioShack alkaline batteries.

Note: The batteries protect the phone's memory during power failures. If you do not connect the supplied AC adapter, the batteries cannot power all the phone's functions. (See "Connecting AC Power" on Page 11.)

Cautions:

- Use only fresh batteries of the required size and recommended type.
- Do not mix old and new batteries, different types of batteries (standard, alkaline, or rechargeable), or rechargeable batteries of different capacities.

Follow these steps to install batteries.

1. Use a flat blade screwdriver to loosen the screw on the battery compartment cover on the bottom of the phone, and remove the cover.
2. Place the batteries in the compartment as indicated by the polarity symbols (+ and -) marked inside.
3. Replace the cover and secure it with the screw.

When  appears on the display or the display dims, replace the batteries.

Warning: Dispose of old batteries promptly and properly. Do not burn or bury them.

Caution: If you do not plan to use the the phone for a month or more, remove the batteries. Batteries can leak chemicals that can destroy electronic parts.

Notes:

- If you replace the batteries, have fresh batteries on hand before you begin. You must install fresh batteries within 1 minute after removing the old batteries. Otherwise, you might lose the information stored in the system.
- When you are replacing the batteries, do not press any buttons on the system after you remove the old batteries. Doing so might erase all stored information from the system.

SELECTING A LOCATION

You can place the phone on a desk top or table, or mount it on a standard wall plate. Select a location that is:

- near an accessible AC outlet
- near a telephone line jack
- out of the way of normal activities
- away from electrical machinery, electrical appliances, metal walls or filing cabinets, wireless intercoms, alarms, and room monitors

Note: The base's location affects the phone's range. If you have a choice of several locations, try each to see which provides the best performance.

MOUNTING THE SYSTEM

Attaching the Stand

To mount the phone on a wall or desk top, you need to attach the supplied stand to the phone.

To place the phone on a desk top, insert the tab on the narrow end of the stand into the upper center slot. Then snap the two spring tabs on the wide end of the stand into place.

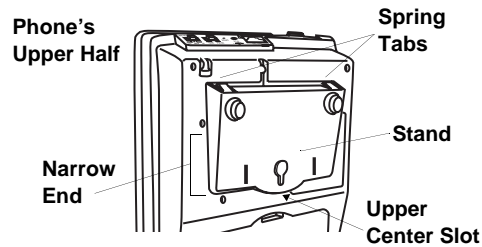

To mount the phone on a wall plate or directly on the wall, insert the tab on the narrow end of the stand into the lower center slot. Then snap the two spring tabs on the wide end of the stand into place.

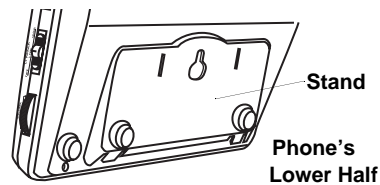

To remove the stand from the phone, while pressing and holding in both spring tabs, gently pull up the wide end of the stand and lift it off.

On a Desk Top

Follow these steps to mount the system on a desktop.

1. Plug one end of the supplied long modular cord into the **TEL LINE** jack on the back of the phone.
2. Plug the other end of the modular cord into a modular phone jack.
3. Place the phone on a flat desk, shelf, or table.

4. Align the base's keyhole slots with the wall plate studs and slide the base downward to secure it.

5. Press and lift out the handset holder. Rotate it 180°, then snap it back into place so it holds the handset.

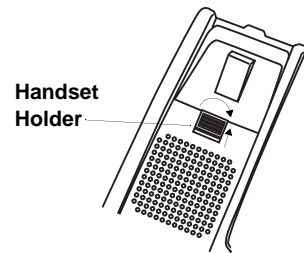

On a Wall Plate

Follow these steps to mount the system on a standard wall plate.

1. Plug one end of the supplied short modular cord into the **TEL LINE** jack on the back of the system. Then route the cord through the strain relief groove on the bottom of the phone.

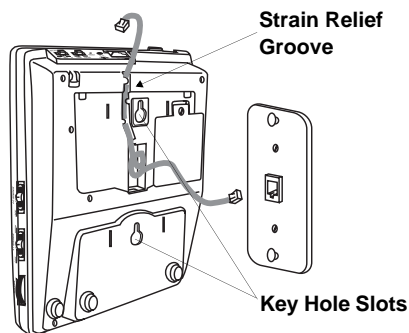

2. Feed any excess modular cord into the cavity at the base of the strain relief groove.
3. Plug the other end of the modular cord into the wall plate's modular jack.

On the Wall

To install the system directly on the wall, you need two screws (not supplied) with heads that fit into the keyhole slots on the bottom of the phone and the stand.

1. Drill two holes $3^{15}/16$ inches (100 mm) apart. Then thread a screw into each hole, letting the heads extend about $1/8$ inch (3.5 mm) from the wall.

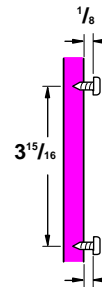

2. Plug one end of the supplied long modular cord into the **TEL LINE** jack on the back of the system.
3. Align the bracket's keyhole slots with the mounting screws and slide the base downward to secure it.
4. Plug the other end of the modular cord into a nearby modular jack.

5. Press and lift out the handset holder. Rotate it 180°, then snap it back into place so it holds the handset.

CONNECTING THE HANDSET

1. Plug one end of the supplied coiled cord into the handset's modular jack.
2. Plug the other end of the coiled cord into the handset jack on the side of the phone nearest the handset cradle.
3. Place the handset on the cradle.

Note: Your local RadioShack store carries several different lengths of coiled phone cords that are especially useful when wall mounting the phone.

CONNECTING AC POWER

You can power the phone using the supplied 9V, 300-mA AC adapter and a size K Adaptaplug® adaptor (available at your local RadioShack store).

Note: For the Caller ID function to work and to use LINE 2, you must connect the phone to AC power.

Cautions:



You must use a Class 2 power source that supplies 9V DC and delivers at least 300 mA. Its center tip must be set to negative and its plug must fit the phone's **DC 9V** jack. The supplied adapter meets these specifications. Using an adapter that does not meet these specifications could damage the phone or the adapter.

- Always connect the AC adapter to the phone before you connect it to AC power. When you finish, disconnect the adapter from AC power before you disconnect it from the phone.

Follow these steps to connect the AC adapter.

1. Insert the supplied AC adapter's barrel plug into the phone's **DC 9V** jack.
2. Route the AC adapter's cord through the strain relief slot.

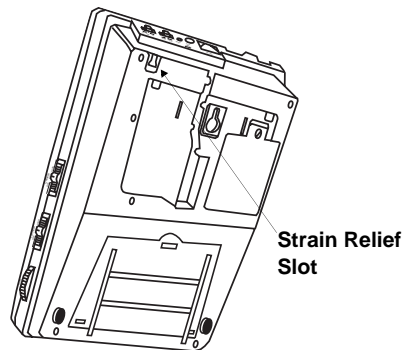

3. Plug the other end of the AC adapter into a standard AC outlet.

DISABLING THE LINE 2 INDICATOR

If you have only one telephone line, the LINE 2 indicator lights and **LINE 2 EXTENSION** appears on the display. Follow these steps to disable the LINE 2 indicator.

1. Press **REVIEW** ▲ or ▼ repeatedly until the call total appears.
2. Press **REVIEW** ▼ until **LINE 2 ENABLED** appears (about 3 seconds).
3. Press **REVIEW** ▲ or ▼. **LINE 2 DISABLED** appears.
4. Press **DELETE** to return to the current time display.

ADJUSTING THE DISPLAY CONTRAST

1. Press **REVIEW** ▲ or ▼ repeatedly until the call total appears.
2. Press and hold down **REVIEW** ▲ for about 3 seconds until **CONTRAST X** appears.
3. Within 30 seconds, repeatedly press **REVIEW** ▲ or ▼ to adjust the display's contrast from 1 to 8.

Notes:

- If **CONTRAST X** disappears before you press **REVIEW** ▲ or ▼, repeat Steps 1–3.
- If you did not connect an AC adapter, you can only adjust the display contrast from 1 to 3, and

only after you pick up the handset.

4. When you finish adjusting the contrast, press **DELETE** to return to the main display.

SETTING THE RINGER VOLUME

To set the ringer's volume for LINE 1 or LINE 2, set the correlating **L1 RINGER** or **L2 RINGER** to **HIGH**, **LOW**, or **OFF**.

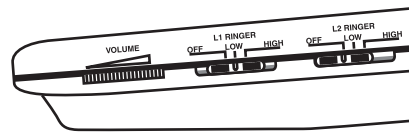

Note: You can still answer calls if you hear an extension phone ringing, and you can still make calls.

SETTING THE DIALING MODE

Set **TONE/PULSE** for the type of service you have, tone or pulse. If you are not sure which type you have, do this test.

1. Set **TONE/PULSE** to **TONE**.

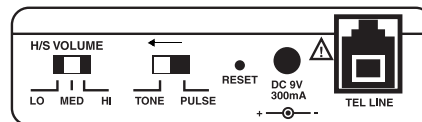

2. Pick up the handset and listen for a dial tone.

3. When you hear the dial tone, press any number other than **0**.

Note: If your phone system requires that you dial an access code (9, for example) before you dial an outside number, do not press the access code number.

- *If the dial tone stops, you have touch-tone service. Leave **TONE/PULSE** set to **TONE**.*
- *If the dial tone continues, you have pulse service. Set **TONE/PULSE** to **PULSE**.*

place the batteries with fresh ones, then reconnect it and try initializing it again.

INITIALIZING THE SYSTEM

Before you use the phone the first time or any time you need to reset the phone's clock, use a pointed object, such as a straightened paper clip, to press **RESET**. **12:00 AM** appears on the display.

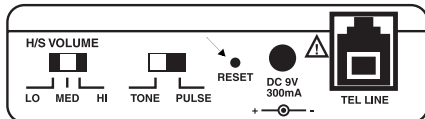

Notes:

- The telephone company sends the correct time with each incoming call, so the correct date and time are automatically set when the phone receives its first call.
- If the system does not work after you initialize it, remove the batteries, disconnect the system from the phone line and the AC outlet, re-

OPERATION

MAKING AND RECEIVING CALLS

To make a call using the handset, pick it up. When you hear the dial tone, dial the number. Then current time disappears, and the number appears on the display as you dial it. When you complete the call, hang up the handset. The number disappears from the display, and the current time reappears.

When you receive a call, the system rings (if you set the **RINGER** switch to **HIGH** or **LOW**). To answer the call, pick up the handset.

Adjusting the Handset Volume

To adjust the handset volume before or during a call, set **H/S VOLUME** to **LOW/MED/HI** for a comfortable listening level.

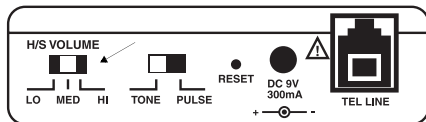

Using the Speakerphone

Follow these steps to make a call using the speakerphone.

1. Rotate **VOLUME** toward the narrow end of the arrow until it stops.

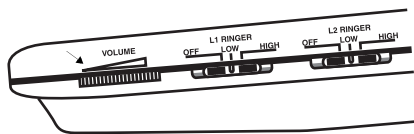

2. Press **LINE 1** or **LINE 2**. The speakerphone turns on and sounds a dial

tone. **PLEASE DIAL** and **LINE 1** or **LINE 2** appear on the display according to the line in use. The **SPEAKERPHONE** and **LINE 1** or **LINE 2** indicators light.

3. Adjust **VOLUME** to a comfortable listening level.
4. Dial the number. The number appears on the display as you dial it.
5. To end the call, press **SPEAKERPHONE**. The **SPEAKERPHONE** indicator turns off. Then the current time reappears on the display.

Notes:

- When you use the speakerphone, you and the other caller cannot hear each other if you both speak at the same time.
- If the system is close to loud noises while you are using the speakerphone, the system might not switch to let you hear the person on the other end of the line. If this happens, press **MUTE** to turn off the microphone so you can hear the caller (see "Using Mute" on Page 15). **PRIVACY** appears on the display.

To answer an incoming call using the speakerphone, press **SPEAKERPHONE**, **LINE 1** or **LINE 2**.

To switch from the handset to the speakerphone, press **SPEAKERPHONE**. The **SPEAKERPHONE** and **LINE 1** or **LINE 2** indicators light. Then hang up the handset.

To switch from the speakerphone to the handset, simply pick up the handset.

New Call Indicator

The NEW CALL indicator blinks if the system has either voice mail or a new call in call memory. The NEW CALL indicator stops blinking if you have reviewed all the voice mail messages and new calls.

USING MUTE

During a call, press **MUTE** to talk to someone else in the room without the person on the other end of the line hearing your conversation. **PRIVACY** appears on the display.

Press **MUTE** again to resume your phone conversation.

USING FLASH

FLASH performs the electronic equivalent of a switchhook operation for special services, such as Call Waiting.

For example, if you have Call Waiting, press **FLASH** to answer an incoming call without disconnecting the current call. **F** appears on the display to the right of the displayed numbers. Press **FLASH** again to return to the first call.

Notes:

- If you do not have any special phone services, pressing **FLASH** might disconnect the current call.
- Pressing **FLASH** does not hang up the system.
- You can store a **FLASH** entry when you store a number in memory.

USING REDIAL

Note: The redial memory holds up to 24 digits, so you can redial long distance as well as local phone numbers.

To quickly redial the last number dialed, press **SPEAKERPHONE** or pick up the handset, press **LINE 1** or **LINE 2** to select a line, then press **REDIAL** when you hear a dial tone. The number scrolls across the display, and the phone dials it.

USING HOLD

To place a call on hold, press **HOLD**. The line's indicator flashes slowly.

Note: Press the other line button without pressing **HOLD** to disconnect the current call on hold.

To release a call from hold, press that line's button and begin speaking again. You can also release a call from hold by picking up any extension phone on that line.

IDENTIFYING THE INDICATORS

Your phone has line status indicators that use ringing tones, the display, and indicator lights to let you know if a call is coming in, on hold, or a line is in use.

Ringer Indicators

To indicate which line has an incoming call, Line 2 has a higher sounding ring than Line 1.

Display and Light Indicators

Display Information	Light Indicator	Situation
LINE 1 RINGING	LINE 1 blinks.	Line 1 is ringing.
LINE 2 RINGING	LINE 2 blinks.	Line 2 is ringing.
LINE 1 & 2 RINGING	LINE 1 and 2 blink.	Both Line 1 and Line 2 are ringing.
LINE 1 HELD	LINE 1 blinks.	Line 1 is held.
LINE 2 HELD	LINE 2 blinks.	Line 2 is held.
BOTH LINES HELD	LINE 1 and 2 blink.	Both Line 1 and Line 2 are held.
LINE 1 EXTENTION	LINE 1 lights.	An extension phone on Line 1 is in use.
LINE 2 EXTENTION	LINE 2 lights.	An extension phone on Line 2 is in use.
LINE 1 EXTENTION on hold	LINE 1 blinks.	Line1 is held by an extension phone.
LINE 2 EXTENTION on hold	LINE 2 blinks.	Line 2 is held by an extension phone.
BOTH LINES EXT.	LINE 1 and 2 light.	Both Line 1 and Line 2 are in use by extension phones.
BOTH LINES EXT. L1 on hold	LINE 1 blinks and LINE 2 lights.	Line 1 is held by another extension phone and Line 2 is in use by an extension phone.
BOTH LINES EXT. L2 on hold	LINE 1 lights and LINE 2 blinks.	Line 1 is in use by an extension phone and Line 2 is held by another extension phone.
BOTH LINES EXT. on hold	LINE 1 and 2 blink.	Both Line 1 and Line 2 are held by extension phones.

USING CALLER ID

If you subscribe to a Caller ID service, the phone automatically displays information about calls you receive and stores the information in Caller ID memory. The system can store up to 99 incoming phone numbers, or up to 68 incoming names and phone numbers into call records.

During an incoming call, the phone company automatically sends the correct time between the first and second rings to update your system's display (if you subscribe to Caller ID service).

The first line of the call record shows the name (if available) of the caller. The second line shows the phone number of the caller. The third line shows the time, date and number of the calls.

Caller ID Display Information

Refer to this chart to help you interpret the display's information.

Display	Situation
LINE 1	Appears on the left top of the display if the call is from Line 1.
LINE 2	Appears on the left top of the display if the call is from Line 2.
L-D-C	Appears when an incoming call is long distance.
	Appears the first time you review a call's information.

Display	Situation
x 	Appears if there are one or more incoming new calls saved in memory. X indicates the number of new calls.
XX CALLS	Appears when there are a total of XX Caller ID records stored in the phone.
0 CALL	Appears if you review incoming call records and there are no calls.
#XX	Indicates the sequence number of the current call record (for example, #1 is the oldest call).
x x	Appears if the call was a repeat call. x shows how many times the caller called.
CALL-Fd	Appears instead of the phone number if the call was forwarded to you by a phone which was set to forward all calls (using the phone company's call forwarding service). The display flashes between CALL-Fd and the call record.
CALL-Fd BUSY	Appears instead of the phone number if the call was forwarded to you by a phone set to forward any busy calls, and the number the caller dialed was busy. The display flashes between CALL-Fd BUSY and the call record.

Display	Situation
ERROR	Appears if the Caller ID information was garbled. It is normal for this to happen occasionally. If this happens often, contact your local phone company and ask them to correct the problem.
LINE 1 MESSAGE LINE 2 MESSAGE or LINE 1 & 2 MESSAGE	Appears if you subscribe to a message waiting service and a message is waiting. If MESSAGE appears and you subscribe to message waiting, retrieve the messages as instructed by your service provider. If MESSAGE appears and you do not have message waiting, press DELETE twice and MESSAGE disappears.
PRIVATE NAME/PRIVATE NUMBER	Appears if the caller chose to block sending Caller ID information. No caller information appears.
?	Appears within the Caller ID information if one or more characters were not properly received. It is normal for this to happen occasionally. If this happens often, contact your local phone company and ask them to correct the problem.

Display	Situation
UNKNOWN NUMBER/UNKNOWN NAME	Appears if the caller is not within a Caller ID service area, or during the following types of incoming calls: <ul style="list-style-type: none"> • Long-distance calls (except when the long-distance phone company used for the call transmits Caller ID information) • Operator-assisted calls • Calls made from a cellular phone • Calls made with a credit card
-----	Appears if a caller's number or name was not transmitted during a call.

Reviewing Call Records

To quickly review call records from newest to oldest, repeatedly press **REVIEW ▲**. To review call records from oldest to newest, repeatedly press **REVIEW ▼**. If you have not received any new calls, **0 CALL** is displayed.

Notes:

- If you do not press any button within 30 seconds while you are reviewing call records, the system automatically returns to the current time display.

- If a displayed phone number is more than twelve characters, the rest of the Caller ID information scrolls automatically.

Area Code

Your phone allows you to pre-store five area codes of three digits. When you dial a Caller ID number by pressing the **CALL BACK** button, only the last seven digits will be dialed if the area code of the dialed Caller ID number matches one of the area codes you stored previously.

Follow these steps to store an area code:

1. Press **STORE**. **LOCATION?** appears on the display.
2. Press **CALL BACK**. **AREA CODE NO. 1** appears on the display.
3. Press **REVIEW** ▲ or ▼ to select a location (1–5) where you want to store the area code.
4. Enter the area code you want to store using the number keys (0–9).
5. Press **STORE**. The phone sounds a tone.
6. Press **STORE** again to exit.

Note: You may edit a stored area code by repeating Steps 1– 4.

Follow these steps to review stored area codes.

1. Press **STORE**. **LOCATION?** appears on the display.

2. Press **CALL BACK**. **AREA CODE NO. 1** appears.
3. Press **REVIEW** ▲ or ▼ to review the area codes which you stored previously.
4. Press **STORE** to exit.

Follows these steps to delete stored area codes.

1. Press **STORE**. **LOCATION?** appears.
2. Press **CALL BACK**. **AREA CODE NO. 1** appears.
3. Press **REVIEW** ▲ or ▼ to select the area code you want to delete.
4. Press **DELETE**.
5. Press **STORE** to exit.

Dialing Numbers In Call Records

For your phone's Caller ID memory dial feature to operate, the record must contain the caller's number.

Follow these steps to dial a number stored in a call record.

1. Press **LINE 1** or **LINE 2** to select a phone line.
2. Repeatedly press **REVIEW** ▲ or ▼ until the phone number you want to dial appears.
3. *If the Caller ID record has the same area code as one you have stored, press **CALL BACK** and the phone dials only the last 7 digits of the number.*

*If the Caller ID record has the same area code as one you have stored but you need to include the area code to make the call, dial the area code on the number key pad then press **CALL BACK**.*

*If the Caller ID record has a different area code than one you have stored, press **1** then press **CALL BACK**.*

Deleting Call Records

You can select and delete an individual call record, or all call records stored in the system.

Note: When the phone's memory is full, it automatically replaces the oldest call record with the newest incoming call.

*To delete a single call record, repeatedly press **REVIEW** ▲ or ▼ until the call record you want to delete appears.*

When the phone displays the call record, press **DELETE** twice within 30 seconds. The phone beeps, deletes the call record, and automatically renumbers the remaining call records. Then, after 30 seconds, the current time reappears.

*To delete all of the call records at once, press **REVIEW** ▲ or ▼ repeatedly until **XX CALLS** appears on the display. Press and hold down **DELETE** for about 5 seconds. The system beeps and deletes all call records, and **0 CALL** appears.*

Note: If you do not press any button within 30 seconds while deleting call records, the phone automatically returns to the current time display.

Storing Call Records Into Memory Locations

You can move phone numbers from Caller ID records into the phone's upper or lower memory locations. See "Storing Call Records Into Memory" on Page 21.

MEMORY DIALING

You can store phone numbers (up to 24 digits) and call records in the system's 20 (10 upper, 10 lower) memory locations. You can dial a phone number with the touch of one memory location button.

Storing a Pause In Memory

In some telephone systems, you must dial an access code (9, for example) and wait for a 2 second dial tone before you can dial an outside number. When storing a number with an access code, you should also store a pause after the access code to allow the outside line time to connect.

To store a 2-second pause, press **PAUSE** at the desired point in the phone number. **P** appears on the display. For a longer pause, press **PAUSE** additional times.

Storing Numbers Into Memory

Note: For information about storing numbers from call records into memory see “Storing Call Records Into Memory”.

Follow these steps to store numbers into upper or lower memory.

1. Press **STORE**. **LOCATION?** appears.
2. Choose the memory location where you want to store the number.
 - For an upper memory location, press a memory button.
 - For a lower memory location, press **LOWER**, **LOWER** appears on the display, then press a memory button.

INPUT NUMBER: appears at the top of the display.

3. Enter the number you want to store, including any flash and pause entries.

Notes:

- Each flash or pause entry uses one digit of memory.
 - If you make a mistake while entering the number, repeatedly press **DELETE** until you delete the incorrect digit. Then re-enter the correct number.
4. Within 30 seconds after entering the number, press **STORE**. The system beeps, then stores the number.

Notes:

- If you do not press **STORE** within 30 seconds, the system returns to

the current time display. To start over, repeat Steps 1–4.

- If you answer a call before pressing **STORE**, you must begin the procedure again after you complete the call.
- If you have pulse service, press ***** to store a switch from pulse to tone mode at the appropriate place in your number.

Storing Call Records Into Memory

You can move call records (including stored numbers) from Caller ID memory into the phone’s memory locations.

Follow these steps to move Caller ID records to memory locations:

1. Repeatedly press **REVIEW** ▲ or ▼ to select the Caller ID record you want to store.
2. Press **STORE**. **LOCATION?** appears on the display.
3. Within 30 seconds, choose a memory location where you want to store the number. The phone sounds a tone and stores the number.
 - For an upper memory location, press a memory button.
 - For a lower memory location, press **LOWER** and then a memory button.

Note: If you do not specify a memory location within 30 seconds, the system returns to the current time display. To start over, repeat Steps 1–3.

Storing the Last Number Dialed Into Memory

Follow these steps to store the last number you dialed to a memory location.

1. Press **REDIAL**. The last dialed number appears on the display.
2. Press **STORE LOCATION?** appears.
3. Within 30 seconds, specify the memory location where you want to store the number.
 - For an upper memory location, simply press a memory button.
 - For a lower memory location, press **LOWER** and then a memory button.

The system beeps and stores the number.

Note: If you do not specify a memory location within 30 seconds, the system returns to the current time display. To start over, repeat Steps 1–3.

Storing Special Service Numbers

For a quick recall of numbers for special services (such as bank-by-phone or alternate long-distance), you can store each group of numbers in its own memory location. Then, when calling special services, dial the service's main numbers first. At the appropriate place in the call, press the memory location button for the additional numbers you want to send.

To store a number for a special service, follow the steps under "Storing Numbers Into Memory" on Page 21.

Caution: To prevent unauthorized access to special services, we recommend that you do not store a personal identification number in memory.

Using the Quick Reference Card

There is a quick reference card that offers brief phone operation instructions on "Storing a Number Into Memory" and "Dialing a Stored Number" located on a pull out sleeve on the bottom of the phone. To view the card, gently pull the tab on the bottom of the phone outward. When you finish reading the instructions, gently press the sleeve back under the phone.

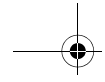

Using the Memory Card

To keep a record of the numbers you stored in the phone's upper and lower memory locations, lift off the clear plastic cover over the card surrounding the memory buttons. Then write the person's or company's name next to the appropriate memory location. Replace the clear plastic cover.

Reviewing Stored Numbers

To review a number stored in an upper memory location, press the desired memory location button.

To review a number stored in a lower memory location, press **LOWER**, and then press the desired memory button.

Note: Only the last fourteen digits of the stored number appear on the display. If there is no memory stored, **EMPTY** appears on the display.

Dialing Stored Numbers

If you are dialing a number stored in upper or lower memory, lift the handset or press **SPEAKERPHONE** and press **LINE 1** or **LINE 2** to select which telephone line you prefer.

To dial a number stored in upper memory, press the desired memory location button.

To dial a number stored in lower memory, press **LOWER**, then press the desired memory location button.

Deleting Stored Numbers

To delete a number stored in memory, press the memory location button for the number you want to delete, then press **DELETE** twice.

To replace a number stored in memory with another number, see "Storing Numbers Into Memory" on Page 21.

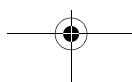
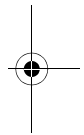
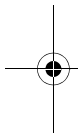

TROUBLESHOOTING

We do not expect you to have any problems with your phone, but if you do, the following suggestions might help.

Problem	Suggestion
The phone does not work.	Make sure the phone line cord connected properly.
The phone does not ring.	Make sure the RINGER switch, it may be set to OFF .
No dial tone.	<ul style="list-style-type: none"> • Make sure the coiled handset cord is connected properly?.Check the phone jack with a known working phone.
Cannot dial.	<ul style="list-style-type: none"> • Make sure the you have touch tone service. See "Setting the Dialing Mode" on Page 12. • Check the TONE/PULSE switch setting.
Other party cannot hear.	Make sure the handset cord connected properly.
Display showing erroneous figures.	Remove batteries and press RESET .
The display is faded.	<ul style="list-style-type: none"> • Adjust the display contrast. See "Adjusting the Display Contrast" on Page 12. • Make sure the batteries are correctly installed?
CALLER ID does not work.	<ul style="list-style-type: none"> • You must subscribe to a CALLER ID service. • Make sure the AC adapter is connected.
No caller's name.	Make sure the Caller ID service to which you subscribe is include the caller name delivery feature.

If you still have problems, disconnect the phone. If other phones on the same line work properly, the fault is in this phone or its installation. If you cannot find the problem, take the phone to your local RadioShack store for assistance.

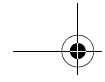

CARE AND MAINTENANCE

Your RadioShack Two-Line Caller ID Phone is an example of superior design and craftsmanship. The following suggestions will help you care for your phone so you can enjoy it for years.



Keep the phone dry. If it gets wet, wipe it dry immediately. Liquids might contain minerals that can corrode the electronic circuits.



Use and store the phone only in normal temperature environments. Temperature extremes can shorten the life of electronic devices, damage batteries, and distort or melt plastic parts.



Keep the phone away from dust and dirt, which can cause premature wear of parts.



Handle the phone gently and carefully. Dropping it can damage circuit boards and cases and can cause the phone to work improperly.



Use only fresh batteries of the required size and recommended type. Batteries can leak chemicals that damage your phone's electronic parts.



Wipe the phone with a damp cloth occasionally to keep it looking new. Do not use harsh chemicals, cleaning solvents, or strong detergents to clean the phone.

Modifying or tampering with the phone's internal components can cause a malfunction and might invalidate its warranty and void your FCC authorization to operate it. If your phone is not performing as it should, take it to your local RadioShack store for assistance. If the trouble is affecting the telephone lines, the phone company can ask you to disconnect your phone until you have resolved the problem.



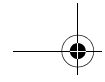

THE FCC WANTS YOU TO KNOW

In the unlikely event that your system causes problems on the phone line, the phone company can temporarily disconnect your service. If this happens, the phone company attempts to notify you as soon as possible and advise you of your right to file a complaint with the FCC.

Also, the phone company can make changes to its lines, equipment, operations, or procedures that could affect the operation of the system. The phone company notifies you of these changes in advance, so you can take the necessary steps to prevent interruption of your phone service.

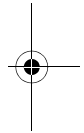
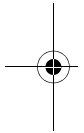

LIGHTNING

Your Caller ID Phone has built-in protection circuits to reduce the risk of damage from surges in telephone line current. These protection circuits meet or exceed the FCC requirements. However, lightning striking the telephone lines can damage your system.

Lightning damage is not common. Nevertheless, if you live in an area that has severe electrical storms, we suggest that you unplug your system during storms to reduce possibility of damage.

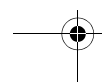
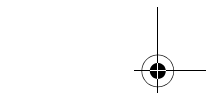
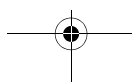

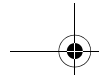

NOTES

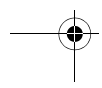
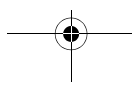
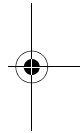
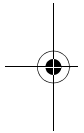

Limited One-Year Warranty

This product is warranted by RadioShack against manufacturing defects in material and workmanship under normal use for one (1) year from the date of purchase from RadioShack company-owned stores and authorized RadioShack franchisees and dealers. EXCEPT AS PROVIDED HEREIN, RadioShack MAKES NO EXPRESS WARRANTIES AND ANY IMPLIED WARRANTIES, INCLUDING THOSE OF MERCHANTABILITY AND FITNESS FOR A PARTICULAR PURPOSE, ARE LIMITED IN DURATION TO THE DURATION OF THE WRITTEN LIMITED WARRANTIES CONTAINED HEREIN. EXCEPT AS PROVIDED HEREIN, RadioShack SHALL HAVE NO LIABILITY OR RESPONSIBILITY TO CUSTOMER OR ANY OTHER PERSON OR ENTITY WITH RESPECT TO ANY LIABILITY, LOSS OR DAMAGE CAUSED DIRECTLY OR INDIRECTLY BY USE OR PERFORMANCE OF THE PRODUCT OR ARISING OUT OF ANY BREACH OF THIS WARRANTY, INCLUDING, BUT NOT LIMITED TO, ANY DAMAGES RESULTING FROM INCONVENIENCE, LOSS OF TIME, DATA, PROPERTY, REVENUE, OR PROFIT OR ANY INDIRECT, SPECIAL, INCIDENTAL, OR CONSEQUENTIAL DAMAGES, EVEN IF RadioShack HAS BEEN ADVISED OF THE POSSIBILITY OF SUCH DAMAGES.

Some states do not allow limitations on how long an implied warranty lasts or the exclusion or limitation of incidental or consequential damages, so the above limitations or exclusions may not apply to you.

In the event of a product defect during the warranty period, take the product and the RadioShack sales receipt as proof of purchase date to any RadioShack store. RadioShack will, at its option, unless otherwise provided by law: (a) correct the defect by product repair without charge for parts and labor; (b) replace the product with one of the same or similar design; or (c) refund the purchase price. All replaced parts and products, and products on which a refund is made, become the property of RadioShack. New or reconditioned parts and products may be used in the performance of warranty service. Repaired or replaced parts and products are warranted for the remainder of the original warranty period. You will be charged for repair or replacement of the product made after the expiration of the warranty period.

This warranty does not cover: (a) damage or failure caused by or attributable to acts of God, abuse, accident, misuse, improper or abnormal usage, failure to follow instructions, improper installation or maintenance, alteration, lightning or other incidence of excess voltage or current; (b) any repairs other than those provided by a RadioShack Authorized Service Facility; (c) consumables such as fuses or batteries; (d) cosmetic damage; (e) transportation, shipping or insurance costs; or (f) costs of product removal, installation, set-up service adjustment or reinstallation.

This warranty gives you specific legal rights, and you may also have other rights which vary from state to state.

RadioShack Customer Relations, 200 Taylor Street, 6th Floor, Fort Worth, TX 76102

We Service What We Sell

12/99

RadioShack
A Division of Tandy Corporation
Fort Worth, Texas 76102

01A00

Printed in China