



Cat. No. 43-774
OWNER'S MANUAL

Please read before using this equipment.

TAD-1015

**25-Channel Cordless Telephone
High-Capacity Digital Answering System**



RadioShack®

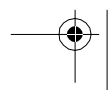

FEATURES

Your RadioShack TAD-1015 25-Channel Cordless Telephone High-Capacity Digital Answering System uses advanced analog cordless telephone technology to give you superior audio quality. Its cordless operation lets you move freely around your home or office.

The TAD (Telephone Answering Device) stores all messages on a computer chip. This gives you advanced capabilities over tape-based answering machines. For example, you can delete individual messages while the rest are saved. Because your TAD is fully digital, there are no tapes to bother with, no tape mechanisms to wear out, and no lost messages if power fails.

Its remote operation feature lets you access your TAD from a touch-tone phone, and guides you through system operation with voice prompts.

Telephone Features

25 Channels — lets you change to another channel if you hear interference.

Security Access-Protection Code — minimizes the chances of other cordless phones using your phone line.

Redial — lets you quickly dial the last number dialed.

10-Number Memory Dialing — lets you store up to 10 phone numbers in memory for easy dialing.

Paging System — lets you send a signal from the base to the handset so you can page someone or easily locate the handset when it is away from the base.

Flash — sends an electronic switch-hook signal for use with special phone services such as Call Waiting.

Tone or Pulse Dialing — lets you use your phone with either type of dialing.

Hearing Aid Compatible — lets you use this telephone with hearing aids that have a T (telephone) switch.

TAD Features

Date/Time Stamp — records the day and time each message was recorded.

Digitally-Synthesized Voice — guides you through operation of the system.

Digital Volume Control — lets you adjust the volume of incoming message playback.

Pre-recorded Messages — give you the option of using existing outgoing messages or recording your own.

© 1997 Tandy Corporation.
All Rights Reserved.

RadioShack is a registered trademark used by Tandy Corporation.

Announcement Only — lets you play an announcement for callers to hear, without recording their messages.

LED Digital Message Counter — shows the number of messages the TAD has recorded.

Remote Operation — lets you use a touch-tone phone (or rotary phone and pocket tone dialer) to operate the TAD while you are away from your home or office.

Programmable PIN — you can set a two digit personal identification number (PIN) for secure remote operation.

Remote Answer-On — lets you call the TAD from a remote location even when it is not set to answer calls.

Call Screening — lets you listen as a caller leaves a message so you can decide whether or not to answer the call.

Memo Recording — lets you leave messages for yourself or others in your home or office.

Adjustable Ring Number — lets you set the TAD to answer after two or five rings.

Toll-Saver — lets you avoid unnecessary long-distance charges when you call by long distance to check your messages.



Phone Pick-Up Detection — stops recording when you pick up any phone on the same line as the TAD, and resets to answer the next call.

We recommend you record the telephone's serial number here. The number is on the bottom of the base.

Serial Number _____

This TAD has been tested and found to comply with all applicable UL and FCC standards.

Warning: To prevent fire or shock hazard, do not expose this product to rain or moisture.

	CAUTION RISK OF ELECTRIC SHOCK. DO NOT OPEN.	
CAUTION: TO REDUCE THE RISK OF ELECTRIC SHOCK, DO NOT REMOVE COVER OR BACK. NO USER-SERVICEABLE PARTS INSIDE. REFER SERVICING TO QUALIFIED PERSONNEL.		



This symbol is intended to alert you to the presence of uninsulated dangerous voltage within the product's enclosure that might be of sufficient magnitude to constitute a risk of electric shock. Do not open the product's case.



This symbol is intended to inform you that important operating and maintenance instructions are included in the literature accompanying this product.



Important: Cordless phones such as this one require AC power to operate. When AC power is off, you cannot dial out or receive incoming calls using your TAD-1015. For this reason, the TAD-1015 should not be your only telephone. To be safe, you should also have a phone that does not require AC power to operate (not a cordless phone) so you can still make and receive calls if there is an AC power failure.

READ THIS BEFORE INSTALLATION

Your telephone conforms to federal regulations, and you can connect it to most telephone lines. However, each device you connect to the phone line draws power from the phone line. We refer to this power draw as the device's *ringer equivalence number*, or REN. The REN is on the label on the back of the base.

If you are using more than one phone or other device on the line, add up all the RENs. If the total is more than five, your phone might not ring and your answering system might not answer. In rural areas, a total REN of three might impair ringer operation. If ringer operation is impaired, remove a device from the line.

FCC STATEMENT

This telephone complies with Part 68 of *FCC Rules*. You must, upon request, provide the FCC Registration Number and the REN to your phone company. These numbers are on the label on the back of the base.

You must not connect your phone to any of the following:

- Coin-operated systems
- Party-line systems
- Most electronic key phone systems

Note: Your telephone operates on standard radio frequencies, as allocated by the FCC. Even though the security access-protection code prevents unauthorized use of your phone line, it is possible for other radio units operating on similar frequencies within a certain area to unintentionally intercept your conversations and/or cause interference. This lack of privacy can occur with any cordless phone.

CONTENTS

Installation	7
Selecting a Location	7
Placing the Base on a Desktop	7
Mounting the Base on a Wall Plate	8
Mounting the Base Directly on the Wall	10
Removing the Protective Sheet	11
Preparation	12
Connecting and Charging the Battery Pack	12
Setting the Dialing Mode	13
Turning the Base's Ringer Off/On	14
Telephone Operation	15
Making and Receiving Calls	15
Changing the Channel	15
Using Redial	15
Using Flash	16
Using Tone Services on a Pulse Line	16
Paging	16
Memory Dialing	17
Storing a Number in Memory	17
Entering a Pause	18
Dialing a Stored Number	18
Chain-Dialing Service Numbers	18
Testing Stored Emergency Numbers	18
TAD Operation	19
Using the Handset to Control the TAD	19
Setting the Number of Rings	19
Setting the Remote Operation PIN	20
Setting the Day and Time	20
Selecting an Outgoing Message	21
Recording an Outgoing Message	21
Setting the TAD to Answer Calls	22
Screening Calls	23
Recording a Memo	23
Playing Messages	23
Deleting Messages	25
Adjusting the TAD's Volume	25



Remote Operation 26
 Using the Toll-Saver 26
 Accessing the TAD by Remote 26

Troubleshooting 28

Care and Maintenance 30
 Replacing the Battery Pack 31
 The FCC Wants You to Know 32
 Lightning 33

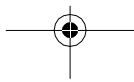

INSTALLATION

SELECTING A LOCATION

You can set the TAD-1015's base on a flat surface (such as a desk or counter top), or mount it on a wall plate or directly on the wall. The base's location affects the phone's range, so if you have a choice of several locations, try each to see which gives the best performance.

Select a location that is:

- Near an AC outlet
- Near a modular telephone line jack
- Away from electrical machinery, electrical appliances, and metal walls or filing cabinets
- Away from wireless intercoms, alarms, and room monitors

If the phone line jack is not a modular jack, you must update the wiring. You can convert the wiring yourself, using jacks and adapters available at your local RadioShack store. Or, you can let the phone company update the wiring for you. The USOC number of the jack to be installed is RJ11C.

Placing the Base on a Desktop

1. Plug one end of the supplied modular cord into the **TEL LINE** jack on the back of the base.

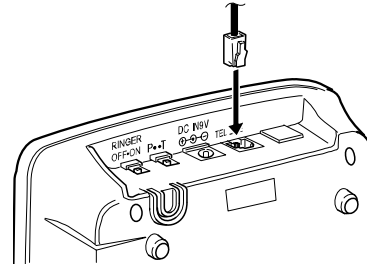

2. Plug the modular cord's other end into a modular phone line jack.

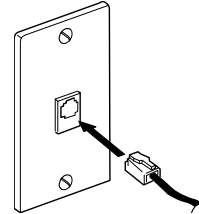

3. Insert the supplied AC adapter's barrel plug into the **DC IN 9V** jack on the back of the base.

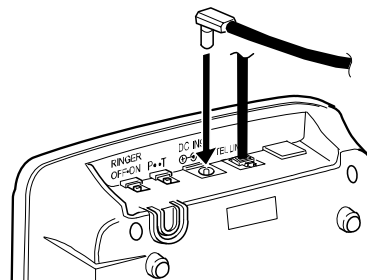

4. Route the adapter's cord through the strain relief slot on the back of the base.

Strain Relief Slot

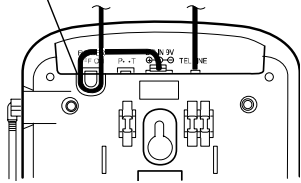

5. Plug the adapter into a standard AC outlet. The POWER indicator on the base lights.

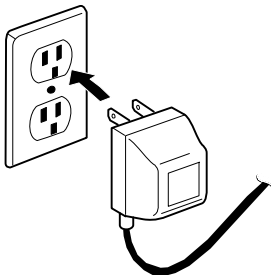

Mounting the Base on a Wall Plate

To make this connection, you need a short modular cord, such as RadioShack Cat. No. 279-390 (not supplied).

1. Plug one end of the modular cord into the **TEL LINE** jack on the back of the base.

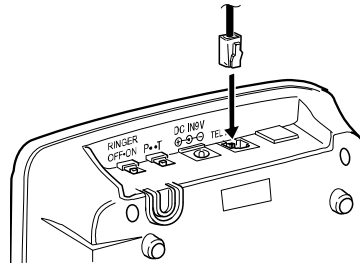

2. Plug the supplied AC adapter's barrel plug into the **DC IN 9V** jack.

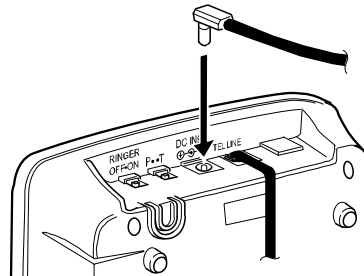

6. Fully extend the base's antenna and place it in a vertical position.

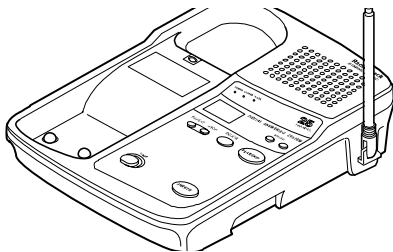

3. Route the adapter cord through the upper and lower grooves and the modular cord through only the upper groove on the bottom of the base.

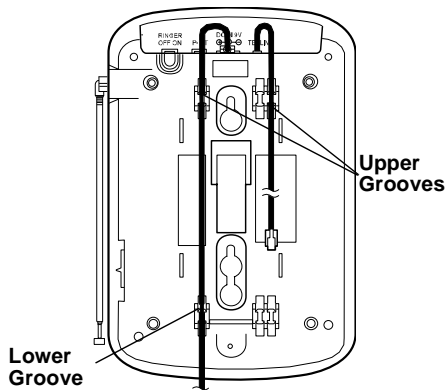

4. Plug the modular cord's other end into the wall plate jack, then align the base's keyhole slots with the wall plate studs and slide the base downward to secure it.

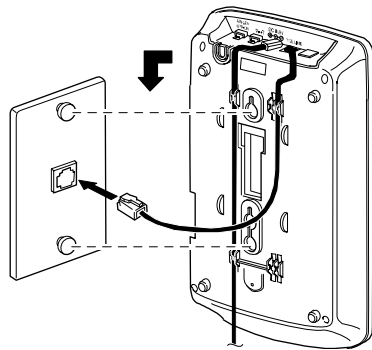

5. Plug the adapter into a standard AC outlet. The POWER indicator on the base lights.

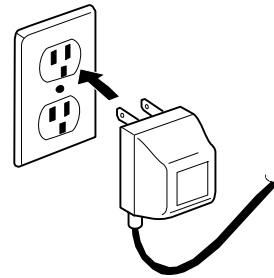

6. Press and lift out the handset holder, rotate it 180°, then snap it back into place so it holds the handset.

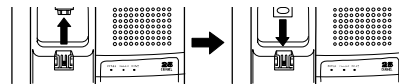

7. Fully extend the base's antenna and raise it to a vertical position.

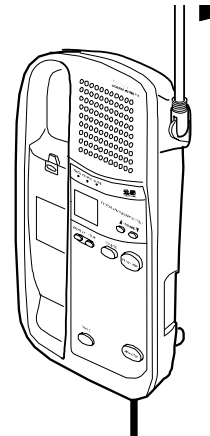

Mounting the Base Directly on the Wall

To mount the base directly on the wall, you need two wood screws (not supplied) with heads that fit into the keyhole slots on the bottom of the base.

1. Drill two holes $3\frac{15}{16}$ inches apart. Then thread a screw into each hole, letting the heads extend about $\frac{5}{16}$ inch from the wall.

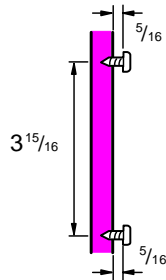

2. Plug one end of the modular cord into the **TEL LINE** jack on the back of the base.

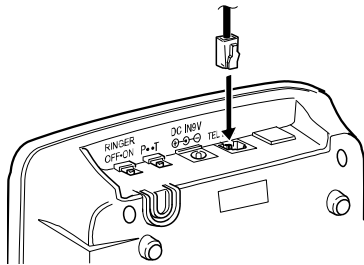

3. Plug the supplied AC adapter's barrel plug into the **DC IN 9V** jack.

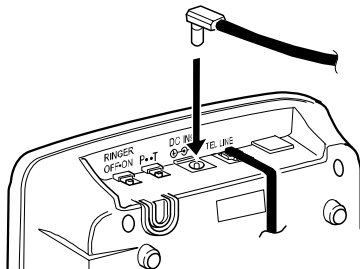

4. Route the adapter and modular cords through the upper and lower grooves on the bottom of the base.

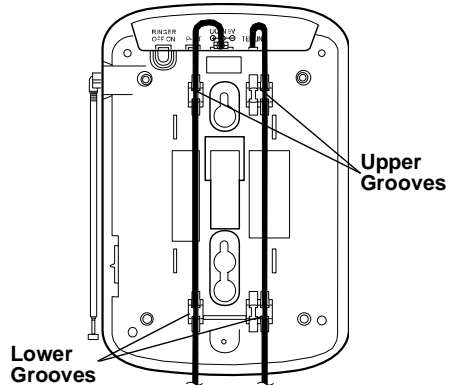

5. Align the keyhole slots with the mounting screws and slide the base downward to secure it.

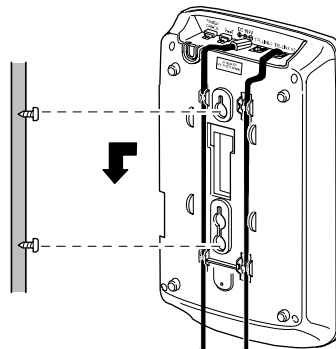

6. Plug the adapter into a standard AC outlet. The POWER indicator on the base lights.

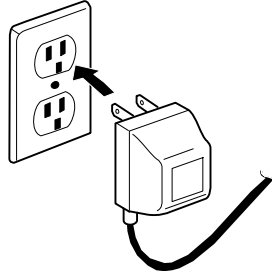

7. Plug the other end of the modular cord into a modular phone line jack.

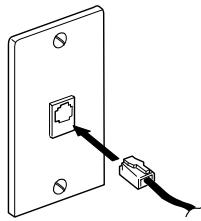

8. Press and lift out the handset holder, rotate it 180°, then snap it back into place so it holds the handset.

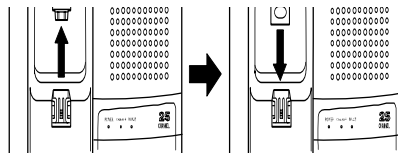

9. Fully extend the base's antenna and place it in a vertical position.

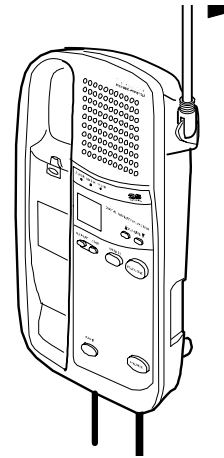

REMOVING THE PROTECTIVE SHEET

The base's digital display is covered with a transparent protective sheet to prevent damage during shipment and installation. After you install the base, peel off the sheet.

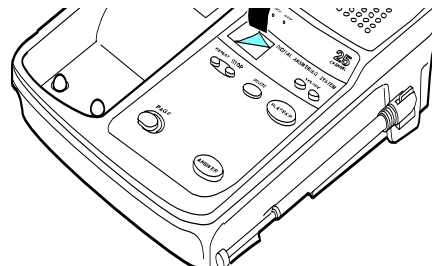

PREPARATION

CONNECTING AND CHARGING THE BATTERY PACK

The TAD-1015 comes with a rechargeable nickel-cadmium battery pack in the handset. Before using your phone, you must connect the battery, then charge it for about 18 hours.

1. Remove the screw from the battery compartment cover on the bottom of the handset, then press down and slide off the handset's cover.

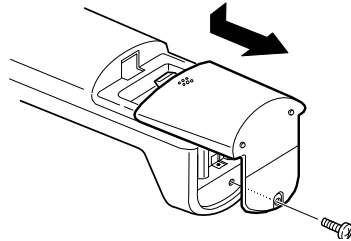

2. Plug the battery pack's plastic connector into the phone's socket. The connector fits only one way.

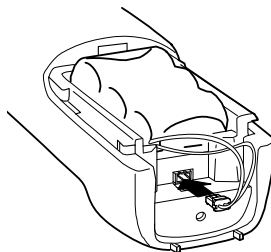

3. Replace the cover and tighten the screw.

4. To charge the battery pack, simply place the handset on the base. The CHARGE indicator on the base lights.

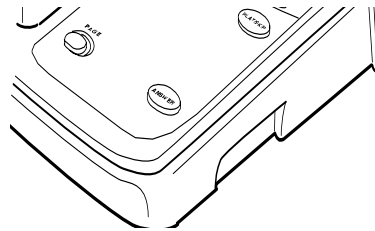

Recharge the battery pack when the BATT LOW indicator flashes.

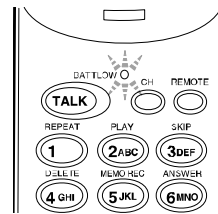

Notes:

- If the CHARGE indicator does not light when you place the handset on the base, be sure the battery pack and AC adapter are correctly and securely connected.
- When you first use the phone after charging or recharging the battery pack, the phone might not work and you might hear an error tone. If this happens, return the handset to the base for 5 seconds.

- Using a pencil eraser, clean the charging contacts on the handset and the base about once a month to make sure they are not dirty or tarnished.

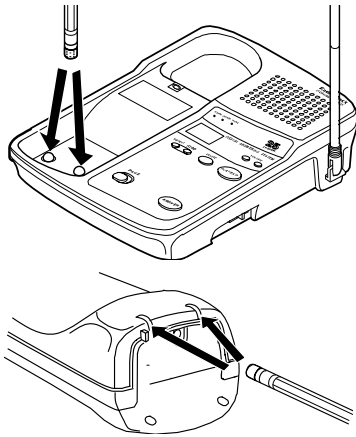

- About once a month, fully discharge the battery by keeping the handset off the base until the BATT LOW indicator lights. Otherwise, the battery pack loses its ability to fully recharge.
- If the BATT LOW indicator does not light, but the phone does not work, recharge the battery pack. (The battery charge might be too low to light the indicator.)
- If the battery pack gets weak during a call, a beep sounds about every 30 seconds, and the BATT LOW indicator flashes. If this happens, you cannot make another call using the handset until you recharge the battery pack.

- If the battery pack loses its charge completely, the handset loses the security access-protection code it uses to communicate with the base. To reset the security code and recharge the battery pack, place the handset on the base.
- The supplied battery pack should last about a year. When the battery pack loses its ability to fully recharge, order a replacement battery pack (see "Replacing the Battery Pack" on Page 31).

SETTING THE DIALING MODE

Set **P••T** on the back of the base for the type of service you have. If you are not sure which type you have, after you charge the handset battery pack, do this simple test.

1. Set **P••T** to **T** (tone).

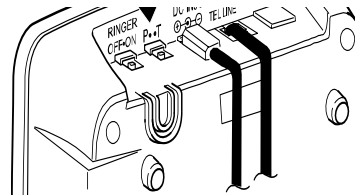

2. Lift the handset or press **TALK**, and listen for a dial tone.
3. Press any number other than **0**.

Note: If your phone system requires that you dial an access code (9, for example) before you dial an outside number, do not press the access code either.

If the dial tone stops, you have touch-tone service. Leave **P••T** set to **T**.

If the dial tone continues, you have pulse service. Set **P••T** to **P** (pulse).

4. To hang up, either place the handset on the base or press **TALK** on the handset.

TURNING THE BASE'S RINGER OFF/ON

To turn off the base's ringer, set **RINGER** on the back of the base to **OFF**. When a call comes in, any phone connected to the same line as the TAD-1015 and the handset (if it is off the base) still ring, but the base does not.

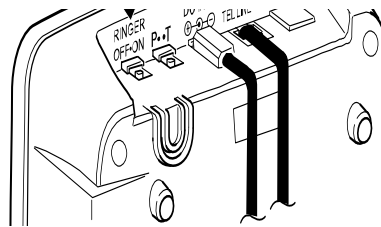

When you want the base to ring again, set **RINGER** to **ON**.

TELEPHONE OPERATION

MAKING AND RECEIVING CALLS

To make or answer a call, lift the handset. Or, if the handset is off the base, press **TALK**. The BATT LOW indicator on the handset and the IN USE indicator on the base light.

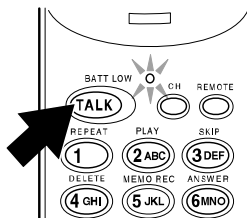

To end a call, place the handset on the base or press **TALK** on the handset.

Note: If you press **TALK** to hang up and the phone does not disconnect, press **TALK** again while holding the handset closer to the base or place the handset on the base.

CHANGING THE CHANNEL

If you notice interference, static, or noise during a call, press **CH** (channel) on the handset to find a clearer channel.

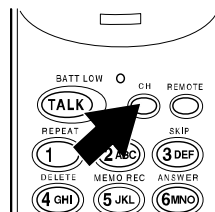

The TAD-1015 changes to a different channel each time you press **CH**.

Note: If the handset is too far from the base, the channel might not change. Move closer to the base and try again.

USING REDIAL

REDIAL lets you dial the last number dialed. When you hear a dial tone, simply press **REDIAL**.

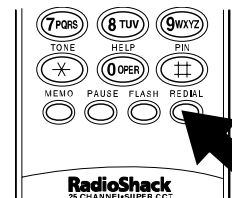

Notes:

- The redial memory holds up to 32 digits, so you can redial long-distance as well as local numbers.
- The redial memory also holds pause entries. See "Entering a Pause" on Page 18.
- The redial memory does not store a flash entry or any digits you press after **FLASH** (see "Using Flash" on Page 16).

USING FLASH

FLASH performs the electronic equivalent of a switchhook operation for special services, such as Call Waiting.

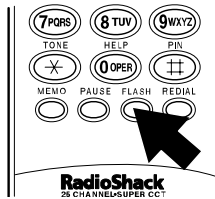

For example, if you have Call Waiting, press **FLASH** to answer an incoming call without disconnecting the current call. Press **FLASH** again to return to the first call.

Note: If you do not have any special phone services, pressing **FLASH** might disconnect the current call.

USING TONE SERVICES ON A PULSE LINE

Some special services, such as bank-by-phone, require tone signals. If you have pulse service, you can still use these special tone services by following these steps.

1. Be sure **P•T** is set to **P** (pulse).
2. Lift the handset from the base or press **TALK**.
3. Dial the service's main number.

4. When the service answers, press **TONE/***. Any additional numbers you dial are sent as tone signals.

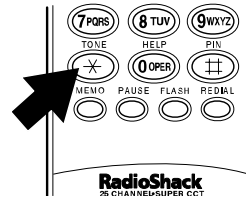

5. After you complete the call, return the handset to the base or press **TALK**. The phone automatically resets to the pulse mode.

PAGING

To send a page from the base to the handset, when the phone is not in use, press **PAGE** on the base. The handset beeps five times. If you hold down **PAGE** for more than 2 seconds, the handset beeps until you release it.

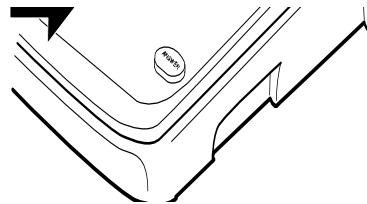

Note: Paging does not work while the phone is in use.

MEMORY DIALING

You can store up to 10 numbers in memory, then dial a stored number by pressing a one-digit memory location number.

Storing a Number in Memory

1. Lift the handset. If you hear a tone, press **TALK** to turn it off.
2. Press **MEMO**. The BATT LOW indicator flashes.

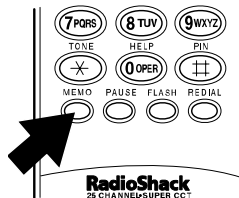

3. Enter the number and any tone or pause entries (see "Using Tone Services on a Pulse Line" on Page 16 and "Entering a Pause" on Page 18).

Notes:

- An error tone sounds and the phone exits the programming mode if you wait more than 20 seconds to press a key.
- Each number you store can be up to 16 digits long.
- Each tone or pause entry uses one digit of memory.

4. Press **MEMO**, then enter a memory location number (**0–9**). A tone sounds to indicate that the number is stored.

Note: If five quick beeps sound, you have made an entry error and the number was not stored. Start again from Step 2.

5. For each stored number, write the person's or company's name next to the appropriate location number on the supplied MEMORY directory sticker. (Use a pencil in case you want to change the number later.) Attach the sticker to the phone.

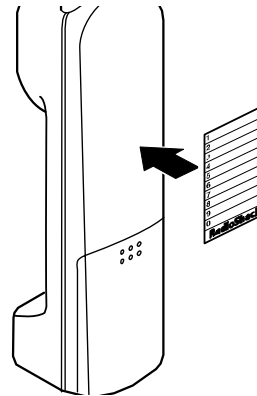

To erase a stored number, simply store a new number in its place. Or, skip Step 3 (press **MEMO** twice), then press the memory location number (**0–9**) you want to clear. A tone sounds.

Entering a Pause

In some telephone systems, you must dial an access code (9, for example) and wait for a second dial tone before you can dial an outside number. You can store the access code with the phone number. However, you should also store a pause after the access code to allow the outside line time to connect.

To enter a 2-second pause while storing a phone number, press **PAUSE**. For a longer pause, press **PAUSE** additional times.

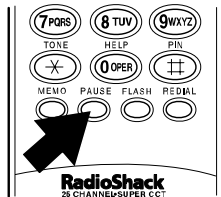

Dialing a Stored Number

To dial a stored number, lift the handset from the base or press **TALK**. When you hear a dial tone, press **MEMO** and enter the memory location number for the number you want to dial.

Chain-Dialing Service Numbers

When calling special services (such as alternate long distance or bank-by-phone), dial the service's main number first. Then, at the appropriate place in the call, press **MEMO** and the number for the location where the additional information is stored.

Testing Stored Emergency Numbers

If you store an emergency service's number (police department, fire department, ambulance) and you choose to test the stored number, make the test call during the late evening or early morning hours to avoid peak demand periods. Also, remain on the line to explain the reason for your call.

TAD OPERATION

You can use the base or the handset to control the TAD. With the handset you set the day and time, the remote operation personal identification number, record outgoing messages and memos, turn the TAD on and off, play messages, and delete messages. At the base you can set the number of rings before the TAD answers an incoming call, set the kind of outgoing message played and the incoming message recording time, turn the TAD on and off, play and delete messages, and adjust the TAD's volume.

Note: While you are using the base to control the TAD, you can still answer incoming calls. However, if you press TALK on the handset to answer the call, the handset beeps.

USING THE HANDSET TO CONTROL THE TAD

You control the TAD with the handset. Lift the handset and, if the BATT LOW indicator lights red, press TALK to turn it off. Then press REMOTE. The BATT LOW indicator on the handset lights green, and three bars flash alternately on the base's display.

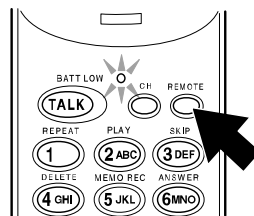

The TAD tells you the number of messages you have (if any), then announces the help messages through the handset. Then the TAD beeps when it is ready to accept a command.

Notes:

- You can skip the message count and the help messages by immediately entering a command.
- If you need help during operation, press **HELP/0**. The TAD announces the help messages.

When you finish operating the TAD, press **REMOTE** again so you can use the handset to make and receive calls.

SETTING THE NUMBER OF RINGS

Set the **RING TIME** switch on the side of the base to select how long the TAD waits before it answers a call (two rings, five rings, or toll-saver).

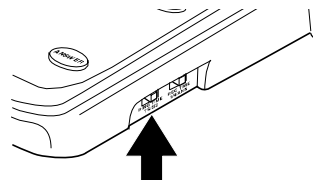

Note: If you plan to check your messages by long distance, set the number of rings to toll-saver (see "Using the Toll-Saver" on Page 26).

SETTING THE REMOTE OPERATION PIN

The PIN (personal identification number) permits remote access to the TAD. The PIN can be any number from 00 to 99.

Note: The default setting is 00.

1. Press **REMOTE** on the handset so the BATT LOW indicator lights green.

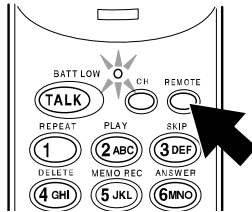

2. Press **PIN/#** on the keypad, then enter your two-digit PIN.

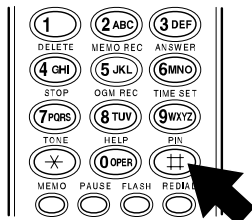

3. Press **PIN/#** on the keypad again. A beep sounds and your PIN is stored.

Note: If you make an error, the TAD beeps 5 times. Repeat the steps to enter the number correctly.

SETTING THE DAY AND TIME

You must set the day and time so the TAD can record the correct day and time of each message.

1. Press **REMOTE** on the handset so the BATT LOW indicator lights green.
2. Press **TIME SET/9** on the keypad. Then enter the day of the week using the number keys.

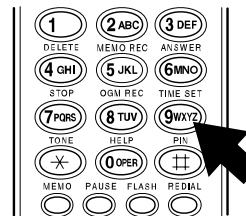

To Enter:	Press:
Sunday	1
Monday	2
Tuesday	3
Wednesday	4
Thursday	5
Friday	6
Saturday	7

3. Using the number keys, enter the hour. Precede a single-digit hour with a zero.
4. Using the number keys, enter the minutes. Precede a single-digit minute with a zero.

5. Press ✕ for AM or # for PM. The TAD beeps, then announces the time you set through the handset, and beeps again.

Notes:

- The seconds start to count from 00 after you set AM or PM.
- If you make an error, the TAD beeps 5 times. Repeat the steps to enter the day and time correctly.

SELECTING AN OUTGOING MESSAGE

The TAD has two pre-recorded messages. One asks the caller to leave a message (“Hello, no one is available to take your call. Please leave your message after the tone.”); the other is simply an announcement and does not let the caller leave a message (“Hello, no one is available to take your call.”). You can also record your own message (see “Recording an Outgoing Message”).

Use the **REC TIME** switch to select which message you want. When you set it to either **1** or **4** (minutes), the normal message is selected and the TAD records each incoming message for 1 or 4 minutes. When you set it to **ANN**, the announce-only message is selected.

Recording an Outgoing Message

You can record your own message up to 1 minute long for the caller to hear when the TAD answers a call. Use the handset to record the message.

If you record an outgoing message, the TAD plays it instead of either of the pre-recorded messages. Depending on the **REC TIME** switch setting, either tell callers to leave a message or state your message as an announcement only.

Hint: Do not tell callers that you are not home. Instead, say that you cannot come to the phone right now.

Follow these steps to record your outgoing message.

1. Press **REMOTE** on the handset so the BATT LOW indicator lights green.
2. Hold down **OGM REC/8** for about 2 seconds until the TAD beeps. Then speak your outgoing message into the handset.



3. When you finish your message, press **STOP/7**. The TAD beeps, plays back the message, then beeps again.

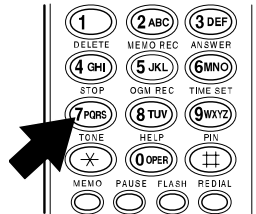

outgoing message (either a pre-recorded message or your personal message), press **ANSWER/6**.

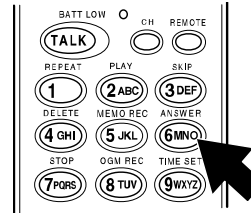

Note: If your message is less than 2 seconds, the TAD does not recognize it as a new message, and plays back the previous pre-recorded message. Re-record your message and make sure it is longer than 2 seconds.

To delete your personal message and use the pre-recorded messages again, hold down **OGM REC/8** for about 2 seconds until the TAD beeps. Then, within 2 seconds, press **STOP/7**.

Notes:

- If the incoming message memory capacity has less than 5 minutes left, the TAD announces “Remaining time, xx minute(s)” when you set the TAD to answer calls.
- If the incoming message memory capacity is full (40 messages or less than 1 minute left), the TAD announces “No remaining time for incoming messages” and does not answer calls.

SETTING THE TAD TO ANSWER CALLS

To set the TAD to answer calls, press **ANSWER** on the base. The number of currently recorded messages appears on the display if you set the TAD to announce and record, or **A** appears if you set it to announce only.

You can also turn the TAD on and off from the handset. Press **REMOTE** so the BATT LOW indicator lights green. When the TAD announces the current

To turn off the TAD, press **ANSWER/6** on the handset or **ANSWER** on the base.

SCREENING CALLS

You can let the TAD answer calls for you while you listen to the caller's message through the base's speaker. If you decide to answer the call while screening, lift the handset or press **TALK**. The TAD stops recording and resets to answer the next call.

You can also use the handset to screen calls. When the TAD starts to answer a call, press **REMOTE** on the handset and listen to the caller's message. If you decide to answer the call, press **TALK**. If you decide to hang up and let the TAD record the caller's message, press **REMOTE** again.

- When you finish recording your memo, press **STOP/7**. The TAD beeps again.

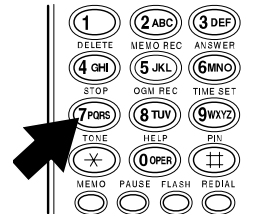

The memo must be at least 2 seconds long to be recorded. If it is less than 2 seconds long, an error beep sounds.

The memo is counted as one message. To listen to the recorded memo, see "Playing Messages."

RECORDING A MEMO

You can leave a message (memo) up to 4 minutes long, for yourself or others, using the handset.

- Press **REMOTE** on the handset so the BATT LOW indicator lights green.
- Press **MEMO REC/5**.

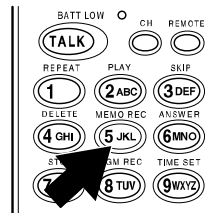

- When the TAD beeps, speak into the handset.

PLAYING MESSAGES

After a new message is recorded, the TAD beeps about every 8 seconds (if **RINGER** is set to **ON**), and the number of all recorded messages flashes on the display.

Notes:

- The maximum number of messages that the display can show is 19. The number does not change even if you have received more messages.
- When the TAD receives 40 messages or the memory capacity has less than 1 minute left, **F** (full) flashes on the display.

- If you turn the base's ringer off, the TAD does not beep when it receives new messages. See "Turning the Base's Ringer Off/On" on Page 14.

Press **PLAY/SKIP** on the base, or press **REMOTE** then **PLAY/2** on the handset. The TAD announces the number of messages and whether the messages are old (already listened to) or new. Then each new message plays, followed by the day and time it was recorded.

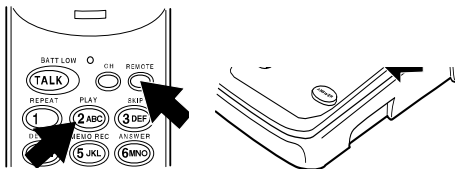

When you have both old and new messages, the TAD first plays back only new messages. After you have listened to the new messages, you can listen to all messages (old then new) by pressing **PLAY** again.

While playing back the messages, the display shows the number of the current message. For example, if you have a total of four messages (one old, three new), pressing **PLAY** displays **2** (the first new message).

If there are no messages when you press **PLAY**, five beeps sound and the TAD announces "You have no messages."

Notes:

- If the TAD detects a busy signal or silence for more than 7 seconds while recording a message, it stops recording and releases the call.
- When you play back messages using the handset, the message number does not appear on the display.

To skip to the next message, press **PLAY/SKIP** (or **SKIP/3** on the handset).

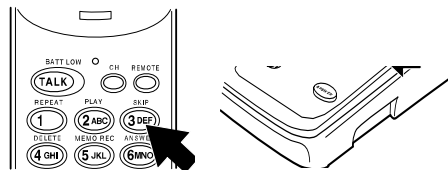

To play the current message again, press **REPEAT** (or **REPEAT/1** on the handset).

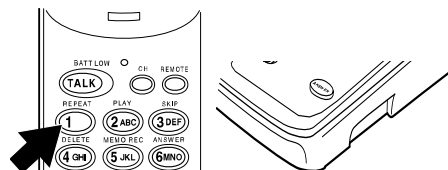

Note: If you press **REPEAT** within 2 seconds after a message begins playing, the TAD repeats the previous message.

After all messages and memos have played, the TAD says "End of messages." To stop playback before the end of the messages, press **STOP** (or **STOP/7** on the handset).

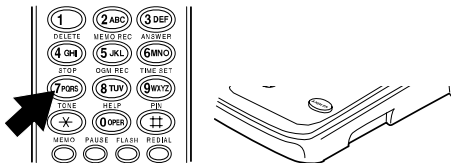

ADJUSTING THE TAD'S VOLUME

You can adjust the playback volume by repeatedly pressing **VOLUME** s/t on the base during message playback or call screening. The current volume setting appears on the display.

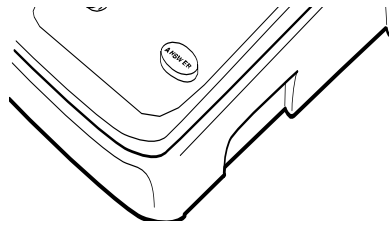

DELETING MESSAGES

To delete the current message, press **DELETE** (or **DELETE/4** on the handset) at any time during message playback.

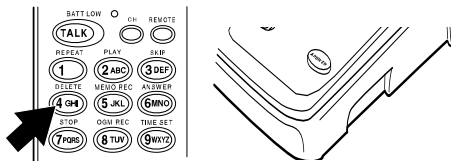

Volume settings are from 1 to 15, soft to loud. When you set the volume level to 1, the TAD is silent while it is answering the call.

To delete all messages at once, while messages are not playing, hold down **DELETE** on the base until the TAD beeps and 0 appears on the display.

Note: If the TAD has any new messages that have not been played, it sounds 5 beeps and does not delete messages.

REMOTE OPERATION

USING THE TOLL-SAVER

When you call the TAD with **RING TIME** set to **TS** (toll-saver), it answers after about two rings if you have new messages (ones you have not listened to). If there are no new messages, the TAD waits for about five rings before it answers. This gives you time to hang up before the TAD answers so you can avoid any long-distance charges.

ACCESSING THE TAD BY REMOTE

While you are away from the phone's base, you can use a touch-tone phone or a pulse (rotary) phone with a pocket tone dialer to enter your PIN and do any of the following:

- Set the TAD to answer calls
- Listen to your messages
- Record a new announcement
- Record a memo
- Erase messages
- Turn the TAD off

Note: You cannot access the TAD from another telephone on the same line as your TAD-1015.

1. Dial your phone number and wait for the TAD to answer.

If the TAD is not set to answer calls, let the phone ring 10 times. The TAD automatically turns itself on to answer your call then turns

off when you hang up (unless you set the TAD to answer calls).

2. When the outgoing message begins, press # then enter your 2-digit PIN within 2 seconds.

The message stops, and the TAD announces "You have XX new message(s)" or "You have no messages," then plays a series of voice prompts to guide you through remote operation.

3. Press #, then, within 2 seconds, press the number key for the command you want.

Press:	To:
# 1	Repeat current message.
# 2	Play messages and memos.
# 3	Skip current message during playback.
# 4	Delete current message during playback.
# 5	Record a memo.
# 6	Set the TAD to answer/not answer calls.
# 7	Stop playback of messages, memos, or the outgoing announcement; end recording of memo and outgoing announcement.
# 8	Record a new outgoing message.
# 0	Play the voice prompts again.

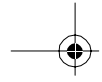

Notes:

- You can enter the command while the TAD is announcing the number of messages or during the voice prompts.
- If you do not enter a command within 20 seconds after the voice prompts end, the TAD hangs up.

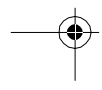
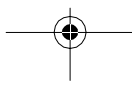
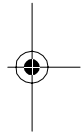
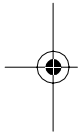

TROUBLESHOOTING

We do not expect you to have any problems with your TAD-1015, but if you do, try these suggestions. If you still have problems, take your TAD-1015 to your local RadioShack store for assistance.

Problem	Suggestion
Noise, static, or weak signal when the phone is away from the base.	Move the handset closer to the base or relocate the base.
Noise, static, or weak signal even when the phone is near the base.	Press CH to change the channel (see "Changing the Channel" on Page 15).
	Make sure the base's antenna is fully extended.
The TAD does not answer calls.	Check all phone line connections.
	Make sure the AC adapter and battery are properly connected.
	Make sure the TAD is turned on.
The TAD does not record callers' messages.	Check the available memory and erase messages as required.
	The TAD is set to announcement only. Set REC TIME to 1 or 4.
The handset does not ring when you receive a call.	Check all phone line connections.
	Make sure the AC adapter and battery are properly connected.
	Unplug some of the other phones on the telephone line.
The caller's voice fades in and out.	Move the handset closer to the base or relocate the base.
You hear other calls while using your phone.	Press CH to change the channel (see "Changing the Channel" on Page 15).
	Try another phone connected to the same line. If you still hear other calls, the problem is probably in your wiring or local service. Contact your local telephone company.



Problem	Suggestion
You hear noise in the handset, and none of the keys work.	Make sure the AC adapter and battery are properly connected.
	Press CH to change the channel (see "Changing the Channel" on Page 15).
There is no dial tone.	Check all phone line connections.
	Make sure the AC adapter and battery are properly connected.
	Make sure the batteries are properly charged.

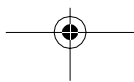

CARE AND MAINTENANCE

Your RadioShack TAD-1015 25-Channel Cordless Telephone High-Capacity Digital Answering System is an example of superior design and craftsmanship. The following suggestions will help you care for your TAD-1015 so you can enjoy it for years.



Keep the TAD-1015 dry. If it gets wet, wipe it dry immediately. Liquids might contain minerals that can corrode the electronic circuits.



Use and store the TAD-1015 only in normal temperature environments. Temperature extremes can shorten the life of electronic devices, (damage batteries,) and distort or melt plastic parts.



Keep the TAD-1015 away from dust and dirt, which can cause premature wear of parts.



Handle the TAD-1015 gently and carefully. Dropping it can damage circuit boards and cases and can cause the TAD-1015 to work improperly.



Wipe the TAD-1015 with a damp cloth occasionally to keep it looking new. Do not use harsh chemicals, cleaning solvents, or strong detergents to clean the TAD-1015.

Modifying or tampering with the TAD-1015's internal components can cause a malfunction and might invalidate its warranty and void your FCC authorization to operate it. If your TAD-1015 is not performing as it should, take it to your local RadioShack store for assistance. If the trouble is affecting the phone lines, the phone company can ask you to disconnect the phone until you have resolved the problem.

REPLACING THE BATTERY PACK

If you follow the instructions in "Connecting and Charging the Battery Pack" on Page 12, the battery pack should last about one year. If the battery does not hold a charge for more than 2 hours after an overnight charge, replace the battery pack with a 3.6 volt, 300 mA battery pack with a connector that fits the socket in the battery compartment. You can order a replacement through your local RadioShack store.

Install the new battery pack as follows, then charge the battery for about 18 hours (see "Connecting and Charging the Battery Pack" on Page 12).

Notes:

- If you have trouble replacing the battery pack, take the phone to your local RadioShack store for assistance.
- To avoid losing phone numbers stored in memory, install and begin charging the new battery pack within 3 minutes.

1. Remove the screw on the battery compartment cover on the bottom of the handset, and slide off the cover in the direction of the arrow.

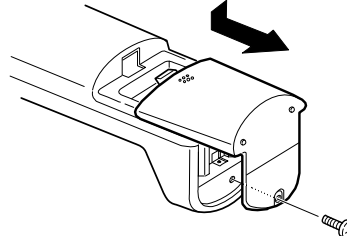

2. Gently pull on the battery connector to disconnect it from the socket, then remove the battery.
3. Plug the new battery pack's plastic connector into the socket and place the battery pack into the compartment.
4. Replace the cover and tighten the screw.

Cautions:

- You must use a replacement battery pack of the same size and type.
- Do not burn or bury a battery pack.
- Be careful not to short the battery pack by touching it with conducting materials, such as rings, bracelets, and keys. The battery or conductor might overheat and burn.

Important: This product contains a rechargeable nickel cadmium battery. At the end of the battery's useful life, it must be recycled or disposed of properly. Contact your local, county, or state hazardous waste management authorities for information on recycling or disposal programs in your area. Some options that might be available are: municipal curb-side collection, drop-off boxes at retailers such as your local RadioShack store, recycling collection centers, and mail-back programs.

THE FCC WANTS YOU TO KNOW

In the unlikely event that your phone causes problems on the phone line, the phone company can temporarily discontinue your service. The phone company normally attempts to notify you in advance. If advance notice is not practical, the phone company notifies you as soon as possible and advises you of your right to file a complaint with the FCC.

Also, the phone company can make changes to its lines, equipment, operations, or procedures that could affect the operation of this telephone. The phone company normally notifies you of these changes in advance, so you can take the necessary steps to prevent interruption of your phone service.

Your phone might cause TV or radio interference even when it is operating properly. To determine whether your phone is causing the interference, turn off and unplug your phone and disconnect the handset battery. If the interference goes away, your phone is causing it.

Try to eliminate the interference by:

- Moving your phone away from the receiver
- Connecting your phone to an AC outlet that is on a different electrical circuit from the receiver
- Contacting your local RadioShack store for help

Some cordless telephones operate on frequencies that may cause interference to nearby TVs and VCRs. To minimize or prevent such interference, the base of the cordless telephone should not be placed near or on top of TVs or VCRs. If interference is experienced, moving the cordless telephone farther away from the TV or VCR will often reduce or eliminate the interference.



LIGHTNING

Your TAD-1015 has built-in lightning protection to reduce the risk of damage from surges in phone and power line current. This protection meets or exceeds FCC requirements. However, lightning striking the phone line or power lines can damage your phone.

Lightning damage is not common. Nevertheless, if you live in an area that has severe electrical storms, we suggest that you unplug your phone during storms to reduce the possibility of damage.

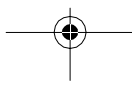
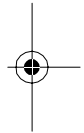
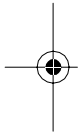



NOTES

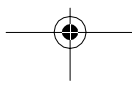
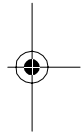

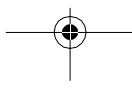
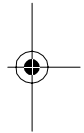



Limited One-Year Warranty

This product is warranted by RadioShack against manufacturing defects in material and workmanship under normal use for one (1) year from the date of purchase from RadioShack company-owned stores and authorized RadioShack franchisees and dealers. EXCEPT AS PROVIDED HEREIN, RadioShack MAKES NO EXPRESS WARRANTIES AND ANY IMPLIED WARRANTIES, INCLUDING THOSE OF MERCHANTABILITY AND FITNESS FOR A PARTICULAR PURPOSE, ARE LIMITED IN DURATION TO THE DURATION OF THE WRITTEN LIMITED WARRANTIES CONTAINED HEREIN. EXCEPT AS PROVIDED HEREIN, RadioShack SHALL HAVE NO LIABILITY OR RESPONSIBILITY TO CUSTOMER OR ANY OTHER PERSON OR ENTITY WITH RESPECT TO ANY LIABILITY, LOSS OR DAMAGE CAUSED DIRECTLY OR INDIRECTLY BY USE OR PERFORMANCE OF THE PRODUCT OR ARISING OUT OF ANY BREACH OF THIS WARRANTY, INCLUDING, BUT NOT LIMITED TO, ANY DAMAGES RESULTING FROM INCONVENIENCE, LOSS OF TIME, DATA, PROPERTY, REVENUE, OR PROFIT OR ANY INDIRECT, SPECIAL, INCIDENTAL, OR CONSEQUENTIAL DAMAGES, EVEN IF RadioShack HAS BEEN ADVISED OF THE POSSIBILITY OF SUCH DAMAGES.

Some states do not allow the limitations on how long an implied warranty lasts or the exclusion of incidental or consequential damages, so the above limitations or exclusions may not apply to you.

In the event of a product defect during the warranty period, take the product and the RadioShack sales receipt as proof of purchase date to any RadioShack store. RadioShack will, at its option, unless otherwise provided by law: (a) correct the defect by product repair without charge for parts and labor; (b) replace the product with one of the same or similar design; or (c) refund the purchase price. All replaced parts and products, and products on which a refund is made, become the property of RadioShack. New or reconditioned parts and products may be used in the performance of warranty service. Repaired or replaced parts and products are warranted for the remainder of the original warranty period. You will be charged for repair or replacement of the product made after the expiration of the warranty period.

This warranty does not cover: (a) damage or failure caused by or attributable to acts of God, abuse, accident, misuse, improper or abnormal usage, failure to follow instructions, improper installation or maintenance, alteration, lightning or other incidence of excess voltage or current; (b) any repairs other than those provided by a RadioShack Authorized Service Facility; (c) consumables such as fuses or batteries; (d) cosmetic damage; (e) transportation, shipping or insurance costs; or (f) costs of product removal, installation, set-up service adjustment or reinstallation.

This warranty gives you specific legal rights, and you may also have other rights which vary from state to state.

RadioShack Customer Relations, Dept. W, 100 Throckmorton St., Suite 600, Fort Worth, TX 76102

We Service What We Sell

3/97



RadioShack
A Division of Tandy Corporation
Fort Worth, Texas 76102

UDZZ01505ZB
Printed in the Philippines

9A7

