

Cat. No. 43-696A
OWNER'S MANUAL

Please read before using this equipment.

ET-596

25-Channel 2-Line Cordless Telephone with 3-Way Conference Calling

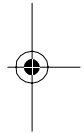
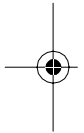

RadioShack®

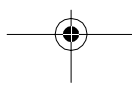

FEATURES

Your RadioShack ET-596 25-Channel 2-Line Cordless Telephone with 3-Way Conference Calling lets you place and receive calls on two separate telephone lines. It is designed to exacting standards that ensure reliability, long life, and outstanding performance.

Its features include:

Two-Line Telephone System — lets you easily handle two telephone lines at the same time. You can also make 3-way conference calls.

25 Channels — lets you change to another channel during a call to reduce interference.

10-Number Memory Dialing — lets you store up to 10 numbers in memory for easy dialing.

Super CCT Noise-Reduction Circuitry — gives you sound clarity comparable to corded telephones.

Security Access-Protection Code — prevents other cordless phone users from using your phone line while the handset is off the base.

COM-LOK® — ensures that other cordless phone users cannot use your phone line when the handset is on the base.

Redial — lets you quickly redial the last number dialed.

Page — sends a signal from the base to the handset so you can page someone or locate the handset if you have misplaced it.

Flash — sends an electronic switch-hook signal so you can use the phone with special phone services, such as Call Waiting.

Tone/Pulse Dialing — lets you use your phone with either type of service.

Quick Talk — lets you quickly make or answer a call by simply lifting the handset from the base.

Hearing-Aid Compatibility — lets you use your phone with hearing aids that have a T (telephone) switch.

This telephone has been tested and found to comply with all applicable UL and FCC standards.

We recommend you record your phone's serial number here. The number is on the bottom panel of the base.

Serial Number: _____



© 1996 Tandy Corporation.
All Rights Reserved.

COM-LOK and RadioShack are registered trademarks used by Tandy Corporation.

Important Note: Cordless phones such as your ET-596 require AC power to operate. When the AC power is off, you cannot dial out or receive incoming calls using this phone. To be safe, you should also have a phone that does not need AC power to operate (not a cordless phone) so you can still make and receive calls if there is an AC power failure

Your telephone operates on standard radio frequencies as allocated by the FCC. Even though the access protection code prevents unauthorized use of your phone line, it is possible for other radio units operating on similar frequencies within a certain area to unintentionally intercept your conversations and/or cause interference. This lack of privacy can occur with any cordless phone.

Warning: To prevent fire or shock hazard, do not expose this phone to rain or moisture.

	CAUTION RISK OF ELECTRIC SHOCK. DO NOT OPEN.	
CAUTION: TO REDUCE THE RISK OF ELECTRIC SHOCK, DO NOT REMOVE COVER OR BACK. NO USER-SERVICEABLE PARTS INSIDE. REFER SERVICING TO QUALIFIED PERSONNEL.		



This symbol is intended to alert you to the presence of uninsulated dangerous voltage within the phone's enclosure that might be of sufficient magnitude to constitute a risk of electric shock. Do not open the phone's case.



This symbol is intended to inform you that important operating and maintenance instructions are included in the literature accompanying this phone.

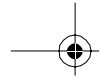

READ THIS BEFORE INSTALLATION

Each device that you connect to the phone line draws power from the phone line. We refer to this power draw as the device's Ringer Equivalence Number, or REN. The REN for your ET-596 is located on the bottom of the base.

If you are using more than one phone or other device on the line, add up all the RENs. If the total is more than five, your phones might not ring. In rural areas, a total REN of three might impair ringer operation. If ringer operation is impaired, remove a device from the line.

FCC STATEMENT

This telephone complies with Part 68 of *FCC Rules*. Upon request, you must provide the FCC Registration Number and the REN to your phone company. These numbers are located on the bottom of the base.

Note: You must not connect your phone to any of the following:

- coin-operated systems
- party-line systems
- most electronic key phone systems

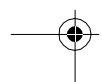
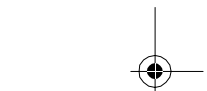
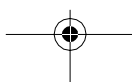
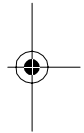
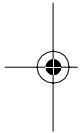

CONTENTS

Installation	6
Selecting a Location	6
Mounting/Connecting the Phone	6
Placing the Base on a Desk Top	7
Mounting the Base on a Wall Plate	8
Mounting the Base Directly on the Wall	10
Connecting and Charging the Battery	12
Setting the Dialing Mode	14
Operation	15
Making a Call	15
Answering a Call	15
Changing the Channel	15
Putting a Call on Hold	16
Making a Conference Call	16
Using Redial	17
Using Flash	17
Using Tone Services on a Pulse Line	18
Paging	18
Memory Dialing	18
Storing a Number In Memory	19
Entering a Pause	19
Dialing a Memory Number	20
Chain-Dialing Service Numbers	20
Testing Stored Emergency Numbers	20
Troubleshooting	21
Care and Maintenance	23
Replacing the Battery	24
The FCC Wants You to Know	25
Lightning	25

INSTALLATION

SELECTING A LOCATION

You can place the phone on a desk top or table, or mount it on a wall. Select a location that is:

- near an AC outlet
- near a telephone line jack
- out of the way of normal activities
- away from electrical machinery, electrical appliances, metal walls or filing cabinets, wireless intercoms, alarms, and room monitors
- away from other cordless phones

The base's location affects the handset's range. If you have a choice of several locations, try each to see which provides the best performance.

MOUNTING/CONNECTING THE PHONE

To use both of the ET-596's lines, you must connect it to two separate telephone lines. Each of these lines must have its own phone number. If you do not have two telephone lines, contact your phone company to get a second line.

You can connect your telephone to a 2-line modular telephone jack using the supplied 2-line modular cord.

Note: Two-line and single-line modular cords look alike, but are wired differently. To use the ET-596's two lines, use only the supplied 2-line modular cord to connect to a 2-line modular jack.

Or, you can connect your telephone to two separate 1-line modular telephone jacks using the supplied modular cord and another 1- or 2-line modular cord (such as RadioShack Cat. No. 279-356, not supplied).

Note: You can also use the ET-596 with a single 1-line modular jack.

If your phone wiring does not have a modular phone jack, you can:

- Update the wiring yourself, using jacks and adapters available at your local RadioShack store
- Have the phone company update the wiring for you

Note: The USOC number of the jack to be installed is RJ14C for a two-line baseboard jack or RJ14W for a two-line wall-plate jack.

Caution: The supplied RadioShack adapter was designed specifically for your ET-596. Use only the supplied adapter.

Placing the Base on a Desk Top

Follow these steps when you place the base on a desk, shelf, or table.

1. If you have a single 2-line modular jack, plug one end of the supplied modular cord into the **TEL LINE 1/2** jack.

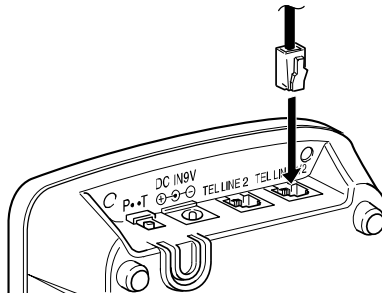

Note: When you make this connection, you should not connect another modular cord to the **TEL LINE 2** jack or phone operation will be erratic.

If you have two separate 1-line modular jacks, plug one end of the supplied modular cord into the **TEL LINE 1/2** jack and plug another modular cord (not supplied) into the **TEL LINE 2** jack.

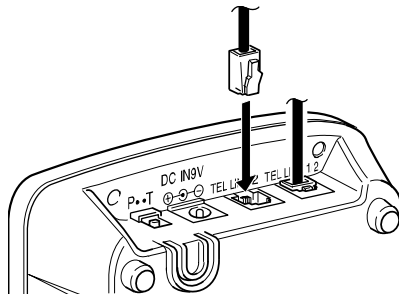

If you have only one 1-line modular jack, plug one end of the supplied modular cord into the **TEL LINE 1/2** jack to use line 1, or to the **TEL LINE 2** jack to use line 2.

2. Plug the supplied AC adapter's barrel plug into the **DC IN 9V** jack.

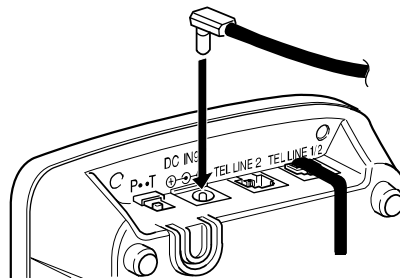

3. Route the adapter's cord through the strain relief slot.

Strain Relief Slot

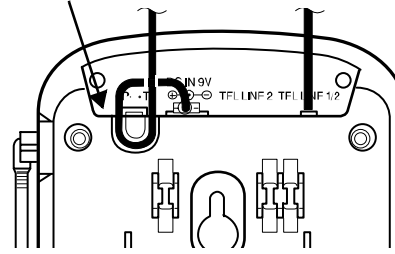

4. Plug the adapter into a standard AC outlet. The **POWER** indicator on the base lights.

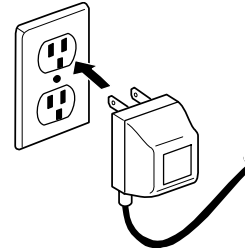

5. Plug the other end(s) of the modular cord(s) into the modular jack(s).

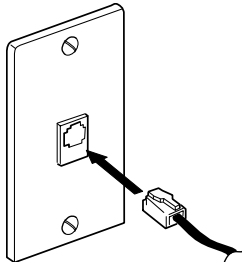

6. Raise the base's antenna to a vertical position and fully extend it.

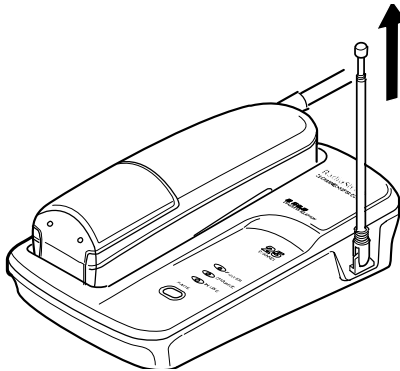

Mounting the Base on a Wall Plate

To make this connection, you need a 2-line short modular cord, such as Cat. No. 279-390, not supplied.

1. If you have a single 2-line modular jack on the wall plate, plug one end of a 2-line short modular cord into the **TEL LINE 1/2** jack.

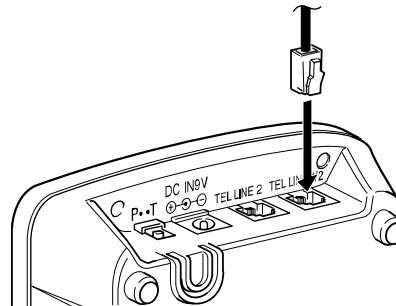

Note: When you make this connection, you should not connect another modular cord to the **TEL LINE 2** jack or phone operation will be erratic.

If you have a single 1-line modular jack on the wall plate and a modular wall jack close by, plug one end of a 2-line short modular cord into the **TEL LINE 1/2** jack to use line 1, then connect the supplied modular cord into the **TEL LINE 2** jack to use line 2.

If you have only one 1-line modular jack on the wall plate, plug one end of a 2-line short modular cord into the **TEL LINE 1/2** jack to use line 1, or to the **TEL LINE 2** jack to use line 2.

2. Plug the supplied AC adapter's barrel plug into the **DC IN 9V** jack.

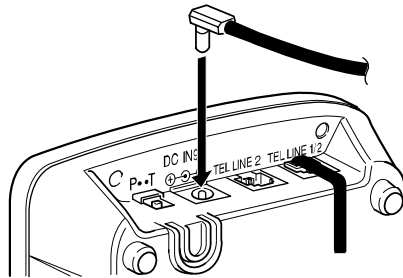

3. Route the adapter cord through both the upper and lower grooves and the modular cord(s) through only the upper groove on the bottom of the base.

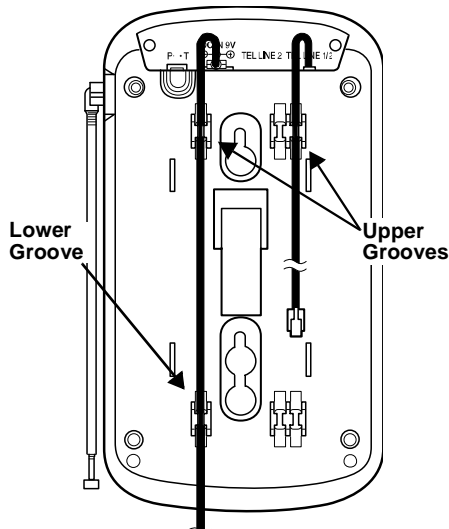

Note: If you are using two line cords, route both cords through the appropriate grooves.

4. Plug the adapter into a standard AC outlet. The **POWER** indicator on the base lights.

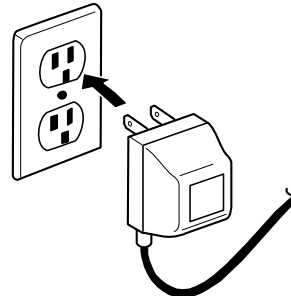

5. Plug the other end(s) of the modular cord(s) into the wall plate jack (and wall jack, if appropriate), then align the base's keyhole slots with the wall plate studs and slide the base downward to secure it.

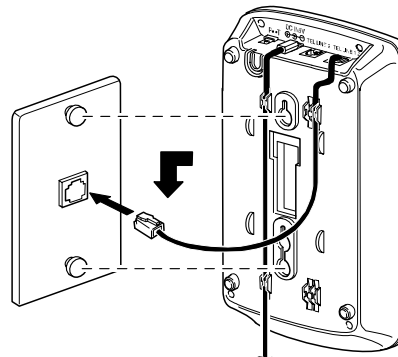

6. Press and lift out the handset holder, rotate it 180°, then snap it back into place so it holds the handset.

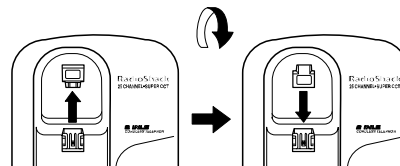

7. Raise the base's antenna to a vertical position and fully extend it.

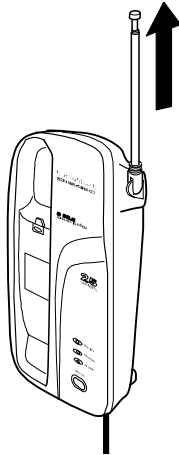

2. If you have a single 2-line modular jack close by, plug one end of the supplied modular cord into the **TEL LINE 1/2** jack.

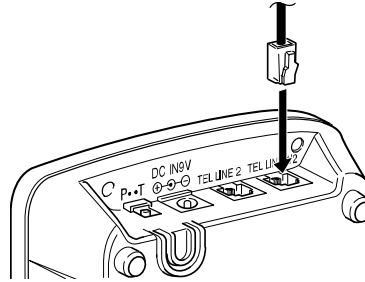

Note: When you make this connection, you should not connect another modular cord to the **TEL LINE 2** jack or phone operation will be erratic.

If you have two separate 1-line modular jacks, plug one end of the supplied modular cord into the **TEL LINE 1/2** jack and plug another modular cord (not supplied) into the **TEL LINE 2** jack.

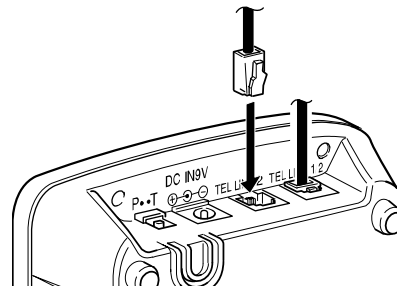

If you have only one 1-line modular jack, plug one end of the supplied modular cord into the **TEL LINE 1/2** jack to use line 1, or to the **TEL LINE 2** jack to use line 2.

Mounting the Base Directly on the Wall

To mount the base directly on the wall, you need two wood screws (not supplied) with heads that fit into the key-hole slots on the bottom of the base.

1. Drill two holes $3\frac{15}{16}$ inches apart. Then thread a screw into each hole, letting the heads extend about $\frac{5}{16}$ inch from the wall.

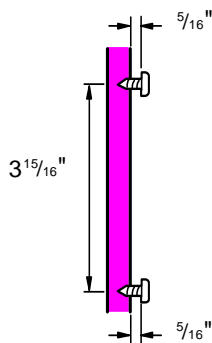

3. Plug the supplied AC adapter's barrel plug into the **DC IN 9V** jack.

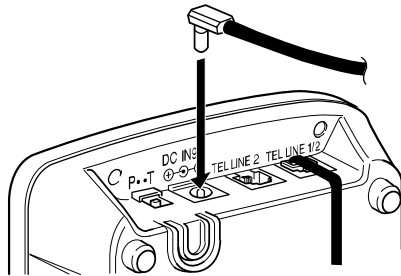

4. Route the adapter and modular cords through both the upper and lower grooves on the bottom of the base.

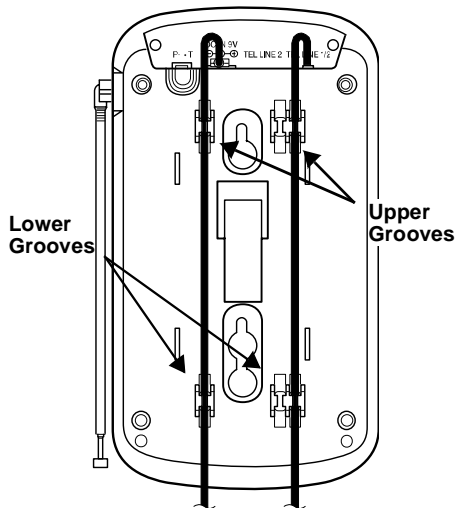

Note: If you are using two line cords, route both through the appropriate grooves.

5. Plug the adapter into a standard AC outlet. The **POWER** indicator on the base lights.

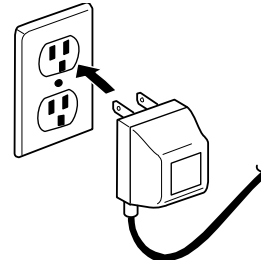

6. Plug the other end(s) of the cord(s) into a modular phone line jack(s).

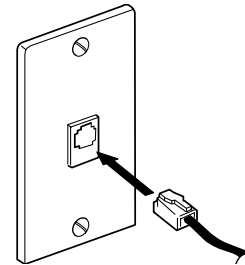

7. Align the keyhole slots with the mounting screws and slide the base downward to secure it.

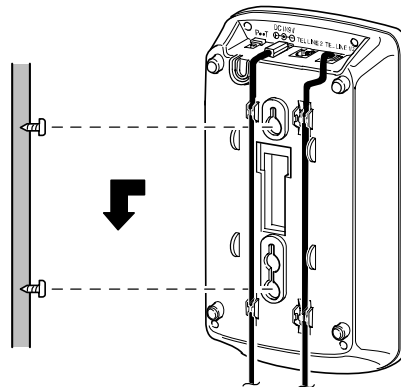

8. Press and lift out the handset holder, rotate it 180°, then snap it back into place so it holds the handset.

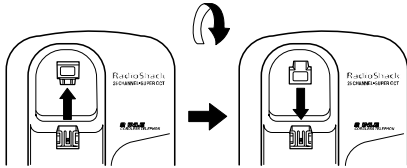

9. Raise the base's antenna to a vertical position and fully extend it.

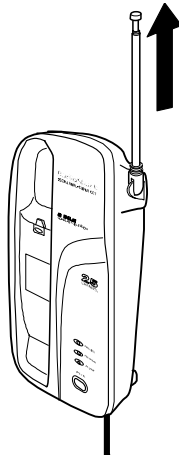

CONNECTING AND CHARGING THE BATTERY

The ET-596 comes with a rechargeable nickel-cadmium battery installed in the handset. Before using your phone, you must connect the battery then charge it for about 14 hours.

1. Remove the screw from the battery compartment cover on the bottom of the handset, then press down and slide off the handset's cover.

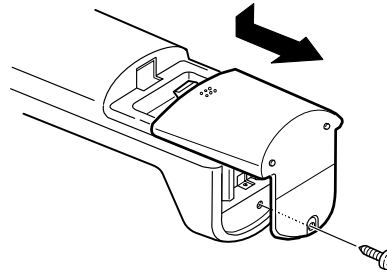

2. Plug the battery pack's plastic connector into the phone's socket. The connector fits only one way.

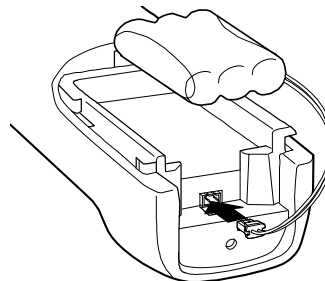

3. Replace the cover and tighten the screw.

- To charge the battery, simply place the handset on the base. The CHARGE indicator on the base lights.

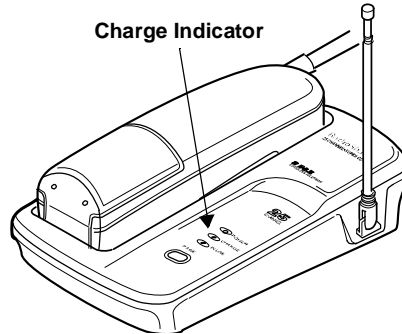

Recharge the battery when the BATT LOW indicator flashes.

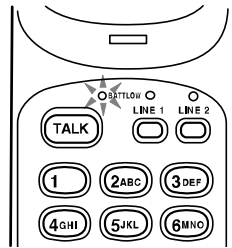

Notes:

- If the CHARGE indicator does not light when you place the handset on the base, be sure the battery and AC adapter are correctly and securely connected.
- When you first use the phone after charging or recharging the battery, the phone might not work and you might hear an error tone. If this happens, return the handset to the base for a few seconds.

- If the BATT LOW indicator does not light, but the phone does not work, recharge the battery. (The battery charge might be too low to light the indicator.)
- If the battery pack gets weak during a call, the handset sounds a beep every 30 seconds, and the BATT LOW indicator flashes. If this happens, you must recharge the battery before you can make another call.
- About once a month, fully discharge the battery by keeping the handset off the base until the BATT LOW indicator lights. Otherwise, the battery loses its ability to fully recharge.
- Using a pencil eraser, clean the charging contacts on the handset and the base about once a month to make sure they are not dirty or tarnished.

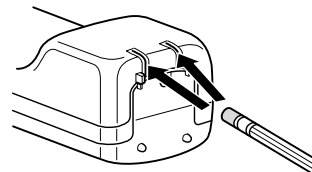
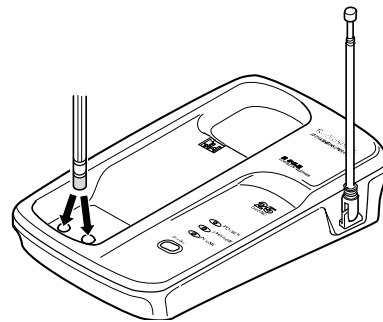

SETTING THE DIALING MODE

Set **P••T** on the back of the base for the type of service you have. If you are not sure which type you have, once the battery is charged, do this test.

1. Set **P••T** to **T** (tone).

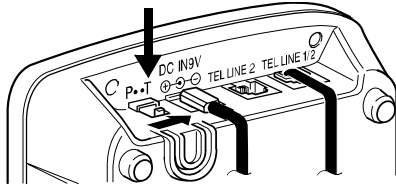

2. Lift the handset, press **LINE 1** and listen for the dial tone.
3. Press any number other than **0**.

Note: If your phone system requires that you dial an access code (**9**, for example) before you dial an outside number, do not press the access code either.

If the dial tone stops, that line has tone service.

If the dial tone continues, that line has pulse service.

4. Press **LINE 2**, listen for the dial tone, and repeat Step 3.

If you have tone service on both lines, leave **P••T** set to **T**.

If you have pulse service on either line, set **P••T** to **P**.

OPERATION

MAKING A CALL

To make a call, lift the handset. Or, if the handset is away from the base, press **TALK**. On the base, the IN USE indicator lights, and on the handset, the BATT LOW indicator and a LINE indicator (1 or 2, whichever line was dialed the last time) light.

You can also press **LINE 1** or **LINE 2** to directly select the line you want to use.

ANSWERING A CALL

To answer a call, simply lift the handset. If the handset is away from the base, press **TALK** to answer the flashing line. The TALK/BATT LOW indicator, the LINE 1 or LINE 2 indicator on the handset, and the IN USE indicator on the base light.

To help you tell which line is ringing, each line has a distinctive ring tone. To end a call, place the handset on the base or press the handset's **TALK** button.

Notes:

- If you press **TALK** to hang up and the phone does not disconnect, place the handset on the base or press **TALK** again while holding the handset closer to the base.
- When you receive an incoming call on one line while you are talking on the other, the handset does not ring but you hear the phone

sound a tone through the ear-piece. Place the current call on hold (see "Putting a Call on Hold" on Page 16), then press the line button for the new incoming call.

- If you press the other line's button without first pressing **HOLD**, the first call is disconnected.

CHANGING THE CHANNEL

If you notice interference, static, or noise during a call, you can press **CH** (channel) to find a clearer channel.

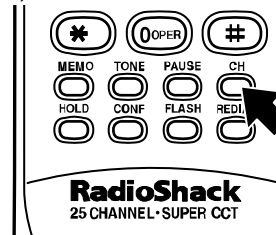

The ET-596 changes to a different channel each time you press **CH**.

Note: If the handset is too far away from the base, the channel might not change. Move closer to the base and try again.

PUTTING A CALL ON HOLD

Press **HOLD** to put a call on hold so you can temporarily place the handset on the base or use the other phone line without disconnecting the current call. The light over the line's button flashes when that call is on hold.

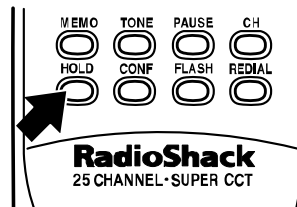

The phone disconnects the call 5 minutes after you put it on hold. However, during those 5 minutes, a series of beeps reminds you the call is on hold. After 1 minute, the handset beeps every 15 seconds. After 4 minutes, the handset beeps every 5 seconds. After 5 minutes, the handset sounds a long tone and disconnects the call.

To release a line from hold and continue your conversation, press that line's button. You can also release a call from hold by pressing **TALK** or picking up the handset from the base.

You can use another phone on the same line to pick up the call on hold, but the handset still shows that line on hold. After 5 minutes the line indicator turns off.

You can alternate between the two lines by pressing **HOLD** then the button for the desired line.

Notes:

- If you press the other line's button without first pressing **HOLD**, the first call is disconnected.
- If you place the second line on hold, the hold time restarts for the first line. Both lines automatically disconnect after 5 minutes.
- A call on hold does not automatically disconnect as long as you are talking on the second line. The hold time restarts when you hang up the second line.
- If you place both lines on hold and then press **TALK** or pick up the handset from the base, the line you dialed last is released from hold and the line you dialed first remains on hold.

MAKING A CONFERENCE CALL

Follow these steps to make a 3-way conference call.

1. Place the first call on hold.
2. Make or answer a call on the other line.

3. Press **CONF**. The TALK/BATT LOW indicator briefly flashes and remains steadily on, and you can talk with both parties.

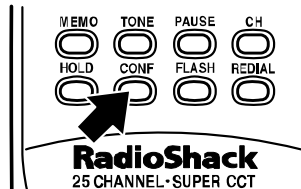

To end the conference call, press **TALK** or return the handset to the base. If you want to hang up one line and continue talking on the other, press the line button for the line you want to keep.

USING REDIAL

REDIAL lets you quickly dial the last number dialed on either LINE 1 or LINE 2. When you hear a dial tone, simply press **REDIAL**.

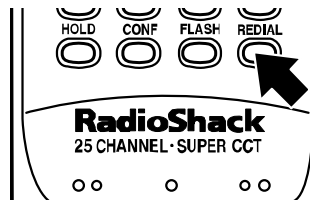

Notes:

- The redial memory holds up to 32 digits, so you can redial long-distance as well as local numbers.

- The redial memory also holds pause entries. See "Entering a Pause" on Page 19.
- The redial memory does not store a flash entry or any digits you press after **FLASH** (see "Using Flash").

USING FLASH

FLASH performs the electronic equivalent of a switchhook operation for special services, such as Call Waiting.

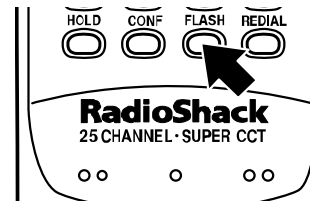

For example, if you have Call Waiting, press **FLASH** to answer an incoming call without disconnecting the current call. Press **FLASH** again to return to the first call.

Note: If you do not have any special phone services, pressing **FLASH** might disconnect the current call.

USING TONE SERVICES ON A PULSE LINE

Some special services, such as bank-by-phone, require tone signals. If you have pulse service, you can still use these special tone services by following these steps.

1. Be sure **P••T** is set to **P**.
2. Dial the service's main number.
3. When the service answers, press **TONE**. Any additional numbers you dial are sent as tone signals.

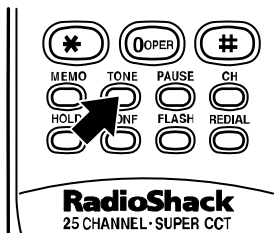

4. After you complete the call, return the handset to the base or press **TALK**. The phone automatically resets to the pulse mode.

PAGING

To page the person who has the handset or to locate the handset when the phone is not in use, press **PAGE** on the base. The handset beeps five times.

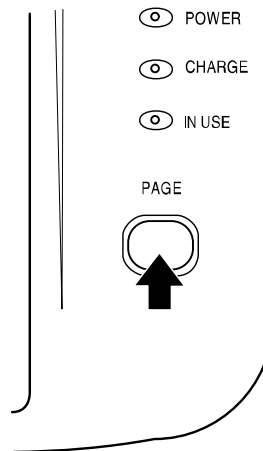

Note: Paging does not work during a call.

MEMORY DIALING

You can store up to 10 numbers in memory, then dial a stored number by pressing a one-digit memory location number.

Note: Each number you store can be up to 16 digits long.

Storing a Number in Memory

Note: If you wait more than 20 seconds between each key press, an error tone sounds and the phone exits the programming mode.

1. Lift the handset. If you hear a dial tone, press **TALK** to turn it off.
2. Press **MEMO**. The BATT LOW indicator blinks.

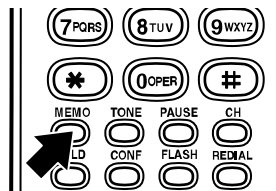

3. Enter the number and any **TONE** and **PAUSE** entries (see "Using Tone Services on a Pulse Line" on Page 18 and "Entering a Pause" on Page 19).

Note: Each **TONE** or **PAUSE** entry uses one digit of memory.

4. Press **MEMO**, then enter the memory location number (**0-9**). A single tone sounds to indicate that the number is stored.

If five quick beeps sound, you have made an entry error and the number was not stored. Start again from Step 2.

5. For each stored number, write the person's or company's name next to the appropriate location number on the supplied MEMORY directory sticker. (Use a pencil in case you want to change the number

later.) Attach the sticker to the phone.

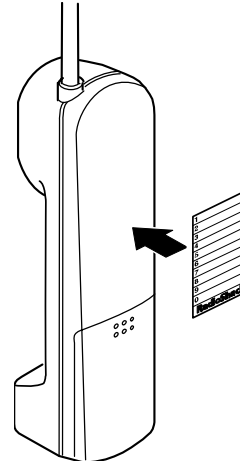

To erase a stored number, simply store a new number in its place. Or, skip Step 3, then press the memory location number (**0-9**) you want to clear. A tone sounds.

Entering a Pause

In some telephone systems, you must dial an access code (**9**, for example) and wait for a second dial tone before you can dial an outside number. You can store the access code with the phone number. However, you should also store a pause after the access code to allow the outside line time to connect.

To enter a 2-second pause, press **PAUSE**. For a longer pause, press **PAUSE** additional times.

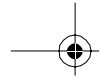

Dialing a Memory Number

To dial a number stored in memory, lift the handset from the base or press **TALK**.

When you hear a dial tone, press **MEMO** and enter the memory location number for the number you want to dial.

Chain-Dialing Service Numbers

When calling special services (such as alternate long distance or bank-by-phone), dial the service's main number first. Then, at the appropriate place in the call, press **MEMO** and the number for the memory location where the additional information is stored.

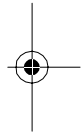
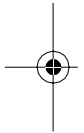

Testing Stored Emergency Numbers

If you store an emergency service's number (police department, fire department, ambulance) and you choose to test the stored number, make the test call during the late evening or early morning hours to avoid peak demand periods. Also, remain on the line to explain the reason for your call.

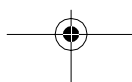

TROUBLESHOOTING

We do not expect you to have any problems with your phone, but if you do, the following suggestions might help.

Problem	Suggestion
Low volume or unusual sounds.	Someone has picked up another phone on the same line. Hang up the other phone.
Severe noise interference.	<ul style="list-style-type: none"> • Press CH to change the channel. • Keep the handset away from computers, remote control toys, wireless microphones, alarm systems, intercoms, room monitors, fluorescent lights, and electrical appliances. • Move to another location or turn off the source of interference.
The phone cannot be operated at a useful distance from the base because the signal becomes weak or noisy (handset's range has decreased).	<ul style="list-style-type: none"> • Fully extend the base's antenna in a vertical position. • Be sure neither antenna is touching a metal surface. • Return the handset to the base to recharge the battery.
The phone does not work or works poorly.	Be sure the base's phone line cord and AC adapter are correctly and securely connected, and the battery is connected and charged.
The handset battery does not charge.	<ul style="list-style-type: none"> • Check the charging contacts on the handset and base. If they are dirty, clean them with a pencil eraser. • Be sure the battery is connected correctly.

Problem	Suggestion
Handset does not ring or receive a page.	<ul style="list-style-type: none">• Return the handset to the base to recharge the battery pack.• Lift the base's antenna to a fully vertical position.• Move the handset closer to the base.• Move the base away from other electrical devices.
The handset stops working or works poorly during a call.	<ul style="list-style-type: none">• Move the handset closer to the base.• Fully extend the base's antenna, and place it in a vertical position.• Be sure the handset's battery is charged. (If the battery power is too low, it does not have enough power to light the BATT LOW indicator.)• If the base loses power while the handset is off of it, the security access-protection code might change. Restore power to the base, then place the handset back on the base. The CHARGE indicator lights, indicating that the code is set again.
The call is too noisy.	Change channels, or hang up and redial the number.

If you still have problems, disconnect the phone. If other phones on the same line work properly, the fault is in this phone or its installation. If you cannot find the problem, take your phone to your local RadioShack store for assistance.

CARE AND MAINTENANCE

Your RadioShack ET-596 25-Channel Two-Line Cordless Telephone with 3-Way Conference Calling is an example of superior design and craftsmanship. The following suggestions will help you care for your cordless telephone so you can enjoy it for years.



Keep the phone dry. If it gets wet, wipe it dry immediately. Liquids might contain minerals that can corrode the electronic circuits.



Use and store the phone only in normal temperature environments. Temperature extremes can shorten the life of electronic devices(, damage batteries,) and distort or melt plastic parts.



Keep the phone away from dust and dirt, which can cause premature wear of parts.



Handle the phone gently and carefully. Dropping it can damage circuit boards and cases and can cause the phone to work improperly.



Wipe the phone with a damp cloth occasionally to keep it looking new. Do not use harsh chemicals, cleaning solvents, or strong detergents to clean the phone.

Modifying or tampering with the telephone's internal components can cause a malfunction and might invalidate your telephone's warranty and void your FCC authorization to operate it. If your phone is not performing as it should, take it to your local RadioShack store for assistance. If the trouble is affecting the phone lines, the phone company might ask you to disconnect your phone until you have resolved the problem.

REPLACING THE BATTERY

If you follow the instructions in “Connecting and Charging the Battery” on Page 12, the battery should last about a year. If the battery will not hold a charge for more than 2 hours after an overnight charge, replace the battery with a new 3.6 V, 300 mA H battery with a connector that fits the socket in the battery compartment. You can order a replacement battery through your local RadioShack store.

Install the new battery as described below, then charge the battery for 24 hours before you use it.

Note: To avoid losing phone numbers stored in memory, try to install and begin charging the new battery within 1 minute after removing the old one.

1. Remove the screw from the battery compartment cover on the bottom of the handset, then press down and slide off the cover.

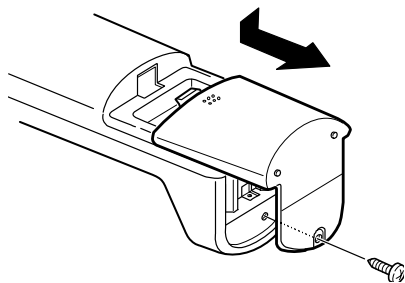

2. Gently pull on the battery connector to disconnect it, then remove the battery.
3. Insert a fresh battery and plug its connector into the socket inside the battery compartment.
4. Replace the cover and secure it with the screw.

Cautions:

- You must use a replacement battery of the same size and type.
- Do not dispose of the battery in a fire because it might explode.
- Do not open or mutilate the battery.
- Be careful not to short the battery by touching it with conducting materials, such as rings, bracelets, and keys. The battery or conductor might overheat and burn.

Important: This product contains a rechargeable nickel cadmium battery. At the end of the battery's useful life, it must be recycled or disposed of properly. Contact your local, county, or state hazardous waste management authorities for information on recycling or disposal programs in your area. Some options that might be available are: municipal curb-side collection, drop-off boxes at retailers such as your local RadioShack store, recycling collection centers, and mail-back programs.

THE FCC WANTS YOU TO KNOW

In the unlikely event that your phone causes problems on the phone line, the phone company can temporarily discontinue your service. If this happens, the phone company attempts to notify you in advance. If advance notice is not practical, the phone company notifies you as soon as possible and advises you of your right to file a complaint with the FCC.

Also, the phone company can make changes to its lines, equipment, operations, or procedures that could affect the operation of this telephone. The telephone company notifies you of these changes in advance, so you can take the necessary steps to prevent interruption of your telephone service.

Your phone might cause TV or radio interference even when it is operating properly. To determine whether your phone is causing the interference, turn off your phone. If the interference goes away, your phone is causing the interference.

Try to eliminate the interference by:

- Moving your phone away from the receiver
- Connecting your phone to an AC outlet that is on a different electrical circuit from the receiver
- Contacting your local RadioShack store for help

Some cordless phones operate at frequencies that might cause interference to nearby TVs and VCRs. To minimize or prevent such interference, the base of the cordless phone should not be placed near or on top of a TV or VCR.

LIGHTNING

Your telephone has built-in lightning protection to reduce the risk of damage from surges in telephone line and power line current. This lightning protection meets or exceeds FCC requirements. However, lightning striking the telephone or power lines can damage your telephone.

Lightning damage is not common. Nevertheless, if you live in an area that has severe electrical storms, we suggest that you unplug your phone during storms to reduce the possibility of damage.



NOTES

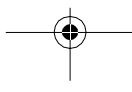
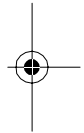
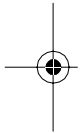

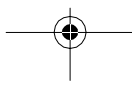
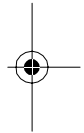
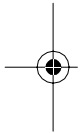

Limited One-Year Warranty

This product is warranted by RadioShack against manufacturing defects in material and workmanship under normal use for one (1) year from the date of purchase from RadioShack company-owned stores and authorized RadioShack franchisees and dealers. EXCEPT AS PROVIDED HEREIN, RadioShack MAKES NO EXPRESS WARRANTIES AND ANY IMPLIED WARRANTIES, INCLUDING THOSE OF MERCHANTABILITY AND FITNESS FOR A PARTICULAR PURPOSE, ARE LIMITED IN DURATION TO THE DURATION OF THE WRITTEN LIMITED WARRANTIES CONTAINED HEREIN. EXCEPT AS PROVIDED HEREIN, RadioShack SHALL HAVE NO LIABILITY OR RESPONSIBILITY TO CUSTOMER OR ANY OTHER PERSON OR ENTITY WITH RESPECT TO ANY LIABILITY, LOSS OR DAMAGE CAUSED DIRECTLY OR INDIRECTLY BY USE OR PERFORMANCE OF THE PRODUCT OR ARISING OUT OF ANY BREACH OF THIS WARRANTY, INCLUDING, BUT NOT LIMITED TO, ANY DAMAGES RESULTING FROM INCONVENIENCE, LOSS OF TIME, DATA, PROPERTY, REVENUE, OR PROFIT OR ANY INDIRECT, SPECIAL, INCIDENTAL, OR CONSEQUENTIAL DAMAGES, EVEN IF RadioShack HAS BEEN ADVISED OF THE POSSIBILITY OF SUCH DAMAGES.

Some states do not allow the limitations on how long an implied warranty lasts or the exclusion of incidental or consequential damages, so the above limitations or exclusions may not apply to you.

In the event of a product defect during the warranty period, take the product and the RadioShack sales receipt as proof of purchase date to any RadioShack store. RadioShack will, at its option, unless otherwise provided by law: (a) correct the defect by product repair without charge for parts and labor; (b) replace the product with one of the same or similar design; or (c) refund the purchase price. All replaced parts and products, and products on which a refund is made, become the property of RadioShack. New or reconditioned parts and products may be used in the performance of warranty service. Repaired or replaced parts and products are warranted for the remainder of the original warranty period. You will be charged for repair or replacement of the product made after the expiration of the warranty period.

This warranty does not cover: (a) damage or failure caused by or attributable to acts of God, abuse, accident, misuse, improper or abnormal usage, failure to follow instructions, improper installation or maintenance, alteration, lightning or other incidence of excess voltage or current; (b) any repairs other than those provided by a RadioShack Authorized Service Facility; (c) consumables such as fuses or batteries; (d) cosmetic damage; (e) transportation, shipping or insurance costs; or (f) costs of product removal, installation, set-up service adjustment or reinstallation.

This warranty gives you specific legal rights, and you may also have other rights which vary from state to state.

RadioShack Customer Relations, Dept. W, 100 Throckmorton St., Suite 600, Fort Worth, TX 76102

We Service What We Sell

3/97

RadioShack
A Division of Tandy Corporation
Fort Worth, Texas 76102

UDZZ01502ZA
Printed in the Philippines

10A7