

2-9925



**900MHz Two-Line
Cordless Telephone
User's Guide**



We bring good things to life.

FCC REGISTRATION INFORMATION

Your GE telephone equipment is registered with the Federal Communications Commission and is in compliance with parts 15 and 68, FCC Rules and Regulations.

1 Notification to the Local Telephone Company

On the bottom of this equipment is a label indicating, among other information, the FCC Registration number and Ringer Equivalence Number (REN) for the equipment. You must, upon request, provide this information to your telephone company.

The REN is useful in determining the number of devices you may connect to your telephone line and still have all of these devices ring when your telephone number is called. In most (but not all) areas, the sum of the RENs of all devices connected to one line should not exceed 5. To be certain of the number of devices you may connect to your line as determined by the REN, you should contact your local telephone company.

Notes

- This equipment may not be used on coin service provided by the telephone company.
- Party lines are subject to state tariffs, and therefore, you may not be able to use your own telephone equipment if you are on a party line. Check with your local telephone company.
- Notice must be given to the telephone company upon permanent disconnection of your telephone from your line.

2 Rights of the Telephone Company

Should your equipment cause trouble on your line which may harm the telephone network, the telephone company shall, where practicable, notify you that temporary discontinuance of service may be required. Where prior notice is not practicable and the circumstances warrant such action, the telephone company may temporarily discontinue service immediately. In case of such temporary discontinuance, the telephone company must: (1) promptly notify you of such temporary discontinuance; (2) afford you the opportunity to correct the situation; and (3) inform you of your right to bring a complaint to the Commission pursuant to procedures set forth in Subpart E of Part 68, FCC Rules and Regulations.

The telephone company may make changes in its communications facilities, equipment, operations or procedures where such action is required in the operation of its business and not inconsistent with FCC Rules and Regulations. If these changes are expected to affect the use or performance of your telephone equipment, the telephone company must give you adequate notice, in writing, to allow you to maintain uninterrupted service.

INTERFERENCE INFORMATION

This device complies with Part 15 of the FCC Rules. Operation is subject to the following two conditions: (1) This device may not cause harmful interference; and (2) This device must accept any interference received, including interference that may cause undesired operation.

This equipment has been tested and found to comply with the limits for a Class B digital device, pursuant to Part 15 of the FCC Rules. These limits are designed to provide reasonable protection against harmful interference in a residential installation.

This equipment generates, uses, and can radiate radio frequency energy and, if not installed and used in accordance with the instructions, may cause harmful interference to radio communications. However, there is no guarantee that interference will not occur in a particular installation.

If this equipment does cause harmful interference to radio or television reception, which can be determined by turning the equipment off and on, the user is encouraged to try to correct the interference by one or more of the following measures:

- Reorient or relocate the receiving antenna (that is, the antenna for radio or television that is "receiving" the interference).
- Reorient or relocate and increase the separation between the telecommunications equipment and receiving antenna.
- Connect the telecommunications equipment into an outlet on a circuit different from that to which the receiving antenna is connected.
- Consult the dealer or an experienced radio/TV technician for help.

If these measures do not eliminate the interference, please consult your dealer or an experienced radio/television technician for additional suggestions. Also, the Federal Communications Commission has prepared a helpful booklet, "How To Identify and Resolve Radio/TV Interference Problems." This booklet is available from the U.S. Government Printing Office, Washington, D.C. 20402. Please specify stock number 004-000-00345-4 when ordering copies.

HEARING AID COMPATIBILITY

This telephone system meets FCC standards for Hearing Aid Compatibility.

FCC NUMBER IS LOCATED ON THE CABINET BOTTOM REN NUMBER IS LOCATED ON THE CABINET BOTTOM
--

INTRODUCTION

Your GE 900 MHz Cordless Telephone is designed to give you flexibility in use and high quality performance. To get the most from your new cordless telephone, we suggest that you take a few minutes right now to read through this instruction manual.

TABLE OF CONTENTS

GETTING STARTED	2	ADVANCED FEATURES	13
BEFORE YOU BEGIN	2	CHANNEL BUTTON (CHAN)	13
MODULAR JACK REQUIREMENTS	2	THE MEMORY FEATURE	13
INSTALLATION OPTIONS	3	STORING A NUMBER IN MEMORY ...	13
DESKTOP INSTALLATION	4	CHANGING A STORED NUMBER	14
WALL MOUNT INSTALLATION	6	STORING A REDIAL NUMBER	14
CORDLESS PHONE BASICS	8	STORING A PAUSE IN MEMORY	14
MAKING A CALL	8	DIALING A STORED NUMBER	15
LINE INDICATOR LIGHTS	8	CHAIN DIALING FROM MEMORY	15
DUAL RINGER TONES	9	CONNECTING A HEADSET	
REDIAL(RE/PA)	9	TO THE HANDSET	16
RECEIVING A CALL	9	CONNECTING THE BELT CLIP	17
FLASH BUTTON	9	CHANGING THE BATTERY	18
VOLUME	10	BATTERY SAFETY PRECAUTIONS	18
RING/PWR (RINGER AND POWER)		TROUBLESHOOTING GUIDE	19
SWITCH	10	CAUSES OF POOR RECEPTION	21
MUTE BUTTON	11	GENERAL PRODUCT CARE	21
TEMPORARY TONE	11	SERVICE	22
HOLD BUTTON	12	ACCESSORY ORDER FORM	23
CONFERENCE BUTTON	12	INDEX	25
PAGING THE HANDSET	12	LIMITED WARRANTY	26

WARNING: TO PREVENT FIRE OR ELECTRICAL SHOCK HAZARD, DO NOT EXPOSE THIS PRODUCT TO RAIN OR MOISTURE.

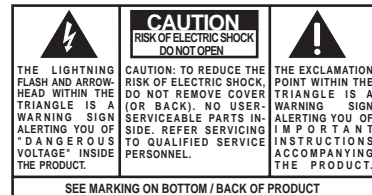

GETTING STARTED

Make sure your package includes the items shown here.

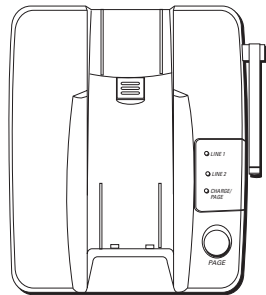

Base

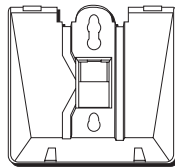

Base plate



Handset



Two telephone line cords



Short telephone line cord

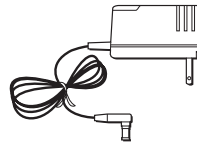

AC power adapter

BEFORE YOU BEGIN

MODULAR JACK REQUIREMENTS

You need an RJ11 type modular jack, which is the most common type of phone jack and might look like the one pictured here. If you don't have a modular jack, call your local phone company to find out how to get one installed.

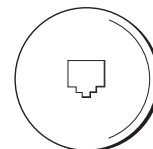

INSTALLATION NOTE: Some cordless telephones operate at frequencies that may cause interference to nearby TVs and VCRs. To minimize or prevent such interference, the base of the cordless telephone should not be placed near or on top of a TV or VCR. If interference continues, moving the cordless telephone farther away from the TV or VCR will often reduce or eliminate the interference.

INSTALLATION OPTIONS

Although you can use your GE 2-line cordless telephone with a single phone line, you must have two lines (separate phone numbers) to use a two-line system. The following diagrams show two possible systems:

Two Lines on Single Modular Jack

One type of two-line phone system uses a single RJ14 modular jack which contains both phone lines. Connect the phone cord to the L1 or L2 jack.

You must use a 4-conductor telephone line cord like the ones that are packed with your unit.

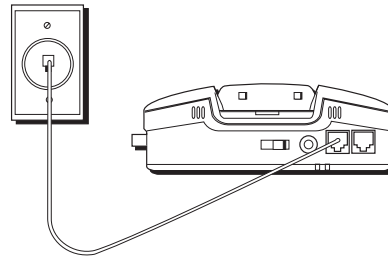

Each Line on a Separate Modular Jack

If you have two separate phone jacks, each with its own line, connect one of the phone cords to the L2 jack, and connect the remaining phone cord to the L1 or L2 phone jack located on the back of the phone.

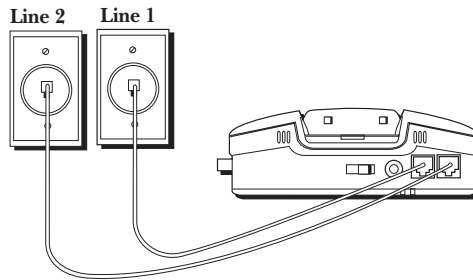

NOTE: Connect the phone cord from the L1 or L2 jack to the outlet that you want to be line 1.

NOTE: Two-line capability requires two-line service from your local telephone company.

DESKTOP INSTALLATION

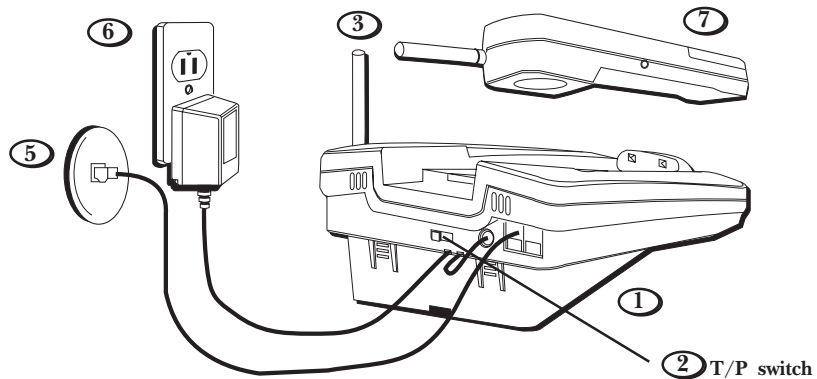

Two Lines on a Single Modular Jack

1. Attach the base plate.
2. Set the T/P switch to T for touch-tone service, or P for pulse (rotary) service. If you don't know which type of service you have, check with the phone company.
3. Raise the base antenna.
4. Set the RING switch to ON so the handset rings for incoming calls.
5. Plug the telephone line cord into the L1 or L2 jack located on the back of the phone and into a dual line modular jack.
6. Plug the power supply cord into the base and into an AC outlet.
7. Place handset in the base to charge for 12 hours. The CHARGE/PAGE light comes on indicating that the battery is charging. **If you don't charge the handset battery properly (for 12 hours) when you first set up the phone, the battery's long-term performance will be compromised.**

NOTE: Use only the Thomson 5-2420A or 5-2420B power supply that came with this unit. Using other adapters may damage the unit.

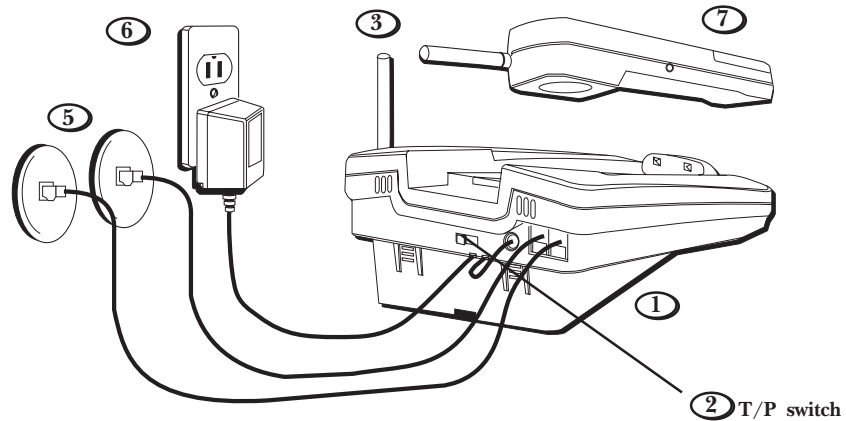

Each Line on a Separate Modular Jack

1. Attach the base plate.
2. Set the T/P switch to T for touch-tone service, or P for pulse (rotary) service. If you don't know which type of service you have, check with the phone company.
3. Raise the base antenna.
4. Set the RING switch to ON so the handset rings for incoming calls.
5. Plug one of the telephone line cords into the L2 jack and into a single line modular jack. Connect the remaining phone cord to the L1 or L2 phone jack located on the back of the phone and into a single line modular jack.
6. Plug the power supply cord into the base and into an AC outlet.
7. Place handset in the base to charge for 12 hours. The CHARGE/PAGE light comes on indicating that the battery is charging. **If you don't charge the handset battery properly (for 12 hours) when you first set up the phone, the battery's long-term performance will be compromised.**

WALL MOUNT INSTALLATION

Two Lines on a Single Modular Jack

1. Remove the handset hook; turn it upside down, and put it back in the slot. You need to do this so the handset doesn't fall out of the base.
2. Plug the telephone line cord into the L1 or L2 jack on the back of the unit. Wrap the extra line cord around the cord wrap on the bottom of the base and then thread it through the top of the base plate.
3. Connect the power supply adapter to the POWER 9V DC jack on the back of the unit. Then thread it through the bottom of base.
4. Reverse the direction of the base plate and replace it by putting the tabs into the slots on the top of the unit first and snapping the bottom tabs into place.
5. Plug the telephone line cord into the dual line modular jack.
6. Slip the mounting holes over the wall plate posts and slide the unit down firmly into place. (Wall plate not included.)
7. Set the T/P switch to T if you have touch-tone service or to P (pulse) if you have rotary dial service.
8. Set the RING switch to ON so the handset rings for incoming calls.
9. Plug the power supply adapter into an AC outlet and raise the antenna.
10. Place the handset in the base to charge for 12 hours. The CHARGE/PAGE light comes on. **If you don't charge the handset battery properly (for 12 hours) when you first set up the phone, the battery's long-term performance will be compromised.**

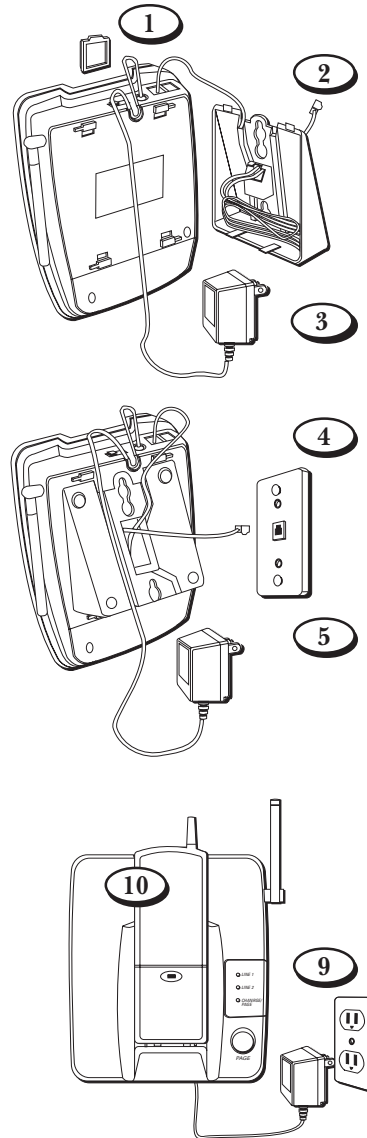

Each Line on a Separate Modular Jack

1. Remove the handset hook; turn it upside down, and put it back in the slot. You need to do this so the handset doesn't fall out of the base.
2. Plug one of the telephone line cords into the L1 or L2 jack on the back of the unit, wrap the extra line cord around the cord wrap on the bottom of the base, and then thread it through the top of the base plate.
3. Plug the remaining telephone line cord into the L2 jack on the back of the unit.
4. Connect the power supply adapter to the POWER 9V DC jack on the back of the unit, and then thread it through the bottom of base.
5. Reverse the direction of the base plate and replace it by putting the tabs into the slots on the top of the unit first, and then by snapping the bottom tabs into place.
6. Plug the telephone line cord from the L1 or L2 jack into a single line modular jack that you want to be line 1.
7. Plug the other telephone line cord into the single line modular jack you want to be line 2.
8. Slip the mounting holes over the wall plate posts and slide the unit down firmly into place. (Wall plate not included.)
9. Set the T/P switch to T if you have touch-tone service or to P (pulse) if you have rotary dial service.
10. Set the RING switch to ON so the handset rings for incoming calls.
11. Plug the power supply adapter into an AC outlet and raise the antenna.
12. Place the handset in the base to charge for 12 hours. The CHARGE/PAGE light comes on. **If you don't charge the handset battery properly (for 12 hours) when you first set up the phone, the battery's long-term performance will be compromised.**

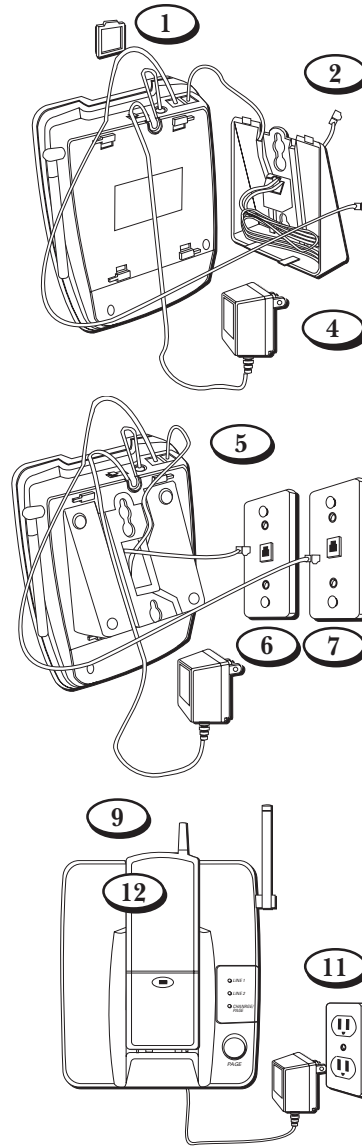

CORDLESS PHONE BASICS

MAKING A CALL

After initial set up, put handset in the base for 12 hours to charge the battery.

The cordless phone automatically selects the last line you used. The only two things you need to know to make a call are:

1. Press LINE 1 or LINE 2 to select a line before you dial.
2. Press LINE 1 or LINE 2 (whichever line you are talking on) or place the handset in the base to hang up.

Otherwise, it works just like any other phone.

NOTE: You can press TALK instead of pressing LINE 1 or LINE 2. The phone defaults to the last line that was used.

LINE INDICATOR LIGHTS

Above each line button is a Red indicator light which informs you the status of each line.

<i>Light</i>	<i>Status</i>
Solid	Line is in use
Blinking	Line on hold

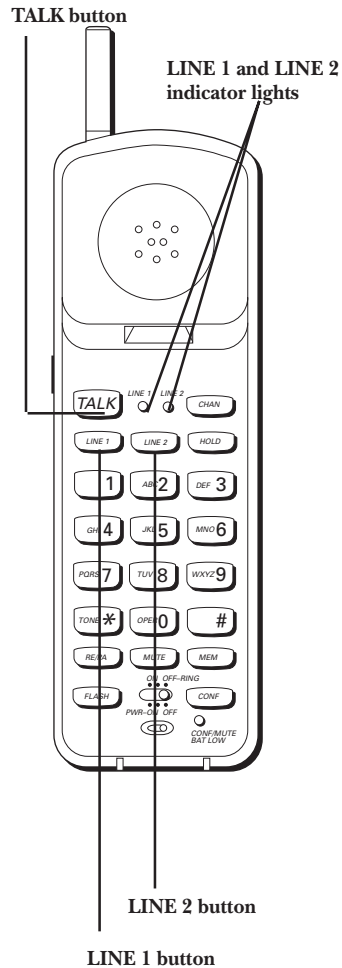

DUAL RINGER TONES

Your cordless telephone has separate and distinct ringer sounds for LINE 1 and LINE 2. This will allow you to determine the line of an incoming call, even in another room. If you are talking on one line and someone calls on the other line, the phone alerts you by sending a signal to the handset's earpiece.

REDIAL(RE/PA)

Press the TALK button, then press the RE/PA (redial/pause) button to redial the last number you called (up to 32 digits).

RECEIVING A CALL

To answer a call when the handset is out of the base, you must press TALK or the LINE 1 or LINE 2 button.

FLASH BUTTON

Use the FLASH button to activate custom calling services such as call waiting or call transfer, which are available through your local phone company.

TIP: If you press the TALK button to activate custom calling services such as call waiting, you'll hang up the phone. Press FLASH instead.

TALK button

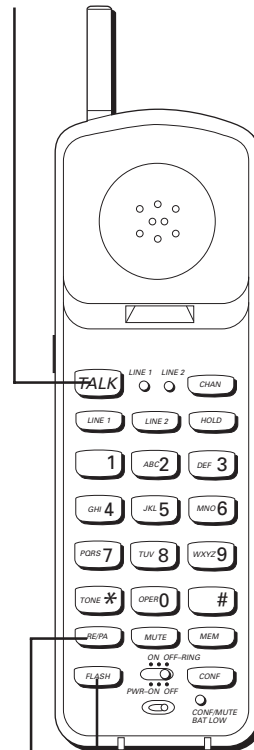

FLASH button

RE/PA
(redial/pause)
button

VOL (VOLUME) SWITCH

Controls the volume of the handset's earpiece.

RING/PWR (RINGER AND POWER) SWITCH

This is a 3-position switch that controls the ringer and handset power.

When you move the switch to the left, the power is on and the ringer is on.

When you move the switch to the middle position, the power is on, but the ringer is off.

When you move the switch to the far right, the power is off and the ringer is off which saves battery power. You must turn PWR to ON (by sliding the switch to the middle or left position) in order to make calls or receive calls.

VOL switch (on the side of the handset)

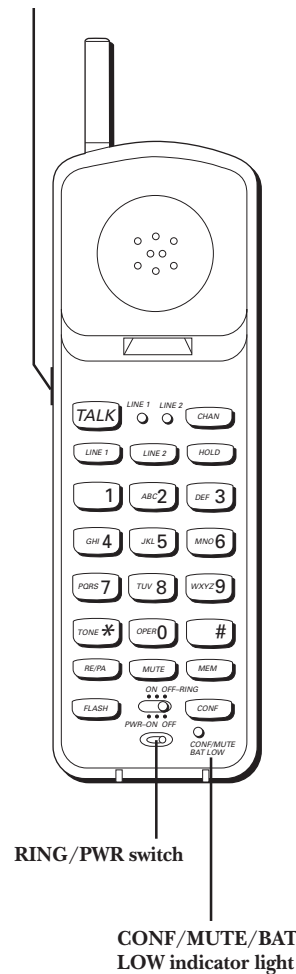

MUTE BUTTON

Use the MUTE button to interrupt a phone conversation to talk privately with someone else in the room.

1. Press MUTE to activate mute feature.
2. Press MUTE again to turn it off.

TEMPORARY TONE

This feature enables pulse (rotary) service phone users to access touch-tone services offered by banks, credit card companies, etc., by pressing the TONE button to temporarily make the phone touch-tone compatible. To get information about your bank account, for example, you would:

1. Press the TALK button.
2. Call the bank's information line.
3. Press the TONE button after your call is answered.
4. Follow the voice instructions to complete your transaction.
5. Hang up when finished. The phone returns to pulse (rotary) service.

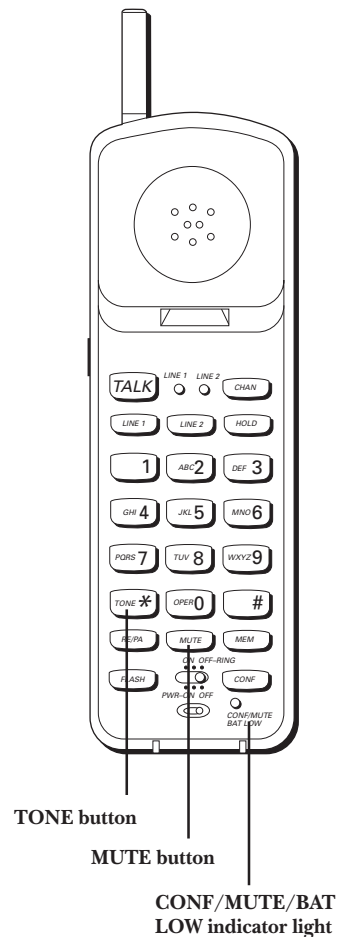

HOLD BUTTON

You can use the HOLD button to interrupt a phone conversation without hanging up.

1. Press HOLD to place the party on hold.
2. Press HOLD again to resume the conversation.

CONFERENCE BUTTON

You can use the conference call feature when you have callers on both lines and want to have a three-way conversation.

1. Press HOLD to place the party on hold.
2. Press the other LINE button.
3. Dial the number of the second party.
4. Press the CONF button.
5. Press LINE 1 or LINE 2 when finished to talk privately and disconnect the other line.
6. Press LINE 1 or LINE 2 for whichever line you are talking on or place the handset in the base to hang up.

PAGING THE HANDSET

Press the PAGE button on the base or to locate a misplaced handset. When you press the PAGE button, the handset beeps. Press the TALK button when you locate the handset. Remember that the ringer must be **ON** in order for the handset to ring.

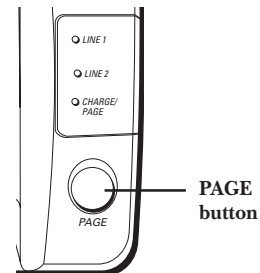
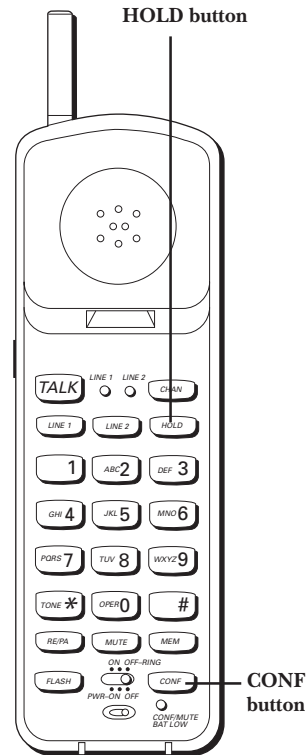

ADVANCED FEATURES

CHANNEL BUTTON (CHAN)

If you ever experience any interference or don't have clear voice quality, press the CHAN button on the handset to advance to another channel.

THE MEMORY FEATURE

Store up to 10 numbers in memory for quick dialing.

STORING A NUMBER IN MEMORY

The phone must be off (PWR button on, but no dial tone) when you store numbers.

1. Press the MEM button
2. Dial the number (up to 24 digits).
3. Press MEM.
4. Press any number key (0-9) to store the phone number in that memory location.

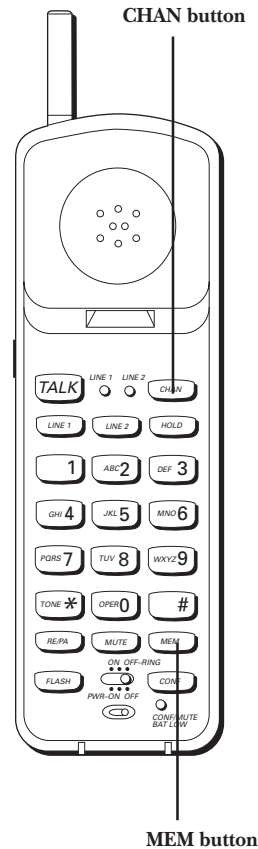

CHANGING A STORED NUMBER

Use the same procedure to change a stored number as you do to store a number— you're just moving the phone number to a different memory location.

STORING A REDIAL NUMBER

1. Press MEM.
2. Press RE/PA (redial/pause).
3. Press MEM.
4. Press any number key (0-9) to store the phone number in that memory location.

STORING A PAUSE IN MEMORY

Use the RE/PA button to insert a pause when a delay is needed in the dialing sequence (for example, when you must dial a 9 to get an outside line or when you must enter codes to access your bank's information line).

If you need to dial 9 to get an outside line and want to store a number in memory without having to dial 9 each time, you would:

1. Press MEM.
2. Press 9.
3. Press RE/PA (redial/pause).
4. Dial the phone number you want to store in memory.
5. Press MEM.
6. Press any number key (0-9) to store the phone number in that memory location.

TIP: If you need a longer pause, press RE/PA button more times.

DIALING A STORED NUMBER

1. Press the TALK button to get a dial tone.
2. Press MEM and then press the number for that memory location.

CHAIN DIALING FROM MEMORY

Use this feature to make calls which require a sequence of numbers, for instance if you use a calling card for a frequently called long distance number. Basically, you dial each part of the sequence from memory. The following example shows how you can use chain dialing to make a call through a long distance service:

<i>The Number For</i>	<i>Memory Location</i>
Long distance access number	7
Authorization code	8
Frequently called long distance number	9

1. Press the TALK button to get a dial tone.
2. Press the MEM button and then press 7.
3. When you hear the access tone, press MEM and then press 8.
4. At the next access tone, press MEM and then 9.

CONNECTING A HEADSET TO THE HANDSET

For hands free conversation, a headset (not included) can be connected to the HEADSET jack as shown. The handset receiver and microphone are disabled when the headset is connected.

- Press the TALK button or the LINE 1 or LINE 2 button to answer or place a call before using the headset. Refer to the headset manual for more details.

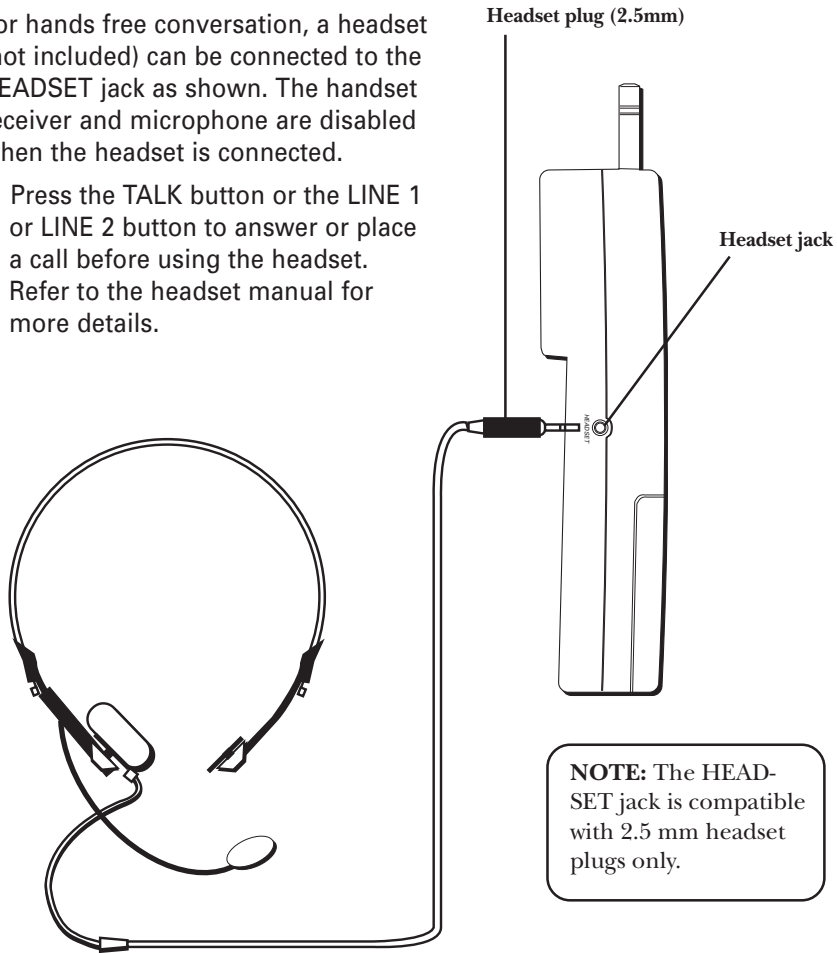

CONNECTING THE BELT CLIP

There are two slots, one on each side of the handset.

- Attach the belt clip (not included) by inserting the sides of the belt clip into the slots. Snap the ends of the belt clip into place.

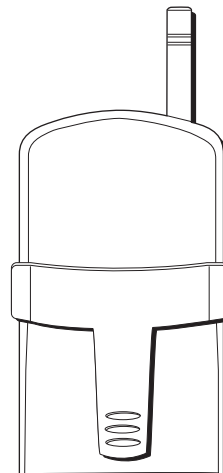
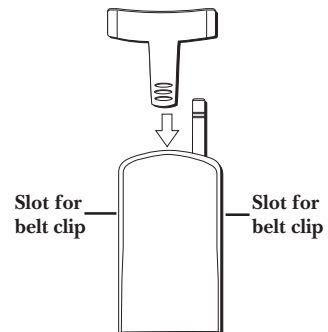

CHANGING THE BATTERY

Make sure phone is **OFF** before you replace battery.

1. Remove the battery compartment door.
2. Disconnect the cord attached to the battery pack and remove the battery pack from the handset.
3. Insert the new battery pack and connect the cord into the jack inside the handset.
4. Put the battery compartment door back on.
5. **If you don't charge the handset battery properly (for 12 hours) when you first set up the phone and/or when you install a new battery pack, the battery's long-term performance will be compromised.**

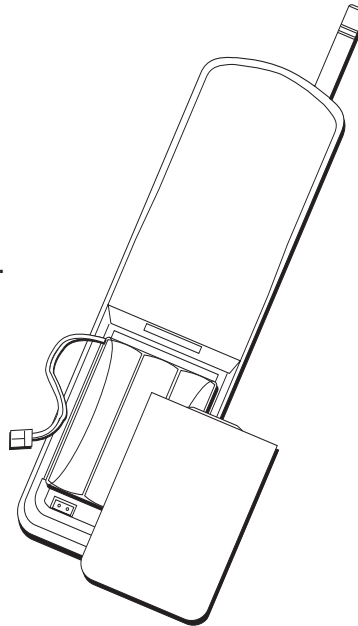

BATTERY SAFETY PRECAUTIONS

- Don't disassemble, mutilate, puncture, wet, or dispose of battery in fire. Like other batteries of this type, if it is burned or punctured, it could release toxic materials which can cause injury.
- Keep batteries out of the reach of children.



NOTE: The RBRC seal on the battery used in your Thomson Consumer Electronics product indicates that we are participating in a program to collect and recycle Nickel Cadmium batteries throughout the United States of America. Please call 1-800-8-BATTERY for information or contact your local recycling center.

TROUBLESHOOTING GUIDE

In case of difficulty, please check the following Troubleshooting Guide before seeking service.

<i>Problem</i>	<i>Solution</i>
No dial tone	<ul style="list-style-type: none">• Check installation:<ul style="list-style-type: none">— Is the base power cord connected to a working outlet?— Is TALK light on?— Is the telephone line cord connected to the base unit and the wall jack?— Is a headset connected to the handset? The handset receiver and microphone are temporarily disabled when you connect the headset• Disconnect the base from the wall jack and connect another phone to the same jack. If there is no dial tone in the second phone, the problem might be your wiring or local service.• Is the handset out of the base unit's range? Move closer to the base unit.• Make sure the battery is properly charged (12 hours).• Is the battery pack installed correctly? See page 18.• If the phone still does not work, disconnect the power cord and remove the battery pack. Then reconnect the power cord and reinstall the battery pack. Place handset in the base for 10 seconds to allow it to reinitialize.• Make sure RING/PWR switch on the handset is turned on.
Dial tone is OK, but can't dial out	<ul style="list-style-type: none">• Make sure the T/P switch on the base is set correctly (see pp. 4-7).
Handset does not ring	<ul style="list-style-type: none">• Make sure the RING/PWR switch on the handset is turned to ON (the far left position).• You may have too many extension phones on your line. Try unplugging some phones.• See solutions for "No dial tone."
Cannot hear phone conversation	<ul style="list-style-type: none">• Set the volume control on side of handset to HI.
You experience static, noise, or fading in and out	<ul style="list-style-type: none">• Change channels.• Is handset out of range? Move closer to the base.• Does the base need to be relocated?• Charge handset battery.• Make sure base is not plugged into an outlet with another household appliance.

TROUBLESHOOTING GUIDE (CONTINUED)

<i>Problem</i>	<i>Solution</i>
Cannot hear the Page alert tone	<ul style="list-style-type: none">• Set the RING/PWR switch on the handset to ON (the far left position).
Range is shorter than normal	<ul style="list-style-type: none">• Press the CHAN button during the conversation to select a new channel.• Position the base antenna upward.
Battery will not hold a charge OR is fully charged and the BAT LOW lights	<ul style="list-style-type: none">• Be sure you are sufficiently charging the battery. When the battery has been charged for 12 hours, you can expect approximately 4 hours of talk time.• Check to be sure battery contacts on both the handset and the base are making contact and are clean; free of dirt or lint.• When the handset is placed in the base, check that the base CHARGE light is on.
BAT LOW light stays on	<ul style="list-style-type: none">• Place handset in base for 10 seconds to reset the phone. If that doesn't work, charge battery for 12 hours.
Memory Dialing doesn't work	<ul style="list-style-type: none">• Did you program the memory location keys correctly? See p. 12.• Did you follow proper dialing sequence? See pp. 13-15.• Make sure T/P switch is correctly set. See pp. 4-7.
Unit locks up	<ul style="list-style-type: none">• If the unit doesn't work, reset the unit by disconnecting and reconnecting the handset battery and then return the handset to the base.• If a power outage occurs while the handset is away from the base, the handset must be returned to the base when the power returns.
While using the headset, you can't hear the caller and the caller can't hear you.	<ul style="list-style-type: none">• Make sure the headset is plugged into the handset. When you plug in the headset, the handset receiver and microphone are disabled.• Unplug the headset if you want to use the handset instead.

GENERAL PRODUCT CARE

To keep your telephone working and looking good, follow these guidelines:

- Avoid putting the phone near heating appliances and devices that generate electrical noise (for example, motors or fluorescent lamps).
- DO NOT expose to direct sunlight or moisture.
- Avoid dropping the handset, as well as other rough treatment to the phone.
- Clean the phone with a soft cloth.
- Never use a strong cleaning agent or abrasive powder because this will damage the finish.
- Retain the original packaging in case you need to ship the phone at a later date.
- Periodically clean the charge contacts on the handset and base with a eraser.

CAUSES OF POOR RECEPTION

- Aluminum siding.
- Foil backing on insulation.
- Heating ducts and other metal construction can shield radio signals.
- You're too close to appliances such as microwaves, stoves, computers, etc.
- Atmospheric conditions, such as strong storms.
- Base is installed in the basement or lower floor of the house.
- Base is plugged into an AC outlet with other electronic devices.
- Baby monitor is using the same frequency.
- Handset battery is low.
- You're out of range of the base.

SERVICE

The FCC requires this product to be serviced only by the manufacturer or its authorized service agents. In accordance with FCC requirements, changes or modifications not expressly approved by Thomson Consumer Electronics could void the user's authority to operate this product. For instructions on how to obtain service, refer to the warranty included in this guide or call customer service at 1-800-448-0329.

Attach your sales receipt to the booklet for future reference or jot down the date this product was purchased or received as a gift. This information will be valuable if service should be required during the warranty period.

Purchase date _____ Name of store _____

CUSTOMER: CUT ALONG DOTTED LINE. ✂

ACCESSORY ORDER FORM

DESCRIPTION	CATALOG NUMBER	PRICE*	QUANTITY	TOTAL
Replacement handset battery	5-2358	\$14.95		
AC power supply adapter	5-2420A or B	\$9.95		
Belt clip	5-2426	\$4.75		
Headset	5-2425	\$26.35		

*Prices are subject to change without notice.

Total Merchandise.....\$ _____

For credit card purchases
Your complete charge card number, its expiration date and your signature are necessary to process all charge card orders.

Copy your complete account number from your VISA card.

<input type="text"/>	<input type="text"/>	<input type="text"/>	<input type="text"/>	<input type="text"/>	<input type="text"/>	<input type="text"/>	<input type="text"/>	<input type="text"/>	<input type="text"/>
----------------------	----------------------	----------------------	----------------------	----------------------	----------------------	----------------------	----------------------	----------------------	----------------------

My card expires:

<input type="text"/>	<input type="text"/>
----------------------	----------------------

Copy your complete account number from your MasterCard.

<input type="text"/>	<input type="text"/>	<input type="text"/>	<input type="text"/>	<input type="text"/>	<input type="text"/>	<input type="text"/>	<input type="text"/>	<input type="text"/>	<input type="text"/>
----------------------	----------------------	----------------------	----------------------	----------------------	----------------------	----------------------	----------------------	----------------------	----------------------

Copy the number above your name on the MasterCard

<input type="text"/>	<input type="text"/>
----------------------	----------------------

My card expires:

<input type="text"/>	<input type="text"/>
----------------------	----------------------

We are required by law to collect the appropriate sales tax for each individual state, county, and locality to which the merchandise is being sent.

Sales Tax.....\$ _____

Use VISA or MasterCard preferably. Money order or check must be in U.S. currency only. No COD or Cash.

All accessories are subject to availability. Where applicable, we will ship a superseding model.

Shipping, Handling, and Insurance.....\$ **\$5.00**

Total Amount Enclosed.....\$ _____

Mail order form and money order or check (in U.S. currency) made payable to Thomson Consumer Electronics, Inc. to:

Consumer Electronics
Mail Order Department
P.O. Box 8419
Ronks, PA 17573-8419

This is your return label. Please print clearly.

To:

Name _____ Apt. _____
Address _____
City _____ State _____ ZIP _____

Authorized Signature _____

Please make sure that this form has been filled out completely.

ACCESSORY ORDER FORM

To fulfill your communicating needs and enhance your life-style, a wide range of GE extension phones, main phones, cordless phones and answering systems is available.

Just stop by your nearest retailer and ask to see the wide range of GE telephone products.

All are carefully engineered to offer you high quality and dependability, modern easy-to-use features, and elegant styling at an affordable price.

Should you wish to purchase, insist on the GE brand for all your communicating needs.



INDEX

A

Accessory Order Form 23

B

Battery
installation 18

Battery safety 18

Buttons

CHAN 13

FLASH 9

MEM 13, 14, 15

MUTE 11

PAGE 12

PWR-ON OFF 10

RE/ PA 9

RING – OFF ON 10

TONE 11

C

Chain dialing 15

Changing a stored number 14

CHAN (channel) button 13

CHARGE/PAGE light 4, 5, 6, 7

Cleaning the phone 21

D

Dialing a stored number 15

F

FLASH button 9

I

Installation 3, 4, 5, 6, 7

M

Making a call 8

MEM button 13, 14, 15

Memory feature 13

Memory location 13

P

PAGE button 12

Paging the handset 11

Poor reception 21

Product care 21

R

Receiving a call 9

RE/PA (redial/pause) 9

Ring switch 4, 5, 6, 7

S

Service 21

Storing a number in memory 13

Storing a redial number 14

T

Temporary tone 11

TONE button 11

Troubleshooting Guide 19

V

VOL Button 10

W

Wall Mount Installation 6, 7

LIMITED WARRANTY

What your warranty covers:

- Any defect in materials or workmanship.

For how long after your purchase:

- One year.
(The warranty period for rental units begins with the first rental or 45 days from date of shipment to the rental firm, whichever comes first.)

What we will do:

- Provide you with a new or, at our option, a refurbished unit.
- The exchange unit is under warranty for the remainder of the original product's warranty period.

How to make a warranty claim:

- Properly pack your unit. Include any cables, etc., which were originally provided with the product. We recommend using the original carton and packing materials.
- Include in the package evidence of purchase date such as the bill of sale. Also print your name and address and a description of the defect. Send standard UPS or its equivalent to:

Thomson Consumer Electronics, Inc.
Product Exchange Center
32 Spur Drive
El Paso, Texas 79906

- Pay any charges billed to you by the Exchange Center for service not covered by the warranty.
- Insure your shipment in case of loss or damage. Thomson accepts no liability in case of damage or loss.
- A new or refurbished unit will be shipped to you prepaid freight.

What your warranty *does not* cover:

- Customer instruction. (Your Owner's Manual provides information regarding operating instructions and user controls. For additional information, ask your dealer.)
- Installation and set-up service adjustments.
- Batteries.
- Damage from misuse or neglect.
- Products which have been modified or incorporated into other products.
- Products purchased or serviced outside the USA.
- Acts of God, such as but not limited to lightning damage.

Product Registration:

- Please complete and mail the Product Registration Card packed with your unit. It will make it easier to contact you should it ever be necessary. The return of the card is not required for warranty coverage.

How state law relates to this warranty:

- This warranty gives you specific legal rights, and you may have other rights which vary from state to state.

If you purchased your product outside the USA:

- This warranty does not apply. Contact your dealer for warranty information.

Model 2-9925
20807550 (Rev. 1 E/S)
97-28
Printed in China

 **THOMSON CONSUMER ELECTRONICS**
© 1997 Thomson Consumer Electronics, Inc.
P.O. BOX 1976, Indianapolis, IN 46206
Trademark(s) ® Registered
Marca(s) Registrada(s)