

CONTENTS

About Caller ID (CID) 1
 About TeleZapper 1
 Important Safety Instructions 2
 Battery Safety Instructions 2
 FCC Statement 3
 Surge Protection 3
 Installation 3
 Operation 5
 Using The Telezapper® 5
 Operating Range 6
 Settings 6
 Making And Receiving Calls 6
 Memory Dialing 7
 Telephone Directory 8
 Caller ID Operation 9
 Reviewing Call History 10
 TAD Operation 10
 Setting Date/Time 10
 Recording Your Announcement 11
 Setting Up Your Answering System 11
 Playing Messages 11
 Recording a Memo 12
 Answering System Operation Access
 from a Remote Location 12
 Remote Access Commands 13
 Troubleshooting 14
 Care 15
 Service and Repair 15
 Specifications 16

Thank you for purchasing a RadioShack 2.4 GHz Cordless Telephone. Your phone uses advanced technology to give you superior audio quality and extended range. The phone's Caller ID feature records each caller's telephone number (and name, if available in your area) and the date and time of the call, as provided by your local phone company to Caller ID service subscribers. If you subscribe to Call Waiting with Caller ID, the phone shows you the incoming caller information, even when you are already talking on the phone.

The answering system stores up to 16 minutes, or up to 99 messages without the use of tapes or tape mechanisms.

This phone's *Dual Band* transmission combines the best of 2.4GHz and 900MHz technologies, providing enhanced performance over standard cordless telephones.

ABOUT CALLER ID (CID)

This product has a Caller ID with Call Waiting feature that works with service from your local phone service provider. Caller ID with Call Waiting lets you see who's calling before you answer the phone, even when you're on another call. You may need to change your phone service to use this feature. Contact your phone service provider if:

- You have both Caller ID and Call Waiting, but as separate services (you may need a combined service).
- You have only Caller ID service, or only Call Waiting service.
- You don't subscribe to any Caller ID or Call Waiting services.

You can use this product with regular Caller ID service, and you can use this product's other features without subscribing to either Caller ID or combined Caller ID with Call Waiting service. There are fees for Caller ID services, and some services may not be available in all areas.

This product can provide information only if both you and the caller are in areas offering Caller ID service, and if both telephone companies use compatible equipment.

ABOUT TELEZAPPER

The TeleZapper feature in your phone is a patented device that helps you eliminate

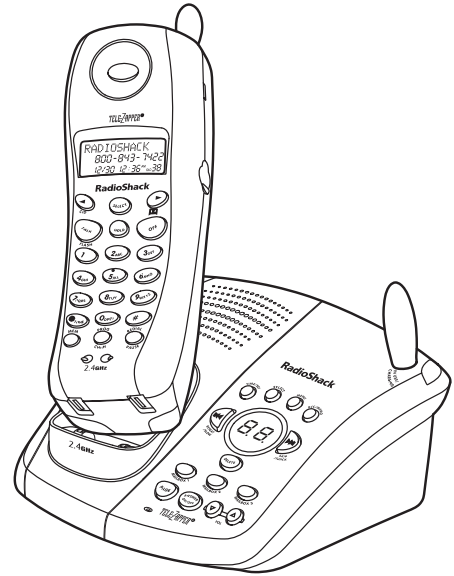

many of those annoying telemarketing calls. The TeleZapper feature covers all the telephones and answering machines connected to that line in your home or office. When you or your answering machine pick up the phone, the TeleZapper emits a special tone that fools many computer-based dialing systems into thinking your number is disconnected. Instead of connecting you to a salesperson, the computer drops the call and stores your number as disconnected in its database. As your number is eliminated from more and more lists, those annoying computer-generated calls just about stop altogether.

The TeleZapper won't interfere with manually dialed calls, or with answering machines, Caller ID or Call Waiting.

Once you've activated the TeleZapper feature in your phone, if you answer your telephone and there's no one there, the odds are that you just "zapped" a telemarketer. After a few weeks, you'll notice that you are receiving fewer and fewer of these calls.

The TeleZapper even works with your answering machine to "zap" telemarketers when you are away or when you prefer not to answer the phone. When your answering machine picks up a call for you, the TeleZapper emits its special tone to "zap" the telemarketer. We recommend that you re-record your message and delay speaking for a few seconds to allow time for the TeleZapper tone prior to the start of your recorded message.

! IMPORTANT !

If an icon appears at the end of a paragraph, go to the box on that page with the corresponding icon for pertinent information.

! — Important

□ — Note

⚡ — Caution

IMPORTANT SAFETY INSTRUCTIONS





When using your telephone equipment, basic safety precautions should always be followed to reduce the risk of fire, electric shock and injury to persons, including the following:

1. Read and understand all instructions.
2. Follow all warnings and instructions marked on the product.
3. Unplug this product from the wall outlet before cleaning. Do not use liquid cleaners or aerosol cleaners. Use a damp cloth for cleaning.
4. Do not use this product near water (for example, near a bath tub, kitchen sink, or swimming pool).
5. Do not place this product on an unstable cart, stand, or table. The product may fall, causing serious damage to the product.
6. Slots and openings in the cabinet and the back or bottom are provided for ventilation. To protect it from overheating, these openings must not be blocked by placing the product on the bed, sofa, rug, or other similar surface. This product should never be placed near or over a radiator or heat register. This product should not be placed in a built-in installation where proper ventilation is not provided.
7. This product should be operated only from the type of power source indicated on the marking label. If you are not sure of the type of power supply to your home, consult your dealer or local power company.
8. Do not allow anything to rest on the power cord. Do not locate this product where the cord will be abused by persons walking on it.
9. Never push objects of any kind into this product through cabinet slots as they may touch dangerous voltage points or short out parts that could result in a risk of fire or electric shock. Never spill liquid of any kind on the product.
10. To reduce the risk of electric shock, do not disassemble this product, but take it to an authorized service facility. Opening or removing cabinet parts other than specified access doors may expose you to dangerous voltages or other risks. Incorrect reassembling can cause electric shock when the appliance is subsequently used.
11. Do not overload wall outlets and extension cords as this can result in the risk of fire or electric shock.
12. Unplug this product from the wall outlet and refer servicing to an authorized service facility under the following conditions:
 - When the power supply cord or plug is damaged or frayed.
 - If liquid has been spilled into the product.
 - If the product has been exposed to rain or water.
 - If the product does not operate normally by following the operating instructions. Adjust only those controls that are covered by the operating instructions, because improper adjustment of other controls may result in damage and will often require extensive work by an authorized technician to restore the product to normal operation.
 - If the product has been dropped and the cabinet has been damaged.
 - If the product exhibits a distinct change in performance.
13. Avoid using a telephone (other than a cordless type) during an electrical storm. There may be a remote risk of electric shock from lightning.
14. Do not use the telephone to report a gas leak in the vicinity of the leak.

BATTERY SAFETY INSTRUCTIONS

1. Use only the appropriate type and size battery pack specified in the instruction manual provided for this product.
2. Do not dispose of the battery pack in a fire. The cell may explode. Check with local codes for possible special disposal instructions.
3. Do not open or mutilate the battery pack. Released electrolyte is corrosive and may cause damage to the eyes or skin. It may be toxic if swallowed.
4. Exercise care in handling the battery pack in order not to short it with conducting materials such as rings, bracelets, and keys. The battery or conductor may overheat and cause burns.
5. Charge the battery pack provided or identified for use with this product only in accordance with the instructions and limitations specified in the instruction manual provided for this product.
6. Observe proper polarity orientation between the battery pack and battery charger.

Save These Instructions

WARNING: To reduce the risk of fire or shock hazard, do not expose this product to rain or moisture.	
 CAUTION 	 The lightning symbol is intended to alert you to the presence of uninsulated dangerous voltage within this product's enclosure that might be of sufficient magnitude to constitute a risk of electric shock. Do not open the product's case.
RISK OF ELECTRIC SHOCK DO NOT OPEN	
CAUTION: TO REDUCE THE RISK OF ELECTRICAL SHOCK, DO NOT REMOVE COVER OR BACK. NO USER-SERVICEABLE PARTS INSIDE. REFER SERVICING TO QUALIFIED PERSONNEL.	 The exclamation mark symbol is intended to inform you that important operating and maintenance instructions are included in the literature accompanying this product.

FCC STATEMENT

[This phone is Hearing Aid compatible.]

This device complies with Part 15 of the FCC Rules. Operation is subject to the following two conditions: (1) this device may not cause harmful interference, and (2) this device must accept any interference received, including interference that may cause undesired operation.

This telephone has been tested and found to comply with all applicable UL and FCC standards

Your phone complies with Part 68 of *FCC Rules*. You must, upon request, provide the FCC registration number and the REN to your telephone company. Both numbers are located on the bottom of the phone.

You must not connect your phone to:

- coin-operated systems
- most electronic key telephone systems

Your phone is not intended to be used with party-line systems. Connection to party line service is subject to state tariffs. Contact the state public utility commission, public service commission, or corporation commission for information.

We have designed your phone to conform to federal regulations, and you can connect it to most telephone lines. However, each phone (and each device, such as a telephone or answering machine) that you connect to the telephone line draws power from the telephone line. We refer to this power draw as the device's ringer equivalence number, or REN on the bottom of your phone.

If you use more than one phone or other device on the line, add up all of the RENs. If the total is more than five (three in rural areas), your telephones might not ring. If ringer operation is impaired, remove a device from the line.

In the unlikely event that your phone causes problems on the phone line, the phone company can temporarily discontinue your service. If this happens, the phone company attempts to notify you in advance. If advance notice is not practical, the phone company notifies you as soon as possible and advises you of your right to file a complaint with the FCC.

Also, the phone company can make changes to its lines, equipment, operations, or procedures that could affect the operation of this phone. The telephone company notifies you of these changes in advance, so you can take the necessary steps to prevent interruption of your telephone service.

If your home has specially wired alarm equipment connected to the telephone line, be sure that installing the phone does not disable your alarm equipment. If you have

questions about what will disable your alarm equipment, contact your telephone company or a qualified installer.

SURGE PROTECTION

Your phone has built-in protection circuits to reduce the risk of damage from surges in telephone line and power line current. These protection circuits meet or exceed the FCC requirements; however, lightning striking the phone or power lines can damage your phone.

Lightning damage is not common. Nevertheless, if you live in an area that has severe electrical storms, we suggest you unplug your phone when storms approach to reduce the possibility of damage.

INSTALLATION

Your phone connects directly to a modular telephone line jack. If your telephone wiring does not have a modular jack, you can update the wiring yourself using jacks and adapters (available at your local RadioShack store), or have the telephone company update the wiring for you. You must use compatible modular jacks that are compliant with Part 68 of *FCC Rules* and the requirements adopted by the ACTA. The telephone cord and modular plug provided is Part 68 compliant for connecting to the telephone company network.

Selecting a Location

You can place the phone's base on a desk or table, or mount it on the standard wall plate. Select a location that is:

- near an accessible AC outlet 
- near a telephone line jack
- out of the way of normal activities
- away from electrical machinery, electrical appliances, metal walls or filing cabinets, wireless intercoms, alarms, and room monitors
- away from other cordless phones

The base's location affects the handset's range. If you have a choice of several locations, try each to see which provides the best performance.

Your telephone connects directly to a modular telephone line jack. If your telephone wiring does not have a modular jack, you can update the wiring yourself using jacks and adapters (available at your local RadioShack store), or have the telephone company update the wiring for you. You must use compatible modular jacks that are compliant with Part 68 of FCC Rules.

On a Desk Top

1. Plug one end of the supplied modular cord into the **TEL LINE** jack on the bottom of the base.

NOTE

The USOC number of the jack to be installed is RJ11C (or RJ11W for a wall plate jack).

! IMPORTANT !

- Cordless phones require AC power to operate. When the power is off, you cannot make or receive calls using your phone. You should also have a phone that does not need AC power to operate (not a cordless phone), so you can still make and receive calls if there is an AC power failure.
- When AC power is lost, the phone loses the security access-protection code connection between the base and the handset. When power is restored, put the handset on the base briefly to restore this connection so you can use the handset.
- Your phone operates on standard radio frequencies allocated by the FCC.
- It is possible for other radio units operating nearby on similar frequencies to unintentionally intercept your conversation or cause interference. This possible lack of privacy can occur with any cordless phone.

CAUTION

- You must use a Class 2 power source that supplies 9V DC and delivers at least 400 mA. Its center tip must be set to positive and its plug must fit the phone's 9V DC jack. The supplied adapter meets these specifications. Using an adapter that does not meet these specifications could damage the phone or the adapter.
- Always connect the AC adapter to the phone before you connect it to AC power. When you finish, disconnect the adapter from AC power before you disconnect it from the phone.

NOTES

Wall Mount Installation on a Standard Modular Wall Plate

Install the Base Unit away from electronic equipment, such as personal computers, television sets or microwave ovens. Avoid excessive heat, cold, dust or moisture.

Connecting/Charging the Battery Pack

- This battery should remain charged up to five days with the ringer turned on and up to 12 days with the ringer off. A fully charged battery provides an average talk time of about six hours.
- Place the Handset in the Base so the **CHARGING** light turns on. The battery pack is typically fully charged in 10 hours.
- You can keep the battery fully charged by returning the Handset to the Base after each use.
- If you repeatedly get a low battery indicator, even after charging overnight, the battery should be replaced.
- Be sure the battery pack is properly connected before you try to charge it. The IN USE/CHARGING indicator lights when the handset is on the base, even if the battery pack is not connected.

BATTERY NOTES

- Dispose of old batteries promptly and properly.
- Do not mix old and new batteries, different types of batteries (standard, alkaline, or rechargeable), or rechargeable batteries of different capacities.
- If you do not plan to use the phone for over a month, remove the batteries. Batteries can leak chemicals that can damage electronic parts.

! IMPORTANT !

The EPA certified RBRC® Battery Recycling Seal on the nickel-cadmium (Ni-Cd) battery indicates RadioShack is voluntarily participating in an industry program to collect and recycle these batteries at the end of their useful life, when taken out of service in the United States or Canada. The RBRC program provides a convenient alternative to placing used Ni-Cd batteries into the trash or the municipal waste stream, which may be illegal in your area. Please call 1-800-THE-SHACK (1-800-843-7422) for information on Ni-Cd battery recycling and disposal bans/restrictions in your area. RadioShack's involvement in this program is part of the company's commitment to preserving our environment and conserving our natural resources



2. Route the cord through the grooves on the bottom of the base.
3. Plug the modular cord's other end into a modular phone line jack.
4. Insert the supplied AC adapter's barrel plug into the **9V DC** jack on the bottom of the base.
5. Route the adapter's cord through the grooves on the bottom of the base. Then plug the adapter into a standard AC outlet.

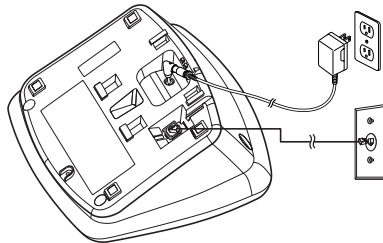

Wall Mount Installation on a Standard Modular Wall Plate

To mount the phone on a wall using the supplied T-shape bracket, you need two screws (not supplied) with heads that fit into the keyhole slots on the bracket.

1. Drill two holes 3.25 inches (83 mm) apart. Then thread a screw into each hole, letting the heads extend about 1/8 inch (3 mm) from the wall.

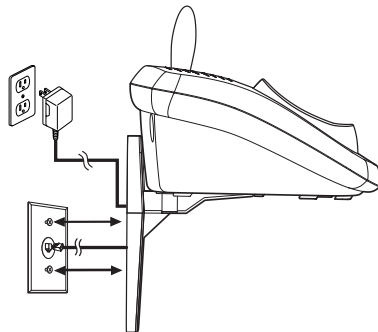

2. Run the supplied AC adapter's cord and the supplied module cords through the slots in the supplied bracket.
3. Insert the AC adapter's barrel plug into the **9V DC** jack on the bottom of the base.
4. Plug one end of the supplied modular cord into the **TEL LINE** jack on the bottom of the base.
5. Route the adapter and modular cords through the grooves on the bottom of the base.
6. Insert the bracket's tabs to the base's slots and align the studs with the base's slots. Then press the base down until it locks into place.
7. Align the bracket's keyhole slots with the mounting screws and slide the bracket downward to secure it.

8. Plug the modular cord's other end into the phone jack, and plug the adapter into a standard AC outlet.

To remove the base from the bracket, press both studs on the bracket and lift the base from the bracket.

Use the Belt Clip

Attach the supplied belt clip to the cordless handset (optional).

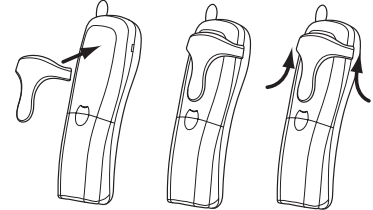

Connecting/Charging the Battery Pack

The phone comes with a rechargeable nickel-cadmium battery pack in the handset, but not connected. Before using your phone, you must connect the battery pack. Then charge it for about 12 hours.

1. Press down and slide off the battery compartment cover.
2. Lift the battery pack out of the compartment.
3. Plug the battery pack's connector into the socket in the compartment (the connector fits only one way). Then snap the battery pack to the battery holder in the compartment.
4. Replace the cover.

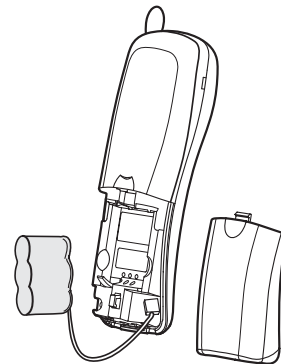

To charge the battery pack, power the base using the AC adapter and place the handset on the base. The IN USE/CHARGING indicator on the base lights.

If the phone beeps twice every five seconds during a call, or the screen displays **BATTERY LOW**, or **NEEDS RECHARGING**, recharge the battery.!

Use a pencil eraser to clean the charging contacts on the handset and the base about once a month.

OPERATION

USING THE TELEZAPPER®

Programming Instructions

The TeleZapper feature in your phone has two levels of privacy to help “zap” computer dialed telemarketing calls. Your phone is shipped with the basic level of privacy activated, which will help with the majority of telemarketing calls. At this level, the TeleZapper feature will emit a single tone, which is the first of three (3) tones for the disconnected signal. The advanced level of privacy will switch the TeleZapper feature to all three tones of the disconnected signal and will “zap” even more telemarketing calls. Here are instructions to switch from basic to advanced privacy or to disable the feature. ☑

1. Lift the handset and press **PROG/CHAN**. Then press **◀** until the screen displays **TELEZAPPER**, and the current setting.
2. Press **SELECT**. The current option is flashing.
3. Use **◀** or **▶** to choose **BRS** (basic), **ADV** (advance) or **OFF**.
4. Press **SELECT** to activate the selected option.

TeleZapper Q&A:

Q. How does the TeleZapper feature work?

A. The TeleZapper uses the technology of telemarketers' automatic dialing equipment against them. When you or your answering machine pick up a call, the TeleZapper emits a special tone that “fools” the computer into thinking your number is disconnected. Instead of connecting you to a salesperson, the computer stores your number as disconnected in its database. Over time, as your number is removed from more and more databases, you'll see a dramatic decrease in the number of annoying telemarketing calls you receive.

Q. How do I know when I've “zapped” a telemarketer?

A. If you answer your telephone and there's no one there, the odds are that you just “zapped” a telemarketer. Quite often you will see the caller ID from such a call is “unavailable.” After a few weeks, you will notice that you receive fewer and fewer of these calls.

Q. Do I need one for each telephone or telephone jack in my home or office?

A. No. One phone with the TeleZapper feature covers *all* telephones and answering machines connected to the same line (telephone number). If you have two lines, you need an additional unit for your other line.

Q. Will it interfere with my computer or fax machine?

A. No. The TeleZapper does not interfere with the operation of your computer, your fax machine or other telecommunications or electronic equipment. It plays the tone briefly when the line is answered. Then goes to “sleep” waiting for the next call.

Q. Will it interfere with my answering machine?

A. No. This is the best way to use your TeleZapper feature. Let your answering machine pick up the line. The TeleZapper feature “zaps” the telemarketer, and you were not bothered at all! You will need to delay your message for a few seconds to allow the tone to play. A caller who wishes to leave a message on your answering machine will hear a short tone followed by your recording.

Q. I have voicemail from the telephone company. Will it work with this?

A. Yes and No. Your telephone must go “off-hook” for the TeleZapper to emit its tone. As long as you pick up a call, the phone goes “off-hook” and the TeleZapper emits its tone to “zap” telemarketers. If, instead, the telephone company “answers” your calls through voicemail, your phone does not go “off-hook” and the TeleZapper cannot emit its tone. The TeleZapper will not interfere with the normal operation of your voicemail.

Q. Will the TeleZapper “zap” calls from anyone other than telemarketers?

A. The TeleZapper is designed to “zap” calls made by predictive dialer computers by doing two things: first, by disconnecting predictive-dialed calls before you can be connected to a live telemarketer, and, second, by deleting your phone number from telemarketing computer lists. Whether the TeleZapper will affect computer-dialed calls from other sources depends on the type of computer equipment and how that equipment is being used. Therefore, it may also “zap” calls from businesses and organizations that use predictive dialing systems – not just telemarketers. Many companies and organizations do not rely entirely on computerized calling systems to reach you. Most have secondary means in place to contact or notify people with important information.

Furthermore, these organizations can always contact you by simply dialing your phone number manually. Manually dialed calls will not be zapped. As such, you can contact businesses and organizations to determine if they use predictive dialers and, if so, to ask that your phone number be manually dialed or that alternate means be used in order to contact you.



NOTE

- If you do not press any button within about 20 seconds during setup, the display returns to normal display and the setting remains unchanged.
- Press **OFF** at any time to exit programming.
- If you are dialing in pulse (rotary) mode from another phone sharing the same line, your TeleZapper feature must be set to either **BASIC** or **OFF**.
- With your TeleZapper feature set to **ADV** (Advanced), if your answering device ‘answers’ the call before you do, the answering device may not automatically stop once you've answered (if your answering device has an ‘Auto Stop’ feature). You would need to press **MAILBOX** on this answering device to return it to the idle, or sleep mode. With the TeleZapper set to **BRS** (Basic), your answering system's Auto Stop feature should function normally when you pick up a call.

OPERATING RANGE

This cordless telephone operates within the maximum power allowed by the FCC. Even so, this handset and base can communicate over only a certain distance — which can vary with the locations of the base and handset, the weather, and the construction of your home or office.

If you receive a call while you are out of range, the handset might not ring. If it does ring, the call might not connect when you press **TALK**. Move closer to the base, then press **TALK** to answer the call.

If you move out of range during a phone conversation, you might hear noise or interference. To improve reception, move closer to the base.

If you move out of range without pressing OFF, your phone will be left “off the hook.” To hang up properly, walk back into range, periodically pressing **OFF**.

Checking for Dial Tone

After the batteries are charged, connect the modular telephone cord between a live phone jack and the jack located on the bottom of the base unit. Pick up the handset and press **TALK**. You should hear a dial tone.

SETTINGS

Setting the Ringer Tone

You can select from four different handset ringer styles, or turn the ringer off and extend the battery life.

1. Make sure the handset is off.
2. Lift the handset and press **PROG/CHAN** to enter programming mode.
3. Press ◀ or ▶ until the screen displays **RINGER:** and the current setting.
4. Press **SELECT**. The current setting blinks, and you will hear a sample of the ring.
5. Press ◀ or ▶ to select **RINGER:1, 2, 3, 4,** or **OFF**.
6. Press **SELECT** to choose the displayed ringer setting.

Set the Dial Mode

If you have touch tone service, the phone is ready to use as soon as the batteries are charged.

If you have dial pulse (rotary) service, you'll need to change the dial mode.

1. Lift the handset and press **PROG/CHAN** on the handset to enter programming mode.

2. Press ◀ or ▶ until the screen displays **DIAL MODE:** and the currently selected mode.
3. Press **SELECT**. The current setting blinks.
4. Press ▶ to select **TONE** or **PULSE**.
5. Press **SELECT**, to save the displayed mode.

Setting Time and Date

If you subscribe to Caller ID service, the date and time will be set automatically with the first incoming call.

If you do not have Caller ID service, you can set the date and time manually.

1. Lift the handset and press **PROG/CHAN** to enter programming mode.
2. Press ◀ or ▶ until the screen displays **DATE/TIME**. Press **SELECT**.
3. The month flashes. Press ◀ or ▶ until the screen displays the correct month. Press **SELECT**.
4. The day flashes. Press ◀ or ▶ until the screen displays the correct day. Press **SELECT**.
5. The hour flashes. Press ◀ or ▶ until the screen displays the correct hour. Press **SELECT**.
6. The minutes flash. Press ◀ or ▶ until the screen displays the correct minutes. Press **SELECT**.
7. **AM** or **PM** flashes. Press ◀ or ▶ to choose between **AM** and **PM**. Press **SELECT**.

MAKING AND RECEIVING CALLS

The handset window has plastic film on it to protect it during shipment. Carefully peel off the film before using your phone.

1. To make a call, lift the handset and press **TALK**.

CONNECTING appears briefly and **PHONE ON** appears on the handset's display, and the **IN USE/CHARGING** indicator on the base flashes.

2. Dial the number. The number appears on the handset as you dial.

To end a call, place the handset on the base or press **OFF**.

You can also dial the number before you press **TALK**. If you make a mistake, press ◀ then enter the correct number.

When you receive a call, ****RINGING**** appears. To answer the call, lift the handset and press any button except **OFF**. **PHONE ON** appears on

NOTES

- If you do not press any button within about 20 seconds during setup, the display returns to normal and the setting remains unchanged.
- Press **OFF** at any time to exit programming.

the handset's display. To end a call, place the handset on the base or press **OFF**.

Selecting the Channel

The phone has 30 channels. If the call disconnects or you experience difficulty hearing the conversation during a call, press **PROG/CHAN** on the handset to select a different channel. **SEARCHING** appears as your phone searches for a clear channel.

Adjusting the Handset's Volume

To adjust the volume of the sound you hear through the handset during a call, press ◀ or ▶ on the handset until you reach the desired volume level. **VOLUME** appears on the handset. Once you set the volume level, the setting is maintained even after you hang up the phone. ☑

Using Redial

You can quickly dial the last number you dialed. Lift the handset and press **REDIAL**. Then press **TALK**. The phone dials the number. ☑

Press **REDIAL** twice while the telephone is not in use to clear the redial memory. **REDIAL EMPTY** appears on the display.

Answering a Call Waiting Call

Pressing **TALK/FLASH** during a call performs the electronic equivalent of a switchhook operation for special services, such as Call Waiting. For example, if you have Call Waiting, press **TALK/FLASH** to answer an incoming call without disconnecting the current call. Press **TALK/FLASH** again to return to the first call.

If you do not have any special phone services, pressing **TALK/FLASH** might disconnect the current call.

Using Hold

Press **HOLD** to place a call on hold. **HOLD** appears on the handset's display. While a call is on hold, you can temporarily place the handset on the base or use the other phone line without disconnecting the current call.

To release a line from hold and continue your conversation, press **TALK** or **HOLD**. You can also release a call from hold by lifting the handset if the handset is on the base.

Tone Services on a Pulse Line

Some special services require tone signals (such as bank-by-phone). If you have pulse dialing, you can still use these special tone services.

1. Dial the service's main number.
2. When the service answers, press ***STONE**. Any additional numbers you dial are sent as tone signals.

The phone's dial mode resets to pulse after you hang up'.

Paging

To send a page from the base to the handset or to locate the handset when the phone is not in use, press **PAGE** on the base. The handset beeps for about one minute. ****PAGING**** appears on the handset while the page sounds.

To stop the page, press **OFF** on the handset, place the handset on the base, or press **PAGE** on the base again.

The phone ringing when a call comes in while you are using the page feature interrupts the page process.

Using a Headset (not supplied)

You can make or answer calls with hands-free convenience using an optional headset that has a 3/32-inch (2.5-mm) plug. RadioShack has a variety of headsets available.

To connect the headset, gently flip open the rubber headset jack cover on the side of the handset. Then insert the headset's plug into the jack. ☑

With a headset connected, you can make or answer calls as usual using the keys on the handset. ◀ or ▶ on the handset also controls the headset's volume.

When you finish using the headset, disconnect it from the handset and close the rubber cover to protect the jack.

Display Screen Messages

Screen Displays:	When:
RINGING	there is a call coming in.
RINGER OFF	the ringer is off
CONNECTING	the handset is waiting for a dial tone.
PHONE ON	the handset is in use.
PAGING	the base is paging the handset.
HOLD	there is a call on hold.
BATTERY LOW	the battery is low
NEEDS RECHARGING	the battery needs charging

MEMORY DIALING

You can store up to 10 phone numbers and names in memory, and dial a stored number by entering its memory location number. Each number can be up to 16 digits, and each name can be up to 15 characters. ☑

Storing a Name and Number in Memory

1. Lift the handset and press **PROG/CHAN**. Then press ▶ until **MEM DIAL** appears.
2. Press **MEM. ENTER 0-9** appears.
3. Select an empty memory location (or the one you want to replace) by entering the location number (0-9). ☑



Adjusting the Handset's Volume

If you try to raise the volume when it is already at maximum, or lower it when it is at minimum, the setting will not change, and the phone sounds two short beeps.

Using Redial

- You can press **REDIAL** after pressing **TALK**.
- The redial memory holds up to 32 digits, including pause entries, so you can redial long distance numbers.

Using a Headset

- Connecting a headset disconnects the handset's earpiece and microphone.
- If you place the handset on the base to recharge while the headset is connected, be sure the handset seats properly.
- You can use a headset holder (available at your local RadioShack store) to hang the handset from your belt for greater convenience when using a headset.

Memory Dialing

- Press **OFF** at any time to exit memory dial mode. While setting, if you do not press any button within about 20 seconds, the normal display returns and no setting is stored.
- This cordless phone can store an additional 40 telephone numbers with names alphabetically in the directory. See "Telephone Directory" on Page 8.

Storing a Name and Number in Memory

If the location is not empty, the current entry is displayed. Press **OFF** to exit memory dial mode and start again, or follow the instructions to dial, edit or erase the current entry.

- If the selected location is empty, **ENTER NAME** appears.
- To enter a name, use the number keys.

Using the chart below, enter up to 15 characters for the name you're storing with the number. Use ◀ to backspace and make corrections; use ▶ to advance and add a space.

Key Pad Button	Number of Presses					
	1	2	3	4	5	6
1	1					
2	A	B	C	2		
3	D	E	F	3		
4	G	H	I	4		
5	J	K	L	5		
6	M	N	O	6		
7	P	Q	R	S	7	
8	T	U	V	8		
9	W	X	Y	Z	9	
0	0					
*	*					
#	&	'	,	-	.	#

- When you finish entering the name, press **SELECT** or **PROG/CHAN**. The screen displays **ENTER NUMBER**.
- Enter the telephone number. Use ◀ to backspace and make a correction. Press **REDIAL/PAUSE** to insert a pause in the dialing sequence. You can add more pause entries for a longer pause.
- Press **SELECT** or **PROG/CHAN** to store your entry. The screen displays **DISTINCT RINGS?** and the current setting.
- Press ◀ or ▶ to change the setting. Choose Y (Yes) if you wish the phone to alert you to calls from this number by changing to a distinctive ringing pattern after the first ring. Choose n (No) for a normal ringing pattern.
- Press **SELECT** or **PROG/CHAN** to confirm your selection. If you chose Y, **Y** is displayed with the memory entry.

Editing a Number/Name Stored in Memory

- Press **MEM**. The screen displays **ENTER 0-9**.
- Press the memory location key of the entry you wish to edit. If the location is empty, the handset sounds an error tone. Press another location key.
- When the screen displays the number you want to edit, press **SELECT**. Then press ◀ or ▶ until **EDIT** flashes.
- Press **SELECT**. The screen displays the name and number. The flashing cursor appears at the end of the name. Use ◀ or ▶ and the dial pad keys to edit the

name. Press **SELECT** again to edit the number. Press **SELECT** again to edit the Distinctive Ring setting.

- Press **SELECT** to save the edited information.

Deleting a Number/Name Stored in Memory

- Press **MEM**. The screen displays **ENTER 0-9**.
- Press the memory location key of the entry you wish to delete.
- When the screen displays the number you want to delete, press **SELECT**. Then press ▶ until **ERASE** flashes.
- Press **SELECT**. The screen displays **ERASE TO YES** and the number.
- Press ▶ until **YES** flashes.
- Press **SELECT**.

Dialing a Memory Number

- Press **MEM**. The screen displays **ENTER 0-9**.
 - Press the memory location key of the entry you wish to dial.
 - When the screen displays the number you want to dial, press **TALK**.
- OR**
- press **SELECT**. **DIRL** flashes.
- Press **SELECT**. The phone automatically dials the number.

Chain-Dialing Service Numbers

For quick recall of numbers for special services (such as bank-by-phone), store each group of numbers in its own memory location. Dial the service's main number first. Then, at the appropriate place in the call, press **MEM** and enter the number for the memory location where the additional information is stored. Press **TALK**.

TELEPHONE DIRECTORY

This cordless phone can store an additional 40 telephone numbers with names, each up to 16 digits long. Entries are stored alphabetically. For consistency with Caller ID entries, you may wish to enter last names first.

Storing a Number/Name in the Directory

- Lift the handset and press **PROG/CHAN**. The screen displays **DIRECTORY**.
- Press **SELECT**. The screen displays **ENTER NAME**.
- Using the chart below, enter up to 15 characters for the name you're storing with the number. Use ◀ to backspace

NOTE

- Press **OFF** at any time to exit directory.
- While setting, if you do not press any button within about 20 seconds, the normal display returns and no setting is stored.
- When memory is full the screen displays **MEMORY FULL**, an error tone sounds, and you will not be able to store a new number until you delete a stored number.

and make corrections; use ► to advance and add a space.

Key Pad Button	Number of Presses					
	1	2	3	4	5	6
1	1					
2	A	B	C	2		
3	D	E	F	3		
4	G	H	I	4		
5	J	K	L	5		
6	M	N	O	6		
7	P	Q	R	S	7	
8	T	U	V	8		
9	W	X	Y	Z	9	
0	0					
*	*					
#	&	'	,	-	.	#

- When you finish entering the name, press **SELECT** or **PROG/CHAN**. The screen displays **ENTER NUMBER**.
- Enter the telephone number. Use ◀ to backspace and make a correction. Press **REDIAL/PAUSE** to store a pause in the dialing sequence.

OR

Press **REDIAL/PAUSE** to display the last number dialed from this phone.

- Press **SELECT** or **PROG/CHAN**. The screen displays **DISTINCT RING?** and the current setting.
- Press ◀ or ► to change the setting. Choose Y (Yes) if you wish the phone to alert you to calls from this number by changing to a distinctive ringing pattern after the first ring. Choose n (No) for a normal ringing pattern.
- Press **SELECT** or **PROG/CHAN** to confirm your selection. If you chose Y, **Y** is displayed with the directory entry.

Editing a Number/Name Stored in the Directory

- Press ►. The screen displays **DIRECTORY**.
- Press ◀ or ► to scroll alphabetically through entries stored in memory.

OR

Press the dial pad key for the first letter of the entry you want to edit. If no alphabetical information is stored in the directory for that key, **NO DATA** appears. Press another key to try again.

- When the screen displays the number you want to edit, press **SELECT**. Then press ► until **EDIT** flashes.
- Press **SELECT**. The screen displays the name and number. The flashing cursor appears at the end of the name. Use ◀ or ► and the dial pad keys to edit the

name. Press **SELECT** again to edit the number. Press **SELECT** again to edit the Distinctive Ring setting.

- Press **SELECT** to save the edited information.

Deleting a Number/Name Stored in the Directory

- Press ►. The screen displays **DIRECTORY**.
- Press ◀ or ► to scroll alphabetically through entries stored in memory.

OR

Press the dial pad key for the first letter of the entry you want to delete.

- When the screen displays the number you want to delete, press **SELECT**. Then press ► until **ERASE** flashes.
- Press **SELECT**. The screen displays **ERASE NO YES** and the number. The current choice flashes.
- Press ◀ or ► until **YES** flashes.
- Press **SELECT**. You'll hear a long beep confirming the deletion.

Dialing a Number from the Directory

- Press ►. The screen displays **DIRECTORY**.
- Press ◀ or ► to scroll alphabetically through entries stored in memory.

OR

Press the dial pad key for the first letter of the entry you want to dial.

- When the screen displays the number you want to dial, press **SELECT**. **DIRL** flashes.
- Press **SELECT**. The phone automatically dials the number.

OR

When the screen displays the number you want to dial, press **TALK**.

CALLER ID OPERATION

About Call History

This phone assigns each incoming call a number from 1 to 99. The most recent call will have the highest number. When the memory is full, the oldest call information is deleted to make room for new incoming call information. You do not have to delete Caller ID records manually.

For each call that comes in, the screen displays the following information between the first and second rings:

- Your caller's name (15 letters are sent by your telephone company)
- The caller's area code and telephone number
- The time and date of the call

If you answer a call before the information appears on the screen, it will not be in the call history.

REVIEWING CALL HISTORY

The screen displays call information for about 20 seconds after it has been received and without any keys being pressed.

1. Press ◀ to view call history. ✎
2. Use ◀ and ▶ to scroll through records in call history. When you scroll past the last record, END OF LIST appears.

Deleting a Specific Call

1. Locate the record you want to delete from call history.
2. Press **SELECT** and then press ▶ until **ERASE** flashes.
3. Press **SELECT**. The screen displays **ERASE NO YES ALL** and the phone number. The current choice flashes.
4. Press ◀ or ▶ until **YES** flashes.
5. Press **SELECT**. You'll hear a long beep confirming the deletion.

Delete All Calls

1. While viewing call history, press **SELECT**. Then press ▶ until **ERASE** flashes.
2. Press **SELECT**. The screen displays **ERASE NO YES ALL**, and the phone number. The current choice flashes.
3. Press ▶ until **ALL** flashes. Then press **SELECT**. The screen displays **ERASE ALL NO YES**. The current choice flashes.
4. Press ◀ or ▶ until **YES** flashes.
5. Press **SELECT**. You will hear a long beep confirming the deletion.

Dialing a Displayed Number

1. Locate the record in call history that you want to dial.
2. If you wish to change how the number is dialed, repeatedly press #. The screen displays any alternate dialing sequences available for this call (area code + number; 1 + area code + number; number only; 1+ number).
3. Press **SELECT**. **DIRL** flashes.

Press **SELECT** when the number is correctly displayed for dialing.

OR

When the number is correctly displayed for dialing, press **TALK**.

Storing a Call History Record in the Directory

1. Locate the record in call history you want to store in the directory.
2. If you wish to change how the number is stored, repeatedly press #. The screen displays any alternate dialing sequences available for this call (area code + number; 1 + area code + number; number only; 1+ number).
3. Press **SELECT**, and then press ◀ and ▶ until **PMN** flashes.

The phone number will be displayed in the new format.

4. Press **SELECT** three times to store the call record in memory without editing. The screen displays **DISTINCT RING?** And the current setting.
5. Press ◀ and ▶ to change the setting. Choose **Y** (Yes) if you wish the phone to alert you to calls from this number by changing to a distinctive ringing pattern after the first ring. Choose **N** (No) for a normal ringing pattern.
6. Press **SELECT** or **PROG/CHAN** to confirm your selection. If you chose **Y**, **Y** is displayed with the directory entry.

DISPLAY SCREEN MESSAGES

Screen Displays:	When:
PRIVATE	the party calling is blocking name and (or) number information.
OUT OF AREA	your phone company is unable to receive information about the caller's name and (or) number.
L	the party calling is long distance.

TAD OPERATION

This TAD (Telephone Answering Device) gives you voice prompts (Audible Indicators) for feature operations and voice confirmations when you press a button or complete an operation.

SETTING DATE/TIME

1. Press **ANSWER ON/OFF** on the base to turn on the system. The button lights.
2. Press **TIME/SET**. The system announces the clock setting then announces, "To set Date and Time, press **TIME/SET**."
3. Press **TIME/SET**.
4. Press **SELECT** until the system announces the correct day of the week. Then press **TIME/SET**.

NOTES

- Press **OFF** at any time to exit call history.
- If there are no records the phone displays **CALL EMPTY**.
- The phone number will be displayed in the format it was received.

5. Press **SELECT** until the system announces the correct hour. Then press **TIME/SET**.
6. Press **SELECT** until the system announces the correct minutes (press and hold **SELECT** to advance by 10). Then press **TIME/SET**. The system announces the current clock setting.

RECORDING YOUR ANNOUNCEMENT

You can record up to two different announcements — one for normal answering and one for when you've set the system to play the announcement only.

- Use normal answering when you want the system to record callers' messages. Use Announce Only when you want your announcement to greet callers without accepting messages.
- If you choose not to record an announcement, the system answers with a pre-recorded announcement.
- The normal answering pre-recorded announcement says: "Hello. I'm unable to answer your call right now. Please leave your name, number and a message after the tone."

The Announce Only pre-recorded announcement says: "Hello, I'm unable to answer your call right now. Please call again. Thank you."

- By setting Announce Only to ON or OFF, you decide which announcement your callers will hear when the system answers a call (the system comes set for normal answering, with Announce Only turned off).

1. Press **MENU** until you hear "Set Outgoing Message."
2. Press **REC/MEMO**.

After you hear "Now recording" followed by a beep, speak toward the base to record an announcement up to 90 seconds long. 

3. Press **MAILBOX 1**, **MAILBOX 2** or **MAILBOX 3** to end the recording.

The system plays back your recorded message.

To review your announcement at any time, press **MENU** until you hear "Set Outgoing Message", then press **MAILBOX 1**, **MAILBOX 2** or **MAILBOX 3**.

To delete your announcement, press **DELETE** during announcement playback. The system will use the pre-recorded announcement until you record a new one.

SETTING UP YOUR ANSWERING SYSTEM

In addition to recording (setting) an outgoing message, you can set up other features one at a time, or you can set up a feature and then move on to set up another feature.

1. Make sure the answering system is on. The **ANSWER ON/OFF** button is lit when the system is on. If the button is not lit, press **ANSWER ON/OFF** to turn the system on.
2. Press **MENU** until the system announces the feature you want to set.
3. Press **SELECT** until the system announces the setting you want. Press **TIME/SET** to confirm your selection.
4. Press **MENU** to move on to the next feature, or press **MAILBOX 1**, **MAILBOX 2** or **MAILBOX 3** to exit setup.

"Set Security Code"

Use **SELECT** to choose the remote access code you will use to interact with the system's features and functions from a remote touch tone phone. You can select any two digit number from 40 to 99 as the new code. The default security code is 50.

"Set Audible Message Alert"

When the message alert is turned on, the base beeps once every 10 seconds if new messages have been received. Choose between On or Off. The default setting is Off.

"Set Announce Only"

When you set "Announce Only" to On, callers hear your announcement, but cannot leave a message. The default setting is Off.

"Set Base Ringer"

This option turns the base ringer On or Off. The default setting is On.

"Set Number of Rings"

This option allows you to choose the number of times the phone rings before the system answers the call. The choices are 2, 4, 6, or t5 (Toll Saver). The default setting is 4. 

PLAYING MESSAGES

The system automatically saves your messages until you delete them, and can store approximately 16 minutes of messages, memos, and announcements (up to a maximum of 99 messages). A message or memo can be up to 4 minutes long.

After the phone has recorded a message, its message-counter shows the total number of messages stored. If the message alert is on, and you have new messages, the indicator of the MAILBOX flashes and the TAD beeps every 10 seconds.

1. To play your messages, press **MAILBOX 1,2,or 3**, whichever one's LED

NOTES

Recording Your Announcement

If you have assigned different mailboxes to different people, be sure to tell callers in your announcement to press 1, 2, or 3 before speaking, so they can leave a message in the appropriate mailbox. Otherwise all messages will be recorded in mailbox 1

"Set Number of Rings"

- If you do not press any button within about 20 seconds during setting, the display returns to normal display and the setting saved.
- You can exit the feature setup mode at any time by pressing a **MAILBOX** button.
- When Toll Saver is chosen, the system answers after two rings when you have new messages and after four rings when there are no new messages.

is flashing or lit. The system announces the day and time it was received. While the message plays, the message window displays the number of the message. After playing the last message in a mailbox, the system announces "End of messages." If the system has less than five minutes of recording time left, it announces remaining time.

2. Repeatedly press **SKIP/QUICK** to skip to the next message or the desired message. Hold to speed up playback.
3. Repeatedly press **REPEAT/SLOW** until the beginning of the message you desire repeated is heard. Hold to slow down playback.
4. Press **MAILBOX** to stop playback. The MAILBOX button LED lights steady.

Window Displays:	To Indicate:
0	no messages
1-99	the total number of messages in all mailboxes, or current message number during playback
0-99 and F (alternate flash)	memory is full, or the total number of messages is 99
Counting 1 to 99	the duration of a memo recording or an announcement
99 flashing	the length of a recording is more than 99 seconds
1-8 steady for one second	the volume level when VOL ▼ or VOL ▲ is pressed
40-99	the current remote security code during setup
A	Announce Only mode
On or OF steady for one second	when any setting is set to On or OFF
CL	the clock needs to be set
--	the system is answering a call or is in remote operation mode
-- flashing	the system is in programing mode or initializing

Adjusting the TAD's Volume

To adjust the speaker's volume, repeatedly press **VOL ▼** or **▲** on the base. The volume setting from 1 (lowest) to 8 (highest) appears in the display.

Deleting Messages

To delete a message in a mailbox, press **DELETE** while it is playing. The phone announces "Message has been erased".

To delete all messages in a mailbox, press **DELETE**. The phone announces "Please select mail box". Press the desired mailbox button. The phone announces "All old messages have been erased." The number of the remaining messages appears on the display. The indicator on that MAILBOX

turns off.

☺ appears on the display when all messages from all three mailboxes have been deleted.

Call Screening/Intercept

1. Make sure the answering system is on, and set the message playback volume control above level 1 so you can hear the caller's message.
2. If you decide to take the call, press **TALK** on the handset.
3. If you pick up an extension phone during the announcement and the announcement does not stop right away, press and release the telephone switchhook.

RECORDING A MEMO

You can record a memo up to four minutes long, which is stored as an incoming message.

1. Press and release **REC/MEMO**.
2. Press **MAILBOX (1,2, or 3)** to select a mailbox for the memo. After the beep, speak toward the front of the base unit. The message window displays the length of your memo as you record it.
3. To stop recording, press **MAILBOX (1,2, or 3)**.

ANSWERING SYSTEM OPERATION ACCESS FROM A REMOTE LOCATION

1. Connect with the answering system by dialing your telephone number.
2. When the system answers, enter your Remote Access Code (preset to 50). The system beeps once and then announces the number of new messages.
3. Enter a remote command (see "Remote Access Commands"), or wait for the audible Voice Menu.
4. Press *** 0** to exit remote operation.

Voice Menu

The system has voice prompts to help you with remote operation. Press *** 5** to hear the menu while remotely connected to the answering system.

NOTE

- You cannot delete a message until it is reviewed.
- Deleted messages cannot be recovered.

REMOTE ACCESS COMMANDS

Function	Command
Play messages	Press #, then either 1, 2, or 3 for MAILBOX 1, 2, or 3 respectively.
Repeat a message	Press #, then 4 while the message is playing. Press #, then 4 twice to replay the previous message.
Skip a message	Press #, then 6 while the message is playing.
Stop	Press #, then 5 .
Save messages	Hang up.
Delete message	Press #, then 9 while the message is playing.
Review announcement	Press #, then 7 . System plays the announcement, then beeps.
Record announcement	Press *, then 7 . After the beep, record your announcement. Press #, then 5 to stop recording. The system plays back the announcement.
Record memo	Press *, then 8 , and then the mailbox number where you want the memo recorded. Press #, then 5 to stop recording.
End remote access call	Press *, then 0 .
Turn the system off	Press #, then 0 . The system announces, "Answering machine off." Press #, then 0 again to turn the system back on.
Turn the system on.	When the system is off it answers after 10 rings and announces, "Please enter your security code." Enter your remote security access code.

NOTE

Once you've entered Remote Access mode, if no key is pressed within 10 seconds, the system will provide the pre-recorded voice menu to help you. After the voice menu is heard, if no key is pressed within 20 seconds, the remote access call will automatically end.

TROUBLESHOOTING

We do not expect you to have any problems with your phone, but if you do, these suggestions might help.

If the phone doesn't work at all, check these items first:

- Make sure the AC adapter is plugged into an outlet not controlled by a wall switch. If so, make sure the switch is on.
- Make sure the telephone line cord is plugged firmly into the base unit and the modular jack.
- If the handset does not beep when you press **TALK**, the battery might need charging.
- Make sure the battery pack is installed correctly.
- If you have dial pulse (rotary) service on your phone line, make sure the dial mode is set to dial pulse (see "Checking for Dial Tone" on Page 6).
- Microwave appliances may cause interference with this phone. If you experience interference, move away from the microwave.

If the above suggestions don't solve the problem, try re-initializing the handset and base:

1. Disconnect the power to the base.
2. Remove the handset battery pack.
3. Wait a few minutes.
4. Connect the power to the base.
5. Insert the handset battery pack.
6. Put the handset in the base to re-initialize.

If you hear a two-beep signal when you try to use the handset:

- You might be out of range. Move closer to the base and try again.
- If moving closer to the base doesn't help, re-initialize the handset and base.

If the phone does not ring when you receive a call:

- Make sure the handset ringer is on.
- Make sure the telephone line cord is connected firmly to the base and the telephone jack.
- Make sure the AC adapter is plugged firmly into an outlet not controlled by a wall switch.
- You might be too far from the base; move closer.
- You might have too many extension phones on your telephone line to allow all of them to ring. Try unplugging some of them.

If you hear noise or interference when using the phone:

- You may be out of range. Move closer to the base.
- Press and release **PROG/CHAN** to change to another of the 30 channels available. If noise is exceptionally loud, move closer to the base before changing channels.
- Household appliances plugged into the same circuit as the base can sometimes cause interference. Try moving the appliance or the base to another outlet.
- Using the handset near household appliances (microwaves, computers, television, stereos, etc.) can sometimes cause interference. Move away from appliances while using the handset.
- The layout of your home or office might be limiting the operating range. Try moving the base to another location, preferably on an upper floor.
- If the buttons don't work, try placing the handset in the base for at least 15 seconds.

If you hear other calls while using your phone:

- Press **PROG/CHAN** to change to another channel.
- Disconnect the base from the modular jack and plug in a corded telephone. If you still hear other calls, the problem is probably in your wiring or local service. Call your local telephone service company.

If you lose a call after changing channels:

You were probably almost out of range. Move closer to the base before changing channels. Before placing another call, set the handset in the base for at least 15 seconds.

If you are unable to operate special telephone services or other equipment requiring touch tone signals:

If you have dial pulse (rotary) service, follow the directions under "Tone Services on a Pulse Line" on Page 7".

If messages are incomplete:

- When a caller leaves a very long message, part of it may be lost when the system disconnects the call after four minutes.
- When the caller pauses for more than seven seconds, the system stops recording and disconnects the call.
- When the system's memory becomes full during a message, the system stops recording and disconnects the call.

If you have difficulty hearing messages:

Check the volume setting.

If the system does not answer after the correct number of rings:

- Make sure that the answering system is on.
- If Toll Saver is on, the number of rings changes to two when you have new messages waiting.
- In some cases, the system may be affected by the ringing system used by the local telephone company.
- If the memory is full or the system is off, the system answers after 10 rings.

If CL appears in the Message Window:

You need to reset the clock.

If the system does not respond to commands from a remote phone:

- Make sure you are calling from a touch tone phone. When you dial a number, you should hear tones. If you hear clicks instead, the phone is not a touch tone telephone.
- The answering system may not detect the Remote Access Code while your announcement is playing. Try waiting until the announcement is over before entering the code.
- Make sure you enter your Remote Access Code correctly.
- There may be noise or interference on the phone line you are using. Press keys firmly.

If your outgoing announcement isn't clear:

- When you record your announcement, make sure you speak in a normal tone of voice, about nine inches from the base.
- Make sure there is no "background" noise (TV, music, etc.) while you are recording.

CARE

Keep the phone dry; if it gets wet, wipe it dry immediately. Use and store the phone only in normal temperature environments. Handle the phone carefully; do not drop it. Keep the phone away from dust and dirt, and wipe it with a damp cloth occasionally to keep it looking new.

SERVICE AND REPAIR

If your phone is not performing as it should, take it to your local RadioShack store for assistance. To locate your nearest RadioShack, use the store locator feature on RadioShack's website (www.radioshack.com), or call 1-800-The Shack (843-7422) and follow the menu options. Modifying or tampering with the phone's internal components can cause a malfunction and might invalidate its warranty and void your FCC authorization to operate it.

Limited One-Year Warranty

This product is warranted by RadioShack against manufacturing defects in material and workmanship under normal use for one (1) year from the date of purchase from RadioShack company-owned stores and authorized RadioShack franchisees and dealers. EXCEPT AS PROVIDED HEREIN, RadioShack MAKES NO EXPRESS WARRANTIES AND ANY IMPLIED WARRANTIES, INCLUDING THOSE OF MERCHANTABILITY AND FITNESS FOR A PARTICULAR PURPOSE, ARE LIMITED IN DURATION TO THE DURATION OF THE WRITTEN LIMITED WARRANTIES CONTAINED HEREIN. EXCEPT AS PROVIDED HEREIN, RadioShack SHALL HAVE NO LIABILITY OR RESPONSIBILITY TO CUSTOMER OR ANY OTHER PERSON OR ENTITY WITH RESPECT TO ANY LIABILITY, LOSS OR DAMAGE CAUSED DIRECTLY OR INDIRECTLY BY USE OR PERFORMANCE OF THE PRODUCT OR ARISING OUT OF ANY BREACH OF THIS WARRANTY, INCLUDING, BUT NOT LIMITED TO, ANY DAMAGES RESULTING FROM INCONVENIENCE, LOSS OF TIME, DATA, PROPERTY, REVENUE, OR PROFIT OR ANY INDIRECT, SPECIAL, INCIDENTAL, OR CONSEQUENTIAL DAMAGES, EVEN IF RadioShack HAS BEEN ADVISED OF THE POSSIBILITY OF SUCH DAMAGES.

Some states do not allow limitations on how long an implied warranty lasts or the exclusion or limitation of incidental or consequential damages, so the above limitations or exclusions may not apply to you.

In the event of a product defect during the warranty period, take the product and the RadioShack sales receipt as proof of purchase date to any RadioShack store. RadioShack will, at its option, unless otherwise provided by law: (a) correct the defect by product repair without charge for parts and labor; (b) replace the product with one of the same or similar design; or (c) refund the purchase price. All replaced parts and products, and products on which a refund is made, become the property of RadioShack. New or reconditioned parts and products may be used in the performance of warranty service. Repaired or replaced parts and products are warranted for the remainder of the original warranty period. You will be charged for repair or replacement of the product made after the expiration of the warranty period.

This warranty does not cover: (a) damage or failure caused by or attributable to acts of God, abuse, accident, misuse, improper or abnormal usage, failure to follow instructions, improper installation or maintenance, alteration, lightning or other incidence of excess voltage or current; (b) any repairs other than those provided by a RadioShack Authorized Service Facility; (c) consumables such as fuses or batteries; (d) cosmetic damage; (e) transportation, shipping or insurance costs; or (f) costs of product removal, installation, set-up service adjustment or reinstallation. This warranty gives you specific legal rights, and you may also have other rights which vary from state to state.

RadioShack Customer Relations, 200 Taylor Street, 6th Floor, Fort Worth, TX 76102

12/99

SPECIFICATIONS

Frequency Control.....Crystal controlled
PLL synthesizer

Transmit Frequency

Base 2411.15 — 2418.4MHz
Handset 912.75 — 917.10 MHz

Receive Frequency

Base 912.75 — 917.10 MHz
Handset 2411.15 — 2418.4 MHz
Channels 30 Channels

Power Requirements

Handset 400mAh Ni-Cd Battery Pack
Base 9V DC @ 400mA

Memory

Speed Dial10 Memory locations
(16 digits per location)
Directory40 Memory locations
(16 digits per location)
CIDAlphanumeric Display
(99 Memory locations)

OPTIONAL ACCESSORIES

RadioShack carries a full line of accessories for this cordless phone, including headsets, replacement batteries, and installation hardware. Accessories are available at your local RadioShack store or online at www.radioshack.com. Visit your local RadioShack store or www.radioshack.com for a more complete listing of available accessories.

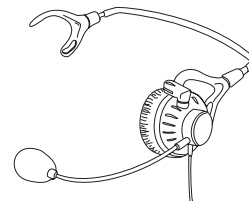

Headset