



Oricom eco Series



eco700 DECT Digital Cordless Telephone with Answering System



eco70 DECT Digital Cordless Telephone

USER GUIDE

Keep this user guide for future reference.

TABLE OF CONTENTS

WARNINGS AND SAFETY INFORMATION	1
GETTING STARTED	2
BASIC OPERATION	8
CALLER ID OPERATION	11
LNR FUNCTION (LAST NUMBER REDIAL)	13
PHONEBOOK	14
CORDLESS HANDSET OPERATION	15
ANSWERING MACHINE OPERATION (ECO700 ONLY)	19
REMOTE OPERATION (ECO700 ONLY)	23
CUSTOMER SUPPORT	25
APPENDIX	26

IMPORTANT

- Avoid exposure of this telephone to moisture or liquid.
 - To prevent electric shock, do not open the handset or base cabinet.
 - Avoid metallic contact (e.g. metal clips, keys) between the battery contacts and charging conductors.
 - There is a slight chance that the telephone could be damaged by an electrical storm. It is recommended that users unplug the phone from the mains supply and telephone socket during a storm.
 - Do not use the handset in an explosive hazard area such as where there is gas leaking.
 - Follow the local regulations regarding the disposal of your packing materials, exhausted batteries and used phone. Wherever possible, recycle those materials.
 - We advise that this phone should not be used near intensive care medical equipment or by persons with pacemakers.
 - Clean with a dry, soft, lint-free cloth. Never use cleaning agents, particularly aggressive solvents.
 - Because the phone works by sending radio signals between base station and handset, wearers of hearing aids may experience interference in the form of a humming noise.
 - Your phone can interfere with electrical equipment such as answering machines, TV and radio sets, clock radios and computers if placed too close. It is recommended that you position the base unit at least one metre from such appliances.
 - This telephone complies with applicable safety requirements for exposure to radio waves (EMR). The mean power of this telephone does not exceed 20mW limit at which point testing is required.
- The earpiece of the handset may attract small metal objects such as staples and pins. Care should be taken when placing the handset near these items.
 - This telephone is not designed for making emergency telephone calls when the mains power fails.
 - Always have a corded phone available to be able to make and receive calls to emergency services if the mains power fails.
 - Do not use your telephone during an electrical storm thunderstorm as it is possible to get an electric shock.
 - Refer to information contained in White pages directory.
 - This phone is designed for connection to a PSTN telephone line or an analogue extension port of a PBX system. If you connect this device to a digital extension of a PBX, damage may result to the PBX.



CAUTION

Use only the mains adaptors supplied with this product. Incorrect adaptor polarity or voltage can seriously damage the unit.

Adaptor for base unit:

eco70

Input: 100-240VAC 50/60Hz 200mA

Output: 6VDC 300mA

eco700

Input: 100-240VAC 50/60Hz 200mA

Output: 6VDC 500mA

eco70&700 charger (eco7050):

Input: 100-240VAC 200mA;

Output: 7.5VDC 100mA;

2 GETTING STARTED

Installation and Charger

1. Connect the mains adaptor (supplied) to the socket on the back of the base unit and to the wall mains supply.
2. Connect the telephone cord to the phone socket on the back of the base unit and into the wall phone socket.
3. Insert 2 rechargeable Ni-MH AAA batteries (included), observing the correct polarity, into the battery compartment on the handset. Slide the battery door firmly into place.
4. Place the handset on the charging cradle and charge the batteries for a full 14 hours before using it for the first time.

Note:

It may take some time for the cordless handset to power up, and it may get warm during initial charge. This is normal.

Tip!

It is good practice to put the cordless handset on the charging cradle when it is not in use to ensure that the handset is always fully charged.



WARNING

DO NOT USE STANDARD/ALKALINE BATTERIES IN THIS PRODUCT, AS THERE IS A RISK OF EXPLOSION AND/OR INJURY. USE ONLY NI-MH RECHARGEABLE BATTERIES AS SPECIFIED IN THIS USER GUIDE. CONTACT ORICOM FOR REPLACEMENT BATTERIES. RISK OF EXPLOSION IF BATTERY IS REPLACED BY AN INCORRECT TYPE.

Never use non-rechargeable batteries. Use recommended type supplied with this product.

- Never use alkaline or lithium batteries.
- Do not dispose of the batteries in a fire, as they can explode.
- Do not open or mutilate the battery. Released electrolyte is corrosive and can cause damage to the eyes or skin. It can be toxic if swallowed.
- Avoid contact with metal objects when handling the battery. These objects could short out the batteries or cause the conductor to overheat resulting in burns.
- Do not attempt to recharge the battery cell by heating it. Sudden release of battery electrolyte can cause burns or irritation to the eyes or skin.
- Observe the proper polarity, or direction, of any battery. Reverse insertion of the battery cell can result in leakage or explosion.
- Remove the batteries if you do not plan to use the product for several months at a time.
- Follow the local regulations regarding the disposal of your packing materials, exhausted batteries and used phone. Wherever possible, recycle those materials.

Pack contents

Depending on the model you have purchased this pack should contain the following items:

If any of these are missing, please contact Oricom directly.

	eco70/700-1	eco70/700-2
Base units	1	1
Cordless handsets	1	2
Charging cradle and power adaptor	0	1
Power adaptors	1	1
Line cord	1	1
User guide	1	1
Handset Rechargeable AAA Ni-MH Batteries (1.2V 500mAh)	2	4

Purchasing additional handsets

You may expand your eco70/700 by adding more handsets (eco7050). These can be purchased separately from the retailer where you purchased the product, or directly from Oricom (Australia). The eco70/700 can accommodate a total of 5 cordless handsets.

IMPORTANT: DO YOU HAVE BROADBAND/ADSL?

If you do, you must connect an in line filter (not supplied) between the telephone socket and your eco70/700 base to ensure that your broadband and eco70/700 will work properly. If you do not install the filter you will experience interference on the eco70/700 and your Broadband may suffer dropouts. Please refer to the user guide of the in line filter for installation.

4 GETTING STARTED

Your cordless handset

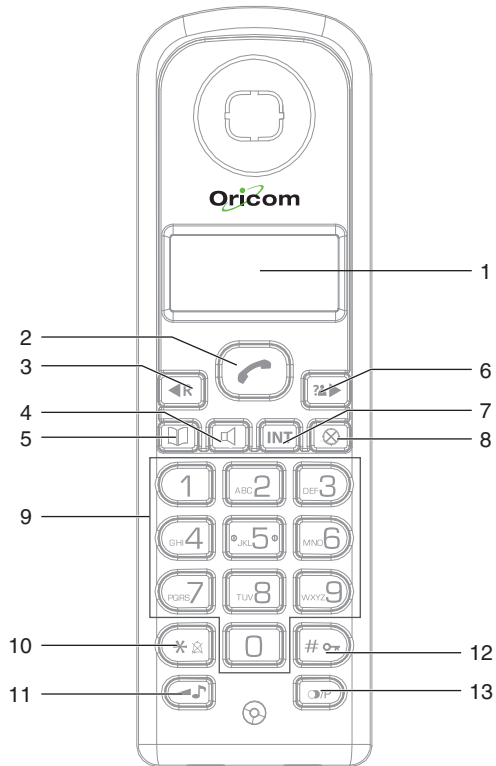

- 1 LCD Display
- 2 Talk
- 3 Left / Recall / Dial mode
- 4 Handsfree
- 5 Phonebook
- 6 Right / CID (Caller ID)
- 7 Intercom
- 8 Delete / Mute
- 9 Numeric keys
- 10 * / Ringer Off (On)
- 11 Ringer Melody / Ringer Volume / Receiver Volume
- 12 # / Keypad lock
- 13 LNR (Last Number Redial) / Pause / Long (Short) flash

Answering machine (eco700)

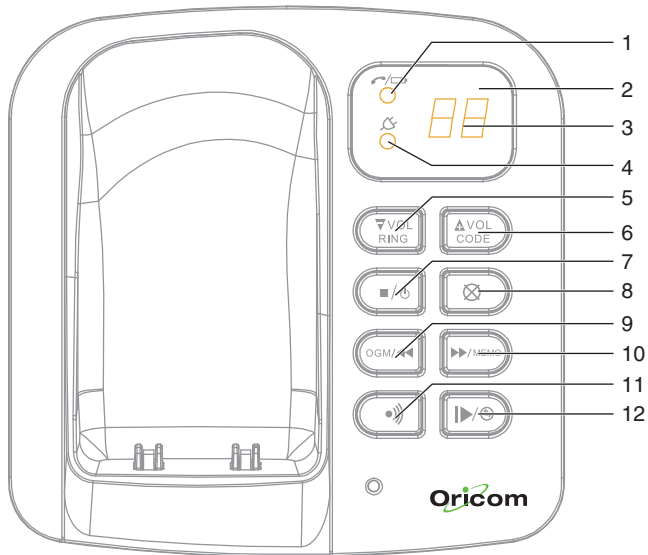

- 1 Talk/Charging state indication
- 2 LCD Display
- 3 Number or Character indication
- 4 Power supply indication
- 5 Speaker Volume down / Ring
- 6 Speaker Volume Up / Code
- 7 Power On/Off / Stop
- 8 Delete
- 9 OGM / Rewind
- 10 Fast Forward / MEMO
- 11 Page
- 12 Play / Pause / Clock

6 GETTING STARTED

eco700

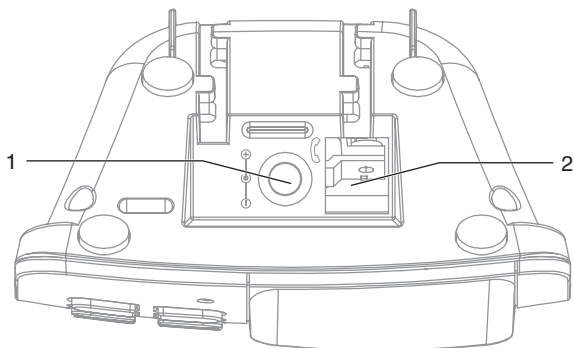

1 Connected with DC adaptor





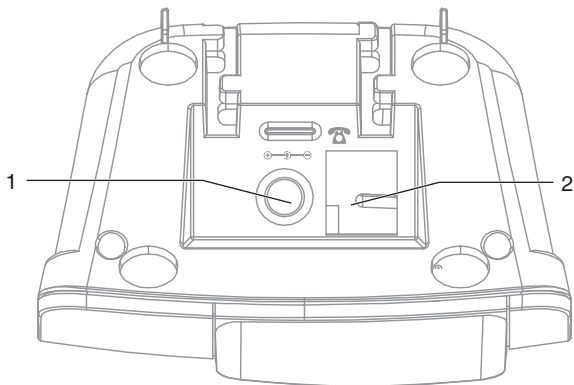





2 Connected with telephone cord

eco70



Understanding the cordless handset display



-  **Left Arrow / Phonebook records are being reviewed**
-  **Battery level (3 bars fully charged)**
-  **Ringer is turned off**
-  **Speakerphone on**
-  **Keypad lock**
-  **Connected to telephone line**
Flashes when there is an incoming call
X appears: microphone muted
-  **Caller display**
-  **Antenna in range / out of range**
-  **Intercom call to another handset**
-  **Right Arrow / Message waiting**

8 BASIC OPERATION

During standby

Note:

If the power is not connected to the base unit.
The cordless handset **CANNOT** operate.

Cordless handset's LCD display

HANDSET 1 : Handset number

 : Current battery level



 : A constant signal icon indicates the cordless handset is linked to the base unit. When signal icon is flashing the handset needs to be re-registered.





Note:

The signal icon will also flash if the handset is out of range.



Answering an incoming call

When there is an incoming call, the phone rings and  flashes on the display. If a CID record is received,  flashes and the caller information is displayed.



1. Press [] key to answer the call.
2. Press [] key again to end the call.

Making an external call

Normal dialling

1. Press [] key.
2. Enter a telephone number. If you enter more than 12 digits, you only see the last 12 digits on the display.
3. Press [] key to end the call.

Pre-dialling

1. Enter a telephone number.
2. When necessary, press [] to erase the digit individually.
3. Press [] key to dial.
4. Press [] key to end the call.

Mute feature

Place a call on hold so that the caller will NOT be able to hear you but you can still hear the caller.

During talking mode,

1. Press [⊗] key on the handset to mute the call,  is shown on the display.
2. Press [⊗] key again to resume the call.

Handset range

Your eco70/700 handset has a range of up to 300 metres outdoors and up to 50 metres indoors, in ideal conditions.

If you carry the handset too far away from the base, you may go out of communication range and the antenna icon will flash on the display.

If you are already on a call and move out of range, the call quality will degrade as the range limit is reached and the call may be disconnected. You will need to move closer to the base to be able to continue the call and make any further calls.

Checking the signal strength

The signal icon  displays the link status between your handset and the base unit. A steady icon means your handset and the base unit are linked. A flashing icon means your handset and the base unit are not linked.

If you move too far away from the base unit while you are on the phone, you will hear warning tones notifying you that your handset is almost out of range – lost link. Take your handset closer to the base unit or your call may be cut off shortly after the warning

Note:

If your handset has lost the link with the base, you will not be able to make or receive calls. You will also not be able to carry out many of the phone functions and features.

IMPORTANT NOTE:

Emergency Call. This telephone is not designed for making emergency telephone calls when the power fails. Alternative arrangements should be made for access to emergency services.

10 BASIC OPERATION

Recall selection



You can use the Recall button on your telephone when using your network operator's services such as call waiting etc. A subscription may apply for these services. Contact your network operator for more information. If this is not working correctly, change the setting using the instruction below:

Selecting recall duration:

1. Press and hold [/P] for 3 seconds.
2. The display will show "L" or "S"
(L: New Zealand ; S: Australia).



Handsfree mode

During talking or standby mode,

1. Press [] key to switch to speakerphone mode.
2. Press [] key again to cancel this feature.

Volume adjustment

During standby mode adjust the handset ringer volume.

1. Press [] key.
2. Press [ R] or [] key to adjust the handset volume level, there are 5 volume levels and Volume off for selection.

During handset talking mode adjust the handset receiver volume.

Press [] key repeatedly to adjust the handset volume level (5 volume levels).



If you subscribe to your telephone operators service (charges may apply), numbers of the incoming calls will be displayed on the screen and stored in the call log (please consult your telephone service provider for details).

The eco70/700 series can store the last 20 calls including: the record number, date/time, and phone number (up to 23 digits for the cordless handset).

When you have new/unanswered calls,  flashes on the cordless handset. If a call has been answered, then the call is set to old call.

Call waiting (Australia only)

You can use the recall function to answer a second call while you are on the phone. However this service needs to be turned on. For example, to turn on Telstra's Call Waiting service:

1. Press [] on the cordless handset to wait for dial tone then press [*] [4] [3] [#].
2. You will hear a service tone then press [] again.

Take two different calls at the same time

During a call, you will hear two loud beeps periodically to notify you of another incoming call. If you wish to answer this call,

1. Press [] key. You will hear a dial tone.
2. Press [2] to put the current call on hold and talk with the second caller.
3. Repeat steps 1-2 to swap between the two callers.



Review Caller ID records

During standby mode,

1. Press [] key to display the latest call. The following will appear on the display.



If the list is empty, "NO" is shown on the display.

2. Press [] key to view the data and time of the CID.
3. Press [] key to view to the previous call.
Press [] key to view the next call.

Only when the network sends the time/date together with the telephone number! On some networks with caller ID, time and date will not be displayed.

12 CALLER ID OPERATION



Store a CID number

You can save a CID record into the Phonebook/Direct memory provided that it contains a valid phone number and the Phonebook/Direct memory is not full.

While you are viewing the CID record that you wish to save,

1. Press and hold [] key for about 2 seconds. The following will appear on the display.



2. The space after the last digit of the CID will blink, and press the numeric keys to edit the CID number and then press [] key to confirm.
3. Press the memory location no. that you want to store the number. It will then give a beep to confirm that the storage is successful.
4. Press [] key again to confirm and go back to standby mode.

The record is now saved into the phonebook. Then it goes back to the call log.

Delete CID record(s)

While you are viewing the CID record that you wish to delete,



Press and hold [] key for about 3 seconds.

Note:

If there are no more CID records, a message "NO" is displayed.

Calling a number from the CID records



When you are viewing the CID records,

1. Press [] or [ R] key to scroll to desired number.
2. Press [] key. The number will be dialled automatically.

Redial the last number

Your cordless handset stores the last 3 external numbers dialed, up to 24 digits per number. If the number exceeds 24 digits, the last 24 digits will be stored to memory.

During standby mode,

1. Press [/P] key.
2. When necessary, press [/P] key again until you have selected your desired number.
3. Press [] key to dial.

Or



1. Press [] key.
2. Press [/P] key to redial the last number.

Store the last number dialed

While you are viewing a previously dialed number that you wish to save,

1. Press and hold [] key for about 2 seconds. The following will appear on the display.



2. The space after the last digit of the Redial number will blink, and you can press numeric keys to edit the Redial number. Then press [] key to confirm.
3. Press the numeric keys to edit the memory location (0-9) where you want to store the number. You will hear a confirm beep.
4. Press [] key again to confirm and go back to standby mode.

The record is now saved into the phonebook. Then it goes back to the call log.

Delete last number dialed

While you are viewing a previously dialed number that you wish to delete,

Press and hold [] key for about 3 seconds.

Note:





If there are no more LNR records, a message "NO" is displayed.

14 PHONEBOOK

Add new records

You can store up to 10 phonebook records in each handset. Each record can contain up to 24 digits per number.

During standby mode,

1. Press and hold [] key until the  icon appears on the display.
2. Press the numeric keys to enter the telephone number. If you made a mistake, press [] key to edit it. Press and hold [] key to delete the entire number.
3. Press [] key to confirm.
4. Press the numeric keys to enter the memory location (0-9) where you want to store the number.
5. You will hear a confirmation beep.

The record is now saved into the Phonebook. Then it goes back to standby mode. Repeat step 1 to 5 to add another record.

Review / Edit / Dial stored Phonebook records

During standby mode,

1. Press [] key. The following will appear on the display.





2. Press the numeric keys to view the stored records.
3. Press [] key to dial the number.

While you are viewing the record that you wish to edit,

1. Press and hold [] key. The following will appear on the display. The space after the last digit will blink.



2. Press [] key to erase the last digit, or press and hold [] key to erase the entire digits.
3. Press [] key to confirm.

Voice mail indication – network service

Note:

Voice Mail Indication Service. Requires subscription with your network service provider.

Voice mail indication is a visual voice mail alert. On this phone, you will see an envelope icon when there is a voice mail waiting in your service providers mailbox.

Retrieving Voice mail(s)

To retrieve your voice mail(s), consult your service provider.

Clearing the Voice mail indicator





After checking your voice mail(s), the voice mail indicator icon will be cleared automatically after receiving a signal from the network. You can clear the voice mail indicator icon manually if it fails to reset.

1. Remove the batteries of the handset unit. Wait for 30 seconds. Insert batteries again, the voice mail indicator will be cleared.

Handset ringer adjustment





Handset ringer melody

During standby mode,

1. Press and hold [] key.
2. Press [ R] or [] key to select the melody option (1 to 9 for adjustment).
3. Press [] key to confirm.

Handset ringer volume

During standby mode,

1. Press [] key. Display shows the current volume level.
2. Press [ R] or [] key to select the volume level.
There are 5 levels for adjustment: 1 (lowest) to 5 (highest) and Volume off (the [] icon will be shown on the display).
3. Press [] key again to confirm.

Handset ringer On / Off

During standby mode, press and hold [* ] key to switch between ringer On/Off.



 appears whenever the ringer is Off.

16 CORDLESS HANDSET OPERATION

Multi-handset Operation

Your eco70/700 series phone can have up to 5 handsets registered to the base unit. Each handset has its own number HS-1, HS-2, HS-3, HS-4 and HS-5, shown on the left-hand side of the display. With 2 or more handsets you can:

- Make intercom calls while on an external call
- Switch between an external call and intercom call
- Transfer an external call from one handset to another
- Set a 3-way conference call between yourself, an external call and intercom call

Note:

- A maximum of 1x external call and 2x intercom calls can take place at the same time.
- If you make an external call + another handset is on line = result in a busy tone.
- You can make an intercom call when the other handset is in progress.

Call transfer between cordless handsets

During external call,

1. Press [INT] key. The following will appear on the display.



2. Key the handset number (2, 3, 4 or 5) you wish to transfer.
3. Press [] key to exit Intercom mode and return to standby mode.

Conference calls

This function allows 3 parties (yourself + external call + intercom call) to be connected at the same time.

During external call,



1. Press [INT] key. The following will appear on the display.



2. Key the handset number (2, 3, 4, 5) you wish to invite to the conference.
3. Then you can have an intercom call with HS-x.
4. At this moment, you can press and hold [INT] key for 3 seconds to go to 3-way conference call.

Cordless handset keypad lock

During standby mode,

1. Press and hold [# ] key to lock the keypad.
2. To release keypad lock, press and hold [# ] key for 3 seconds.

Note:

When the keypad is locked, [] key and [INT] key can be used to answer an external or intercom call.

Registration

Register new handsets on the eco70/700 base

The handsets which come in the same pack are already registered to the base. If you buy new handsets. You need to register them before use.

1. Charge the batteries (for 14 hours).
2. Register the handset (to the base unit).





the operation is different in eco70 and eco700.

In eco70, we need to set the base unit in registration mode by resetting the base power.

In eco700, we can set the base in registration mode by pressing and holding the base [] for 10s

Each base can register up to 5 handsets.

During standby mode,

1. Press and hold the [] key for 3 seconds until both the [] and [] icons flash, then press and hold the [] key for 3 seconds. The following will appear on the display.





2. Press 1 and the handset begins to search for the base.
3. Enter the base pin code (0000). If the pin is wrong, the handset will restart searching for the base.
4. When the handset is registered, it will show “HS” followed by the handset number.

Note:

If the base is full and cannot add any more handsets, you will hear a tone. See the next section to remove a handset.

Remove handsets

During standby mode,

1. Press and hold the [] key for 3 seconds, then press and hold the [] key for 3 seconds.
2. Enter the default value 0000. If the pin is wrong, the handset will go back to standby.
3. Press the numeric keys (1-5) to enter the handset number you want to remove.
4. The unit will go back to standby if the removal is successful.

Note:

You can only remove other handsets in your system but you are not able to remove the handset you are using.

18 ANSWERING MACHINE OPERATION (ECO700 ONLY)

The base has a built-in digital answering machine with a recording capacity of 11 min. The answering machine can be operated remotely and features the possibility of recording two outgoing messages (OGM 1 and OGM 2) (maximum of 2 min).

There are 2 possibilities:

- With OGM 1, the caller has the possibility to leave a message
- With OGM 2, only the outgoing message is given without the caller having the opportunity to leave a message

The max. recording time for each incoming message = 3 min.

An internal voice will state various information, such as day and time of the call. The language of the internal voice is stated on the packaging!

LED Display

The LED display on the base indicates how many messages you have received. When there are new messages, the 2x 7 segment LED display on the base will blink and indicate the amount of new messages. If the answering machine is switched off, the LED display does not light up. "FL" will be shown on the display when the internal memory is full and no new messages can be recorded.

Outgoing Messages

Two outgoing messages of 2 minutes can be recorded (OGM1 and OGM2).

- Outgoing message 1 for the answering function and possibility for callers to leave a message.
- Outgoing message 2 for the answering function without allowing callers to leave a messages on the machine.

Recording outgoing messages (OGM 1 or OGM 2)

- Press and hold the [■ / ⏻] key to select the OGM.
- Press the [OGM / ⏪] key for two seconds.
- Record the outgoing message after the beep.
- Press the Stop key [■ / ⏻] to stop recording.

Playback the Outgoing Message

To check the outgoing message now set:

- Press the [OGM / ⏪] key.

Note:

- It is only possible to select an outgoing message if the answering machine is turned on.
- If the memory is full, only outgoing message 2 can be selected (only answering without recording messages).

Erasing the Outgoing Message

Erase the outgoing message as follows:

- Select the desired outgoing message by pressing and hold the [■/⏪] key.
- Press the [OGM/◀◀] key to play the outgoing message.
- Keep pressing the [⊗] key when the OGM is played back.

Turning Answering Machine On/Off

If the answering machine is on, the 2x7 segment LED display will light up and the machine will automatically pick up the line after a number of rings (see “Setting number of Rings”).

- Press the [■/⏪] key to switch on the answering machine. The 2x7 segment LED will be turned on.
- Press the [■/⏪] key again to switch off the answering machine. The 2x7 segment LED will be turned off.

Note:

- Even if the answering machine is off, the machine will automatically pick up after 16 rings in order to enable remote activation (see “Remote Operation”).

Setting number of Rings

The number of rings after which the answering machine will answer calls can be set from 2 – 9 and TS (Toll saver). The standard setting is 3 rings. In Toll saver mode, the machine will answer after 5 rings if there are no new messages, and after 2 rings if there are new messages. If there are no new messages and you call your machine to check your messages remotely (See “Remote Operation”), you can hang up after the 2nd ring. You do not need to pay connection fees and you know that you do not have any new messages.

- Briefly press the [▼VOL RING] key. The display will show the current numbers of rings.
- Press the [▼VOL RING] key for 2 secs to set the number of ringing tones.
- Press the [OGM/◀◀] or [▶▶/MEMO] key to change the current number of rings.
- Confirm the setting by pressing the [▼VOL RING] key.
- If you do not press any keys for 3 seconds, the machine will revert back to the answering machine menu, without changing the settings.
- If there is a loss of power in the base, the number of rings will revert to 5.

20 ANSWERING MACHINE OPERATION (ECO700 ONLY)

Note:

- If you do not press any keys for 3 seconds, the machine will revert back to the answering machine menu, without changing the settings.

Checking number of Rings

- Press the [Δ VOL CODE] key briefly.
- The display will show the number of rings set.

Programming the VIP Code

The VIP code is a 3-digit code used to operate the machine remotely (see Remote Operation). The VIP code is set to "321" by default.

Changing the VIP Code

- Keep the [Δ VOL CODE] key pressed down for 2 secs to change the VIP code.
- The first digit of the VIP code is displayed blinking on the screen.
- Press [OGM/◀◀] or [▶▶/MEMO] keys to set the first number of the VIP code.
- Press the [Δ VOL CODE] key to confirm the first number. The display will show the current set 2nd digit of the VIP code.

- Press [OGM/◀◀] or [▶▶/MEMO] keys to set the second digit of the VIP code.
- Press the [Δ VOL CODE] key to confirm the second number. The display will show the current set 3rd digit of the VIP code.
- Press [OGM/◀◀] or [▶▶/MEMO] keys to set the third digit of the VIP code.
- Press the [Δ VOL CODE] key to confirm the VIP code. You will hear a long beep. The new code will be displayed digit by digit.

Note:

- If you do not press any keys for 8 seconds, the previous VIP code is saved and the machine automatically exits the VIP setting mode.

Checking the VIP Code

- Press the [Δ VOL CODE] key to show the VIP code. The display will show the VIP code digit by digit.

Programming the Date/Time

- Press and hold the [\blacktriangleright /Ⓢ] button for 2 seconds, it will first play the current Date/Time.
- Then, a short beep to start set date, prompt "Set day", pause then prompt current day. Press [OGM/◀◀] or [▶▶/MEMO] to select days.

- Press [▶/⊙] button to confirm setting and jump to next, it will prompt "Set hour", pause then prompt current hour in 24 hours format. Press [OGM/◀◀] or [▶▶/MEMO] to select hours.
- Press [▶/⊙] button to confirm setting and jump to next, it will prompt "Set minute", pause then prompt current minute. User would press [OGM/◀◀] or [▶▶/MEMO] to select minutes
- Press [▶/⊙] button to confirm setting, it will prompt the newly set day, hours and minute then back to standby or off mode.

Operation

If a call is received and the answering machine is turned on, the answering machine will automatically pick up the line after the set number of rings. If

- Outgoing message 1 has been selected, it will be played. After the outgoing message, a beep will be heard and the caller can leave a message (of a max. 2 minutes).
- Outgoing message 2 has been selected, it will be played. After the beep, the line will automatically be disconnected. The caller does not have the possibility to leave a message.

Note:

- If, during pick-up, nothing is said for 8 seconds, the line will be automatically disconnected.
- The 2x7 segment LED will flash and alert the user that a new message is recorded.

Recording a Memo

You can record memos. These memos are considered an incoming message that can be picked up later by the user. The max. recording time for a memo is 3 minutes.

- Press the [▶▶/MEMO] key for 2 seconds. After the beep, say your memo.
- Press the Stop [■/⏏] key to stop recording.

Playback of Incoming Messages and Memos

- Press the [▶/⊙] key to play the messages and memos.
- The messages are played one at a time. If there are new messages, only the new messages (those that have not been heard) are played.
- During playback, you can:
 - go to the beginning of the current message by pressing the [OGM/◀◀] key once.

22 ANSWERING MACHINE OPERATION (ECO700 ONLY)

- go to the previous message by pressing the [OGM/◀◀] key twice.
- stop playback by pressing the Stop [■/⏏] key.
- interrupt playback by pressing the Pause key [|▶/⏸]. Press the play [|▶/▶] key again to restart playback.
- go to the next message by pressing the [▶▶/MEMO] key.

Erasing Messages

Erasing Messages One at a Time during Playback

Start message playback as explained above.

- When the message to be erased starts playing, press the delete key [✕] for 2 secs
- The display will show "dL".
- Press the delete key [✕] again to confirm.

Erase all messages

One can also erase all heard messages at one time. This erases only the messages that have already been heard. New messages are not erased.

- Press the delete key [✕] for 2 secs.
- The display will show "dL".
- Press the delete key [✕] again to confirm.

Memory Full

If the memory is full, "FL" will flash on the display. If the answering machine is turned on and a call comes in, the machine will automatically play OGM 2 (answering machine function without recorded caller message).

- Erase all the messages after listening to them.
- The memory is free again.

The answering machine can only be operated remotely using a touch-tone phone (DTMF tone selection system).

- Call your machine.
- The answering machine picks up the line, you hear the outgoing message and a beep.
- After the beep, slowly dial the VIP code (default 321).
- You will hear two short beeps for confirmation.
- Enter the next codes to use the desired function:

Listening to Messages

- Press [2] (listen to messages). The answer machine will play the messages.

During playback, you have the following options:

- Press [2] to stop playback.
- Press [2] to restart playback.
- Press [3] to go to the next message.
- Press [11] to go to the previous message.
- Press [1] to repeat the current message.
- Press [6] to stop playback.
- Press [7] to erase the current message.

Erasing All Old Messages

After listening to all messages, press [0] to erase all messages.

Playing Outgoing Message

- Press [4] to play the current outgoing message.

Recording Outgoing Message

- Press [9] to select OGM 1 or OGM 2.
- Press [5] to start recording
- A beep will indicate that you can start recording.
- Say your message.
- Press [6] to stop recording.

Turning Answering Machine On/Off

- Press the [9] key to switch on the answering machine.
- Press the [8] key to turn off the answering machine.

Ending Remote Operation

If you want to end remote operation, press [6].

24 REMOTE OPERATION (ECO700 ONLY)

Turning answering machine on remotely

If the answering machine is switched off, you can turn it on remotely.

- Call your machine.
- The machine will pick up automatically after 16 rings and play outgoing message 2.
- After the beep tone dial the VIP code (default 321) slowly during the message plays.
- Press the '9' key. A long beep will be heard.
- Press [6] to stop operation.

Keys on remote phone keypad	Corresponding button on answer machine
1	RW
2	Play/Pause
3	FF
4	OGM playback
5	OGM recording (press 'Stop' to stop)
6	Stop
7	Delete current message
8	Answering off
9	Answering on
0	Delete all old messages
*	Skip announcement
#	Memo Recording

If you feel this product is not working correctly please consult the user guide and ensure that you are using the product in accordance with the instructions. Remove all extra telephone equipment and connect only this telephone directly to the telephone socket. If the fault is still present, connect another telephone (if available) to the telephone socket. The results will show you whether the fault lies with this unit or with the telephone line.

If the product is working correctly the fault is on the telephone line. Please contact your network operator for assistance.

To order spare parts additional handsets, replacement batteries and in case of any technical issues you may have with this product please consult our website for further information or send us an email for a prompt response to your enquiry.

In the unlikely event of a fault developing, please contact us for assistance. If the product is then found to be faulty you will be asked to return it directly to us with a copy of the purchase receipt.

26 APPENDIX

Troubleshooting

Problem	Possible cause(s)	Solution(s)
No dial tone on the cordless handset.	<ol style="list-style-type: none">1. The base unit is not properly connected.2. Too far from the base unit.3. Battery charge is low.4. Incorrect battery polarity.5. Re-register handset.	<ol style="list-style-type: none">1. Check CONNECTION to power and telephone line.2. Move handset CLOSER to base unit.3. CHARGE battery.4. RE-INSERT batteries and check + and -.5. Handset not registered.
Antenna symbol is flashing.	<ol style="list-style-type: none">1. The handset is not registered. If the handset is unregistered, it displays UNREGISTERED.2. The handset is out of range.3. The product is not properly connected.	<ol style="list-style-type: none">1. REGISTER the handset.2. Move CLOSER to the base unit.3. Check power CONNECTION to the base.
No beep when the cordless handset is placed on the charger.	<ol style="list-style-type: none">1. The handset is not placed properly on the charger.2. Charging contacts are dirty.3. No power connection to base unit.4. The handset's power is turned off.	<ol style="list-style-type: none">1. Lift handset off the charger carefully and REPOSITION correctly.2. CLEAN charging contacts with a clean and dry cloth.3. Check power CONNECTION to the base.4. CHECK batteries.
Handset charged for 24 hours but Battery icon remains empty.	<ol style="list-style-type: none">1. Handset battery is defective or faulty.2. Handset is not placed properly on the charger.3. Battery installed incorrectly.4. The product is not properly connected.	<ol style="list-style-type: none">1. REPLACE with new AAA rechargeable Ni-MH batteries.2. CHECK to make sure the battery icon is scrolling.3. RE-INSERT batteries and check + and -.4. Check power CONNECTION to the base.
No symbol on the display.	<ol style="list-style-type: none">1. Battery is empty.2. The product is not properly connected.	<ol style="list-style-type: none">1. CHARGE battery.2. Make sure your product is properly PLUGGED-IN.
Can't transfer a call.	<ol style="list-style-type: none">1. Handset is busy.2. Handset is out of range.3. Wrong handset number.	<ol style="list-style-type: none">1. Check ALL handsets and END all calls.2. Move handset CLOSER to base unit.3. Check HANDSET NUMBER.

Problem	Possible cause(s)	Solution(s)
Bad audio quality (crackles,echo, etc.).	<ol style="list-style-type: none"> 1. Interference from nearby electrical appliance. 2. Base unit is installed in a room with thick walls. 3. The handset is too far from the base unit. 4. If you have Broadband/ADSL you need a in line filter (not supplied). 	<ol style="list-style-type: none"> 1. Try a different connection point, one that is away from other electrical appliances. 2. Install the base unit in a DIFFERENT room OR use EXTENSION leads. 3. Move CLOSER to the base unit. 4. Ensure a in-line ADSL filter is installed on all phone sockets between wall plate and your phone.
Caller ID does not work.	Service not activated.	Check your SUBSCRIPTION with the SERVICE provider.
Phone does not ring when a call comes in.	<ol style="list-style-type: none"> 1. The ringer is off. 2. Too many phones are sharing the same phone line. 3. Base unit not plugged in. 	<ol style="list-style-type: none"> 1. Turn ON the ringer. 2. Disconnect some of the phones from the phone line. 3. Check base unit CONNECTIONS.
Keypad does not work.	Keypad may be locked.	UNLOCK the keypad.
Busy tone + in use light on.	<ol style="list-style-type: none"> 1. Other handset may still be connected. 2. Check power supply connection. 	<ol style="list-style-type: none"> 1. Check ALL handsets and END all calls. 2. Check CONNECTIONS to wall and base.
Handset registration fails continuously.	The base memory may be full.	Delete un-used handset and try again.
Cannot make/answer a 2nd call	2nd call service can be activated.	Check with your service provider. Check the recall selection is correct.

28 APPENDIX

Problem	Possible cause(s)	Solution(s)
eco700 Answering System (ONLY)		
Answering machine does not record messages.	<ol style="list-style-type: none">1. The answer machine may be turned off.2. The memory may be full.3. Answer mode may be set to ANSWER ONLY.	<ol style="list-style-type: none">1. Switch the answering machine on.2. Delete some messages.3. Change the mode to ANSWER & REC.
Cannot access messages remotely.	<ol style="list-style-type: none">1. Remote access may be switched off.2. Wrong PIN is entered.	<ol style="list-style-type: none">1. Switch Remote access on.2. Enter the PIN once again.
Cannot record outgoing message.	<ol style="list-style-type: none">1. The memory may be full.	<ol style="list-style-type: none">1. Delete messages.
Answering machine stops recording part way through a message.	<ol style="list-style-type: none">1. The memory may be full.2. The maximum message length is more than 2 minutes.	<ol style="list-style-type: none">1. Delete messages.

Note:

If none of the above solutions help, reset your phone by disconnecting the mains power from the base and removing batteries from handset/s. Reconnect after 15 minutes.

Alternatively please contact Customer Service on (02) 4574 8888.

Product Specifications

Phone – Oricom eco70/700	Specifications
Frequency range	1.88-1.897 GHz (bandwidth=20MHz)
Channel bandwidth	1.728 MH
Operating range	Up to 300m outdoors, up to 50m indoors
Standby time	Up to 100 hours
Talk time	Up to 10 hours
Temperature time	Operating 0°C to 40°C
	Storage -20°C to 60°C
Compatibility	Only GAP compatible DECT phones
Multiple handset capability	Up to 5 handsets per base
Multiple bases	Up to 4 bases per handset
Ringer melodies	5 polytones + 4 monotones only
Included Accessories	
Battery charge time	14 hours
Rechargeable batteries	AAA Ni-MH 1.2V 500mAh
Mains power supply for base unit and charger	eco70 Input: 100-240VAC 50/60Hz 200mA Output: 6VDC 300mA eco700 Input: 100-240VAC 50/60Hz 200mA Output: 6VDC 500mA ECO70&700 charger (ECO7050): Input: 100~240VAC 200mA; Output: 7.5VDC 100mA;

Warranty Information (Australia)

Oricom makes no other warranties or conditions, express or implied, including as to merchantability and fitness for a particular purpose, except as stated in this Warranty. Any implied warranties that may be imposed by law are limited in duration to the Warranty Period.

Oricom warrants that the product is free from defects in materials or workmanship during the Warranty Period. This Warranty in no way affects your statutory warranty rights under the Trade Practices Act 1974 or any other similar legislation. This Warranty does not extend to any product from which the serial number has been removed, was purchased outside of Australia or that has been damaged or rendered defective:

1. as a result of lightning, over voltage, accident, misuse, abuse or other external causes;
2. the operation outside the normal use of the product;
3. by the use of parts not manufactured or sold by Oricom; or
4. by modification or service by anyone other than:
 - (a) Oricom; or
 - (b) an Oricom authorised service provider.

The Warranty Period will be 12 months from the date of purchase of the product evidenced by your dated sales receipt. You are required to provide proof of purchase as a condition of receiving warranty services. You are entitled

to a replacement or repair according to the terms and conditions of this document if your product is found to be faulty within the Warranty Period. This Warranty extends to the original purchaser only and is not transferable.

Oricom products are manufactured using new materials or new and used materials equivalent to new in performance and reliability. Spare parts may be new or equivalent to new. Spare parts are warranted to be free from defects in material or workmanship for thirty (30) days or for the remainder of the Warranty Period of the Oricom branded product in which they are installed, whichever is longer.

During the Warranty Period, Oricom will replace and where possible repair the defective product. All component parts removed under this Warranty become the property of Oricom.

In the unlikely event that your Oricom product has a recurring failure, Oricom, at its discretion, may elect to provide you with a replacement product of its choosing that is at least equivalent to your product in performance.

Oricom does not warrant that the operation of the product will be uninterrupted or error free. Oricom is not responsible for damage that occurs as a result of your failure to follow the instructions that came with the product.

These terms and conditions together with any specific terms and conditions contained in the user guide to the product purchased constitute the complete and exclusive agreement between you and Oricom regarding the product.

No change to the conditions of this Warranty is valid unless it is made in writing and signed by an authorised representative of Oricom.

Oricom is not liable for any damages caused by the product or the failure of the product to perform, including any lost profits or savings or special, incidental or consequential damages. Oricom is not liable for any claim made by a third party or made by you on behalf of a third party.

This limitation of liability applies whether damages are sought, or a claim made, under this Warranty or as a tort claim (including negligence and strict product liability), a contract claim or any other claim. However, this limitation of liability will not apply to claims for personal injury.

Nothing in this Warranty excludes, restricts or modifies any condition, warranty, right or remedy which pursuant to the Trade Practices Act 1974 applies to this Warranty and which may not be so excluded, restricted or modified. For warranties that cannot be excluded, restricted or modified, Oricom limits the remedies available to those specified in the relevant legislation.

Notes for operation in New Zealand

The grant of a Telepermit for any item of terminal equipment indicates only that Telecom has accepted that the item complies with the minimum conditions for connection to its network. It indicates no endorsement of the product by Telecom, nor does it provide any sort of warranty. Above all, it provides no assurance that any item will work correctly in all respects with another item of Telepermitted equipment of a different make or model, nor does it imply that any product is compatible with all of Telecom's network services. This device may be subject to ringing or bell tinkle when certain other devices are connected to the same line. If this occurs, the problem should not be referred to the Telecom Faults service.

This equipment shall not be set to make automatic calls to the Telecom "111" Emergency Service.

This equipment may not provide for the effective hand-over of a call to another device connected to the same line.

32 APPENDIX

REN (RN for New Zealand)

The REN (Ringer Equivalence Number) or (RN) is of significance only if you wish to connect more than 1 telephone to your telephone line. A standard telephone line has a maximum REN capacity of 3 (RN of 5). It is possible to connect 3 (5) devices with a REN of 1 (RN of 1) with no degradation to the product's performance. Exceeding this limit may cause the volume of the ringer in any phone to decrease or not ring at all.

Caller ID

Customers using non Telecom toll services should not use the dial back feature for local calls as this will incur a charge only the 7 digit number should be dialled. Some of the CID services listed may not be available in New Zealand.

This telephone is not designed for making emergency telephone calls when the power fails. Make alternative arrangements for access to emergency services.

Australia

Oricom International Pty Ltd

Locked Bag 658

South Windsor, NSW 2756

Customer Support

Email: support@oricom.com.au

Web: www.oricom.com.au

Phone: (02) 4574 8888

Fax: (02) 4574 8898

