

# Makita

## Cordless Drill

**10 mm (3/8'')** MODEL 6010SD  
**10 mm (3/8'')** MODEL 6010SDW  
With Quick Charger

### INSTRUCTION MANUAL

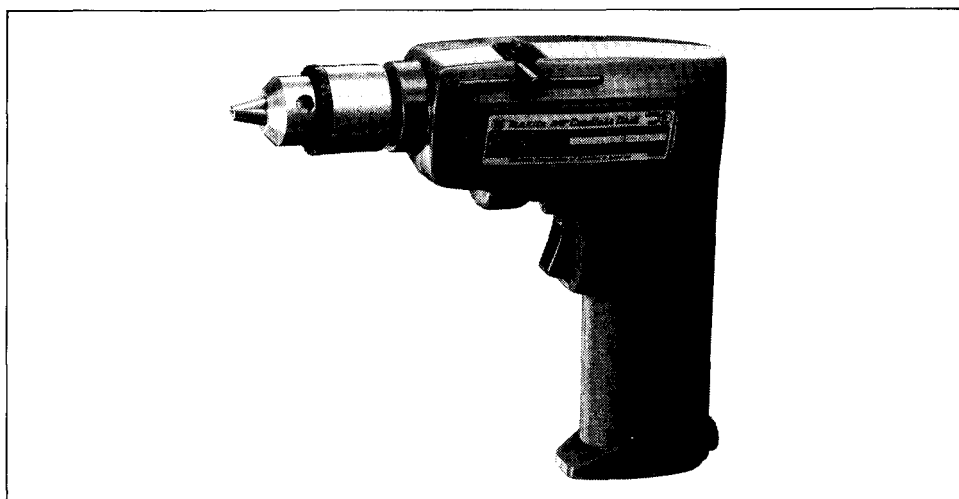

#### SPECIFICATIONS

• Model 6010SD

Capacities		No load speed	Dimensions (L x W x H)	Net weight
Steel/Wood	Wood screw			
10 mm (3/8'')	4.5 mm x 20 mm (3/16'' x 3/4'')	600 R/min.	205 mm x 48 mm x 175 mm (8'' x 1-7/8'' x 6-7/8'')	0.95 kg (2.1 lbs)

• Model DC7020 Quick Charger

Input	Output	Charging time
A.C. only 50 Hz - 60 Hz	DC 7.2 V.	3 Hr.

- \* Manufacturer reserves the right to change specifications without notice.
- Note: Specifications may differ from country to country.

# **IMPORTANT SAFETY INSTRUCTIONS**

**(For All Tools)**

**WARNING: WHEN USING ELECTRIC TOOLS, BASIC SAFETY PRECAUTIONS SHOULD ALWAYS BE FOLLOWED TO REDUCE THE RISK OF FIRE, ELECTRIC SHOCK, AND PERSONAL INJURY, INCLUDING THE FOLLOWING:**

## **READ ALL INSTRUCTIONS.**

- 1. KEEP WORK AREA CLEAN.** Cluttered areas and benches invite injuries.
- 2. CONSIDER WORK AREA ENVIRONMENT.** Don't use power tools in damp or wet locations. Keep work area well lit. Don't expose power tools to rain. Don't use tool in presence of flammable liquids or gases.
- 3. KEEP CHILDREN AWAY.** All visitors should be kept away from work area. Don't let visitors contact tool or extension cord.
- 4. STORE IDLE TOOLS.** When not in use, tools should be stored in dry, and high or locked-up place — out of reach of children.
- 5. DON'T FORCE TOOL.** It will do the job better and safer at the rate for which it was intended.
- 6. USE RIGHT TOOL.** Don't force small tool or attachment to do the job of a heavy-duty tool. Don't use tool for purpose not intended.
- 7. DRESS PROPERLY.** Don't wear loose clothing or jewelry. They can be caught in moving parts. Rubber gloves and non-skid footwear are recommended when working outdoors. Wear protective hair covering to contain long hair.
- 8. USE SAFETY GLASSES.** Also use face or dust mask if cutting operation is dusty.
- 9. DON'T ABUSE CORD.** Never carry tool by cord or yank it to disconnect from receptacle. Keep cord from heat, oil, and sharp edges.
- 10. SECURE WORK.** Use clamps or a vise to hold work. It's safer than using your hand and it frees both hands to operate tool.
- 11. DON'T OVERREACH.** Keep proper footing and balance at all times.
- 12. MAINTAIN TOOLS WITH CARE.** Keep tools sharp and clean for better and safer performance. Follow instructions for lubricating and changing accessories. Inspect tool cords periodically and if damaged, have repaired by authorized service facility. Inspect extension cords periodically and replace if damaged. Keep handles dry, clean, and free from oil and grease.
- 13. DISCONNECT TOOLS.** When not in use, before servicing, and when changing accessories, such as blades, bits, cutters.

14. **REMOVE ADJUSTING KEYS AND WRENCHES.** Form habit of checking to see that keys and adjusting wrenches are removed from tool before turning it on.
15. **AVOID UNINTENTIONAL STARTING.** Don't carry plugged-in tool with finger on switch. Be sure switch is OFF when plugging in.
16. **OUTDOOR USE EXTENSION CORDS.** When tool is used outdoors, use only extension cords intended for use outdoors and so marked.
17. **STAY ALERT.** Watch what you are doing, use common sense. Don't operate tool when you are tired.
18. **CHECK DAMAGED PARTS.** Before further use of the tool, a guard or other part that is damaged should be carefully checked to determine that it will operate properly and perform its intended function. Check for alignment of moving parts, binding of moving parts, breakage of parts, mounting, and any other conditions that may affect its operation. A guard or other part that is damaged should be properly repaired or replaced by an authorized service center unless otherwise indicated elsewhere in this instruction manual. Have defective switches replaced by authorized service center. Don't use tool if switch does not turn it on and off.
19. **GUARD AGAINST ELECTRIC SHOCK.** Prevent body contact with grounded surfaces. For example; pipes, radiators, ranges, refrigerator enclosures.
20. **REPLACEMENT PARTS.** When servicing, use only identical replacement parts.

**VOLTAGE WARNING:** Before connecting the tool to a power source (receptacle, outlet, etc.) be sure the voltage supplied is the same as that specified on the nameplate of the tool. A power source with voltage greater than that specified for the tool can result in **SERIOUS INJURY** to the user — as well as damage to the tool. If in doubt, **DO NOT PLUG IN THE TOOL.** Using a power source with voltage less than the nameplate rating is harmful to the motor.

# IMPORTANT SAFETY INSTRUCTIONS

- 1. SAVE THESE INSTRUCTIONS** — This manual contains important safety and operating instructions for battery charger.
- 2. Before using battery charger, read all instructions and cautionary markings on (1) battery charger, (2) battery, and (3) product using battery.**
- 3. CAUTION — To reduce risk of injury, charge only MAKITA type rechargeable batteries. Other types of batteries may burst causing personal injury and damage.**
- 4. Do not expose charger to rain or snow.**
- 5. Use of an attachment not recommended or sold by the battery charger manufacturer may result in a risk of fire, electric shock, or injury to persons.**
- 6. To reduce risk of damage to electric plug and cord, pull by plug rather than cord when disconnecting charger.**
- 7. Make sure cord is located so that it will not be stepped on, tripped over, or otherwise subjected to damage or stress.**
- 8. Do not operate charger with damaged cord or plug — replace them immediately.**
- 9. Do not operate charger if it has received a sharp blow, been dropped, or otherwise damaged in any way; take it to a qualified serviceman.**
- 10. Do not disassemble charger or battery cartridge; take it to a qualified serviceman when service or repair is required. Incorrect reassembly may result in a risk of electric shock or fire.**
- 11. To reduce risk of electric shock, unplug charger from outlet before attempting any maintenance or cleaning. Turning off controls will not reduce this risk.**

## **ADDITIONAL SAFETY RULES FOR CHARGER AND TOOL**

- 1. The Charger and the tool are specifically designed to work together. Do not attempt to charge any other cordless tool with this Charger. Do not attempt to charge the tool with any other charger.**
- 2. Do not charge the tool when temperature is BELOW 10°C (50°F) or ABOVE 45°C (113°F).**
- 3. Do not use charger in damp or wet locations.**
- 4. Do not attempt to use a step-up transformer, an engine generator or DC power receptacle.**
- 5. Do not store the tool in locations where the temperature may reach or exceed 50°C (122°F).**
- 6. Do not incinerate the tool even if it is severely damaged or is completely worn out. The tool can explode in a fire.**

## **ADDITIONAL SAFETY RULES FOR CORDLESS DRILL**

- 1. Be aware that this tool is always in an operating condition, because it does not have to be plugged into an electrical outlet.**
- 2. Always be sure you have a firm footing  
Be sure no one is below when using the tool in high locations.**
- 3. Hold the tool firmly.**
- 4. Keep hands away from rotating parts.**
- 5. When drilling into walls, floors or wherever "live" electrical wires may be encountered, DO NOT TOUCH ANY METAL PARTS OF THE TOOL!  
Hold the tool only by the plastic handle or plastic tool body to prevent electric shock if you drill into a "live" wire.**
- 6. Do not leave the tool running. Operate the tool only when hand-held.**
- 7. Do not touch the drill bit or the workpiece immediately after operation, they may be extremely hot and could burn your skin.**

**SAVE THESE INSTRUCTIONS.**

## HOW TO USE

### Charging

Connect the charging plug to the charging connector, then plug in the charger to the power receptacle. Charging takes 3 hours.

#### CAUTION:

- The battery in your new tool is not fully charged. You will need to charge it before use.
- Do not operate the tool during charging.
- Overcharging more than 2 days considerably shortens the battery service life. Always unplug the charger after completing the charge.
- When you charge a new tool or a tool which has not been used for a long period, it may not accept a full charge. This is a normal condition and does not indicate a problem. You can recharge the tool fully after discharging it almost completely a couple of times.

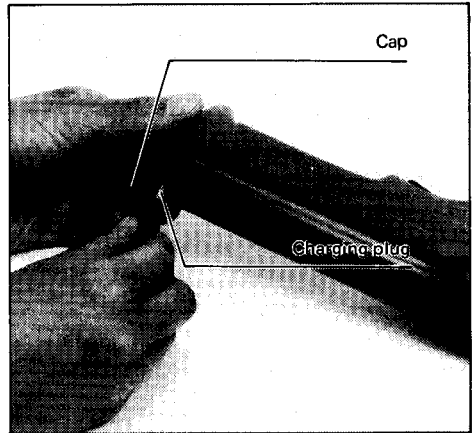

### Installing and removing bit

To install the drill bit, place it in the chuck as far as it will go. Tighten the chuck collar by hand. Place the chuck key in each of three holes, and tighten clockwise.

To remove the drill bit, place the chuck key into the chuck hole and turn counter-clockwise.

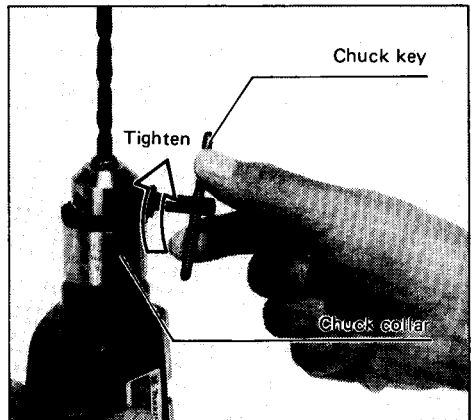

#### CAUTION:

Always set the Forward-Reverse switch lever to NEUTRAL when installing, removing or adjusting bits of accessories.

After use, return the chuck key to the storage cavity on the tool.

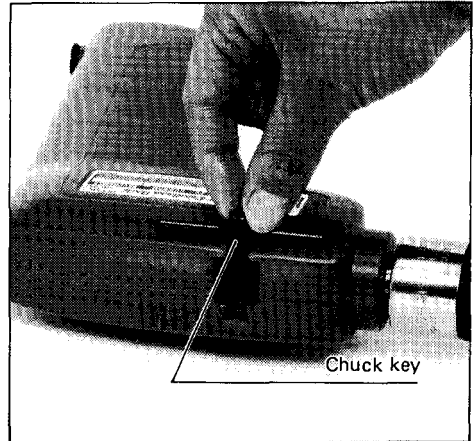

**Switch action**

Set the reversing switch lever just in front of the trigger switch to Forward (FWD) or Reverse (REV). Then pull the trigger to turn the tool ON and release it to turn it OFF. To change the direction of bit rotation, release the trigger, let the tool come to a complete stop, and then slide the reversing switch lever to the opposite side. When the reversing switch lever is in the neutral position, the tool will not start even if you pull the trigger.

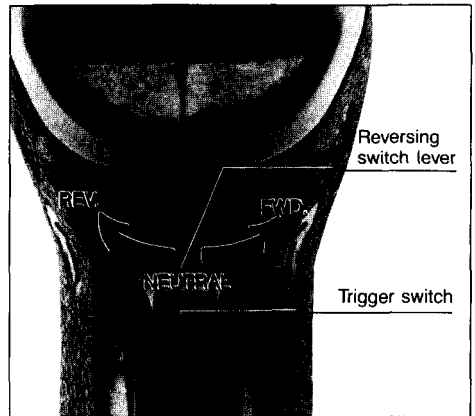

**CAUTIONS:**

- When not operating the tool, keep the reversing switch lever in the neutral position.
- Before operation, always check to be sure that the reversing switch lever is set for the desired direction of rotation.

### **Holding tool**

Hold the tool as shown in the figure. When drilling a large diameter hole, hold the tool firmly with both hands.

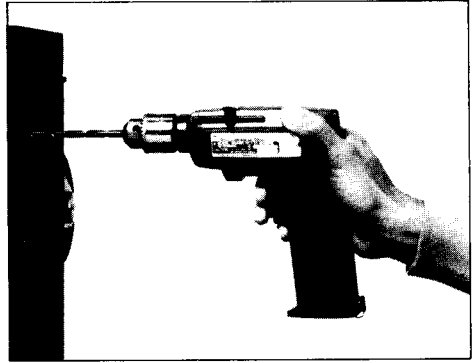

### **Drilling in metal**

Punch a small hole in the metal to prevent the bit from skittering when starting to drill a hole.

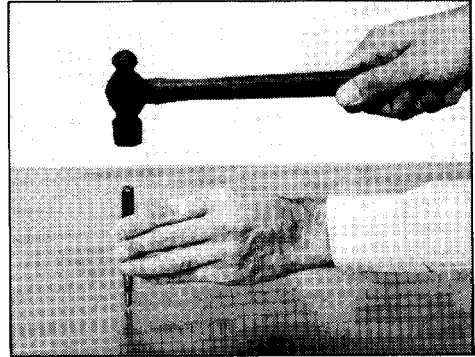

Use cutting lubricant on the bit to facilitate drilling if necessary.

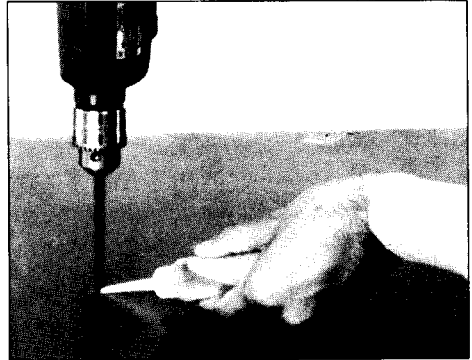

Pressing down too hard on the tool will not speed up the drilling. In fact, this undue pressure will only serve to damage the tip of your drill bit, decrease your drilling performance and shorten the service life of the tool.

There is a tremendous force exerted on the tool/bit at the time of hole break through. Grip the drill firmly and exert care when the bit begins to break through the material.



## Screwdriving

Match your bit to your screw.

### 1. Phillips bits

Select your screws and nominal diameter with the chart on the right.

Item	Nominal Diameter (mm)
Bit No.	Wood Screw
No. 1	2.1 – 2.7 (3/32" – 1/8")
No. 2	3.1 – 4.5 (1/8" – 3/16")

### 2. Slotted bits

Select a slotted bit to match the slot on the screw heads. If the bit is too small for the screw slot, the bit and/or screw head may be damaged.

## Overload protector

The overload protector automatically cuts out to break the circuit whenever heavy work is prolonged. Wait 20–30 seconds before resuming operation.

## Hole

The hole on the heel of the tool is a convenient way to carry it by a cord, hook or other means.

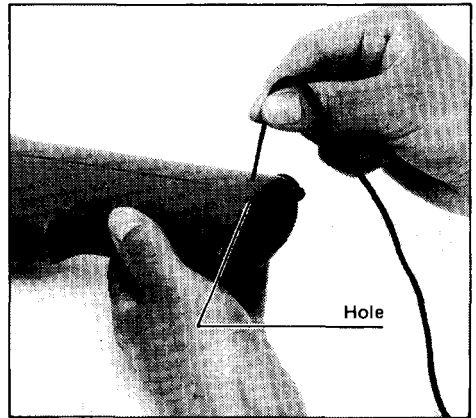

## MAINTENANCE

### CAUTION:

Always be sure that the tool is switched off before attempting to perform inspection or maintenance.

To maintain product **SAFETY** and **RELIABILITY**, repairs, maintenance and adjustment should be performed by Makita Authorized or Factory Service Centers, always using Makita replacement parts.

## ACCESSORIES

### CAUTION:

These accessories or attachments are recommended for use with your Makita tool specified in this manual. The use of any other accessories or attachments might present a risk of injury to persons. The accessories or attachments should be used only in the proper and intended manner.

#### ● Rubber pad assembly

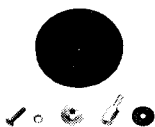

#### ● Wool bonnet



#### ● Wax buffer





#### ● Tool holster

has some bits storage space

Use holster to carry drill only after removing bit. Also, keep the reversing switch lever in neutral position when carrying in the holster.



#### ● Bits

	Size
Phillips 	#2
Slotted 	#5F
Square drill bit 	

#### ● Quick charger

(A.C. only)



#### ● 12-volt Quick charger



#### ● Chuck key S10

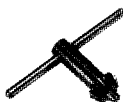

#### ● Keyless drill chuck



# 10 mm (3/8'')

## CORDLESS DRILL

### Model 6010SD

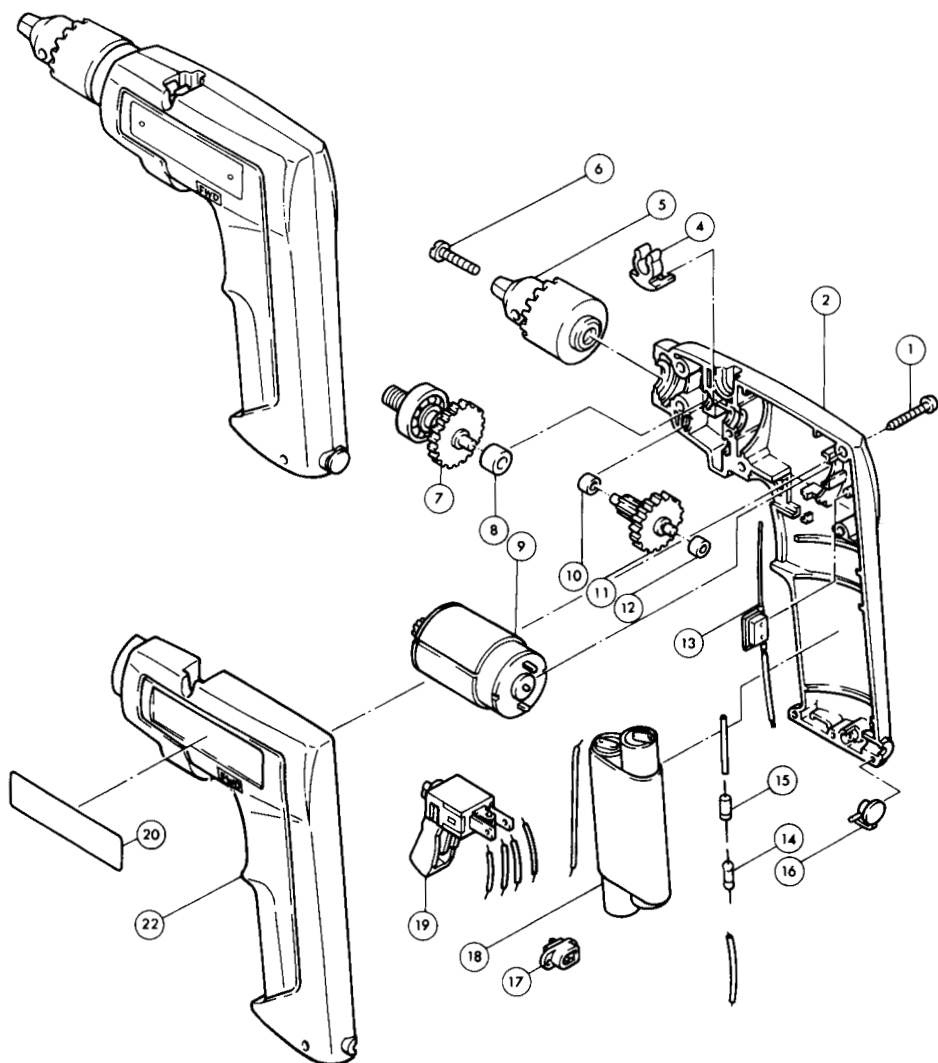

Note: The switch and other part configurations may differ from country to country.

MODEL 6010SD

ITEM NO.	NO. USED	DESCRIPTION	ITEM NO.	NO. USED	DESCRIPTION
<b>MACHINE</b>			<b>MACHINE</b>		
1	6	Screw 3x20	13	1	Current Relay
2	1	Housing Set (With Item 22)	14	1	Resistance
4	1	Holder 6	15	1	Diode
5	1	Drill Chuck S10	16	1	Cap
6	1	Screw M5x18	17	1	Inlet
7	1	Gear	18	1	Battery
8	1	Plane Bearing 5	19	1	Switch
9	1	Motor	20	1	Name Plate
10	1	Plane Bearing 3			
11	1	Gear 13-58	22	1	Housing Set (With Item 2)
12	1	Plane Bearing 3			

Note: The switch and other part specifications may differ from country to country.

# **MAKITA LIMITED ONE YEAR WARRANTY**

## **Warranty Policy**

Every Makita tool is thoroughly inspected and tested before leaving the factory. It is warranted to be free of defects from workmanship and materials for the period of ONE YEAR from the date of original purchase. Should any trouble develop during this one-year period, return the COMPLETE tool, freight prepaid, to one of Makita's Factory or Authorized Service Centers. If inspection shows the trouble is caused by defective workmanship or material, Makita will repair (or at our option, replace) without charge.

This Warranty does not apply where:

- repairs have been made or attempted by others;
- repairs are required because of normal wear and tear;
- The tool has been abused, misused or improperly maintained;
- alterations have been made to the tool.

**IN NO EVENT SHALL MAKITA BE LIABLE FOR ANY INDIRECT, INCIDENTAL OR CONSEQUENTIAL DAMAGES FROM THE SALE OR USE OF THE PRODUCT. THIS DISCLAIMER APPLIES BOTH DURING AND AFTER THE TERM OF THIS WARRANTY.**

**MAKITA DISCLAIMS LIABILITY FOR ANY IMPLIED WARRANTIES, INCLUDING IMPLIED WARRANTIES OF "MERCHANTABILITY" AND "FITNESS FOR A SPECIFIC PURPOSE," AFTER THE ONE-YEAR TERM OF THIS WARRANTY.**

This Warranty gives you specific legal rights, and you may also have other rights which vary from state to state. Some states do not allow the exclusion or limitation of incidental or consequential damages, so the above limitation or exclusion may not apply to you. Some states do not allow limitation on how long an implied warranty lasts, so the above limitation may not apply to you.

**Makita Corporation of America**

Buford, GA

883410D991

PRINTED IN USA  
1991-8-C