

Model 27831 Series 2.4 GHz Cordless Telephone System User's Guide



- If your home has specially wired alarm equipment connected to the telephone line, ensure the installation of this product does not disable your alarm equipment. If you have questions about what will disable alarm equipment, consult your telephone company or a qualified installer.

US Number is located on the cabinet bottom.
REN Number is located on the cabinet bottom.

2 Rights of the Telephone Company

Should your equipment cause trouble on your line which may harm the telephone network, the telephone company shall, where practicable, notify you that temporary discontinuance of service may be required. Where prior notice is not practicable and the circumstances warrant such action, the telephone company may temporarily discontinue service immediately. In case of such temporary discontinuance, the telephone company must: (1) promptly notify you of such temporary discontinuance; (2) afford you the opportunity to correct the situation; and (3) inform you of your right to bring a complaint to the Commission pursuant to procedures set forth in Subpart E of Part 68, FCC Rules and Regulations.

The telephone company may make changes in its communications facilities, equipment, operations or procedures where such action is required in the operation of its business and not inconsistent with FCC Rules and Regulations. If these changes are expected to affect the use or performance of your telephone equipment, the telephone company must give you adequate notice, in writing, to allow you to maintain uninterrupted service.

Interference Information

This device complies with Part 15 of the FCC Rules. Operation is subject to the following two conditions: (1) This device may not cause harmful interference; and (2) This device must accept any interference received, including interference that may cause undesired operation.

This equipment has been tested and found to comply with the limits for a Class B digital device, pursuant to Part 15 of the FCC Rules. These limits are designed to provide reasonable protection against harmful interference in a residential installation.

This equipment generates, uses, and can radiate radio frequency energy and, if not installed and used in accordance with the instructions, may cause harmful interference to radio communications. However, there is no guarantee that interference will not occur in a particular installation.

Privacy of Communications may not be ensured when using this product.

If this equipment does cause harmful interference to radio or television reception, which can be determined by turning the equipment off and on, the user is encouraged to try to correct the interference by one or more of the following measures:

- Reorient or relocate the receiving antenna that is, the antenna for radio or television that is "receiving" the interference.
- Reorient or relocate and increase the separation between the telecommunications equipment and receiving antenna.
- Connect the telecommunications equipment into an outlet on a circuit different from that to which the receiving antenna is connected.

If these measures do not eliminate the interference, please consult your dealer or an experienced radio/television technician for additional suggestions. Also, the Federal Communications Commission has prepared a helpful booklet, "How To Identify and Resolve Radio/TV Interference Problems." This booklet is available from the U.S. Government Printing Office, Washington, D.C. 20402. Please specify stock number 004-000-00345-4 when ordering copies.

Notice: The changes or modifications not expressly approved by the party responsible for compliance could void the user's authority to operate the equipment.

Hearing Aid Compatibility (HAC)

This telephone system meets FCC standards for Hearing Aid Compatibility.

Licensing

Licensed under US Patent 6,427,009.

FCC RF Radiation Exposure Statement

This equipment complies with FCC RF radiation exposure limits set forth for an uncontrolled environment. This equipment should be installed and operated with a minimum distance of 20 centimeters between the radiator and your body. This transmitter must not be co-located or operated in conjunction with any other antenna or transmitter."

Notes

- This equipment may not be used on coin service provided by the telephone company.
- Party lines are subject to state tariffs, and therefore, you may not be able to use your own telephone equipment if you are on a party line. Check with your local telephone company.
- Notice must be given to the telephone company upon permanent disconnection of your telephone from your line.

Visit the GE website at: www.GE.com/phones

Model 27831D
00008249 (Rev. 4 Dom E)
08-03
Printed in China



Thomson Inc.
101 West 103rd Street
Indianapolis, IN 46290-1102
© 2008 Thomson, Inc.
Trademarks(s) © Registered
Marca(s) Registrados(s)

WARNING: TO PREVENT FIRE OR ELECTRICAL SHOCK HAZARD, DO NOT EXPOSE THIS PRODUCT TO RAIN OR MOISTURE.

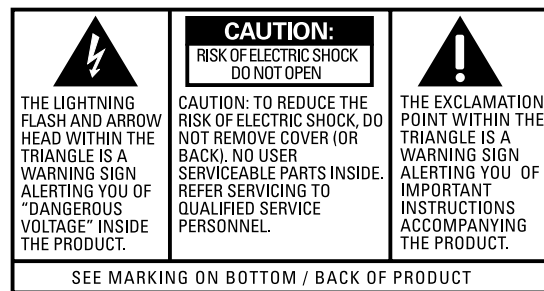

Introduction

CAUTION: When using telephone equipment, there are basic safety instructions that should always be followed. Refer to the IMPORTANT SAFETY INSTRUCTIONS provided with this product and save them for future reference.

IMPORTANT: Because cordless phones operate on electricity, you should have at least one phone in your home that isn't cordless, in case the power in your home goes out.

Before You Begin

Parts Checklist (for 27831xx1 model)

Make sure your package includes the items shown here.

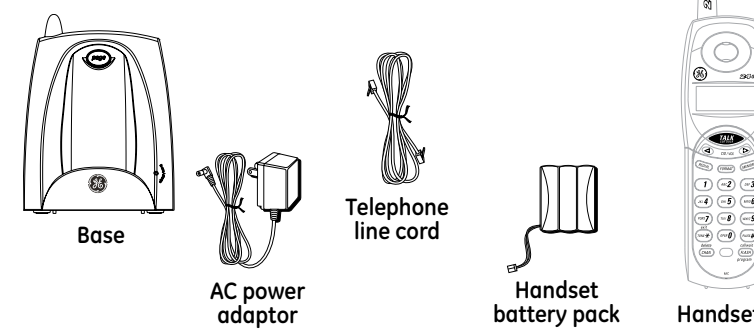

For Model 27831xx2 there will be **ONE** additional handset, charge cradle, battery pack and cover than shown above.

IMPORTANT: You can only use one handset at a time and there is NO conference and intercom features for these units.

Telephone Jack Requirements

To use this phone, you need an RJ11C type modular telephone jack, which might look like the one pictured here, installed in your home. If you don't have a modular jack, call your local phone company to find out how to get one installed

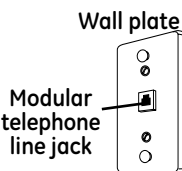

Installation

Digital Security System

Your cordless phone uses a digital security system to protect against false ringing, unauthorized access, and charges to your phone line.

INSTALLATION NOTE: Some cordless telephones operate at frequencies that may cause or receive interference with nearby TVs, microwave ovens, and VCRs. To minimize or prevent such interference, the base of the cordless telephone should not be placed near or on top of a TV, microwave ovens, or VCR. If such interference continues, move the cordless telephone farther away from these appliances.

Certain other communications devices may also use the 2.4 GHz frequency for communication, and, if not properly set, these devices may interfere with each other and/or your new telephone. If you are concerned with interference, please refer to the owner's manual for these devices on how to properly set channels to avoid interference. Typical devices that may use the 2.4 GHz frequency for communication include wireless audio/video senders, wireless computer networks, multi-handset cordless telephone systems, and some long-range cordless telephone systems.

Important Installation Guidelines

- Avoid sources of noise and heat, such as motors, fluorescent lighting, microwave ovens, heating appliances and direct sunlight.
- Avoid areas of excessive dust, moisture and low temperature.
- Avoid other cordless telephones or personal computers.
- Never install telephone wiring during a lightning storm.
- Never install telephone jacks in wet locations unless the jack is specifically designed for wet locations.
- Never touch non-insulated telephone wires or terminals, unless the telephone line has been disconnected at the network interface.
- Use caution when installing or modifying telephone lines.

Handset Layout

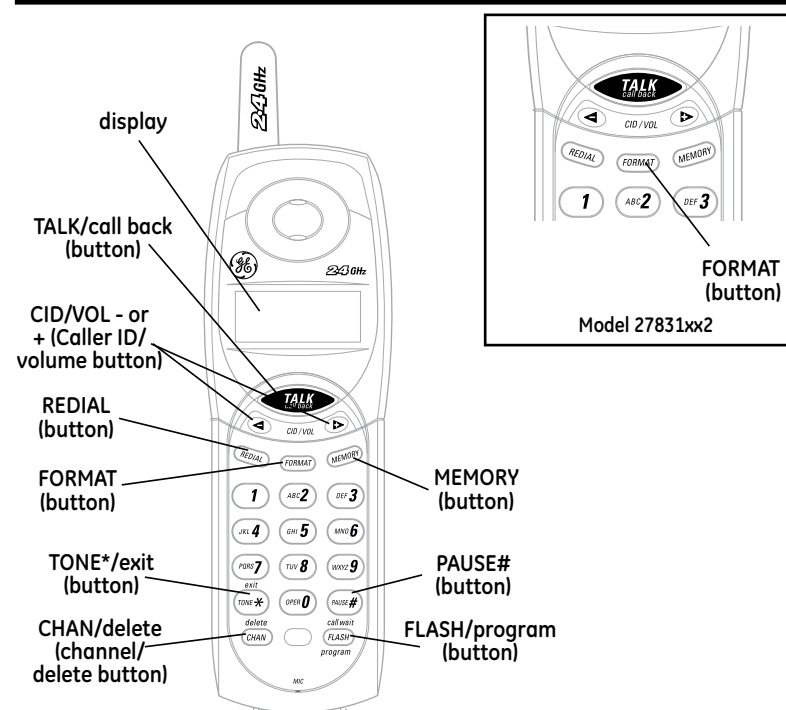

Installing the Phone

Installing the Handset Battery

NOTE: You must connect the handset battery before use.

CAUTION: To reduce the risk of fire or personal injury, use only the Thomson Inc. approved Nickel-Cadmium (Ni-Cd) battery model 5-2459 or Nickel-metal Hydride (Ni-MH) model 5-2522, which is compatible with this unit.

- Locate battery and battery door which are packaged together inside a plastic bag and are separate from the handset.
- Locate the battery compartment on the back of the handset.
- Plug the battery pack cord into the jack inside the compartment.

NOTE: To ensure proper battery installation, the connector is keyed and can be inserted only one way.

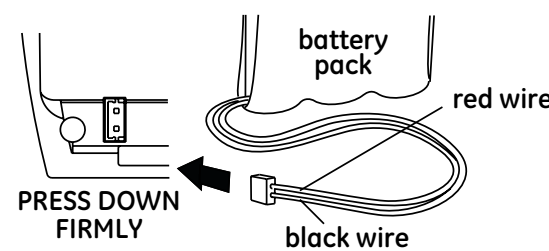

- Insert the battery pack.
- Close the battery compartment by pushing the door up until it snaps into place.

Base Station

- Choose an area near an electrical outlet and a telephone wall jack (RJ11C), and place your cordless telephone on a level surface, such as a desktop or tabletop, or you may mount it on the wall.

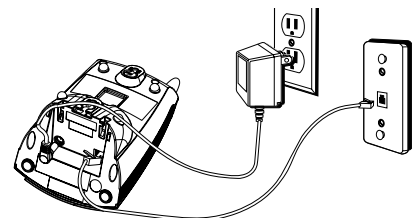

- Plug one end of the telephone line cord into the TEL LINE jack on the bottom of the base and the other end into a modular jack.

- Plug the AC power converter into the electrical outlet and the DC connector into the jack on the bottom of the base.

- Set the ringer switch (on the handset) to ON, and place the handset in the cradle on the base.

- The in use/charge indicator turns on, verifying the battery is charging. The unit will take 20 seconds to register and verify its security code.

NOTE: In case of a power failure, the handset may display UNAVAILABLE when the TALK/CALL BACK button is pressed. You must then place all handsets on the main base cradle for 20 seconds to re-register.

- Allow the phone to charge for 16 hours prior to first use. If you don't properly charge the phone, battery performance is compromised.

CAUTION: To reduce risk of personal injury, fire, or damage use only the 5-2616 or 5-2749 (black), or 5-2617 or 5-2748 (gray) power adaptor listed in the user's guide. This power adaptor is intended to be correctly orientated in a vertical or floor mount position.

Extra Charge Cradle (applicable only with Model 27831xx2)

- Plug the extra charging cradle into the electrical outlet.
- Place the handset on the charging cradle.
- The charge indicator turns on, verifying the battery is charging.
- Allow the phone to charge for 16 hours prior to first use.

VERY IMPORTANT: BOTH HANDSETS MUST BE REGISTERED TO THE MAIN BASE BEFORE USE. After the 2nd handset has charged for 16 hours, place it on the main base station for 20 seconds, it will then automatically register and verify its security code.

Wall Mounting

If you want to mount the phone on a wall, slip the mounting holes (on the back of the base) over the wall plate posts, and slide the unit down into place. (Wall plate not included.)

Handset Setup

There are six programmable menus available: Language, Local Area Code, Ringer ON/OFF, Ringer Tone, Tone/Pulse and Factory Default. When you program these settings, make sure the phone is OFF (not in talk mode). Pressing the TONE*/exit button will remove you from the menu selection process without changing the feature you are in.

Display Language

- Press the FLASH/program button until the screen displays **1ENG 2FRA 3ESP**.
- Use the CID/VOL (left or right arrow) button or the handset number pad to select 1 (English), 2 (French), or 3 (Spanish). The default setting is "1ENG".
- Press the FLASH/program button to confirm and to advance to the next menu feature.

Local Area Code

If you enter your local 3-digit area code in the area code menu, your local area code does not display on the Caller ID (CID) list. Instead, you only see the local 7-digit number. Calls received from outside your local area code will display the full 10-digit number.

- Press the FLASH/program button until the screen displays **AREA CODE - - -**. The default setting is "- - -".
- Use the handset number pad to enter your 3-digit area code.

NOTE: If you make a mistake, press the CHAN/delete button to erase the incorrect area code and repeat step 2.

- Press the FLASH/program button to confirm and to advance to the next menu feature.

Set Ringer ON/OFF

- Press the FLASH/program button until the screen displays **RINGER 1ON 2OFF**.
- Use the CID/VOL (left or right arrow) button or the handset number pad (1-2) to enter your selection from **1ON** or **2OFF**. The default setting is "1ON".
- Press the FLASH/program button to confirm and to advance to the next menu feature.

Ringer Tone

- Press the FLASH/program button until the screen displays **RINGER TONE**.
- Use the CID/VOL (left or right arrow) button or the handset number pad (1-3) to enter your selection from Ringer Tone 1, 2, or 3. The default setting is "RINGER TONE 1".

- Press the FLASH/program button to confirm and to advance to the next menu feature.

Tone/Pulse

- Press the FLASH/program button until the screen displays **1 TONE 2 PULSE**.
- Use the CID/VOL (left or right arrow) button or the handset number pad to enter your selection. The default setting is "1 TONE".
- Press the FLASH/program button to confirm and to advance to the next menu feature.

NOTE: For Model 27831xx2, this setting should be changed on both handsets.

Factory Default

This feature allows you to restore the unit's original features.

- Press the FLASH/program button until the screen displays **DEFAULT**.
- Use the CID/VOL (left or right arrow) button to scroll to YES. The default setting is "NO".
- Press FLASH/program to confirm. You will hear a confirmation tone.

Cordless Phone Basics

Making a Call

- Press the TALK/call back button and dial the desired number.

-OR-

- To perform preview dial, dial the number first then press the TALK/call back button.
- To hang up, press the TALK/call back button or place the handset in the cradle.

Receiving a Call

- To answer a call press the TALK/call back button on the handset before you begin speaking.
- To hang up, press the TALK/call back button or place the handset in the cradle.

Call Transfer (applicable only with Model 27831xx2)

During an external call, you may transfer the call to another handset.

- Press the FORMAT button on originating handset. The screen displays **TRANSFERRING**. Both handsets will be paged.
- Press the FORMAT or TALK/call back button on the receiving handset to answer the call.

NOTE: To cancel the call transfer, you may press the TONE*/exit or the FORMAT button on the originating handset.

Redial

Press the REDIAL button to quickly dial the last number you called (up to 32 digits).

If you get a busy signal, and want to keep dialing the number, press redial to dial the number again.

In Use Indicator

When the in use/charge indicator on the base is lit, the handset is either in use or charging. The in use/charge indicator on the base flashes when you receive a call.

Flash

If you subscribe to the combined Call Waiting Caller ID service from your local telephone company you will receive Caller ID information (if available) on Call Waiting calls. During a phone call, you will hear a beep to indicate another call is waiting on the line and Caller ID information for the waiting call shows on the handset display. To connect the waiting call, press the FLASH/program button on the handset and your original call is put on hold. You may switch back and forth between the two calls by pressing the FLASH/program button.

TIP: Do not use the TALK/call back button to activate custom calling services such as call waiting, or you'll hang up the phone.

Volume

When the phone is ON, press the CID/VOL (left or right arrow) on the handset to adjust the volume of the handset's earpiece. There are four settings. Press the right arrow to increase the volume and left arrow to decrease the volume. You will see the volume setting on the handset display. VOL 4 is the maximum and VOL 1 is the minimum.

Channel Button

While talking on the phone, you might need to manually change the channel in order to reduce static caused by appliances, such as baby monitors, garage door openers, microwave ovens, or other cordless phones. Press and release the CHAN/delete button to move to the next clear channel.

Temporary Tone

This feature is useful only if you have pulse (rotary) service. Temporary Tone Dialing enables pulse (rotary) service phone users to access touchtone services offered by banks, credit card companies, etc. For example, when you call your bank you may need to enter your bank account number. Temporarily switching to touchtone mode allows you to send your number.

- Dial the telephone number and wait for the line to connect.
- When your call is answered, press the TONE*/exit button on the handset to temporarily change from pulse dialing to tone dialing.
- Follow the automated instructions to get the information you need.
- Hang up the handset and the phone automatically returns to pulse (rotary) dialing mode.

Exit

Press the TONE*/exit button to cancel any command you initiated.

Paging the Handset

This feature helps to locate a misplaced handset.

Press the page button on the base. The handset will beep for about two minutes or until you press TALK/call back on the handset or press the page button on the base.

NOTE: You can still page the handset if the ringer is turned off. If the battery is dead, the Paging feature will not work.

Caller ID (CID)

IMPORTANT: In order to use this unit's Caller ID features, you must subscribe to either the standard Name/Number Caller ID Service or Call Waiting Caller ID Service. To know who is calling while you are on the phone, you must subscribe to Call Waiting Caller ID Service.

This unit receives and displays information transmitted by your local phone company. This information can include the phone number, date, and time; or the name, phone number, date, and time.

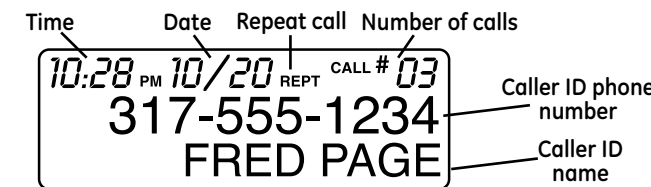

Call Waiting Caller ID

Provided you subscribe to Call Waiting Caller ID service from your phone company; if you receive an incoming call and you are already on the phone, a beep indicates the presence of a Call Waiting call on the line. Only the handset that is in use at the time of the call will display and store the Call Waiting Caller ID information.

- When you hear the call waiting beep in the handset receiver, press the FLASH/program button to put the current call on hold and answer the incoming call. Press FLASH/program again to return to the original call.

Receiving CID Records

When you receive a call, the Caller ID information is transmitted between the first and second ring. The Caller ID information appears on the display while the phone rings, giving you a chance to monitor the information and decide whether or not to answer the call.

Storing CID Records (In CID Memory)

If you are not at home or cannot answer, your telephone's Caller ID memory stores the data for the 40 most recent calls you received so you can see who called while you were unavailable. When the 41st call is received, the oldest Caller ID record (1st call) is automatically deleted.

You may review the stored information at any time. Calls received since your last review show as **NEW** in the display. Calls that have not been previously reviewed but were received from the same number more than once the screen displays the character(s) as **REPT**.

Reviewing CID Records

As calls are received and stored, the display is updated to let you know how many calls have been received. To scroll CID records:

- Make sure the phone is **OFF** (not in TALK mode).
- Press the CID/VOL (-) button to review the newest CID record.
- Press the CID/VOL (+) button to review the oldest CID record first.

Dialing a CID Number

- Make sure the phone is **OFF** (not in TALK mode).
- Use the CID/VOL (- or +) button to display the desired record.
- Press the TALK/call back button. The number dials automatically.

NOTE: Depending on (a) how the incoming caller's phone number is formatted when it is received, and (b) whether or not you previously pre-programmed your local area code into the set up menu, you may need to adjust the format of the incoming caller's stored phone number before making the call, press the FORMAT button to adjust the number, and try again

Available formats include:

Number of digits	Explanation	Example
Eleven digits	long distance code *1 * +3-digit area code +7-digit telephone number.	1-317-888-8888
Ten digits	3-digit area code + 7-digit telephone number.	317-888-8888
Seven digits	7-digit telephone number.	888-8888

Storing CID Records in Internal Memory

You may also store CID information in the phone's internal memory.

NOTE: It is important that you format CID records correctly BEFORE storing in internal memory as you cannot reformat CID records stored in memory.

- Make sure the phone is **OFF** (not in TALK mode).
- Use the CID/VOL (- or +) button to scroll to the desired CID record.
- Press the MEMORY button.
- Use the touch-tone pad to enter a memory location (0-9) to store the number in that memory location. You will hear a confirmation tone.

NOTE: If the memory location is occupied, the screen displays REPLACE MEMO?, and you must confirm replacement by pressing the MEMORY button.

NOTE: Press the TONE*/exit button once to keep the previous setting (making no changes) and return to the menu.

NOTE: If the selected CID record contains any information that is non-numeric, the unit will not allow this record to transfer to the internal user memory. The screen of the handset displays UNABLE TO STORE.

To Replace a Stored CID Record

- Repeat steps 1 through 3 in Storing CID Records in Internal Memory. After you enter the memory location, the screen displays ***REPLACE MEMO?***
- Press the MEMORY button again, and the new CID record replaces the old memory in that location. You will hear a confirmation tone.

Deleting a CID Record

- Make sure the phone is **OFF** (not in TALK mode).
- Use the CID/VOL (- or +) button to display the CID record you want to delete.
- Press CHAN/delete. The screen displays ***DELETE CALL ID?***
- Press CHAN/delete again to erase the record and the screen displays the next Caller ID record. You will hear a confirmation tone.

NOTE: Press the TONE*/exit key to return to the standby mode.

Deleting All CID Records

- Make sure the phone is **OFF** (not in TALK mode).
- Use the CID/VOL (- or +) button to display any Caller ID record.
- Press and hold the CHAN/delete button until the screen displays ***DELETE ALL?***

- Press CHAN/delete again to erase all records. You will hear a confirmation tone. The screen displays ***NO CALLS***.

NOTE: Press the TONE*/exit key to return to the standby mode.

Memory

Each handset can store up to ten 24-digit numbers with up to 15-character names in memory for quick dialing. This memory feature is in addition to the CID memory log, which stores up to 40 CID records in each handset.

Storing a Name and Number in Memory

- Make sure the phone is **OFF** (not in TALK mode).
- Press the MEMORY button.
- Press the desired memory location (0 through 9) or use CID/VOL (+ or -) to scroll to the desired memory location.

NOTE: If the memory location is occupied, the memory location number and stored name and the screen displays the telephone number. If the memory location is empty, the screen displays EMPTY.

- Press the MEMORY button again. The screen displays ***ENTER NAME***.
NOTE: If you don't want to enter the name, skip step 5.
- Use the touch-tone pad on the handset to enter the name (up to 15 characters) and press the memory button to save. More than one letter is stored in each of the number keys. For example, to enter the name Bill Smith, press the 2 key twice for the letter B. Press the 4 key 3 times for the letter I. Press the 5 key 3 times for the letter L. Wait for one second. Press the 5 key 3 times for the second letter L. Press the 1 key to insert a space between the L and the S. Press the 7 key 4 times for the letter S; press the 6 key once for the letter M; press the 4 key 3 times for the letter I; press the 8 key for the letter T; press the 4 key twice for the letter H.

NOTE: If you make a mistake press the DELETE/Channel button to backspace and erase the wrong character(s) or number(s).

- Press the MEMORY button to save the name. The screen displays ***ENTER TEL NUMBR***.
- Use the touch-tone pad to enter the telephone number you want to store (up to 24 digits).
NOTE: The system treats PAUSES as delays or spaces in the dialing sequence.
- Press MEMORY again to store the number. You will hear a confirmation tone.

Storing the Last Number Dialed

- Repeat steps 1 through 6 in Storing a Name and Number in Memory.
- Press the REDIAL button.
- Press the MEMORY button to store the number. You will hear a confirmation tone.

To replace an old number with a new redial number:

- Repeat steps 1 through 6 in Storing a Name and Number in Memory.
- Press the REDIAL button.
- Press the MEMORY button, and the screen displays ***REPLACE MEMO?***
- Press the MEMORY button again to replace the old number with the new number. You will hear a confirmation tone.

Inserting a Pause in the Dialing Sequence of a Stored Number

If a pause is needed to wait for a dial or access tone, press the #PAUSE button to insert a delay in dialing sequence of a stored number (for example, after you dial 9 for an outside line, or to wait for a computer access tone). The screen displays *Pause as a P*, and each pause counts as one digit in the dialing sequence.

Changing a Stored Number

- Repeat steps 1 through 7 in Storing a Name and Number in Memory.
- Press the MEMORY button, and the screen displays ***REPLACE MEMO?***
- Press the MEMORY button to store the number. You will hear a confirmation tone.

Reviewing and Deleting Stored Numbers

- To review stored numbers, press the MEMORY button, and use the CID/VOL (- or +) button to scroll to the memory location, or press the corresponding number key for a desired memory location (0-9).
- When the screen displays the data, press the CHAN/delete button. The screen displays ***DELETE?***
- Press CHAN/delete again to delete the data. The screen displays ***DELETED***.

Dialing a Stored Number

- Make sure the phone is **ON** by pressing the TALK/call back button.
- Press the MEMORY button.
- Press the memory location (0-9). The number dials automatically.
- OR -

- Make sure the phone is **OFF** (not in TALK mode).
- Press the MEMORY button.
- Use the touch-tone pad or the CID/VOL (- or +) button to scroll to the number you want to dial.
- Press the TALK/call back button. The number dials automatically.

Chain Dialing from Memory

Use this feature to make calls which require a sequence of numbers, such as calling card calls to a frequently called long distance number. Each part of the sequence is dialed from memory. The following example shows you how to use chain dialing to make a call through a long distance service:

The Number For	Memory Location
Long distance access number	7
Authorization code	8
Frequently called long distance number	9

- Make sure the phone is **ON** (in TALK mode).
- Press the MEMORY button and then press 7.
- When you hear the access tone, press the MEMORY button and then press 8.
- At the next access tone, press the MEMORY button and then 9.

TIP: Wait for the access tones before pressing the next MEMORY button, or your call may not go through.

Changing the Battery

⚠ CAUTION: To reduce the risk of fire or personal injury, use only the Thomson Inc. approved Nickel-Cadmium (Ni-Cd) battery model 5-2459 or Nickel-metal Hydride (Ni-MH) model 5-2522, which is compatible with this unit.

- Make sure the telephone is **OFF** (not in TALK mode) before you replace battery.
- Remove the battery compartment door.
- Disconnect the cord attached to the battery pack and remove the battery pack from the handset.
- Insert the new battery pack and connect the cord to the jack inside the battery compartment.
- Put the battery compartment door back on.
- Place handset in the base to charge. **Allow the handset battery to properly charge (for 16 hours) prior to first use or when you install a new battery pack. If you do not properly charge the phone, battery performance will be compromised.**

Battery Safety Precautions

- Do not burn, disassemble, mutilate, or puncture. Like other batteries of this type, toxic materials could be released which can cause injury.
- To reduce the risk of fire or personal injury, use only the **Nickel-Cadmium** or **Nickel-metal Hydride (Ni-MH)** battery listed in the User's Guide.
- Keep batteries out of the reach of children.
- Remove batteries if storing over 30 days.

NOTE: The RBRC seal on the battery used in your Thomson Inc. product indicates that we are participating in a program to collect and recycle the rechargeable battery (or batteries). For more information go to the RBRC web site at www.rbrc.org or call 1-800-8-BATTERY or contact a local recycling center.

Display Messages

The following indicators show the status of a message or of the unit.

BLOCKED CALL	The person is calling from a number that has been blocked from transmission.
BLOCKED NAME	The persons name is blocked from transmission.
BLOCKED NUMBER	The person is calling from a number that has been blocked from transmission.

CALL WAITING	Indicates a call is waiting on the line.
DELETE ALL?	Prompt asking if you want to erase all Caller ID records.
DELETE CALL ID?	Prompt asking if you want to erase a Caller ID record.
DELETED	Prompt confirming the Caller ID record is erased.
EMPTY	Indicates a memory location is vacant.
END OF LIST	Indicates that there is no additional information in Caller ID memory.

ENTER NAME	Prompt telling you to enter the name for one of the 10 memory locations.
-------------------	--

ENTER NUMBER	Prompt telling you to enter the telephone number for one of the 10 memory locations.
---------------------	--

INCOMPLETE DATA	Caller information has been interrupted during transmission or the telephone line is excessively noisy.
------------------------	---

LOW BATTERY	Indicates the battery needs to be charged.
NEW	Indicates call or calls have not been reviewed.
NO CALLS	Indicates no calls have been received.
NO DATA	No Caller ID information was received.
PAGING	The PAGE button has been pressed on the base.
PRESS TALK KEY	Indicates the CID number is a Direct Dial Number (DDN) and cannot be formatted.

REPT	Repeat call message. Indicates that a new call from the same number was received more than once.
-------------	--

TRANSFERRING	The handset is transferring a call or receiving notice to accept a transferred call.
---------------------	--

UNKNOWN NAME/ CALLER/NUMBER	The incoming call is from an area not serviced by Caller ID or the information was not sent.
------------------------------------	--

Handset Sound Signals

Signal	Meaning
A long warbling tone (with ringer on)	Signals an incoming call
Three short beeps (several times)	Page signal
Single beep every 7 seconds	Low battery warning

Troubleshooting Guide

Caller ID Solutions

No Display

- The battery must be fully charged. Try replacing the battery.
- Make sure that the unit is connected to a non-switched electrical outlet. Disconnect the unit from the wall and plug it in again.
- You must be subscribed to Caller ID service from your local telephone company in order to receive Caller ID records.

Caller ID Error Message

- The unit displays this message if it detects anything other than valid Caller ID information during the silent period after the first ring. This message indicates either the presence of noise on the line, or that an invalid message has been sent from the telephone company.

Cordless Phone Solutions

No dial tone

- Check installation:
 - Make sure the base power cord is connected to a working electrical outlet.
 - Make sure the telephone line cord is connected to the base unit and the wall phone jack.
- Connect another phone to the same modular jack; if the second phone doesn't work, the problem might be with your wiring or local service.
- The handset may be out of range of the base. Move closer to the base.
- Make sure the battery is properly charged (for 16 hours).
- Ensure the battery pack is installed correctly.
- Did the handset beep when you pressed the TALK/call back button? Did the in use/charge indicator come on? The battery may need to be charged.
- Place the handset in the base for at least 20 seconds.

Handset does not ring

- Make sure the RINGER on the handset is turned ON.
- Move closer to the base. The handset may be out of range.
- You may have too many extension phones on your line. Try unplugging some phones.
- Check for a dial tone.

You experience static, noise, or fading in and out

- Change channels.
- Move closer to base. The handset might be out of range.

- Relocate the base. Make sure base is not plugged into an electrical outlet with another household appliance.
- Charge the battery.

Unit beeps

- Place handset in base for 20 seconds; if it still beeps, charge battery for 16 hours.
- Clean the charging contacts on handset and base with a soft cloth.
- See solutions for "No dial tone."
- Replace the battery.

Memory Dialing doesn't work

- Make sure you programmed the memory location keys correctly.
- Did you follow proper dialing sequence?

Phone dials in pulse with tone service

- Make sure phone is in tone dialing mode.

Phone won't dial out with pulse service

- Make sure phone is in pulse dialing mode.

Warranty Assistance

If trouble is experienced with this equipment, for warranty information, please contact customer service at **1-800-448-0329**. If the equipment is causing harm to the telephone network, the telephone company may require that you disconnect the equipment until the problem is resolved.

Any unauthorized repairs, changes or modifications not expressly approved by Thomson Inc. could void the user's authority to operate this product. For instructions on how to obtain a replacement unit, refer to the warranty included in this guide or call customer service at **1-800-448-0329**.

Or refer inquiries to:

Thomson Inc. Manager, Consumer Relations P O Box 1976 Indianapolis, IN 46206

Attach your sales receipt to this booklet for future reference or jot down the date this product was purchased or received as a gift. This information will be valuable if service should be required during the warranty period.

Purchase date _____
Name of store _____

Accessory Information

DESCRIPTION	MODEL NO.
AC Power adaptor/black	5-2616 or 5-2749
AC Power adaptor/gray	5-2617 or 5-2748
Handset Replacement Battery	5-2459 or 5-2522

To place order, have your Visa, MasterCard, or Discover Card ready and call toll-free 1-800-338-0376.

A shipping and handling fee will be charged upon ordering. We are required by law to collect appropriate sales tax for each individual state, country, and locality to which the merchandise is being sent. Items are subject to availability.

*Prices are subject to change without notice.

Limited Warranty

What your warranty covers:

- Defects in materials or workmanship.

For how long after your purchase:

- One year, from date of purchase. (The warranty period for rental units begins with the first rental or 45 days from date of shipment to the rental firm, whichever comes first.)

What we will do:

- Provide you with a new unit. The exchange unit is under warranty for the remainder of the original product's warranty period.

How you get service:

- Properly pack your unit. Include any cables, etc., which were originally provided with the product. We recommend using the original carton and packing materials.
- "Proof of purchase in the form of a bill of sale or receipted invoice which is evidence that the product is within the warranty period, must be presented to obtain warranty service." For rental firms, proof of first rental is also required. Also print your name and address and a description of the defect. Send via standard UPS or its equivalent to:

Thomson Inc. 11721 B Alameda Ave. Socorro, Texas 79927

- Insure your shipment for loss or damage. Thomson Inc. accepts no liability in case of damage or loss.
- A new unit will be shipped to you freight prepaid.

What your warranty does not cover:

- Customer instruction. (Your Owner's Manual provides information regarding operating instructions and user controls. Any additional information, should be obtained from your dealer.)
- Installation and setup service adjustments.
- Batteries.
- Damage from misuse or neglect.
- Products which have been modified or incorporated into other products.
- Products purchased or serviced outside the USA.
- Acts of nature, such as but not limited to lightning damage.

Product Registration:

- Please complete and mail the Product Registration Card packed with your unit. It will make it easier to contact you should it ever be necessary. The return of the card is not required for warranty coverage.

Limitation of Warranty:

- THE WARRANTY STATED ABOVE IS THE ONLY WARRANTY APPLICABLE TO THIS PRODUCT. ALL OTHER WARRANTIES, EXPRESS OR IMPLIED (INCLUDING ALL IMPLIED WARRANTIES OF MERCHANTABILITY OR FITNESS FOR A PARTICULAR PURPOSE) ARE HEREBY DISCLAIMED. NO VERBAL OR WRITTEN INFORMATION GIVEN BY THOMSON INC., ITS AGENTS, OR EMPLOYEES SHALL CREATE A GUARANTY OR IN ANY WAY INCREASE THE SCOPE OF THIS WARRANTY.**
- REPAIR OR REPLACEMENT AS PROVIDED UNDER THIS WARRANTY IS THE EXCLUSIVE REMEDY OF THE CONSUMER. THOMSON INC. SHALL NOT BE LIABLE FOR INCIDENTAL OR CONSEQUENTIAL DAMAGES RESULTING FROM THE USE OF THIS PRODUCT OR ARISING OUT OF ANY BREACH OF ANY EXPRESS OR IMPLIED WARRANTY ON THIS PRODUCT. THIS DISCLAIMER OF WARRANTIES AND LIMITED WARRANTY ARE GOVERNED BY THE LAWS OF THE STATE OF INDIANA. EXCEPT TO THE EXTENT PROHIBITED BY APPLICABLE LAW, ANY IMPLIED WARRANTY OF MERCHANTABILITY OR FITNESS FOR A PARTICULAR PURPOSE ON THIS PRODUCT IS LIMITED TO THE APPLICABLE WARRANTY PERIOD SET FORTH ABOVE.**

How state law relates to this warranty:

- Some states do not allow the exclusion nor limitation of incidental or consequential damages, or limitations on how long an implied warranty lasts so the above limitations or exclusions may not apply to you.
- This warranty gives you specific legal rights, and you also may have other rights that vary from state to state.

If you purchased your product outside the USA:

- This warranty does not apply. Contact your dealer for warranty information.