

~ YOU MUST
SUBSCRIBE TO YOUR
NETWORK PROVIDER'S CALLER
DISPLAY SERVICE BEFORE THIS
FEATURE WILL WORK



User Guide

BT FREESTYLE 2000 HANDSET & ALARM CLOCK RADIO CHARGER

This equipment is not designed for making emergency telephone calls when the power fails. Alternative arrangements should be made for access to emergency services.

This product is intended for connection to analogue public switched telephone networks and private switchboards in the United Kingdom.



**Please open this page for an 'at a glance' guide to your
Freestyle 2000 Handset & Alarm Clock Radio Charger**



Please open this page for a further 'at a glance' guide to your Freestyle 2000 Handset & Alarm Clock Radio Charger



At a glance

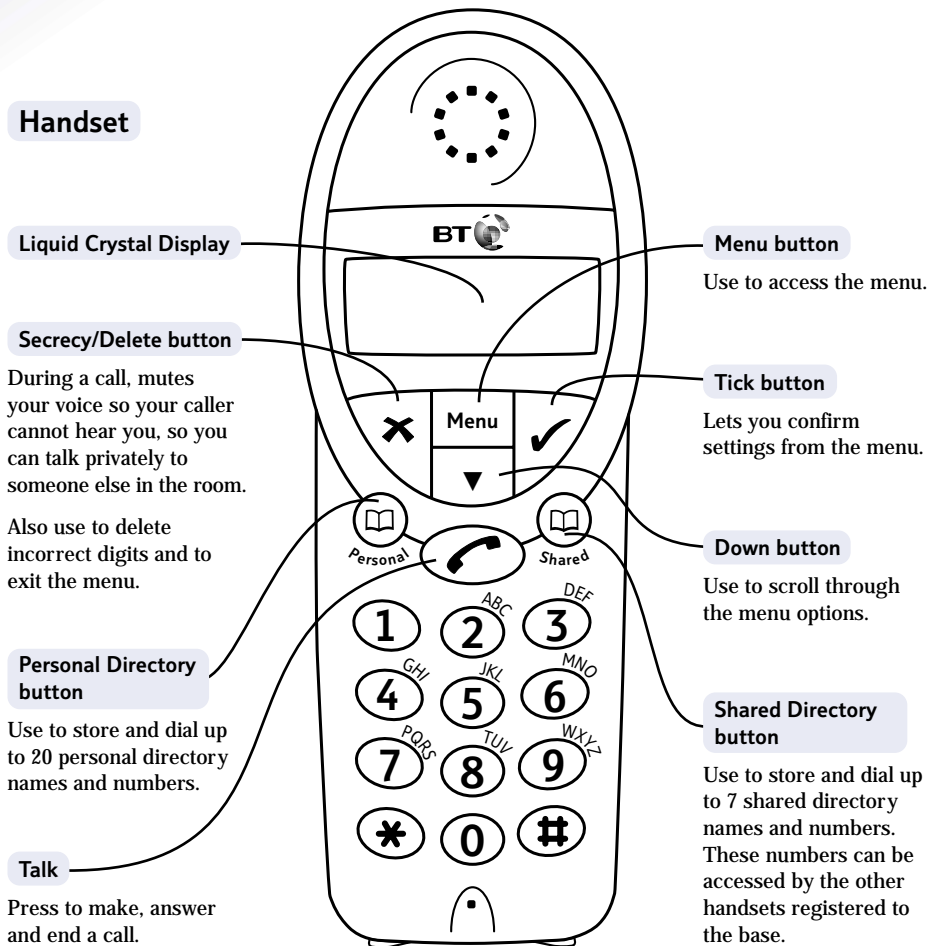

Alarm Clock Radio Charger

Please refer to the separate 'Freestyle Alarm Clock Radio and Charger user guide' for information on how to use it.

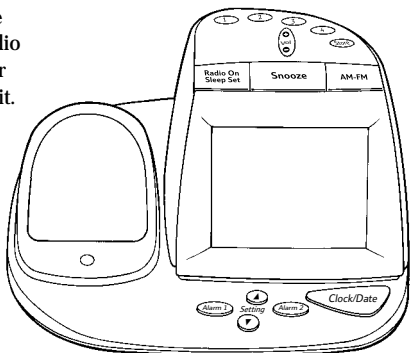

Explanation of the display icons







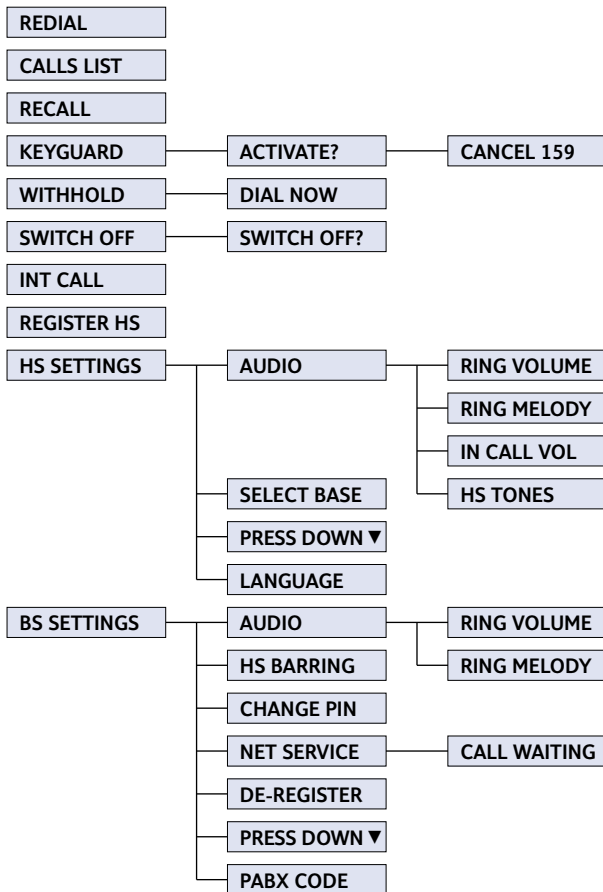





















Steady		Flashing	
	Handset in use		Incoming call
	Battery exhausted		Battery low
	Battery one third full		
	Battery two thirds full		
	Battery full		
ABCD	Handset linked to base station		Flashes when out of range
	Secrecy		

Quick guide to the menu structure



Quick guide

Information for the handset settings

Function	Key combination
Answer/End a call	 *
Make a call	 
Redial a number	   to scroll through the list 
Store a name and number in the personal directory	   Enter telephone number  Enter name 
Dial a number in the directory	  to scroll 
Adjust the earpiece volume	During a call   to IN CALL VOL   until the required level is reached 
Secrecy on/off	During a call 
Switch handset off	  to SWITCH OFF  
Switch handset on	

Important

* If the handset is sitting in the base when a call comes in you can pick it up and answer it automatically without pressing the  button.

If you make a mistake you can return to the previous menu by pressing the **X** button. If you keep pressing the **X** button you will return to the standby screen.

In this guide

Please note

There is a detailed Index at the end of this guide, see page 30.

At a glance	1	Handset settings	22
Quick guide to the menu structure	3	Help	26
Quick guide for the handset settings	4	General information	28
Introduction	6	<i>Guarantee</i>	28
<i>Unpacking your Freestyle 2000</i>	7	<i>Technical information</i>	29
<i>For your records</i>	7	<i>Switchboard compatibility</i>	29
Safety information	8	Index	30
Setting up	9		
Using your Freestyle 2000	12		
<i>Making and receiving calls</i>	12		
<i>Secrecy</i>	13		
<i>Internal calls</i>	14		
<i>Redial</i>	15		
<i>Name and number directory</i>	17		

Please note

In this user guide, we've included helpful tips and useful notes. They are shown in a white box like this.

Introduction

Your Freestyle 2000 has been designed for ease of use and made to the high standards set by BT

Please read the instructions carefully before use and retain this user guide for future reference.

The internal call functions described in this guide apply to your base station if you have more than one handset connected.

Your Freestyle 2000 handset comes with an Alarm Clock Radio Charger. You should refer to the separate user guide 'Freestyle Alarm Clock Radio and Charger' for instructions on how to use it.

DECT

By purchasing the Freestyle 2000 you now own a product which combines the advantages of cordless operation with the performance of a high quality corded telephone. It complies with the Digitally Enhanced Cordless Telecommunications (DECT) standard and offers unparalleled quality and features.

Registering your handset

You **MUST** register your Freestyle 2000 handset to your existing DECT GAP compatible base station for the handset to work. There may be limited availability of some functions.

Unpacking your Freestyle 2000

If anything is missing, please contact your place of purchase immediately.

- Freestyle 2000 handset.



- Freestyle Alarm Clock Radio Charger.



- 2 x AAA rechargeable handset batteries (packed with battery cover)

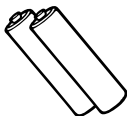

- Alarm Clock Radio plug mounted, DC 6.0V mains adaptor.

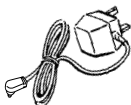

For your records

Date of purchase:

Place of purchase:

Serial number (on the underside of telephone base):

Purchase price:

For guarantee purposes, proof of purchase is required, so please keep your receipt.

Customer Helpline

If you experience any difficulties with your Freestyle 2000, please contact the Freestyle Helpline on 0870 240 3962 or email: bt.freestyle.helpdesk@vtecheurope.com

Safety information

General

Only use the power supply included with the product marked Alarm Clock Radio. Using an unauthorised power supply will invalidate your guarantee and may damage the telephone.

Only use the approved rechargeable batteries supplied. Spare rechargeable batteries – are available from the Freestyle Helpline **0870 240 3962**.

If the keypad is locked, it is **STILL** possible to make emergency calls to 999 and 112.

Do not open the handset (except to replace the handset batteries) or charger. This could expose you to high voltages or other risks. Contact the Helpline for all repairs.

Radio signals transmitted between the handset and base may cause interference to hearing aids.

It is recommended that advice from a qualified expert be sought before using this product in the vicinity of emergency/intensive care medical equipment.

It is recommended that if you have a pacemaker fitted you check with a medical expert before using this product.

Never dispose of batteries in a fire.

There is a serious risk of explosion and/or the release of highly toxic chemicals.

Cleaning

Simply clean the handset and charger with a damp (not wet) cloth, or an antistatic wipe. Never use household polish as this will damage the product. Never use a dry cloth as this may cause a static shock.

Environmental

Do not expose to direct sunlight.

The product may heat up when the batteries are being recharged or during prolonged periods of use. This is normal. However, we recommend to avoid damage you do not place the product on antique/veneered wood.

Do not stand your product on carpets or other surfaces which generate fibres, or place it in locations preventing free flow of air over its surfaces.

Do not submerge any part of your product in water and do not use it in damp or humid conditions, such as in bathrooms.

Do not expose your product to fire, explosive or other hazardous conditions.

There is a slight chance that your phone could be damaged by an electrical storm. We recommend that you unplug the power and telephone line cord for the duration of the storm.

Setting up

Follow these steps to set up your Freestyle 2000 ready for use

Plan the location of your Freestyle 2000

The following points should be considered:

- Situate your product close enough to the power socket so that the cable will reach safely without stretching. Ensure that you plan the location so that the mains power is easily accessible in case you need to disconnect the power.
- Make sure it is at least 1 metre away from other electrical products to avoid interference.

Please note

The Freestyle 2000 has a range of up to 300 metres outdoors and up to 50 metres indoors. The range will be reduced when there is no clear line of sight between the base and handset. Thick stone walls can severely affect the range.

1 Connect the power cable

Plug the power cable into the power socket on the back of your Freestyle Alarm Clock Radio Charger.

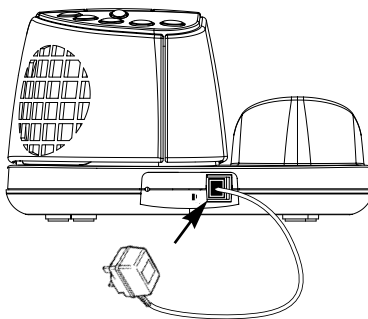

Plug the adaptor into the mains power supply and switch on.

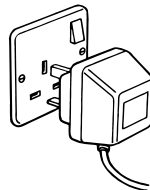

For more information on the charger, please refer to the separate 'Freestyle Alarm Clock Radio and Charger user guide'.

2 Install the rechargeable batteries in the handset

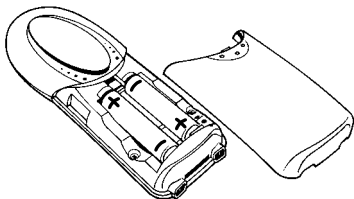

The handset uses two rechargeable Nickel Metal Hydride (Ni-MH) AAA batteries which are supplied. Take care to insert the batteries as shown and then fit the battery cover (the battery cover may be found in the packaging with the batteries).

3 Charge the handset batteries for at least 16 hours

Before you use your Freestyle 2000 for the first time, it is important to have the handset batteries fully charged. The batteries need to charge continuously for at least 16 hours to reach full charge.

Place the handset on the Alarm Clock Radio Charger and leave to charge for at least 16 hours.

The battery symbol is also shown on the display. It flashes during charging. Once the handset is fully charged, the display shows a full battery symbol and REGISTER!

Battery levels

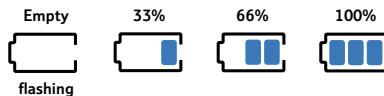

Battery low warning

If the handset battery symbol is empty and flashing, and you hear a warning beep every 10 seconds, you will need to recharge your handset before you can use it.

Battery performance

Under no circumstances should non-rechargeable batteries be used. Only use the approved batteries, type: rechargeable Nickel Metal Hydride (NiMH); Size AAA; Capacity 600 mAh. Using unapproved batteries will invalidate your guarantee and may damage the telephone.

To keep your batteries in the best condition, leave the handset off the charger for a few hours at a time (after the initial 16 hour charge).

Please note, however, that new Nickel Metal Hydride (Ni-MH) batteries do not reach their full capacity until they have been in normal use for several days.

Fully discharging the batteries at least once a week will help them to last as long as possible. However, the charge capacity of rechargeable batteries will reduce with time as they wear out, so reducing the talk/standby time of the handset. Eventually they will need to be replaced.

Please note

Under ideal conditions, the handset batteries should give about 12 hours talktime or 120 hours standby on a single charge. Optimum times for talk and standby are only achieved when the handset batteries are new and fully charged.

4

Registering the handset to the base station

Page



At the base station:

Press and hold the **PAGE** button until it beeps (about 10 seconds).

At the handset:

Menu



Press the **MENU** button.

The display will show **REDIAL**.



Press the **DOWN** button until the display shows **REGISTER HS**.



Press the **✓** button.

The display will show **BASE A**.



Use the **DOWN** button to display the base you want to register the handset to e.g. **A**, **B**, **C** or **D**.

(It is not important which one you choose, but it is suggested that you use the same letter/number as that shown on the other handsets registered to this base.)



Press the **✓** button to confirm.

The display will show a flashing cursor and **ENTER PIN**.



Enter your PIN (factory setting 0000).



Press the **✓** button to confirm.

The display will show **SEARCHING** and the letter/number of the chosen base will flash.

When registration is complete, the display will show the handset name and number.

Please note

*If the display shows NO BASE it means that the handset could not find the base that you selected. Please ensure that the base you are registering to is within range and switched on, and that you hold the **PAGE** button until it beeps before selecting the base on the handset. If the display shows NOT POSSIBLE it means that there are already 5 handsets registered to the base. You will need to de-register one of the other handsets before you can register another one.*

Customer Helpline

If you experience any difficulties in installing your Freestyle 2000 please contact the Freestyle Helpline on 0870 240 3962 or email: - bt.freestyle.helpdesk@vtecheurope.com

Using your Freestyle 2000 telephone

Please note

*To exit and return to the previous menu at any time, press the **X** button. If you keep pressing the **X** button you will return to the standby screen.*

The number is shown on the display. (If you make a mistake you can delete a digit by pressing the **X** button)

When you have entered the number correctly, press the **TALK** button to dial the number.

Making and receiving calls

To make a call



Press the **TALK** button. The display will show the  icon and you will hear the dial tone.



Enter the telephone number. The number is dialled automatically.



Press the **TALK** button.

Or

Place the handset back in the charger.

Preparatory dialling

Preparatory dialling allows you to enter the number before pressing the **TALK** button. This enables you to correct any mistakes before you actually make the call.



First enter the telephone number to be dialled.

To receive a call

When the telephone rings the display will show **CALL** and the  icon will flash.

If you have subscribed to a Caller Display Service your caller's number will be shown (or the name if it is stored in your directory).



Press the **TALK** button or pick the handset up from the base to answer the call.

To withhold your number when making a call

If you do not want your telephone number sent to the person you are calling you can withhold it. You will need to do this each time you make a call, this includes using redial.



Press the **MENU** button.

The display will show **REDIAL**.



Press the **DOWN** button until the display shows **WITHHOLD**.



Press the **✓** button.

The display will show **DIAL NOW**.



Enter the number you want to dial.



Press the **TALK** button.

The withhold code will be dialled and then the telephone number.

To adjust the speech volume during a call

During a call you can adjust the speech volume of your caller. There are 3 volume levels: low ■, medium ■■ and high ■■■.

During a call:



Press the **MENU** button. (You need to wait until a forward arrow ► appears in the display.)



Press the **DOWN** button until the display shows **IN CALL VOL**.



Press the **✓** button.

The display will show the current level with a tick on the right of the display, ie, ■■■■✓.



Press the **DOWN** button to increase the volume.



Once the maximum level is reached, press the **DOWN** button to return to the lowest level.



When you have reached the level you require, press the **✓** button. The volume will not change until the **✓** is pressed.

The display will show **STORED**.

Secrecy

When on a call you can talk to someone in the same room without your caller hearing.

To switch secrecy on and off

During a call:



Press the **X** button. The display will show the icon. Your caller cannot hear you.



Press the **X** button again to return to your caller.

Internal calls

To make an internal call to another handset

Menu

Press the **MENU** button.

The display will show **REDIAL.**



Press the **DOWN** button until the display shows **INT CALL.**



Press the **✓** button.

The display will show a flashing cursor and **INTERN NBR.**



Enter the handset number you want. The called handset will ring.



To end the call, press the **TALK** button.

Inquiry calls, transferring calls and conference calls

During a call you can contact another Freestyle handset (which is registered to your base station) without losing the initial call. You can then speak to either party independently, have a 3-way conversation or you can transfer the call to the other handset.

During a call:

Menu

Press the **MENU** button. (You need to wait until a forward arrow ► appears in the display.)

The display will show **INQUIRY.**



Press the **DOWN** button until the display shows **INTERN INQ.**



Press the **✓** button.

The display will show **INTERN NBR.**



Enter the number of the handset you want to contact (e.g. if the other handset is Freestyle 3, enter a **3**). The display on your handset will show the name and number of the called handset and the other handset will ring (the original call will be put on hold).



When the other handset answers, (if it doesn't answer, press the **TALK** button to return to your original call) you can hold a conversation whilst your original call is on hold. If the second handset hangs up you will be returned to your original call.

Menu

Whilst talking to the second handset press the **MENU** button.

The display will show **TRANSFER.**



You can now press the **DOWN** button to reveal the other options – **CONFERENCE** and **SWAP CALLS.**



Press the **✓** button to select the displayed option.

Selecting **TRANSFER** will send the original call to the other handset.

Selecting **CONFERENCE** will bring the other handset in on the original call with you.

Selecting **SWAP CALLS** will switch you back to the original call but keep the other handset on hold (select **SWAP CALLS** again to go back to the other handset).

If you subscribe to BT's Three Way Calling Service you can perform similar functions to contact another external number (instead of another Freestyle handset).

During a call:



Press the **MENU** button. (You need to wait until a forward arrow ► appears in the display.)



The display shows **INQUIRY**.

Press the **✓** button.

The display shows **-NUMBER**.

Enter the telephone number you want to contact.



Press the **✓** button.

When the number you have called answers (if it doesn't answer, press the **TALK** button to return to your original call) you can hold a conversation whilst your original call is on hold. If the second call hangs up you will be returned to your original call. Whilst on the second call, press the **MENU** button. The display shows **CONFERENCE**.



You can now press the **DOWN** button to reveal the other options – **SWAP CALLS** and **RECALL**.



Press the **✓** button to select the displayed option.

Selecting **CONFERENCE** will bring the other party in on the original call with you.

Selecting **SWAP CALLS** will switch you back to the original call but keep the other call on hold (select **SWAP CALLS** again to go back to the other call).

You can select **RECALL** to perform other Three Way Calling Functions (See your Three Way Calling User Guide).

Redial

Your handset automatically saves the last 8 numbers dialled into a redial list.

To view and dial a number in the redial list



Press the **MENU** button.



The display will show **REDIAL**.

Press the **✓** button.

The last number called will be displayed.



Use the **DOWN** button to scroll through and view the numbers in the redial list.



Press the **TALK** button to dial the number displayed.

To edit and then call a number in the redial list



Press the **MENU** button.

The display will show **REDIAL**.



Press the **✓** button.

The last number called will be displayed.



Use the **DOWN** button to scroll through to the number you want to edit.



Press the **MENU** button.

The display will show **CHANGE**.



Press the **✓** button.



Use the **X** button to delete unwanted digits and re-enter the correct ones using the keypad.



Press the **✓** button to dial the number.

The edited number will be added to the redial list.

To delete a number in the redial list



Press the **MENU** button.

The display will show **REDIAL**.



Press the **✓** button.

The last number called will be displayed.



Use the **DOWN** button to scroll through to the number you want to delete.



Press the **MENU** button.

The display will show **CHANGE**.



Press the **DOWN** button until the display shows **DELETE**.



Press the **✓** button.

The display will show
? - DELETE --?



Press the **✓** button to confirm.
(Or if you decide not to delete, press the **X** button.)

The display will show **DELETED** and you will hear a confirmation beep.

To delete the whole redial list

Menu

Press the **MENU** button.

The display will show **REDIAL**.



Press the **✓** button.

The last number called will be displayed.

Menu

Press the **MENU** button.

The display will show **CHANGE**.



Press the **DOWN** button until the display shows **DELETE LIST**.



Press the **✓** button.

The display will show
? - DELETE -- ?



Press the **✓** button to confirm. (Or if you decide not to delete, press the **X** button.)

The display will show **DELETED** and then **EMPTY**. You will hear a confirmation beep.

Name and number directory

You can store up to 27 of your most frequently dialled names and numbers in your Freestyle 2000: 20 in the personal directory and 7 in the shared directory. Please note that names can be up to 11 characters and numbers up to 24 digits long.

Names and numbers in the shared directory can be accessed by other Freestyle handsets that are registered to your base.

To store a name and number in the personal directory



Press the **PERSONAL DIRECTORY** button.

The display will show **EMPTY** if there are no numbers stored.

Menu

Press the **MENU** button.

The display will show **NEW**.



Press the **✓** button.

The display will show a flashing cursor and **NUMBER** (or **FULL** if the directory is already full).



Enter the telephone number using the numbers on the keypad. (If you make a mistake, press the **X** button to delete incorrect digits and re-enter the correct ones).

Please note

If you subscribe to a Caller Display Service (please refer to the user guide for your main phone for further information) and want directory names to be displayed when a call is received from one of your directory numbers, you must ensure that you always enter the full telephone number, including the national code.



Press the **✓** button to confirm.

The display will show **STORED** and then a flashing cursor and **NAME**.



Enter the name using the letters on the keypad. (If you make a mistake, press the **X** button to delete incorrect letters and re-enter the correct ones). Please note that the figure 0 equals a space when using the keypad letters.

For example to enter the name TOM:-



To enter the letter T, press the **8** button. The cursor will automatically move to the right.



To enter the letter O, press the **6** button *three times*.

Wait for the cursor to move to the next position and then:-



To enter the letter M, press the **6** button.



Press the **✓** button to confirm.

The display will show **STORED** and you will hear a confirmation beep.



Press the **X** button until you return to the standby screen.

To store a name and number in the shared directory



Press the **SHARED DIRECTORY** button.

The display will show **EMPTY** if there are no numbers stored for each of the individual seven entries available.

Unless already displayed, press the **DOWN** button until display shows **EMPTY**.



Menu

Press the **MENU** button.

The display will show **CHANGE**.



Press the **✓** button.

The display will show a flashing cursor and **NUMBER**.

Enter the telephone number using the numbers on the keypad. (If you make a mistake, press the button to delete incorrect digits and re-enter the correct ones.)



Press the **✓** button to confirm.

The display will show **STORED** and then a flashing cursor and **NAME**.

Enter the name using the letters on the keypad. (If you make a mistake, press the **X** button to delete incorrect letters and re-enter the correct ones.)



For example to enter the name TOM:-



To enter the letter T, press the **8** button. The cursor will automatically move to the right.



To enter the letter O, press the **6** button *three times*. Wait for the cursor to move to the next position and then:-



To enter the letter M, press the **6** button.



Press the **✓** button to confirm.

The display will show **STORED** and you will hear a confirmation beep.



Press the **X** button until you return to the standby screen.

To enter a pause in a stored number

When storing a number, you can insert a pause in the number when the cursor is at the appropriate point, by pressing and holding the  button until a F appears in the display.

Please note that you can also program your Freestyle 2000 to automatically wait for a dial tone when connected to a switchboard, *see your user guide for your main phone for instructions.*

To dial a number in the directory



Press either the **PERSONAL** or **SHARED DIRECTORY** button.

The first entry will be shown.



Use the **DOWN** button to scroll through to the entry you want to dial.

Or



When using the personal directory, you can search alphabetically for names using the keypad. For example, pressing the **4** button once will take you to the first entry starting with **G**. Pressing the **4** button *three times* will take you to the first entry starting with **I**.



Press the **TALK** button to dial the number.

To edit an entry in the personal directory



Press the **PERSONAL DIRECTORY** button.

The first entry will be shown.



Use the **DOWN** button to scroll through to the entry you want to edit.



Press the **MENU** button. **NEW** will be displayed.



Press the **DOWN** button. The display will show **CHANGE**.



Press the  button.

The number will be shown. Use the  button to delete unwanted digits and re-enter the correct ones.



When the number is correct, press the  button.

The display will show **STORED** and you will hear a confirmation beep.



The display will then show the name. Edit the name.



Press the  button when the name is correct.

The display will show **STORED** and you will hear a confirmation beep.



Press the  button until you return to the standby screen.

To delete an entry in the personal directory



Press the **PERSONAL DIRECTORY** button.

The first entry will be shown.



Use the **DOWN** button to scroll through to the entry you want to delete.



Press the **MENU** button. **NEW** will be displayed.



Press the **DOWN** button until the display will show **DELETE**.



Press the **✓** button.
The display will show
? - DELETE -- ?



Press the **✓** button to confirm. (Or if you decide not to delete, press the **X** button).

The display will show **DELETED** and you will hear a confirmation beep.



Press the **X** button until you return to the standby screen.

To edit an entry in the shared directory



Press the **SHARED DIRECTORY** button.

The first entry will be shown.



Use the **DOWN** button to scroll through to the entry you want to edit.



Press the **MENU** button. **CHANGE** will be displayed.



Press the **✓** button.



The number will be shown. Use the **X** button to delete unwanted digits and re-enter the correct ones.



When the number is correct press the **✓** button.

The display will show **STORED** and you will hear a confirmation beep.

The display will then show the name.
Edit the name.



Press the **✓** button when the name is correct.

The display will show **STORED** and you will hear a confirmation beep.



Press the **X** button until you return to the standby screen.

To delete an entry in the shared directory



Press the **SHARED DIRECTORY** button.

The first entry will be shown.



Use the **DOWN** button to scroll through to the entry you want to delete.



Press the **MENU** button. **CHANGE** will be displayed.



Press the **DOWN** button until the display shows **DELETE**.



Press the **✓** button.

The display will show
? - **DELETE** - ?



Press the **✓** button to confirm. (Or if you decide not to delete, press the **X** button.)

The display will show **DELETED** and you will hear a confirmation beep.



Press the **X** button until you return to the standby screen.

Handset settings

To switch the handset off

Menu

Press the **MENU** button.

The display will show **REDIAL**.



Press the **DOWN** button until the display shows **SWITCH OFF**.



Press the **✓** button.

The display will show **SWITCH OFF?**



Press the **✓** button to confirm.

The display will go blank and the handset is now switched off.

To switch the handset on



Press the **TALK** button.

The display will show **SEARCHING** and then return to the standby screen.

To adjust the handset ringer volume

Menu

There are 5 handset ringer volume levels to choose from where **■** is the minimum and **■■■■■** is the maximum level.



Press the **MENU** button. The display will show **REDIAL**.



Press the **DOWN** button until the display shows **HS SETTINGS**.



Press the **✓** button.

The display will show **AUDIO**.



Press the **✓** button.

The display will show **RING VOLUME**.



Press the **✓** button.

Use the **DOWN** button to select the ringer volume level you require. You will hear a sample ring with each press. (The current level will have a **✓** next to it.) The volume will not change until the **✓** is pressed.



Press the **✓** button to select the setting. You will hear a confirmation beep.

The display will show **STORED** and then **RING VOLUME**.



Press the **X** button until you return to the standby screen.

To adjust the handset ringer melody

There are 6 handset ringer melodies to choose from MELODY 1-6.



Press the **MENU** button. The display will show REDIAL.



Press the **DOWN** button until the display shows HS SETTINGS.



Press the **✓** button.

The display will show AUDIO.



Press the **✓** button.

The display will show RING VOLUME.



Press the **DOWN** button until the display shows RING MELODY.



Press the **✓** button.



Use the **DOWN** button to select a melody (1-6). You will hear a sample melody on each press. (The current melody will have a **✓** next to it.)



Press the **✓** button to select the melody. You will hear a confirmation beep.

The display will show STORED and then RING MELODY.



Press the **X** button until you return to the standby screen.

To adjust the speech volume

There are 3 incoming speech volume levels to choose from where ■ is the minimum and ■■■■ is the maximum level. You can also adjust the speech volume during a call, *see page 13*.



Press the **MENU** button. The display will show REDIAL.



Press the **DOWN** button until the display shows HS SETTINGS.



Press the **✓** button.

The display will show AUDIO.



Press the **✓** button.

The display will show RING VOLUME.



Press the **DOWN** button until the display shows IN CALL VOL.



Press the **✓** button.



Use the **DOWN** button to select the speech volume you require. (The current volume level will have a **✓** next to it.)



Press the **✓** button to select the volume level. The volume will not change until the **✓** button is pressed. You will hear a confirmation beep.

The display will show STORED and then IN CALL VOL.



Press the **X** button until you return to the standby screen.

To switch the keypad on and off

You can lock the handset keypad to prevent accidental button presses.

Menu

Press the **MENU** button.

The display will show **REDIAL**.



Press the **DOWN** button until the display shows **KEYGUARD**.



Press the **✓** button.

The display will show **ACTIVATE?**



Press the **✓** button to confirm.

You will hear a confirmation beep and the display will show **CANCEL 159**.



To switch the keypad off, enter **159** using the keypad.

The display will return to the standby screen.

To switch the handset beeps off and on

The handset will beep:

- If the battery is low.
- If you go out of range of the base whilst on a call.
- Each time you press a button.

You can switch any of the above beeps off and on independently.

Menu

Press the **MENU** button.

The display will show **REDIAL**.



Press the **DOWN** button until the display shows **HS SETTINGS**.



Press the **✓** button.

The display will show **AUDIO**.



Press the **✓** button.

The display will show **RING VOLUME**.



Press the **DOWN** button until the display shows **HS TONES**.



Press the **✓** button. The display will show **LOW BATTERY**.



Use the **DOWN** button to select either **BATTERY LOW**, **NO SIGNAL** or **KEY BEEPS** depending on which beeps you want to switch off or on.



When the option you want is displayed, press the **✓** button to confirm.



Use the **DOWN** button to select either **ON** or **OFF** (the current setting will have a **✓** next to it).



Press the **✓** button to confirm.

The display will show **STORED** and then the option you have changed.



Press the **X** button to return to the standby screen.

Please note

When the handset beeps are switched off, the confirmation beeps you hear when you select a menu option will also be switched off.

Handset Factory settings:	
Earpiece volume	2
Handset ringer volume	5
Handset melody	1
Keyguard	OFF
Keypad beeps	ON
Battery low beep	ON
Out of range beep	ON
Dialling mode	DTMF
Pause after picking up line/Dial-out code	3 seconds
Personal directory	Empty
Redial list	Empty
Calls list	Empty

Customer Helpline

If you experience any difficulties with your Freestyle 2000, please contact the Freestyle Helpline on 0870 240 3962 or email: bt.freestyle.helpdesk@vtecheurope.com

Help

Replacing the handset batteries

After a time, you may find that the handset batteries are running out of charge more quickly. This is a standard sign of wear and the batteries will need replacing.

Slide the battery compartment cover off as shown. Take out the old batteries and replace with new batteries. Only use the approved batteries, *see page 10 for details*.

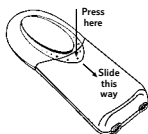

Spare rechargeable batteries are available from the Freestyle 2000 Helpline **0870 240 3962**.

Do not immerse batteries in water or throw them into a fire, or dispose of them with ordinary domestic refuse.

BT accepts no responsibility for damage caused to your Freestyle handset by using any other types of batteries.

No display appears

The batteries may be flat, dead or incorrectly inserted. Recharge or replace the batteries.

The handset may be switched off.

No dial tone

Is the telephone line cord for the main base station plugged into the phone socket?

Check that the charger is connected to the mains power and switched on.

You cannot link up with the base station

Is the display flashing?

Check that the mains power cable is connected to the charger and switched on.

Are you in range of the base station?

Batteries could be low or flat.

If using more than one base station, check that you have the correct base selected.

Handset does not ring

The ringer volume may be switched to off. To adjust the ringer volume on the handset, *see page 22*.

Check that the main base station is plugged into the phone socket.

Check that the charger is plugged into the mains power and switched on.

Buzzing noise on my radio, TV, computer or hearing aid

Sometimes, your Freestyle 2000 can interfere with other electrical equipment if it is placed too close.

It is recommended that you place your Freestyle 2000 and other Freestyle handsets at least one metre away from such appliances to avoid any risk of interference.

The charger does not appear to be working

Check that:

- The power adaptor is properly plugged into the charger.
- Your handset has slotted correctly into the charger.
- The batteries are correctly fitted into the handset.

Are you using the correct power adaptor?
Freestyle 2000 power supply is Item Code 005977.

Customer Helpline

If you experience any difficulties with your Freestyle 2000, please contact the Freestyle Helpline on 0870 240 3962 or email:- bt.freestyle.helpdesk@vtecheurope.com

HELP

General information

Guarantee

Your Freestyle 2000 is guaranteed for a period of 12 months from the date of purchase.

Subject to the terms listed below the guarantee will provide for the repair of, or at BT's or its agent's discretion, the option to replace the Freestyle 2000, or any component thereof, (other than batteries), which is identified as faulty or below standard, or as a result of inferior workmanship or materials. Products over 28 days old from the date of purchase may be replaced with a refurbished product.

The conditions of this guarantee are:

- The guarantee shall only apply to defects that occur within the 12 month guarantee period.
- Proof of purchase is provided.
- The equipment is returned to BT or its agent as instructed.
- This guarantee does not cover any faults or defects caused by accidents, misuse, fair wear and tear, neglect, tampering with the equipment, or any attempt at adjustment or repair other than through approved agents.
- This guarantee does not affect your statutory rights.

Within the 12 month guarantee period:

If you experience difficulty using the product you should contact the Helpline on **0870 240 3962** or email:-

bt.freestyle.helpdesk@vtecheurope.com

If the problem is not remedied, you will be advised to return your product.

Outside of the 12 month guarantee period:

If your product needs repair after the guarantee period has ended, the repair must meet the approval requirements for connection to the telephone network. We recommend that you call the Helpline on **0870 240 3962** and ask for details of our recommended repair agents.

If you have to return your product:

If the Helpline is unable to remedy your problem they will ask you to return the product. Pack the charger and handset securely, preferably in the original packaging. All parts must be returned including power supply unit and the original batteries. (Please note that we cannot take responsibility for goods damaged in transit.) Please obtain and keep proof of posting from the Post Office.

Technical information

How many telephones can you have?

All items of telephone equipment have a Ringer Equivalence Number (REN), which is used to calculate the number of items which may be connected to any one telephone line. Your Freestyle 2000 has a REN of 1. A total REN of 4 is allowed, if the total REN of 4 is exceeded, the telephones may not ring.

With different telephone types there is no guarantee of ringing, even when the REN is less than 4.

Only use approved power supply.

Only use approved rechargeable batteries.

Switchboard compatibility

This product is intended for use within the UK for connection to the public telephone network and compatible switchboards, which support tone dialling and timed break recall. If in doubt please consult your switchboard maintainer.

Index

Batteries		Handset	
charging	10	beeps	24
install	10	call another handset	14
levels	10	keyguard	24
low warning	10	melody	23
performance	10	on/off	22
replacing	26	register	11
Calls		ringer volume	22
end	12	settings – Quick guide	4
inquiry	14	speech volume	13, 23
internal	14	three-way conversation	14
make	12	transfer external call	14
receive	12	Help	26
redial	15	Helpline	7
secrecy	13	Inquiry call	14
three-way conversation	14	Internal call	14
transfer	14	Keyguard on/off	24
withhold number	13	Location of product	9
Cleaning	8	Make a call	12
DECT	6	Melody – handset	23
Delete		Menu structure	3
directory entry	20, 21	On/Off	
Directory		handset	22
delete number	20, 21	handset beeps	24
dial a number	19	keyguard	24
edit a number	19, 20	secrecy	13
enter a pause	19	Pause	19
store name and number	17, 18	Power socket	9
Display icons	2		
End a call	12		
Guarantee	28		

Power cable	9
Preparatory dialling	12
Quick guide to handset settings	4
Quick guide to menu structure	3
R Receive a call	12
Redial	15
Register	
handset	11
REN (Ringer Equivalence Number)	29
Returning your Freestyle 2010	28
Ringer – handset volume	22
S afety information	8
Secrecy	13
Setting up	9
Speech volume	13, 23
Store a name and number	17, 18
Switchboard compatibility	29
T echnical information	29
Three-way conversation	14
Transfer a call	14
V olume	
handset ringer	22
speech volume	13, 23
W ithhold telephone number	13

Accessories and spares

For the Freestyle 2000 range of telephones

Accessories and spares for the Freestyle 2000 range of telephones are listed below.

All items are available from the Freestyle Helpline, please call **0870 240 3962** or email bt.freestyle.helpdesk@vtecheurope.com

Additional handsets and chargers:

In Silver:
Item code 006481



In Black:
Item code 005973

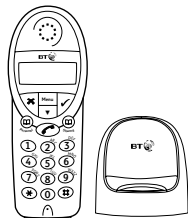

Additional chargers:



Accessories for the handset or charger

Plug mounted,
13 amp mains adaptor.

Item code 005977



Telephone line cord



Batteries



Battery cover



Belt clip



User guide



RTTE

This product is intended for use within the UK for connection to the public telephone network and compatible switchboards.

This equipment complies with the essential requirements for the Radio Equipment and Telecommunications Terminal Equipment Directive 1999/5/EC.

Declaration of Conformance.

Hereby, VTech, declares that this Freestyle 2000 is in compliance with the essential requirements and other relevant provisions of Directive 1999/5/EC.

The Declaration of Conformance for the Freestyle 2000 is published on the web site <http://www.vtecheurope.com>

Visit us at www.bt.com



Offices worldwide

The telecommunications services described in this publication are subject to availability and may be modified from time to time. Services and equipment are provided subject to British Telecommunications plc's respective standard conditions of contract. Nothing in this publication forms any part of any contract.

© British Telecommunications plc 2003.
Registered Office: 81 Newgate Street, London EC1A 7AJ.
Registered in England No. 1800000.
Designed by: The Art & Design Partnership Limited.
Freestyle 2000 Handset & Alarm Clock Radio Charger. Issue 3 (6/03) 3
Printed in China.

