



at&t

User's manual

TL7601

**DECT 6.0 remote dial pad
for use with AT&T models
TL7610/TL7611/
TL7650/TL7651**



Congratulations

on your purchase
of this AT&T product.

Before using this AT&T product, please read the

Important safety information

on pages 26-29 of this manual. Please thoroughly read the user's manual for all the feature operations and troubleshooting information necessary to install and operate your new AT&T product. You can also visit our website at **www.telephones.att.com** or call **1 (800) 222-3111**.

In Canada, dial **1 (866) 288-4268**.

Model #: TL7601

Type: Remote dial pad

Serial #: _____
(found in the battery compartment)

Purchase date: _____

Place of purchase: _____

Save your sales receipt and original packaging in case it is necessary to return your remote dial pad for warranty service.

Parts checklist

Check to make sure the remote dial pad package includes the following items:



User's manual



Dial pad



Charger for dial pad with power adapter installed

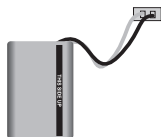

Battery for dial pad

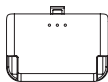

Battery compartment cover

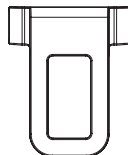

Belt clip for dial pad

User's manual

TL7601

DECT 6.0 remote dial pad

for use with AT&T models

TL7610/TL7611/

TL7650/TL7651



Table of contents

Getting started

Quick reference guide	1
Installation preparation	2
Charger installation	3
Battery installation & charging	4
Remote dial pad registration and de-registration.....	6
Register the remote dial pad to the headset base (with a single headset).....	6
Register the remote dial pad to the headset base (with two headsets).....	7
De-register the remote dial pad	8
Belt clip.....	9

Remote dial pad operation

Remote dial pad settings.....	10
Language	10
Basic operation.....	11
Make a call.....	11
On-hook dialing (predialing).....	11
Answer a call.....	12
Using the remote dial pad.....	12

Using the headset	12
Last number redial.....	12
Options while on calls	14
Call waiting.....	14
Last number redial.....	14
Screen icons & display screen messages.....	15

Troubleshooting

Troubleshooting.....	17
----------------------	----

Maintenance and safety

Maintenance	25
Important safety information.....	26

Appendix

FCC Part 68 and ACTA.....	30
FCC Part 15	33
Limited warranty	35
Technical specifications.....	39

Index

Index.....	40
------------	----

Quick reference guide

Loop

You can string a neck or wrist cord (not provided) through this loop.

LANG/SEL

Press to review and change language options (page 10). Press again to save the setting.

While reviewing redial memory, press to select a phone number (page 12).

CHARGE light

On when the remote dial pad is charging (page 5).

CALL/FLASH

Press to make or answer a call. During a call, press to receive call waiting (page 14).

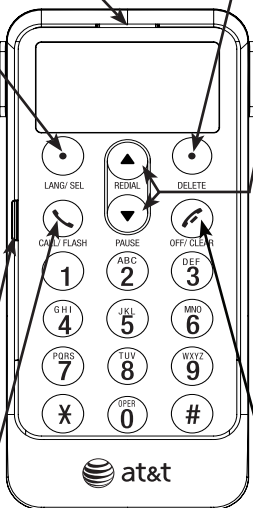

DELETE

While reviewing the redial memory, press to delete an individual entry, or press to clear the redial history (page 13). While predialing, press to delete digits (page 11).

▲up/▼down

When you are not using the dial pad, press ▲ to view the redial memory. Then press ▲ or ▼ to scroll through the redial memory (page 12). While in the LANG feature, press to display the language options. While entering digits, press and hold ▼ PAUSE to insert a dialing pause (page 13).

OFF/CLEAR

During a call, press to hang up. While in menus, press to cancel the operation and exit the menu display. While predialing, press to delete digits (page 11).

For complete instructions on using the headset, please refer to the manual provided with your TL7610/TL7611/TL7650/TL7651 product. If you are unable to find your manual, visit www.telephones.att.com to view or download the manual.

Installation preparation

You must install and charge the battery before using the remote dial pad.



See pages 4-5 for easy instructions.

Your product may be shipped with a protective sticker covering the remote dial pad display - remove it before use.

For customer service or product information, visit our website at **www.telephones.att.com** or call **1 (800) 222-3111**.
In Canada, dial **1 (866) 288-4268**.

Avoid placing the remote dial pad too close to:

- Communication devices such as: television sets, VCRs, or other cordless telephones.
- Excessive heat sources.
- Noise sources such as a window with traffic outside, motors, microwave ovens, refrigerators, or fluorescent lighting.
- Excessive dust sources such as a workshop or garage.
- Excessive moisture.
- Extremely low temperature.
- Mechanical vibration or shock such as on top of the washing machine or work bench.

Charger installation

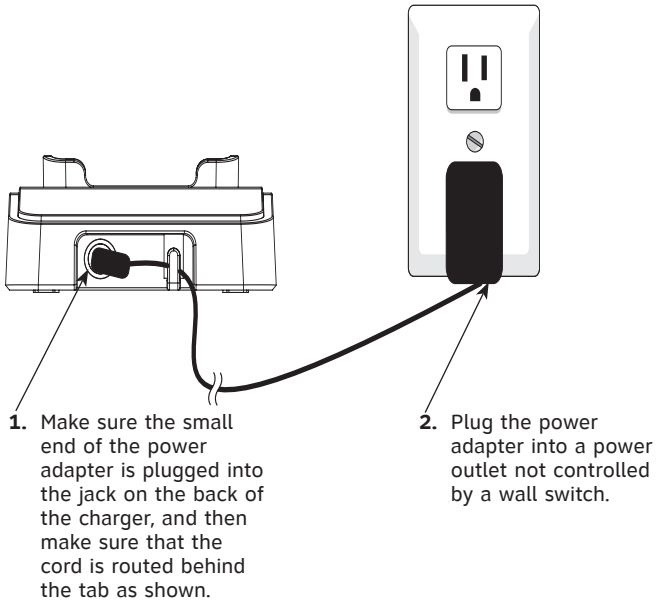

IMPORTANT INFORMATION

1. Use only the power adapter supplied with this product. To order a replacement power adapter, visit our website at **www.telephones.att.com**, or call **1 (800) 222-3111**. In Canada dial **1 (866) 288-4268**.
2. The power adapter is intended to be correctly oriented in a vertical or floor mount position. The prongs are not designed to hold the plug in place if it is plugged into a ceiling, under-the-table or cabinet outlet.

Battery installation & charging

Install the battery as shown below. After installing the battery, place the remote dial pad in the charger. For optimal performance, charge the remote dial pad battery for at least six hours before use.

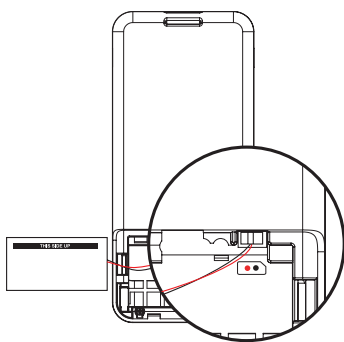

Step 1

Insert the battery plug securely into the jack located inside the remote dial pad battery compartment, matching the color-coded label.

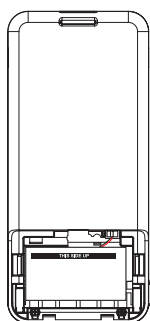

Step 2

Place the battery in the compartment with the label **THIS SIDE UP** facing up as indicated.

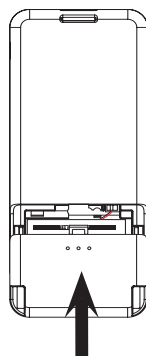

Step 3

Align the cover flat against the battery compartment, then slide it upwards until it clicks into place.

Battery installation & charging

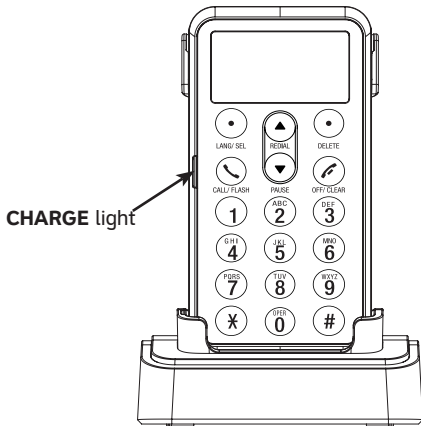





Step 4

Charge the remote dial pad by placing it face up in the charger. The **CHARGE** light is on when the dial pad battery is charging.



NOTE:

1. When the battery is charging, you will see the cycling   . When the battery is fully charged, you will see .
2. If the display on the remote dial pad is blank, try unplugging the power adapter, and firmly plugging it in again.

IMPORTANT INFORMATION

Use only the supplied rechargeable battery or replacement battery (AT&T model BT190545). To obtain your replacement battery, visit our website at www.telephones.att.com, or call **1 (800) 222-3111**. In Canada, dial **1 (866) 288-4268**.

Remote dial pad registration and de-registration

The TL7601 remote dial pad allows you to place phone calls with an AT&T DECT 6.0 cordless headset system. You must register it to the TL7610/TL7611/TL7650/TL7651 headset base before use. The remote dial pad should be charged for a minimum of five minutes before attempting registration to the headset base. You cannot register the dial pad to the headset base before a headset is registered to the headset base.

The remote dial pad does not work with an AT&T DECT 6.0 cordless headset system that is connected to a telephone that is part of a digital business system unless there is an analog adapter on the line. Please contact your IT department, telephone administrator, or your telephone service provider to determine if this remote dial pad is compatible with your telephone system.

Register the remote dial pad to the headset base (with a single headset)

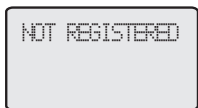

1. The new remote dial pad should be charged for at least five minutes before registering to the headset base. When the remote dial pad is removed from the charger, it shows **NOT REGISTERED** on the screen.

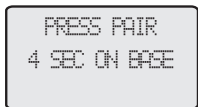

2. Place the unregistered remote dial pad into the charger. If **PRESS PAIR 4 SEC ON BASE** does not appear on the remote dial pad screen after a few seconds, remove the remote dial pad and place it in the charger again.

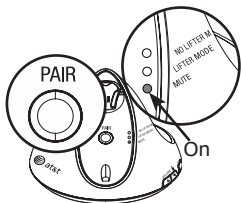

3. On the headset base, press and hold the **PAIR** button for about four seconds

Remote dial pad registration and de-registration

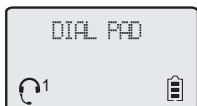
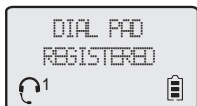
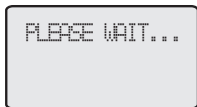

(until the red **MUTE** light on the headset base turns on) and then release the button. The remote dial pad shows **PLEASE WAIT...**, then **DIAL PAD REGISTERED**. It takes about 30 seconds to complete the registration.

4. The **MUTE** light turns off and you see the **DIAL PAD** screen (shown on the left) indicating successful registration.

Register the remote dial pad to the headset base (with two headsets)

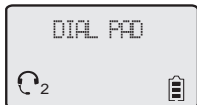

- The dial pad can only be paired with one headset, even if there are two headsets in your system. The dial pad pairs with the most recently registered headset. The display indicates the paired dial pad by showing either C^1 or C^2 .



NOTES:

1. You cannot register a remote dial pad if a system headset is in use.
2. If the registration is not successful, the display shows **NOT REGISTERED**. Reset the remote dial pad by lifting it out of the charger and then placing it back in the charger. Now try the registration process again.
3. If you have one registered headset, the remote dial pad automatically connects to the headset after registering on the headset base.
4. If you have two headsets, and you want the other headset to work with the remote dial pad, you have to de-register all the headsets and the remote dial pad first. Refer to the de-registration information on page 8. Then re-register the headsets and dial pad.
5. Registration time depends on environmental conditions and varies.

Remote dial pad registration and de-registration

De-register the remote dial pad

Please read carefully through all the instructions on this page before beginning the de-registration process.

This de-registration de-registers all the items registered to the headset base, including all headsets and the remote dial pad.

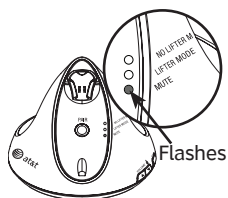

1. Press and hold the **PAIR** button on the headset base until the **MUTE** light starts to flash, then release the **PAIR** button.

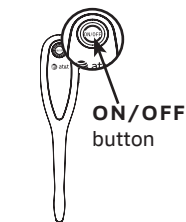

2. Immediately press and release the **PAIR** button again. You must press the **PAIR** button while the **MUTE** light is still flashing. (If the light stops flashing before the dial pad is de-registered, pick up the remote dial pad and place it back into the charger, then start again with step one above.)

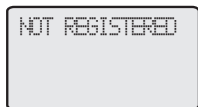
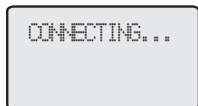

3. If the de-registration was successful, the **MUTE** light on the headset base turns off. The headset(s) **ON/OFF** light flashes twice every five seconds. The dial pad displays **CONNECTING...**, then **NOT REGISTERED**.



NOTE: De-registering the remote dial pad from the headset base also de-registers all the headsets. To use the remote dial pad or the headset again, refer to the registration information on pages 6-7.

Belt clip

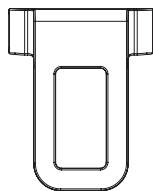

To attach the belt clip:

Snap the belt clip into the retaining tabs on both sides of the dial pad as shown in the figure.

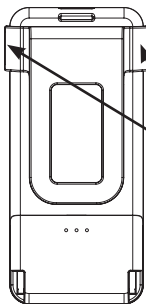

To remove the belt clip:

Gently lift either of the belt clip retaining tabs, shown in the figure, to remove the belt clip from the dial pad.

Remote dial pad settings

Language

You can select the language used for all screen displays.

To select a language:

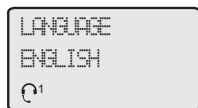

1. Press **LANG/SEL** when in idle mode.
2. Use ▲ / ▼ to scroll to **ENGLISH, FRANCAIS** or **ESPANOL**.
3. Press **LANG/SEL** again to save your preference and return to the idle mode.

Basic operation

Make a call

Elapsed
time

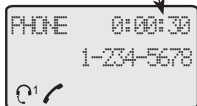

To make a call:

- Press **ON/OFF** on the headset to turn on the headset, then enter the telephone number on the dial pad, and press **CALL/FLASH** on the remote dial pad.

-OR-

- Press **ON/OFF** on the headset to turn on the headset, then press **CALL/FLASH** on the remote dial pad, and enter the telephone number on the dial pad.

To end a call:

- Press **OFF/CLEAR** on the remote dial pad.

-OR-

- Press **ON/OFF** on the headset.

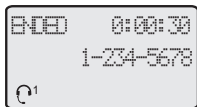

NOTE: The screen displays the elapsed time of your telephone conversation (in hours, minutes and seconds).

On-hook dialing (predialing)

1. Enter the telephone number. Press **OFF/CLEAR** or **DELETE** to delete any unwanted digits.
2. Press **CALL/FLASH** to dial the displayed number.



NOTES:

1. If it cannot complete the call, the dial pad screen displays **UNABLE TO CALL TRY AGAIN**.
2. If you press **CALL/FLASH** before entering numbers, the dial pad screen displays **ENTER TEL# THEN PRESS CALL**.

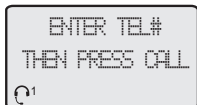
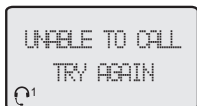

Basic operation

Answer a call

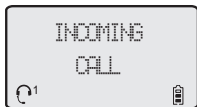

Using the remote dial pad:

- Press  **CALL/FLASH**

-OR-

- Press any key (**0-9**, * or #) on the remote dial pad.

To end a call:

- Press  **OFF/CLEAR**.

Using the headset:

- Press **ON/OFF** on the headset.

To end a call:



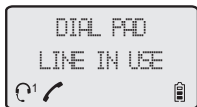

- Press **ON/OFF** on the headset.



NOTE: When another headset or telephone is using the telephone line, **LINE IN USE** appears on the screen. Press  **CALL/Flash** during a call to see the elapsed call time.

Last number redial

To view the five most recently dialed numbers:

- Press one of the  /  to enter the redial number display mode.
- Press  /  repeatedly to view the last five recently called numbers (up to 30 digits).

Press **LANG/SEL** to select a phone number, or press  **OFF/CLEAR** to exit.

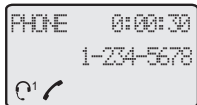

To redial a number:

- Press  **CALL/FLASH** to dial the displayed number.

Basic operation

Last number redial (continued)

To remove a number:

- While the desired number is displayed, press **DELETE** to delete the displayed number from the redial memory.

To edit a number:

- While the desired number is displayed, press **LANG/SEL** to enter the editing mode, then press **OFF/CLEAR** or **DELETE** to make corrections.
- While entering digits, press **▼ PAUSE** to insert a dialing pause.

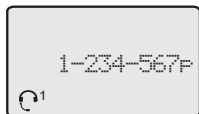

Options while on calls

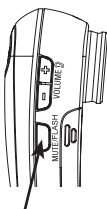
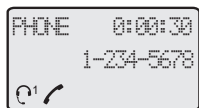

MUTE/FLASH button



NOTES:

- Pressing **CALL/FLASH** to access services from your local telephone service provider will not affect the elapsed time, which will continue to record the total talk time.
- You cannot press **OFF/CLEAR** to exit call waiting without ending the call.

Call waiting

If you subscribe to call waiting service with your local telephone service provider, you will hear a beep in the headset if there is an incoming call while you are already on a call. Press **CALL/FLASH** on the remote dial pad or press and hold the **MUTE/FLASH** key on the headset to put your current call on hold and take the new call. Press **CALL/FLASH** on the remote dial pad or press and hold the **MUTE/FLASH** key on the headset at any time to switch back and forth between calls.

To end call waiting call, press **ON/OFF** on the headset.

When you connect the headset with a corded phone using **LIFTER MODE**, press the flash button on the corded phone to switch back and forth between calls.

Last number redial

- While on a call, pressing **▲** or **▼** on the remote dial pad only displays the number last dialed.
- The displayed number is dialed if you press **CALL/FLASH**.

Press **OFF/CLEAR** on the dial pad or press **ON/OFF** on the headset to exit the call.

Screen icons & display screen messages



Screen icons



The remote dial pad works with headset 1.



The remote dial pad works with headset 2.



The telephone line is in use.



Battery charging (animated display).

Display screen messages

CHARGING

The remote dial pad with a low battery has been placed in the remote dial pad charger.

CONNECTING ...

The remote dial pad is registering to the headset base, or has lost communication with the headset base.

DIAL PAD

The remote dial pad is in idle mode.

DIAL PAD
REGISTERED

The dial pad has been successfully registered to the headset base.

ENDED

You have just ended a call.

Screen icons & display screen messages



Display screen messages

ENTER TEL# THEN PRESS CALL	Enter the telephone number, then press  CALL/FLASH .
INCOMING CALL	There is a call coming in.
LANGUAGE	You can select a language for the dial pad display.
LINE IN USE	An extension phone or one of the headsets is in use.
NOT REGISTERED	The remote dial pad has not yet been registered to the headset base.
PHONE	The remote dial pad is in use.
PLACE IN CHARGER	The battery is very low. The dial pad should be placed in the remote dial pad charger for recharging.
PRESS PAIR 4 SEC ON BASE	Press the PAIR button on the headset base for four seconds to register the dial pad.
REDIAL	The dial pad is in the redial memory.
UNABLE TO CALL TRY AGAIN	An attempt to make a call has failed.

Troubleshooting

If you have difficulty with your remote dial pad, please try the suggestions below. For Customer Service, visit our website at **www.telephones.att.com**, or call **1 (800) 222-3111**. In Canada, dial **1 (866) 288-4268**.

My remote dial pad doesn't work at all.

- Make sure the battery is correctly installed with the plug securely connected.
- Make sure the power cord is securely plugged into the remote dial pad charger, and the charger adapter is plugged into a working electrical power outlet not controlled by a wall switch.
- Make sure the remote dial pad is registered to a headset base (AT&T models TL7610/TL7611/TL7650/TL7651 only).
- The remote dial pad does not work with any AT&T DECT 6.0 cordless headset system that is connected to a telephone that is part of a digital business system unless there is an analog terminal adapter (ATA) on the line. Please contact your IT department, telephone administrator, or your telephone service provider to determine if this remote dial pad is compatible with your telephone system.
- Make sure the telephone line cord and other necessary cables are firmly connected to the headset base.
- Make sure the remote dial pad is fully charged. For optimal daily performance, return the remote dial pad to its charger when not in use.

Troubleshooting

- Reset the headset base. Unplug the electrical power of the headset base. Wait for approximately 15 seconds, then plug it back in. Follow the directions for remote dial pad registration.
 - You may need a new dial pad battery. Please refer to **Battery installation & charging**, pages 4-5, in this user's manual.
-

I cannot dial out.

- First try all the suggestions on the previous page.
- Make sure you have a dial tone in the headset before dialing. The remote dial pad may take a second or two to find the headset base and produce a dial tone. This is normal. Wait an extra second before dialing.
- Check the **LIFTER MODE** selected on the headset base. Please refer to the manual provided with your headset base.
- If you have installed a handset lifter, make sure the installation of the lifter is correct. Please refer to the manual provided with you remote handset lifter.
- Eliminate any background noise. Noise from a television, radio or other appliances may cause the remote dial pad to not dial out properly. If you cannot eliminate the background noise, try dialing from another room or office with less background noise.

Troubleshooting

- If the other phones in your home or office are having the same problem, the problem is in your wiring or local service. Contact your local telephone company (charges may apply).

My remote dial pad isn't performing normally.

- Make sure the power cord is securely plugged into the remote dial pad charger, and the remote dial pad is in the charger. Plug the charger power adapter into a different working electrical outlet not controlled by a wall switch.
- Move the remote dial pad closer to the headset base. You might have moved out of range.
- Reset the headset base. Unplug the unit's electrical power. Wait for 15 seconds then plug it back in. Follow the procedures on pages 6-7 to register the remote dial pad again.
- Other electronic products can cause interference to your cordless phone. Try installing your phone as far away from these types of electronic devices as possible: television sets, VCRs, or other cordless telephones.

CONNECTING...
displays on my remote dial pad.

- Ensure that the headset base is powered up.
- Move the remote dial pad closer to the headset base. You might have moved out of range.

Troubleshooting

- Follow the directions for dial pad registration on pages 6-7. Wait for several seconds until the screen message changes to **DIAL PAD**, confirming that registration was successful.
- Disconnect and re-install the remote dial pad battery, then perform the dial pad registration procedure again.
- Reset the headset base. Unplug the unit's electrical power. Wait for 15 seconds and plug it back in. The remote dial pad needs to be registered again.
- Other electronic products can cause interference to your cordless phone. Try installing your phone as far away from these types of electronic devices as possible: television sets, VCRs, or other cordless telephones.

The battery does not hold a charge.

- If the remote dial pad is in its charger and the **CHARGE** light does not come on, refer to **The CHARGE light is off** on page 22 in this **Troubleshooting** section.
- Ensure that the battery is correctly installed with the plug securely connected.
- Charge the battery in the remote dial pad for at least six hours. For optimum daily performance, return the remote dial pad to its charger when not in use.
- You may need a new battery. Please refer to

Troubleshooting

the **Battery installation & charging** section (pages 4-5) of this user's manual.

- Your remote dial pad might be malfunctioning. Please refer to the **Limited warranty** section (pages 35-38) of this user's manual for further instruction.

My remote dial pad does not react when I receive a call.

- Make sure that the remote dial pad is registered to the headset base.
- The remote dial pad may be too far from the headset base. Move it closer to the headset base within the operating range.
- The layout of your home or office might be limiting the operating range. Try moving the headset base to another location, preferably on an upper floor.
- Charge the battery in the remote dial pad for at least six hours. For optimum daily performance, return the remote dial pad to its charger when not in use.
- Other electronic products can cause interference to your cordless phone. Try installing your phone as far away from these types of electronic devices as possible: television sets, VCRs, or other cordless telephones.
- Disconnect, and then re-install the battery. Place the remote dial pad in the charger. Wait for the remote dial pad to re-establish its connection with the headset base. Allow up to one minute for this to take place.

Troubleshooting

The **CHARGE** light is off.

- Make sure the power adapter is plugged in correctly and securely to a working electrical power outlet not controlled by a wall switch.
 - Ensure that the battery is correctly installed with the plug securely connected.
 - Clean the remote dial pad charging contacts each month using a pencil eraser or cloth.
 - Your phone might be malfunctioning. Please refer to the **Limited warranty** section (pages 35-38) of this user's manual for further instruction.
-

My call waiting isn't working.

- Call waiting is a subscription service. You must subscribe to this service from your local telephone company for this feature to work on your telephone.
 - Your caller must be calling from an area that supports call waiting service.
 - Both you and your caller's telephone companies must use compatible equipment.
-

I cannot switch to the call waiting call.

- Press and hold **MUTE/FLASH** at any time to switch back and forth between calls (see page 14).
- If the headset is connected to a corded phone using **LIFTER MODE**, the flash function on the headset does not work. To switch to the call waiting call, press the flash button on the corded phone.

Troubleshooting

I cannot register my dial pad to my cordless phone.

- The TL7601 dial pad can only be registered to the TL7610/7611 headset base.

I cannot register my dial pad to the TL7600 accessory headset charger.

- The 7601 dial pad can only be registered to the TL7610/7611 headset base.

I cannot register my dial pad to the TL7610/7611 headset base.

The dial pad can only be registered to the TL7610/7611 headset base if there is a headset registered to the base first.

If you have registered the headset to a AT&T DECT 6.0 cordless telephone, do the following:

- De-register the headset from the telephone base (see instructions in the telephone user's manual).
- Register the headset to the headset base (see page 33 of the TL7610/7611 user's manual).
- Register the dial pad to the headset base (see page 6).

Common cure for electronic equipment.

If the unit does not seem to be responding normally, try putting the remote dial pad in its charger. If it does not seem to respond, do the following (in the order listed):

Troubleshooting

- Disconnect the power to the headset base.
- Disconnect the remote dial pad battery.
- Wait a few minutes.
- Connect power to the headset base.
- Re-install the battery, and place the remote dial pad into the dial pad charger.
- Wait for the remote dial pad to re-establish its connection with the headset base. Allow up to one minute for this to take place.

Maintenance

Taking care of your remote dial pad

- Your remote dial pad contains sophisticated electronic parts, so it must be treated with care.
- Avoid rough treatment.
- Put the remote dial pad down gently. Save the original packing materials to protect your remote dial pad if you ever need to return it.

Avoid water

- Your remote dial pad can be damaged if it gets wet. Do not use the dial pad outdoors in the rain, or handle it with wet hands. Do not install the remote dial pad near a sink, bathtub or shower.

Electrical storms

- Electrical storms can sometimes cause power surges harmful to electronic equipment. For your own safety, take caution when using electric appliances during storms.

Cleaning your remote dial pad

- Your remote dial pad has a durable plastic casing that should retain its luster for many years. Clean it only with a soft cloth slightly dampened with water or a mild soap.
- Do not use excess water or cleaning solvents of any kind.

Remember that electrical appliances can cause serious injury if used when you are wet or standing in water. If the remote dial pad charger should fall into water, DO NOT RETRIEVE IT UNTIL YOU UNPLUG THE POWER CORD FROM THE WALL. Then pull the unit out by the unplugged cord.

Important safety information



This symbol is to alert you to important operating or servicing instructions that may appear in this user's manual. Always follow basic safety precautions when using this product to reduce the risk of injury, fire, or electric shock.

Safety information

- **Read and understand all instructions in the user's manual. Observe all markings on the product.**
- **Avoid using a remote dial pad during a thunderstorm.** There may be a slight chance of electric shock from lightning.
- **Do not use a remote dial pad in the vicinity of a gas leak.** If you suspect a gas leak, report it immediately, but use a remote dial pad away from the area where the gas is leaking, and make sure the remote dial pad charger is also away from the area.
- **Do not use this product near water, or when you are wet.** For example, do not use it in a wet basement or shower, or next to a swimming pool, bathtub, kitchen sink, or laundry tub. Do not use liquids or aerosol sprays for cleaning. If the product comes in contact with any liquids, unplug any line or power cord immediately. Do not plug the product back in until it has dried thoroughly.
- **Install this product in a protected location** where no one can trip over any line or power cords. Protect cords from damage or abrasion.
- **If this product does not operate normally, see the Troubleshooting section on pages 17-24 of this user's manual.** If you cannot solve the problem, or if the product is damaged, refer to the **Limited warranty** on pages 35-38. Do not open this product except as may be directed in your user's manual. Opening the product or reassembling it incorrectly may expose you to hazardous voltage or other risks.

Important safety information

- **Replace batteries only as described in your user's manual.** Do not burn or puncture batteries — they contain caustic chemicals.
- **This power adapter is intended to be correctly oriented in a vertical or floor mount position.** The prongs are not designed to hold the plug in place if it is plugged into a ceiling or an under-the-table/cabinet outlet.



Caution: Use only the power adapter provided with this product. To obtain a replacement, visit our website at

www.telephones.att.com or call **1 (800) 222-3111**.

In Canada, dial **1 (866) 288-4268**.

Especially about cordless telephones:

- **Privacy:** The same features that make a cordless telephone convenient create some limitations. Telephone calls are transmitted between the telephone base and the handset by radio waves, so there is a possibility that your cordless telephone conversations could be intercepted by radio receiving equipment within range of the cordless handset. **For this reason, you should not think of cordless telephone conversations as being as private as those on corded telephones.**
- **Electrical power:** The telephone base of this cordless telephone must be connected to a working electrical outlet that is not controlled by a wall switch. **Calls cannot be made from the handset if the telephone base is unplugged or switched off, or if the electrical power is interrupted.**
- **Potential TV interference:** Some cordless telephones operate at frequencies that may cause interference to TVs and VCRs. To minimize or prevent such interference, do not place the telephone base of the cordless telephone near or on top of a TV or VCR. If interference is experienced, moving the cordless telephone farther away from the TV or VCR will often reduce or eliminate the interference.

Important safety information

or eliminate the interference.

- **Rechargeable batteries:** This product contains nickel-cadmium, nickel-metal hydride or lithium-ion rechargeable batteries. Exercise care in handling batteries in order to not create a short circuit with conductive material such as rings, bracelets, and keys. The battery or conductor may overheat and cause harm. Observe proper polarity between the battery and the battery charger.
- **Lithium-ion rechargeable batteries:** Dispose of these batteries in a safe manner. Do not burn or puncture. Like other batteries of this type, if burned or punctured, they could release caustic material that could cause injury.



The RBRC™ Seal means that the manufacturer is voluntarily participating in an industry program to collect and recycle lithium-ion rechargeable batteries when taken out of service within the United States. These batteries may be taken to a participating local retailer of replacement batteries or recycling center. Or you may call 1-800-8-BATTERY for locations accepting spent Li-ion batteries.

CAUTION

- Use only the batteries provided or their equivalent.
- Change this product's batteries only in accordance with the instructions and limitations specified in this manual.
- As with any batteries, do not allow conductive materials such as rings, bracelets, or keys to come in contact with the metallic parts of the battery. The battery or conductor may overheat and cause harm.
- Do not open or damage the batteries. Released electrolyte is corrosive and may cause injury to the eyes or skin. The electrolyte may be toxic if swallowed.
- Do not dispose of the batteries in a fire. Check with local waste management codes for special disposal instructions.

Important safety information

- To prevent fire or shock hazard, do not expose this product to water or any type of moisture.
- Observe proper polarity orientation between the battery and the metallic contacts.
- Do not disassemble your telephone. There are no user-serviceable parts inside. Refer to qualified service personnel for servicing.

Precautions for users of implanted cardiac pacemakers

Cardiac pacemakers (applies only to digital cordless telephones): Wireless Technology Research, LLC (WTR), an independent research entity, led a multidisciplinary evaluation of the interference between portable cordless telephones and implanted cardiac pacemakers. Supported by the U.S. Food and Drug Administration, WTR recommends to physicians that:

PACEMAKER PATIENTS

- Should keep cordless telephone at least six inches from the pacemaker.
- Should NOT place cordless telephones directly over the pacemaker, such as in a breast pocket, when it is turned ON.
- Should use the cordless telephone at the ear opposite the pacemaker.

WTR's evaluation did not identify any risk to bystanders with pacemakers from other persons using cordless telephones.

SAVE THESE INSTRUCTIONS

FCC Part 68 and ACTA

This equipment complies with Part 68 of the FCC rules and with technical requirements adopted by the Administrative Council for Terminal Attachments (ACTA). The label on the back or bottom of this equipment contains, among other things, a product identifier in the format US:AAAEQ##TXXXX. This identifier must be provided to your local telephone company upon request.

The plug and jack used to connect this equipment to premises wiring and the telephone network must comply with applicable Part 68 rules and technical requirements adopted by ACTA. A compliant telephone cord and modular plug is provided with this product. It is designed to be connected to a compatible modular jack that is also compliant. An RJ11 jack should normally be used for connecting to a single line and an RJ14 jack for two lines. See Installation Instructions in the user's manual.

The Ringer Equivalence Number (REN) is used to determine how many devices you may connect to your telephone line and still have them ring when you are called. The REN for this product is encoded as the 6th and 7th characters following the US: in the product identifier (e.g., if ## is 03, the REN is 0.3). In most, but not all areas, the sum of all RENs should be five (5.0) or less. For more information, please contact your local telephone company.

This equipment may not be used with Party Lines. If you have specially wired alarm dialing equipment connected to your telephone line, ensure the connection of this equipment does not disable your alarm equipment. If you have questions about what will disable alarm equipment, consult your telephone company or a qualified installer.

If this equipment is malfunctioning, it must be unplugged from the modular jack until the problem has been corrected. Repairs to this telephone equipment can only be made by the manufacturer or its authorized agents. For repair procedures, follow the instructions outlined under the Limited Warranty.

FCC Part 68 and ACTA

If this equipment is causing harm to the telephone network, the telephone company may temporarily discontinue your telephone service. The telephone company is required to notify you before interrupting service. If advance notice is not practical, you will be notified as soon as possible. You will be given the opportunity to correct the problem and the telephone company is required to inform you of your right to file a complaint with the FCC. Your telephone company may make changes in its facilities, equipment, operation, or procedures that could affect the proper functioning of this product. The telephone company is required to notify you if such changes are planned.

If this product is equipped with a corded or cordless handset, it is hearing aid compatible.

If this product has memory dialing locations, you may choose to store emergency telephone numbers (e.g., police, fire, medical) in these locations. If you do store or test emergency numbers, please:

Remain on the line and briefly explain the reason for the call before hanging up.

Perform such activities in off-peak hours, such as early morning or late evening.

FCC Part 68 and ACTA

Industry Canada

Operation is subject to the following two conditions: (1) this device may not cause harmful interference, and (2) this device must accept any interference, including interference that may cause undesired operation.

The term "IC:" before the certification/registration number only signifies that the Industry Canada technical specifications were met.

The Ringer Equivalence Number (REN) for this terminal equipment is 0.1. The REN is an indication of the maximum number of devices allowed to be connected to a telephone interface. The termination on an interface may consist of any combination of devices subject only to the requirement that the sum of the RENs of all the devices does not exceed five.

This product meets the applicable Industry Canada technical specifications.

FCC Part 15

This equipment has been tested and found to comply with the requirements for a Class B digital device under Part 15 of the Federal Communications Commission (FCC) rules.

These requirements are intended to provide reasonable protection against harmful interference in a residential installation. This equipment generates, uses and can radiate radio frequency energy and, if not installed and used in accordance with the instructions, may cause harmful interference to radio communications. However, there is no guarantee that interference will not occur in a particular installation.

If this equipment does cause harmful interference to radio or television reception, which can be determined by turning the equipment off and on, the user is encouraged to try to correct the interference by one or more of the following measures:

- Reorient or relocate the receiving antenna.
- Increase the separation between the equipment and receiver.
- Connect the equipment into an outlet on a circuit different from that to which the receiver is connected.
- Consult the dealer or an experienced radio/TV technician for help.

Changes or modifications to this equipment not expressly approved by the party responsible for compliance could void the user's authority to operate the equipment.

This device complies with Part 15 of the FCC Rules. Operation is subject to the following two conditions: (1) this device may not cause harmful interference, and (2) this device must accept any interference received, including interference that may cause undesired operation. Privacy of communications may not be ensured when using this device.

FCC Part 15

To ensure safety of users, the FCC has established criteria for the amount of radio frequency energy that can be safely absorbed by a user or bystander according to the intended usage of the product. This product has been tested and found to comply with the FCC criteria. The headset may be safely held against the ear of the user. The headset base shall be installed and used such that parts of the user's body other than the hands are maintained at a distance of approximately 20 cm (8 inches) or more. If you choose to use a clipping device, please make sure to only use the supplied AT&T belt clip.

This Class B digital apparatus complies with Canadian ICES-003.

Limited warranty

The AT&T brand is used under license - any repair, replacement or warranty service, and all questions about this product should be directed to: In the United States of America, visit **www.telephones.att.com** or call **1 (800) 222-3111**. In Canada, call **1 (866) 288-4268**.

1. What does this limited warranty cover?

The manufacturer of this AT&T-branded product warrants to the holder of a valid proof of purchase (“CONSUMER” or “you”) that the product and all accessories provided in the sales package (“PRODUCT”) are free from defects in material and workmanship, pursuant to the following terms and conditions, when installed and used normally and in accordance with the PRODUCT operating instructions. This limited warranty extends only to the CONSUMER for products purchased and used in the United States of America and Canada.

2. What will be done if the PRODUCT is not free from defects in materials and workmanship during the limited warranty period (“materially defective PRODUCT”)?

During the limited warranty period, the manufacturer’s authorized service representative will repair or replace at the manufacturer’s option, without charge, a materially defective PRODUCT. If the manufacturer repairs the PRODUCT, they may use new or refurbished replacement parts. If the manufacturer chooses to replace the PRODUCT, they may replace it with a new or refurbished PRODUCT of the same or similar design. The manufacturer will retain defective parts, modules, or equipment. Repair or replacement of the PRODUCT, at the manufacturer’s option, is your exclusive remedy. The manufacturer will return repaired or replacement products to you in working condition. You should expect the repair or replacement to take approximately 30 days.

Limited warranty

3. How long is the limited warranty period?

The limited warranty period for the PRODUCT extends for ONE (1) YEAR from the date of purchase. If the manufacturer repairs or replaces a materially defective PRODUCT under the terms of this limited warranty, this limited warranty also applies to repaired or replacement PRODUCT for a period of either (a) 90 days from the date the repaired or replacement PRODUCT is shipped to you or (b) the time remaining on the original one-year limited warranty; whichever is longer.

4. What is not covered by this limited warranty?

This limited warranty does not cover:

- PRODUCT that has been subjected to misuse, accident, shipping or other physical damage, improper installation, abnormal operation or handling, neglect, inundation, fire, water, or other liquid intrusion; or
- PRODUCT that has been damaged due to repair, alteration, or modification by anyone other than an authorized service representative of the manufacturer; or
- PRODUCT to the extent that the problem experienced is caused by signal conditions, network reliability or cable or antenna systems; or
- PRODUCT to the extent that the problem is caused by use with non-AT&T accessories; or
- PRODUCT whose warranty/quality stickers, PRODUCT serial number plates or electronic serial numbers have been removed, altered or rendered illegible; or
- PRODUCT purchased, used, serviced, or shipped for repair from outside the United States of America or Canada, or used for commercial or institutional purposes (including but not limited to products used for rental purposes); or

Limited warranty

- PRODUCT returned without valid proof of purchase (see item 6 below); -or-
- Charges for installation or setup, adjustment of customer controls, and installation or repair of systems outside the unit.

5. How do you get warranty service?

To obtain warranty service in the United States of America, visit **www.telephones.att.com** or call **1 (800) 222-3111**. In Canada, call **1 (866) 288-4268**. NOTE: Before calling for service, please review the user's manual; a check of the PRODUCT controls and features may save you a service call.

Except as provided by applicable law, you assume the risk of loss or damage during transit and transportation and are responsible for delivery or handling charges incurred in the transport of the PRODUCT(s) to the service location. The manufacturer will return repaired or replaced PRODUCT under this limited warranty to you. Transportation, delivery or handling charges are prepaid. The manufacturer assumes no risk for damage or loss of the PRODUCT in transit. If the PRODUCT failure is not covered by this limited warranty, or proof of purchase does not meet the terms of this limited warranty, the manufacturer will notify you and will request that you authorize the cost of repair prior to any further repair activity. You must pay for the cost of repair and return shipping costs for the repair of products that are not covered by this limited warranty.

6. What must you return with the PRODUCT to get warranty service? You must:

- a. Return the entire original package and contents including the PRODUCT to the service location along with a description of the malfunction or difficulty; and
- b. Include "valid proof of purchase" (sales receipt) identifying the PRODUCT purchased (PRODUCT model) and the date of purchase or receipt; and
- c. Provide your name, complete and correct mailing address, and telephone number.

Limited warranty

7. Other limitations

This warranty is the complete and exclusive agreement between you and the manufacturer of this AT&T branded PRODUCT. It supersedes all other written or oral communications related to this PRODUCT. The manufacturer provides no other warranties for this PRODUCT. The warranty exclusively describes all of the manufacturer's responsibilities regarding the PRODUCT. There are no other express warranties. No one is authorized to make modifications to this limited warranty and you should not rely on any such modification.

State/Provincial Law rights: This warranty gives you specific legal rights, and you may also have other rights that vary from state to state or province to province.

Limitations: Implied warranties, including those of fitness for a particular purpose and merchantability (an unwritten warranty that the PRODUCT is fit for ordinary use) are limited to one year from date of purchase. Some states/provinces do not allow limitations on how long an implied warranty lasts, so the above limitation may not apply to you. In no event shall the manufacturer be liable for any indirect, special, incidental, consequential, or similar damages (including, but not limited to lost profits or revenue, inability to use the PRODUCT or other associated equipment, the cost of substitute equipment, and claims by third parties) resulting from the use of this PRODUCT. Some states/provinces do not allow the exclusion or limitation of incidental or consequential damages, so the above limitation or exclusion may not apply to you.

Please retain your original sales receipt as proof of purchase.

Technical specifications

RF frequency band	1921.536 MHz — 1928.448 MHz
Channels	5
Operating temperature	32°F — 122°F 0°C — 50°C
Dial pad charger voltage (AC voltage, 60Hz)	96 — 127 Vrms
Dial pad voltage	3.2 — 4.2 VDC
Dial pad charger voltage (AC adapter output)	6VDC @200mA
Replacement battery	3.7V 170mAH

Dial pad operating range

This dial pad operates within the maximum power allowed by the Federal Communications Commission (FCC). Even so, this dial pad and headset base can communicate over only a certain distance — which can vary with the locations of the headset base and dial pad, the weather, and the construction of your home or office.

Index

A

AC adapter, 3, 39
Answer calls, 12

B

Basic operation, 11-13
Battery charging, 5, 15
Battery installation, 4, 5
Belt clip, 9

C

Call waiting, 14, 22
CHARGE light, 1, 5, 22

D

Delete digits, 1, 11, 13
Delete redial memory, 13
De-registration, 8
Dial pad operating range, 39
Display screen messages, 15

E

Elapsed time, 11, 14
Ending calls, 11, 12

F

Flash, 14

H

Headset, 6-8, 11, 12, 14-23

I

Important safety instructions, 26-29

L

Language, 1, 10, 16
Last number redial, 12-14
Limited warranty, 35-38

M

Maintenance, 25
Making calls, 11
Mute, 7, 8, 14

O

On-hook dialing, 11

P

Predialing, 11

Q

Quick reference guide, 1

R

Rechargeable battery, 5, 28
Redial, 12-14
Remote dial pad
 de-registration, 8
 registration, 6-7
 settings, 10

S

Screen icons, 15

T

Technical specifications, 39
Troubleshooting, 17-24



www.telephones.att.com