

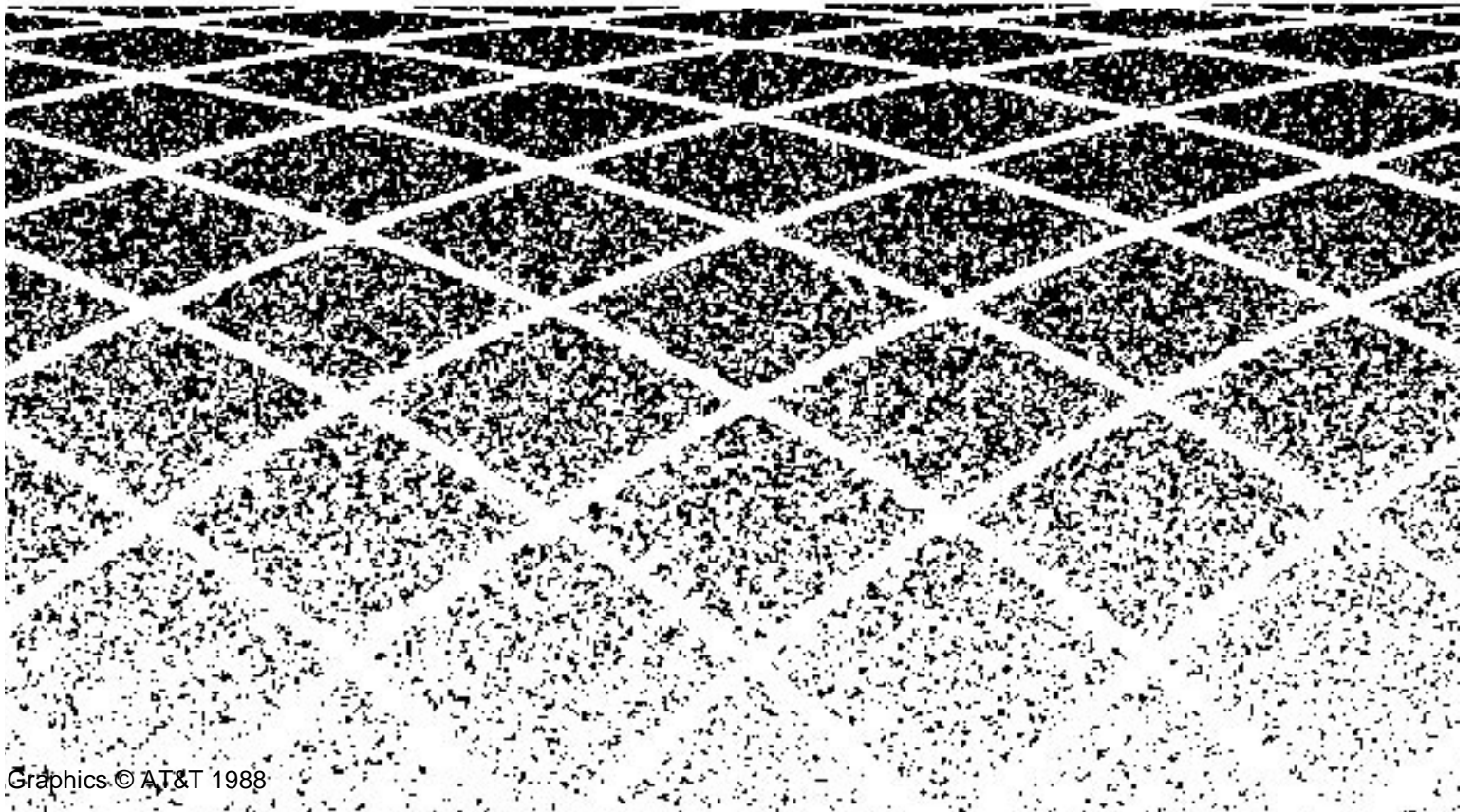

585-310-216
Issue 2
December, 1995

INTUITY™ Integration with NEC® NEAX™ 2400 Switch



Contents

Table of Contents	iii
--------------------------	-----

About This Document	xi
■ Intended Audiences	xii
■ Prerequisite Skills or Knowledge	xii
■ Document Organization	xii
■ How to Use this Document	xiv
■ Conventions Used	xiv
■ Trademarks and Service Marks	xvi
■ Related Resources	xvii
■ How to Make Comments About This Book	xviii

1	Introduction and Requirements for Integration	1-1
	■ Safety Considerations	1-3
	■ Factory Assembled Systems	1-3
	■ Determining the Placement of the SID	1-4
	■ System Configuration	1-5
	Intuity System Required Hardware	1-7
	Switch Integration Device Required Hardware	1-8
	NEC NEAX 2400 MCI Hardware	1-9

2	Switch Integration Device Basics	2-1
	■ The Switch Integration Device Hardware	2-2
	Front Panel	2-2
	Rear Panel	2-2
	■ The Switch Integration Device Software	2-4
	Menu Forms	2-4
	Edit Forms	2-5
	Single Item Edit Forms	2-6
	Two Item Edit Forms	2-6

Contents

Scroll Item Edit Forms	2-6
Edit Form Keys	2-7
Edit Form Help Functions	2-8
Action Forms	2-8

3	Switch Integration Planning	3-1
	■ Determining the Number of Voice Mail Ports	3-2
	■ Setting the Message Desk Number	3-2
	■ Setting the Calling Party Identification Pad String	3-3
	■ Setting the Message Waiting Indicator Pad String	3-3
	■ Setting the Message Waiting Indicator Feature	3-3
	■ Determining the Message Center Interface Baud Rate	3-3
	■ Determining the SMDI Baud Rate	3-4
	■ Determining the Extension/Logical Terminal Number Plan	3-4

4	Hardware Installation	4-1
	■ Connect an Analog Line to the Modem	4-2
	■ Connect the MCI Line to the Switch	4-3
	■ Connect the MCI Cable to the A25B Cable	4-7
	■ Connect the Null Cable and the Y-Cable to the SID	4-8
	■ Connect the SID to the INTUITY System	4-9
	■ Connect the SID Power Cord	4-9

5	Installing SID Software on the INTUITY System	5-1
	■ Requirements	5-1
	■ Stop the Voice System	5-2
	■ Load the SID Software	5-3
	■ Start the Voice System	5-8
	■ Turn on Transfer Feature	5-8

Contents

6 Administering the INTUITY System for the NEAX Integration 6-1

- Administering the Switch Link Administration Screen 6-2
- Stopping and Restarting the Voice System 6-6
- Administering the System Translation Screen 6-7

7 NEAX 2400 Switch Administration 7-1

- Administer Analog Voice Mail Ports 7-2
- Assign Voice Mail Extensions to a UCD Group 7-6
 - Setting Up a UCD Overflow Group 7-8
- Configuring the Message Center Interface Link 7-10
 - Administer the Message Waiting Lamp 7-10
 - Assign a Port for the Message Center Interface Link 7-13
 - Define the Port as a Terminal 7-15
 - Assign the MCI Link to a UCD Group 7-16

8 Switch Integration Device Administration 8-1

- Administer the Basic Parameters 8-2
- Assign Extensions and LTNs 8-4
 - Using AutoFill 8-5
- Saving and Starting the Configuration 8-7
- Administer Serial Data Links 8-8
- Changing System Parameters 8-11
 - Setting the Date and Time 8-11
 - Adjusting the LCD Contrast 8-12
- Special Processing for Message Waiting Lamps 8-13
- Setting a Security Level 8-14

Contents

9	Acceptance Tests	9-1
	■ Administer the Test Subscribers	9-2
	Task 1: Forward Calls for Ring-No-Answer	9-2
	Task 2: Forward Calls for Busy Conditions	9-3
	Task 3: Forward Subscribers for All Calls	9-4

10	Cut-to-Service	10-1
	■ Administer the Subscriber Telephones	10-2
	Task 1: Forward Subscribers for Ring-No-Answer	10-2
	Task 2: Forward Calls for Busy Conditions	10-3
	Task 3: Forward Subscribers for All Calls	10-4

A	Troubleshooting and Error Logs	A-1
	■ Switch Integration Device Problems	A-2
	■ Error Logs	A-5
	■ Clearing Your Configuration	A-9

B	Using Views During Integration	B-1
	■ SMDI Monitor Mode	B-2
	■ Using MCI Monitor Mode	B-4
	■ Using Statistics Mode	B-4
	■ Using Metrics Mode	B-5
	■ Clearing Statistical Information	B-5

C	Switch Administration for INTUITY Lodging	C-1
	■ Introduction	C-1
	■ Hunt Group Administration	C-1
	■ Message Retrieval Administration	C-2

Contents

Message Retrieval in Lodging Systems without AUDIX	C-2
Message Retrieval in Systems Shared with AUDIX	C-2
Retrieval from the AUDIX Application	C-2
Retrieval from the Lodging Application	C-2
Alternate Message Retrieval Method	C-2
■ Voice Mail Administration	C-3
■ Call Coverage Path	C-4
■ Do-Not-Disturb	C-5
■ Cut-to-Service	C-5
Gradual Cut-to-Service	C-5
One-Step Cut-to-Service	C-6
■ Summary	C-6

ABB	Abbreviations	ABB-1
------------	----------------------	-------

GL	Glossary	GL-1
-----------	-----------------	------

IN	Index	IN-1
-----------	--------------	------

Contents

About This Document

INTUITY™ Integration with NEC® NEAX™ 2400 Switch contains installation and administration instructions for integrating a NEAX 2400 MCI switch with an INTUITY system. The document contains instructions or information on the following topics.

- Switch integration planning strategies
- Switch Integration Device (SID) hardware installation instructions
- Software installation instructions
- NEAX 2400 administration instructions
- Acceptance test procedures
- Cut-to-Service procedures
- SID troubleshooting guide

The document contains information only for the NEAX switch integration with the INTUITY system. If you have another type of switch, refer to the switch integration document for that switch.

Intended Audiences

This document is designed primarily for the on-site AT&T-certified services technician, the customer's technical personnel, and the customer's NEAX services technician. Use the document to install INTUITY system integration-required hardware and software, perform acceptance tests, and perform cut-to-service. The customer or the customers' switch vendor should use the document when performing switch administration tasks and other customer required tasks.

Secondary audiences include the AT&T personnel shown in the following list.

- Field support
- The Technical Service Center (TSC)
- Provisioning project managers
- The Sales and Technical Resource Center (STRC)
- Helpline personnel
- Factory assemble, load, and test (ALT) personnel

Prerequisite Skills or Knowledge

Typical readers should understand AT&T computer systems, switches, and hardware and software installation procedures. AT&T provides and recommends INTUITY system training for customers. Customers should be familiar with the NEAX switch or contact their switch vendor.

Document Organization

- Chapter 1, "Introduction and Requirements for Integration", explains the INTUITY configuration and includes a component connectivity diagram that shows you each component in the configuration. The chapter also contains a hardware and software component checklist.
- Chapter 2, "Switch Integration Device Basics", explains the basic components of the SID and how to use the system *forms* or screens. The chapter contains SID hardware component descriptions and illustrations, menu, edit, and action form explanations, and provides basic help functions.
- Chapter 3, "Switch Integration Planning", helps you plan, track, and record the switch integration. The chapter includes instructions for completing SID and switch integration worksheets that you use throughout the document as you complete the integration.

- Chapter 4, "Hardware Installation", describes the installation of the SID, cables to the switch, and cables to the INTUITY system. This chapter only contains information for installing the hardware components required for the integration.
- Chapter 5, "Installing SID Software on the INTUITY System", contains instructions for installing the INTUITY system software required to integrate with the NEAX 2400 switch.
- Chapter 6, "Administering the INTUITY System for the NEAX Integration", contains instructions for administering an INTUITY system to integrate with the switch. The chapter includes instructions for setting the message waiting lamp parameters, setting the switch interface parameters, and associating the application and the switch interface.
- Chapter 7, "NEAX 2400 Switch Administration", contains information and instructions for administering a NEAX 2400 MCI switch to work with an INTUITY system.
- Chapter 8, "Switch Integration Device Administration", contains information and instructions for administering the SID to work with the INTUITY system.
- Chapter 9, "Acceptance Tests", provides instructions for the switch administration you must perform before you can continue with the acceptance tests.
- Chapter 10, "Cut-to-Service", provides instructions for the switch administration you must perform before you can continue with cut-to-service.
- Appendix A, "Troubleshooting and Error Logs", provides troubleshooting information to help you isolate and correct integration problems.
- Appendix B, "Using Views During Integration", provides information about the SID real-time views of the integration process.
- Appendix C, "Switch Administration for INTUITY Lodging", provides switch administration procedures if you have INTUITY Lodging.

The document also includes a list of common abbreviations, a glossary, and an index.

How to Use this Document

This document provides additional information you need to know when integrating a NEAX switch with an INTUITY system. Use this document as additional information with the following documents:

- *INTUITY MAP/5 Hardware Installation*, 585-310-146
- *INTUITY MAP/40 Hardware Installation*, 585-310-138
- *INTUITY MAP/100 Hardware Installation*, 585-310-139
- *INTUITY Software Installation*, 585-310-140

Do not perform any tasks in this document until you complete the required tasks in the installation documents.

Conventions Used

The following conventions were used in this book:

- Rounded boxes represent keyboard keys that you press.
For example, an instruction to press the enter key is shown as follows:
Press **ENTER**.
- Square boxes represent phone pad keys that you press.
For example, an instruction to press zero on the phone pad is shown as follows:
Press **0**.
- The word “enter” means to type a value and press **ENTER**.
For example, an instruction to type y and press **ENTER** is shown as follows:
Enter y to continue.
- Commands and text you type or enter appear in bold.
- Values, instructions, and prompts that you see on the screen are shown as follows:
Press any key to continue.
- Variables that the system supplies or that you must supply are shown in *italics*. For example, an error message including one of your filenames is shown as follows:
The file *filename* is formatted incorrectly
- The sequence of menu options that you must select to display a specific screen is shown as follows:

Begin at the Administration menu, and select the following sequence:

> Voice System Administration

> Voice Equipment

In this example, you would first access the Administration menu. Then you would select the Voice System Administration option to display the Voice System Administration menu. From that menu, you would select the Voice Equipment option to display the Voice Equipment screen. For information about how to select a menu option, see

Trademarks and Service Marks

The following trademarked products may be mentioned in this book:

Product Name	Company
5ESS™	Registered trademark of AT&T
AT™	Trademark of Hayes Microcomputer Products, Inc.
AUDIX®	Registered trademark of AT&T
BT-542B™	Trademark of BusLogic Inc.
COMSPHERE®	Registered trademark of AT&T Paradyne Corp.
CONVERSANT® Voice Information System	Registered trademark of AT&T
DEFINITY®	Registered trademark of AT&T
Dterm™	Trademark of NEC Telephones, Inc.
Equinox™	Trademark of Equinox Systems, Inc.
INTUITY™	Trademark of AT&T
MD110®	Registered trademark of Ericsson, Inc.
MEGAPLEX™	Trademark of Equinox Systems, Inc.
MEGAPORT™	Trademark of Equinox Systems, Inc.
Meridian™	Trademark of Northern Telecom Limited
Microcom Networking Protocol®	Registered trademark of Microcom, Inc.
NEAX™	Trademark of NEC Telephone, Inc.
NEC®	Registered trademark of NEC Inc.
Northern Telecom®	Registered trademark of Northern Telecom Limited
ORACLE™	Trademark of Oracle Corporation
Paradyne®	Registered trademark of AT&T
Phillips®	Registered trademark of Phillips Screw Company
SL-1™	Trademark of Northern Telecom Limited
TMI™	Trademark of Texas Micro Systems, Inc.
UNIX®	Registered trademark of UNIX Systems Laboratories, Inc.
VT100™	Trademark of Digital Equipment Corporation

Telephones,

Related Resources

In addition to this book, you may need to reference the following books:

Title	Order Number
<i>INTUITY System Description</i>	585-310-211
<i>INTUITY AUDIX Feature Descriptions</i>	585-310-212
<i>INTUITY Documentation Guide</i>	585-310-540
<i>Migration to the INTUITY System</i>	585-310-602
<i>INTUITY New System Planning</i>	585-310-603
<i>INTUITY MAP/5 Hardware Installation</i>	585-310-146
<i>INTUITY MAP/5 Installation Checklist</i>	585-310-147
<i>INTUITY MAP/40 Hardware Installation</i>	585-310-138
<i>INTUITY MAP/40 Installation Checklist</i>	585-310-141
<i>INTUITY MAP/100 Hardware Installation</i>	585-310-139
<i>INTUITY MAP/100 Installation Checklist</i>	585-310-137
<i>INTUITY Software Installation</i>	585-310-140
<i>INTUITY Integration with System 75 and DEFINITY Communications System G1 and G3</i>	585-310-214
<i>INTUITY Integration with System 85 and DEFINITY Communications System G2</i>	585-310-215
<i>INTUITY Integration with 5ESS</i>	585-310-219
<i>INTUITY Integration with DMS-100</i>	585-310-220
<i>Integration with NEAX</i>	585-310-216
<i>INTUITY AUDIX Digital Networking Administration</i>	585-310-533
<i>AMIS Analog Networking</i>	585-300-512
<i>INTUITY Intro Voice Response</i>	585-310-716
<i>INTUITY Platform Administration and Maintenance</i>	585-310-534
<i>INTUITY AUDIX Announcement Customization- American English</i>	585-310-535
<i>INTUITY AUDIX Announcement Customization- British English</i>	585-310-536
<i>INTUITY AUDIX Announcement Customization- Latin Spanish</i>	585-310-537

Title	Order Number
<i>INTUITY AUDIX Announcement Customization- French Canadian</i>	585-310-538
<i>AUDIX Administration and Data Acquisition Package</i>	585-302-502
<i>A Portable Guide to Voice Messaging</i>	585-300-701
<i>Voice Messaging Quick Reference</i>	585-300-702
<i>Multiple Personal Greetings Quick Reference</i>	585-300-705
<i>Voice Messaging Wallet Card</i>	585-300-704
<i>Outcalling Quick Reference</i>	585-310-721
<i>Voice Messaging Business Card Stickers</i>	585-304-705
<i>Voice Messaging Subscriber Artwork Package</i>	585-310-724

How to Make Comments About This Book

A reader comment card is behind the title page of this book. While we have tried to make this book fit your needs, we are interested in your suggestions for improving it and urge you to complete and return a reader comment card.

If the reader comment card has been removed, send your comments to:

AT&T
Product Documentation Development Department
Room 22-2C11
11900 North Pecos Street
Denver CO 80234-2703

Please include the title and order number of this book.

Introduction and Requirements for Integration

1

This chapter describes and defines requirements for the NEC NEAX 2400 MCI switch integration with an INTUITY Messaging System. The chapter includes diagrams and checklists that show the configuration for INTUITY Messaging System.

To create an integrated environment between INTUITY Messaging System and an NEC NEAX 2400 MCI switch, AT&T uses an electronic box called a Switch Integration Device (SID). The SID operates as a protocol converter between the switch and the INTUITY Messaging System, converting NEAX 2400 call information into Simplified Message Desk Interface (SMDI) format and sending the information to the application. The SID does not restrict any switch features.

For the SID to perform integrated call transactions, the switch must contain a Message Center Interface (MCI) link. The MCI link provides an RS-232 connection between the NEAX 2400 and the SID. The NEAX 2400 sends call information to the SID through the MCI link.

All channels reserved for the INTUITY Messaging System must be administered in a Uniform Call Distribution (UCD) group. The first channel in the UCD serves as the *forwarding* or central number for INTUITY Messaging System subscribers. After administering the switch, all covered and forwarded calls transfer to the first channel or central number of the UCD group. If the first channel is busy, the system searches through the other members of the UCD group until the system finds an open channel. Figure 1-1 shows you an example of an incoming call and the hunting process.

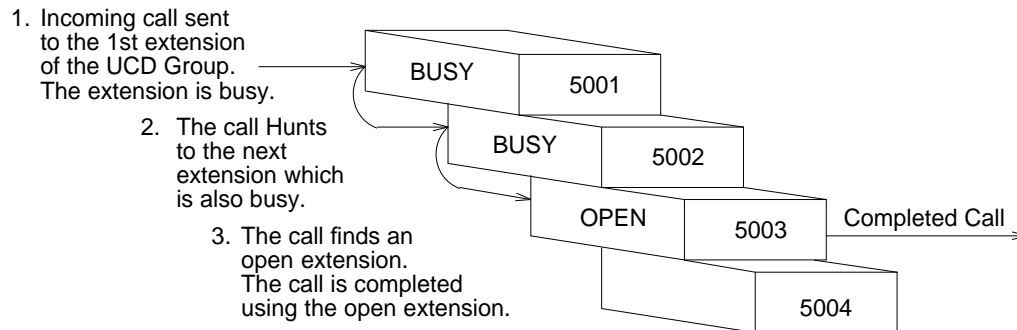

Figure 1-1 UCD Group Hunting Process

By administering the UCD group, you enable the switch to support the following features.

- Calling party information for incoming calls
- Call forward to a personal extension
- Set and cancel message waiting indications

Subscribers also use the UCD central number to access the INTUITY Messaging System.

Before you connect the NEAX 2400 MCI to the SID and the INTUITY System, confirm that you have all required hardware and software integration components. This chapter provides you with hardware and software diagrams, checklists, and explanations. Use the information to confirm that you have all required integration components.

Safety Considerations

**CAUTION:**

Electrostatic discharge damages electronic equipment. Do not touch any electronic component until you properly ground yourself.

To prevent damage to the equipment and yourself, follow these precautions:

- Familiarize yourself with the procedures necessary to prevent electrostatic damage to equipment.
- Shut off all power and remove all cables from equipment.
- Properly ground a work mat and wrist strap.
- Place the equipment on the work mat.
- Place the grounded wrist strap on your bare wrist. The wrist strap must contact your bare skin directly. *Do not* wear the wrist strap over your clothes.

Factory Assembled Systems

The factory performs assembly, load, and test (ALT) processes for most of the INTUITY hardware and software before shipping the system to the site. Use the information in this chapter to confirm that the system contains the hardware and software for your configuration.

After checking the installed hardware and software, perform all tasks not completed during ALT, such as connecting the voice and data lines, setting up and cabling the peripherals, and installing the switch communications software. Use one of the following checklists to make sure you complete all necessary tasks:

- *INTUITY MAP/5 Installation Checklist, 585-310-147*
- *INTUITY MAP/40 Installation Checklist, 585-310-137*
- *INTUITY MAP/100 Installation Checklist, 585-310-141*

Determining the Placement of the SID

The Switch Integration Device (SID) and the MAP/5, MAP/40, or MAP/100 represent *local* devices. Place the SID and the MAP in the same area and close enough together so the RS-232 cable supplied with the SID can connect to the computer. During installation, the AT&T technician will place the SID and the MAP in the location specified by the customer.

For the link between the MCI port and the INTUITY System, AT&T uses an Electronic Industries Association (EIA) RS-232-C serial data electrical interface. AT&T supplies an EIA standard RS-232 cable with a 25-pin connector. You cannot directly connect the cable to the switch. The MCI port on the backplane of the switch has a 25-pair connector. AT&T supplies the 25-pair to 25-pin adaptor required to connect the RS-232 cable to the backplane of the switch. The customer or the switch vendor representative must connect the adaptor to the switch. AT&T assumes responsibility only for the RS-232 cable that connects to the SID.

If the distance from the switch to the SID is longer than the RS-232 cable reaches, you, the customer, must supply a cable that attaches between the AT&T supplied cable and the NEAX 2400 MCI port adaptor. Use a cable that meets the EIA RS-232 standards, including the 50 feet maximum cable length. Failure to meet EIA communication standards may cause data transmission errors. If you cannot reach the switch with the 50 feet maximum cable length, you, the customer, must determine and engineer a method of connecting the SID and the switch, such as using a limited-distance modem. AT&T does not recommend any particular methods.

System Configuration

The Intuity system connects to the NEAX switch through a Switch Integration Device (SID). Figure 1-2 shows you the connections between an Intuity system and a NEAX switch through the multi-port serial card. Figure 1-3 shows you the connections between an Intuity system on a MAP/5 platform and a NEAX switch through COM1.

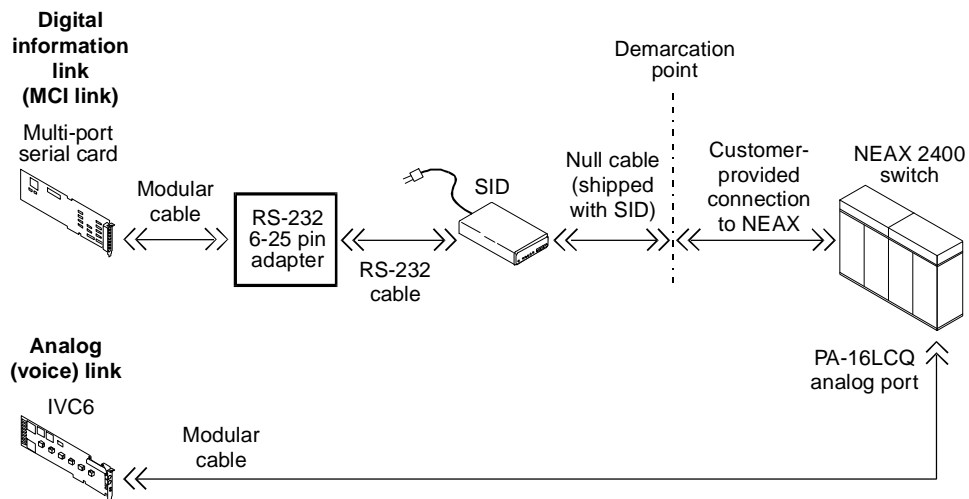

Figure 1-2 Connections through the Multiport Serial Card for an Intuity Integration with a NEAX Switch

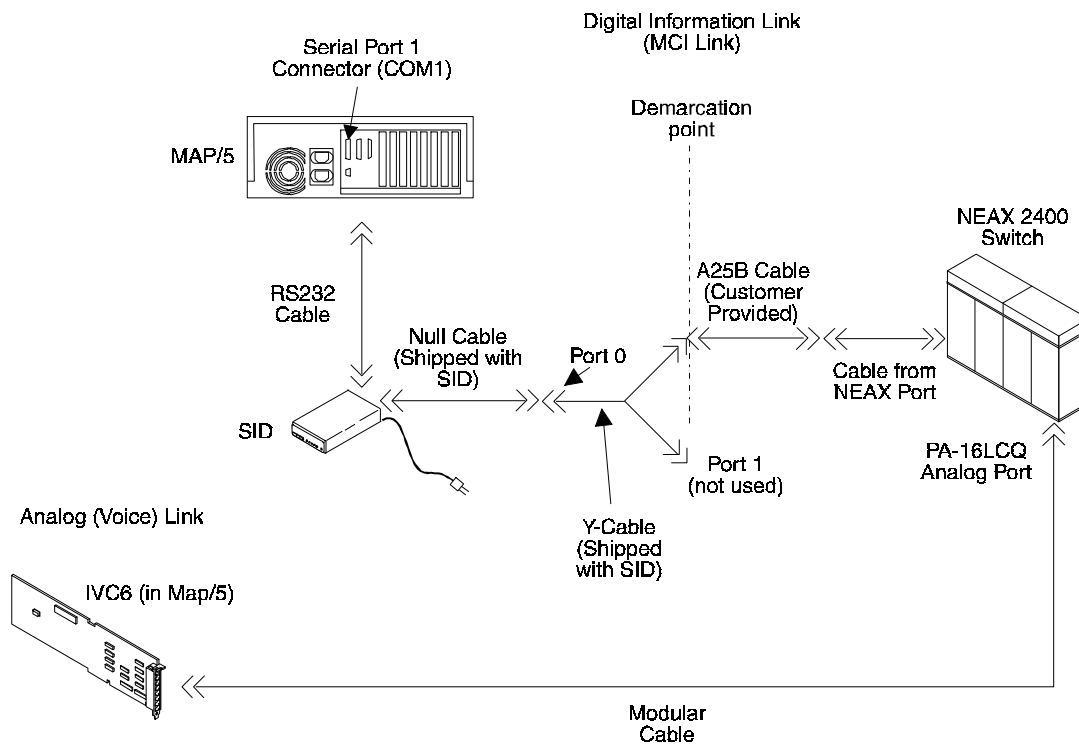

Figure 1-3 Connections through the COM 1 Serial Port for an Intuity Integration with a NEAX Switch (MAP/5 only)

Intuity System Required Hardware

Table 1-1 lists the hardware components required on the Intuity system for the NEAX integration.

Table 1-1. Intuity System Hardware Components Required for the Integration

Component	Description	AT&T Supplied	Customer Supplied
MAP/5, MAP/40, or MAP/100	Hardware platform that operates the Intuity system software	X	
IVC6 cards	Integrated Voice Processing (IVC6) cards used for voice port connections. May have a maximum of 11 cards. Includes any of the following hardware:	X	
	885A adaptors and cables	X	
	25-ft. modular cords with 6-pin to 25-pin adapters	X	
	Two high density cables, RJ21X, with a 356B adapter for T/R distribution	X	
Multiport serial port card	Equinox multiport card provides multiple serial ports for adjunct component connections. On the MAP/40 and MAP/100, the COM ports are occupied by other components and the Equinox card must be used for the SID connection. On the MAP/5, the COM1 port can be used for the SID connection.	X	
MAP5 only: RS-232 cable (DB-25)	For a COM1 connection on the MAP/5, an RS-232 cable, DB-25, is required to connect the SID to the Intuity system. The cable includes a 25-pin to 9-pin adapter (DB-9).	X	
Equinox connection only: RS-232 cable with 6-pin to 25-pin adapter	For a connection to the Equinox multiport serial card, an RS-232 cable with a 6-pin to 25-pin adapter is required.	X	

Switch Integration Device Required Hardware

Table 1-1 lists the required SID components for the integration.

Table 1-2. Switch Integration Device Hardware Components Required for the Integration

Component	Description	AT&T Supplied	Customer Supplied
SID	AT&T Switch Integration Device, Release 2	X	
Null Cable	Used for connection to SID	X	
Y-Cable	Used for connection from Null cable to customer A25B Cable	X	
A25B Cable	25-pair Amphenol female-to-female cable used to connect Y-Cable and NEAX port cable or MCI cable		X
MCI Cable	Cable that connects from the NEAX MCI digital port to the A25B cable		X



NOTE:

AT&T only assumes responsibility for connecting the Null cable and the Y-cable to the SID. All remaining connections must be performed by the customer or the customer's switch technician.

NEC NEAX 2400 MCI Hardware

The customer must provide the correct switch and related components as described in Table 1-3. All required items should be available and configured before an AT&T technician arrives to install the INTUITY system. The INTUITY system integrates only with the NEC NEAX 2400 switch and related components described in Table 1-3.

Table 1-3. NEAX Switch Required Components

Component	Description	AT&T Supplied	Customer Supplied
NEAX 2400 MCI Switch	<ul style="list-style-type: none"> ■ Models UMG and MMG with software level 4000 or greater with support for the MCI link ■ Models SIM and IMG with software level 5200 or greater with support for the MCI link ■ The switch must have the 5200 Feature Application Floppy Disk software installed. After installing the software, reboot the switch. 		X
MCI Digital Port	Configure an I/O port, for example PA-IO02, as the MCI link		X
PA-16LCQ analog ports	PA-16LCQ recommended because it can be programmed to provide loop current disconnect. An analog port is required for each voice port. An analog port is also needed for the internal modem on the SID.		X

In addition to the hardware and software listed in Table 1-3, you must provide the following administration on the NEAX 2400.

- Program the PA-16LCQ analog ports to provide an adequate loop current disconnect, or *wink*. The PA-16LCQ card provides a default value of approximately 128ms wink. The wink can be increased to approximately 448ms with a firmware upgrade from NEC. Without the upgrade and the increase, two items occur:
 - Call holding times increase substantially because the default disconnect time is lower than the minimum time required by the INTUITY System.
 - Call answer messages end with a reorder tone of approximately one second.
- Set the recall timer on the NEAX switch to an amount of time longer than the ring-no-answer time. If you do not, calls blind transferred to subscribers administered for *forward on ring-no-answer* recall back to the INTUITY System channel.
- Administer the INTUITY System to transfer calls to a station other than an actual attendant console, for example a digital telephone capable of displaying calling party information. The NEAX 2400 switch does not allow stations to transfer calls to an attendant console.

Switch Integration Device Basics

2

Before you attempt to operate and administer the Switch Integration Device (SID) and integrate an NEC NEAX 2400 MCI switch with an INTUITY System, you need to understand the hardware components of the SID and how to use the device. The information in this chapter explains the basic components of the SID and how to use the system *forms* or screens.

The chapter covers the following topics.

- SID hardware component descriptions
- SID hardware component illustrations
- Menu forms
- Edit forms
- Actions forms
- Help functions

Read the information in this chapter to understand the SID hardware and software.

The Switch Integration Device Hardware

Before you use the SID, you need to understand each hardware component. Read the descriptions below of each component and refer to Figure 2-1. to locate the component.

Front Panel

LCD display	A two-line, 40-character, backlit LCD display screen used to show all menus and information on the SID.
Diagnostic lights	LED lights used to indicate and trace possible problems in the SID. The LEDs help to determine if problems exist in the SID, the link to the PBX, the link to the INTUITY System, or any combination of the different links or systems. The Status LED lights when you power on the SID.
Keypad	A 19-key, membrane-style keypad used to select menu items, enter information, and perform all administration on the SID. The keys include ten numbered keys (0-9), four directional arrow keys, a pound sign (#)key, a star key (*), a Function key, a Mode key, and an Enter key. Chapter 8, "Switch Integration Device Administration", of this document contains tables that show the function of each key, if different than marked.

Rear Panel

Power switch	The toggle switch used to turn the SID on and off.
Power cord outlet	The male outlet where you plug in the power cord shipped with the SID.
Link A and Link B	Two RS-232 ports used to connect the SID to the PBX and the INTUITY System. Chapter 4, "Hardware Installation", of this document explains the proper connections for the two ports. (Detail 25 pin)
Modem port	The SID contains an internal modem used for diagnostic and software upgrade purposes. Use the modem port to connect the SID's modem to an analog line.

Continue to the next section, "Using the SID Software," for an explanation of how to use the SID displays and menus.

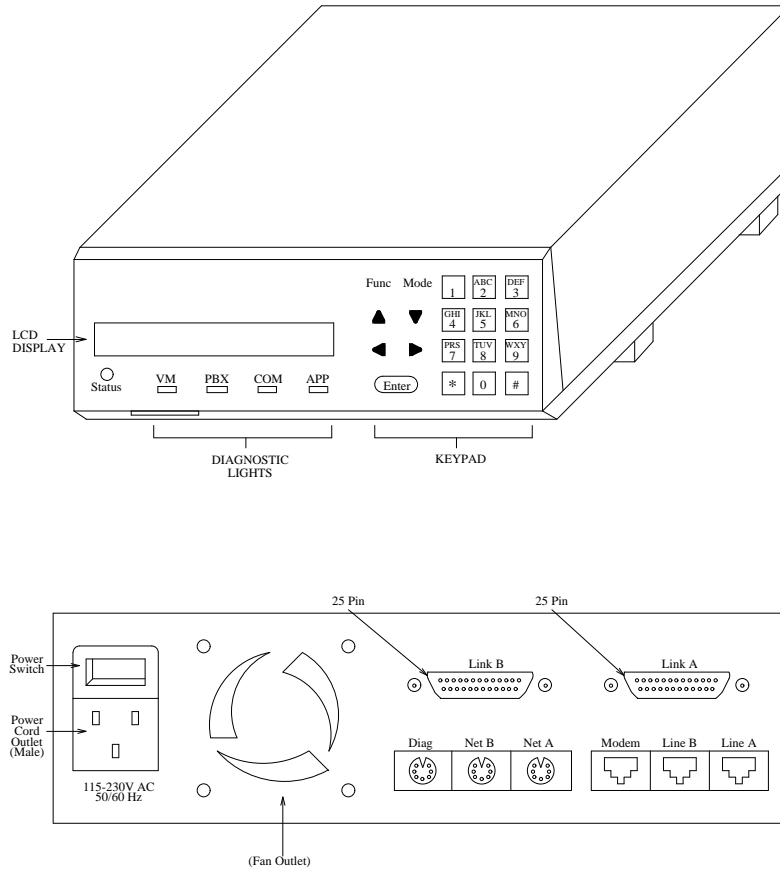

Figure 2-1. Top: SID Front Panel Bottom: SID Back Panel

The Switch Integration Device Software

The SID contains software that allows you to perform installation, configuration, and diagnostic tasks by using the keypad and the LCD screen. As you administer the SID, you use three types of forms or screen displays. Each type of form has a specific task.

- Menu Forms — used to select one of several options.
- Edit Forms — used to enter information into the SID's configuration.
- Action Forms — used to perform an action, view event logs, or monitor the system.

This section contains descriptions and examples of each form and provides you with instructions for using the forms. You also can find tables that show you valid key actions for each form.

Menu Forms

Menu forms allow you to select options by pressing a key. You can select another menu, an edit form, or an action form. The menu forms allow you to move between important forms by pressing only a few keys. Figure 2-2. shows you the MCI User Interface Main Menu.

NEC	1-View	2-Utills	3-System
	4-Setup	5-Logs	

Figure 2-2. The MCI User Interface Main Menu

A menu form contains two items:

Name	You can find the menu name in the upper left hand corner of the LCD display. Use the name as a reference item.
List of options	Menus show you different options. Each option has a number and a label. Not all menus contain the same number of options. To select an option from a menu, press the option number on the keypad. The SID clears the current form from the LCD display and places the form you selected on the display. The label you selected appears as the name of the form.

Example: If you wanted option 4, SETUP, from the MCI User Interface Main Menu shown in Figure 2-2., press **4** on the keypad. After you press **4**, you see the SETUP form appear on the screen as shown in Figure 2-3..

SETUP	1-Params	2-Ports	3-Clear
	4-Advanced		

Figure 2-3. The Setup Form

The SID uses menus to organize all options and functions into categories. Menus also permit the user to navigate easily through the forms by pressing one or more keys.

Each type of form requires you to use different keys on the keypad to make selections and enter information. The table below shows you what keys to use with the menu forms.

Key	Action
1,2,3,4,5,6,7,8,9,0	Select menu option
*,#	No action
Func	Return to main menu
Mode	No action
Arrows	No action
Enter	No action

Edit Forms

Edit forms allow you to use the keypad to enter information into the SID's configuration. There are three types of edit forms:

- Single Item
- Two Item
- Scroll Item

This section contains descriptions and examples of each type of edit form and provides you with instructions for using the forms.

Single Item Edit Forms

On a Single Item Edit form, you must enter one piece of information or answer one question. Figure 2-4. shows you an example of a single item edit form, the SETUP form. On the form, you need to enter the number of ports assigned to the INTUITY System. In this example, you enter the appropriate value using the digits on the keypad and press (ENTER).

```

SETUP                Number of Ports                -----
  
```

Figure 2-4. The Setup Form

Two Item Edit Forms

Two Item Edit forms ask two related questions. After you answer the first question and press (ENTER), the cursor moves to the second line. You must now enter information for the second question. When you press (ENTER) the second time, the cursor *wraps* or moves back to the first line. If you have entered all information correctly, press (▲) or (▼) to move to the next edit form. You can (FUNC) to return to Main Menu. If you did not enter the information correctly, you can change the information until you have everything correct. Figure 2-5. shows you the VM Port form, an example of a two item edit form.

```

VM Port      LTN:                -----
              Extension:         -----
  
```

Figure 2-5. The VM Port Form

Scroll Item Edit Forms

Scroll Item Edit forms ask questions that have a limited number of answers. The SID places a default value in the field, but allows you to *scroll* or search through the options. You use the left and right arrow keys on the keypad to scroll through the options. Figure 2-6. shows you a sample scroll item edit form, the MCI form.

```

MCI                Baud Rate:                1200
<- ->1
  
```

Figure 2-6. The MCI Form

In the example, you use the MCI form to set the baud rate for the MCI link. You can set the baud rate to specific values between 300 and 9600 baud. On the form you see a default value of 1200. To see the other options, you press the left arrow key to decrease the baud rate or press the right arrow key to increase the rate. When you find the rate you want, press **ENTER** to confirm your choice. You can recognize scroll item edit forms by the small arrow symbols (< - >) shown below the form name.

Edit Form Keys

Edit forms require you to enter data for SID setup and configuration. Most edit forms have default values already entered on them. If you choose to use the default value, press **FUNC** to exit the form. As you edit forms, you can move to the next or previous edit form, return to the main menu, or access a help screen. Refer to the table below for a list of keys and the action each key performs.

Key	Action
1,2,3,4,5,6,7,8,9,0	Data entry keys
*,#	Data entry keys
Func	Return to main menu
Mode	Help
Up Arrow	Go to previous edit form
Down Arrow	Go to next edit form
Right Arrow	Get higher value
Left Arrow	Get lower value
Enter	Confirm entry

With some menu selections, you can access multiple edit forms that link together. When you access multiple edit forms, press **▼** to move to the next form or press **▲** to move to the previous form.

Edit Form Help Functions

Edit forms allow you to actively access help screens. To access the help screen, press **(MODE)** at any edit form. The SID places the help screen on the LCD display. The SID retains any information you may have entered on the edit form and places the edit form with your information back on the display when you exit the help screen. You do not lose any information. Most help screens appear as shown in Figure 2-7., although certain edit forms add or delete options.

EDIT	1-Overtype	2-Insert	3-Clear
	4-Undo		

Figure 2-7. Help Screen Options Accessed From an Edit Form

The following list shows you each available option and explains the action of each option shown on the help screen.

Overtype	The option places the editor into a mode that allows you to enter new characters over existing characters.
Insert	The option changes the editor into a mode that allows you to insert new characters between existing characters.
Clear	The option erases all characters in the field.
Undo	The option replaces any new information typed in the field with information from the stored configuration.

Action Forms

Action Forms provide you with a *window* or a view into the integration application. With action forms, you can monitor the application activity, review event logs, or check statistical information. Figure 2-8. shows a sample action form, the Statistics View form.

STATISTICS VIEW			
Calls:	12481	MWIs:	10412

Figure 2-8. The Statistic View Action Form

Action forms operate in a dynamic or real-time mode. The screen changes with each transaction processed by the SID. When you finish observing an action form, you can press **(FUNC)** to return to the main menu. You also can **(MODE)** to access any available help options for the action form. Although not all action forms have help options, by pressing **(MODE)** you usually can find optional ways to look at the information presented on the action form.

All action forms use the same keys on the keypad to perform functions and make selections. The table below shows you what keys to use with the action forms.

Key	Action
1,2,3,4,5,6,7,8,9,0	No action
*,#	No action
Func	Return to main menu
Mode	Help for Action Form
Arrows	No action
Enter	No action

You have read the basic information necessary to integrate and INTUITY System with an NEC NEAX 2400 MCI switch. Proceed to Chapter 3, "Switch Integration Planning", to plan the switch integration and prepare for the installation and administration procedures.

Switch Integration Planning

3

Before you implement the NEC NEAX 2400 Message Center Interface (MCI) integration with an INTUITY System, you must plan the process. This chapter provides worksheets and information to help you plan and record the integration. You use the worksheets later to complete the switch integration process.

By completing the worksheets you collect the following information:

- Number of voice mail ports
- Message desk number
- Calling party identification pad string
- Message waiting indicator pad string
- Message waiting indicator features
- Extensions/Logical terminal number plan
- Message center interface baud rate
- Simplified message desk interface baud rate

Continue with the instructions on the next page to plan the switch integration.

Determining the Number of Voice Mail Ports

You must specify the number of voice mail ports for the Switch Integration Device (SID) to support and monitor.

The number of ports for the SID is the same as the number of ports assigned to the INTUITY System. The maximum number of supported lines depends on the switch software level. Your switch software must support the UCD overflow feature. The SID assigns a default value of 140 to this field. To find the number of voice ports assigned on the INTUITY System, refer to *INTUITY New System Planning*, 585-310-603. After you determine the number of voice mail ports you need to assign on the SID, write the number on line 1 of Worksheet A.

Worksheet A: Switch Integration Information

Line	Field or Feature Name	Value
1	Number of voice mail ports:	
2	Message Desk Number:	001
3	CPID Pad String Number:	0000000
4	MWI Pad String Number:	0000000
5	MWI Feature: (ENABLE = on, DISABLE = off)	
6	MCI Baud Rate:	
7	SMDI Baud Rate:	

Setting the Message Desk Number

The Simplified Message Desk Interface (SMDI) message desk number must match the number assigned on the voice mail system. For an INTUITY System, use the default value assigned to the SID. The default value is 001. Line 2 of Worksheet A already contains the value 001 as the message desk number.

Setting the Calling Party Identification Pad String

The Message Center Interface (MCI) protocol, used by the NEAX 2400 switch to communicate with the SID, provides calling and called party information consistent with the dial plan administered on the switch. The SID operates on Simplified Message Desk Interface (SMDI) protocol which uses a seven-digit field. To compensate for the difference between the MCI and SMDI protocols, the SID uses a seven-digit string, called the Calling Party Identification Pad (CPID) string, that the SID overwrites with caller identification information. The SID assigns the field a default value of 0000000. For an INTUITY System, use the default CPID string of 0000000. Line 3 of Worksheet A already contains the value 0000000 as the CPID pad string.

Example: If you set the CPID pad string to 0000000 and the SID receives a caller ID of 245, the SMDI caller ID information becomes 0000245.

Setting the Message Waiting Indicator Pad String

The Message Waiting Indicator (MWI) Pad String operates on the same basis as the CPID Pad String. As with the CPID Pad String, the SID uses a seven-digit string, called the Message Waiting Indicator (MWI) pad string, that informs the SID about the format of MWI information generated by an INTUITY System. The SID uses the MWI pad string to strip off digits not required by MCI. The SID assigns a default MWI pad string of 0000000. For an INTUITY System, use the default MWI pad string of 0000000. Line 4 of Worksheet A already contains the value 0000000 as the MWI pad string.

Setting the Message Waiting Indicator Feature

The MWI feature enables the INTUITY System to activate message waiting lamps. The SID sets the default value for this field to ENABLE, which activates the MWI feature. If you do not want the INTUITY System to activate the MWIs, change the field to DISABLE. Write the value on line 5 of Worksheet A.

Determining the Message Center Interface Baud Rate

You must set the baud rate for the MCI link. The SID provides baud rate selections of 300, 1200, 2400, and 9600 baud and sets a default of 1200 baud. Make sure that the baud rate equals the dip switch settings on the MCI link switch I/O card. Write the MCI link baud rate on line 6 of Worksheet A. If you plan to use the default setting, write 1200 on the worksheet.

Determining the SMDI Baud Rate

You must set the baud rate for the Simplified Message Desk Interface (SMDI) link. The SID provides baud rate selections of 300, 1200, 2400, and 9600 baud and sets a default of 1200 baud. AT&T recommends that you use a baud rate of 2400. Write the SMDI link baud rate on line 7 of Worksheet A.

Determining the Extension/Logical Terminal Number Plan

On the INTUITY System, you assign a channel to each extension to allow for switch communications. For the SID application, you associate a Logical Terminal Number (LTN) with each analog extension number used by the INTUITY System.

For example, if you assign channel 0 to extension 2222 on the INTUITY System, you assign LTN 1 (0001) to the extension on the SID. Assigning the LTN to an extension tells the SID where to send information for the extension. If you do not assign the LTNs, the SID does not integrate calls properly.



NOTE:

The INTUITY System uses 0 as the first channel number assigned to an extension. The SID assigns 1 as the first LTN assigned to an extension. As you assign channels and LTNs, the number is always one greater than the number assigned on the INTUITY System.

To assign LTNs and extensions on the SID, refer to the planning document or have your switch administrator list the extensions of all the analog ports assigned on the INTUITY System. Use Worksheet B on the next page to record the LTNs, channels, and extensions. After you complete all of the worksheets, proceed to Chapter 4, "Hardware Installation".

Worksheet B: Extension/LTN Plan

Extension	LTN	Extension	LTN
	1		2
	3		4
	5		6
	7		8
	9		10
	11		12
	13		14
	15		16
	17		18
	19		20
	21		22
	23		24
	25		26
	27		28
	29		30
	31		32
	33		34
	35		36
	37		38
	39		40
	41		42
	43		44
	45		46
	47		48
	49		50
	51		52
	53		54
	55		56
	57		58
	59		60
	61		62
	63		64

This chapter describes the hardware and cable installation tasks required to integrate the NEAX 2400 MCI switch with an INTUITY System through a switch integration device (SID). Before you proceed with the instructions in this chapter, verify that the hardware has been installed and that all required steps have been completed on one of the following checklists:

- *INTUITY MAP/5 Installation Checklist, 585-310-147*
- *INTUITY MAP/40 Installation Checklist, 585-310-141*
- *INTUITY MAP/100 Installation Checklist, 585-310-137*

This chapter covers the installation of all integration-related hardware components. The tasks must be performed by the AT&T installation technician, the customer, or the customer's switch technician. Each task provides an explanation of who should perform the task.

The hardware installation tasks covered in this chapter include:

- Connect an analog line to the modem
- Connect the MCI line to the switch
- Connect the MCI cable to the A25B cable
- Connect the Null cable and the Y-cable to the SID
- Connect the SID to the INTUITY system
- Connect the SID power cord

Continue with the instructions on the next page to install the hardware.

Connect an Analog Line to the Modem

This task should be performed by the AT&T installation technician and the customer or the customer's switch technician.

The SID contains an internal modem that allows for remote site access and maintenance. You must connect an analog line from the switch to the remote modem to allow for maintenance. Connect the analog line to the switch before the AT&T installation technician arrives.

Use the following procedure to connect the analog line to the modem.

1. Connect the analog line to the MODEM port on the SID, as shown in Figure 4-1.

Proceed to the next task.

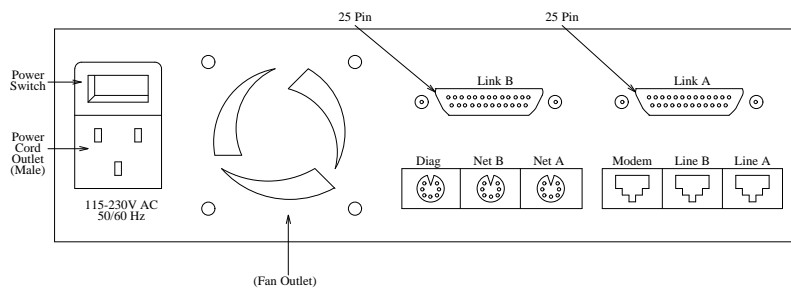

Figure 4-1. Back View of the SID

Connect the MCI Line to the Switch

The customer or the customer's switch technician must complete this task. AT&T does not assume responsibility for any cable connections to the NEAX 2400 switch.

The NEAX 2400 switch communicates with the SID through a Message Center Interface (MCI) link. To connect the link, the customer must provide a cable to connect to the MCI digital port and also provide an A25B cable to connect to the MCI cable. Figure 4-2 shows all of the cables and connections required for the integration.

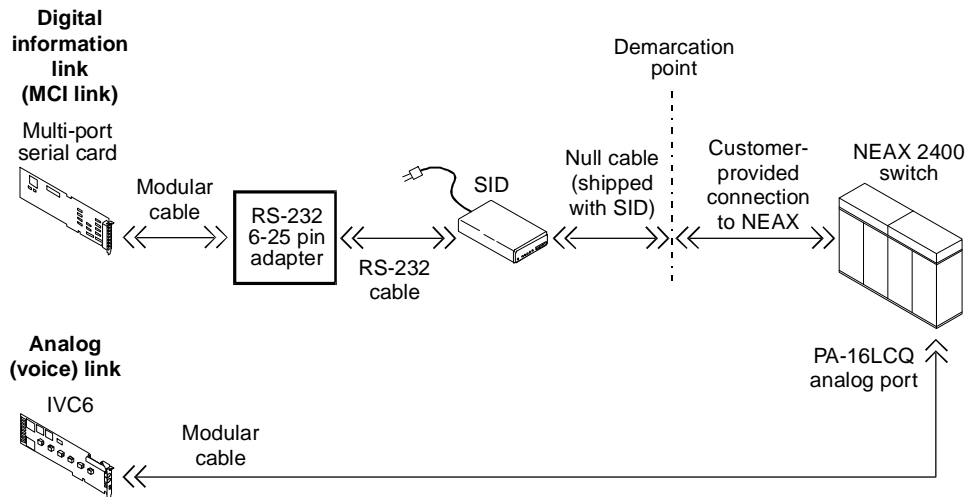

Figure 4-2. NEAX Connections to the INTUITY System



NOTE:

To reduce the chance for data communication errors, do not exceed the Electronics Industry of America (EIA) RS-232 standard cable length of 50 feet.

Use the following instructions to connect the MCI line to the NEAX 2400 switch.

1. Set the MCI I/O port (PN PAIO02) at the same baud rate as the SID, 2400 baud. Use Table 4-1 to set the DIP switches on the MCI I/O port.



NOTE:

To set the baud rate for the MCI Link, you must set switches 1, 2, and 3 in a specific combination. For example, to set the baud rate at 2400BPS, set switch 1 to ON, switch 2 to OFF, and switch 3 to OFF.

Table 4-1. MCI I/O Port DIP-Switch SW01 or SW11 Settings for Switches 1 through 3

Switch Number	1	2	3	Function
Settings	ON	ON	ON	300BPS
	ON	ON	OFF	600BPS
	ON	OFF	ON	1200BPS
	ON	OFF	OFF	2400BPS
	OFF	ON	ON	4800BPS
	OFF	ON	OFF	9600BPS

2. Set the parity of the MCI link to **even** and the word length to **7** bits.

Use Table 4-2 and Table 4-3 to set the DIP-switches on the MCI I/O card in the switch.

⇒ NOTE:

If you need more information for setting the baud rate, parity, and DIP-switches on the NEAX 2400 MCI port, refer to the documentation supplied with your switch or contact your switch service representative.

Table 4-2. MCI I/O Port DIP-Switch SW01 or SW11 Settings for Switches 4 through 8

Switch Number	Setting	Function
4	ON	Parity bit valid
	OFF	Parity bit invalid
5	ON	Odd parity
	OFF	Even parity
6	ON	7 bits
	OFF	8 bits
7	ON	1 stop bit
	OFF	2 stop bits
8	ON	Send side FIFO is 1 byte
	OFF	Send side FIFO is 64 bytes

Table 4-3. MCI I/O Port DIP-Switch SW02 or SW12 Settings for Switches 1 through 8

Switch Number	Setting	Function
1	ON	When PB lead is - terminal is busy
	OFF	When PB lead is + terminal is busy
2	ON	DTR signal is always ON
	OFF	DTR signal is controlled by the CPU
3	ON	DSR signal is not provided
	OFF	DSR signal is provided
4	ON	CD is not provided
	OFF	CD is provided
5	ON	CS is not provided
	OFF	CS is provided
6	ON	CI is not provided
	OFF	CI is provided
7	ON	PB signal is not provided
	OFF	PB signal is provided
8	OFF	Not used

**NOTE:**

Recommended Default Settings:

- If you use port 0, configure switches 01 and 02. If you use port 1, configure switches 11 and 12.
- Standard switch settings for SW01 or SW11 are 1 ON, 2 OFF, 3 ON, 4 OFF, 5 OFF, 6 OFF, 7 ON, and 8 ON.
- Standard switch settings for SW02 or SW12 are 1 ON, 2 ON, 3 ON, 4 ON, 5 ON, 6 ON, 7 ON, and 8 OFF.

3. Connect one end of a 25-pair cable to the MCI I/O port on the switch.

To create the cable, refer to Table 4-4 for the correct cable pinouts.

Table 4-4. Cable Pinouts

NEAX 2400 25 Pair	RS-232 Function	RS-232 Pin Number
Port 0		
Violet/Slate	Frame Ground	1
Blue/White	Transmit Data	3
Orange/White	Receive Data	2
Blue/Red	Signal Ground	7
Port 1		
Violet/Slate	Frame Ground	1
Green/Black	Transmit Data	3
Brown/Black	Receive Data	2
Green/Yellow	Signal Ground	7

Proceed to the next section.

Connect the MCI Cable to the A25B Cable

The customer or the customer's switch technician must connect the cable. AT&T does not assume responsibility for connecting the MCI cable and the A25B cable.

After connecting the MCI cable to the switch, you must connect the MCI cable to the A25B 25-pair Amphenol cable. Use the following instructions to complete the connection.

1. Connect the free end of the MCI cable to one end of the A25B cable.
2. Connect the free end of the A25B cable to the Amphenol connector on the Y-cable shipped with the SID.

Proceed to the next section.

Connect the Null Cable and the Y-Cable to the SID

The AT&T installation technician, the customer, or the customer's switch technician must complete this task.

The NEAX 2400 switch communicates with the SID through a Message Center Interface (MCI) link. To connect the SID to the MCI digital port, you must connect a Null cable and a Y-cable to the SID. Use the following instructions to connect the cables to the SID.

1. Connect one end of the Null cable to the 25-pin **Link B** on the SID, shown in Figure 4-3.
2. Connect Port 0 of the Y-cable to the free end of the Null cable.



NOTE:

Port 1 on the Y-cable is not used for any connections with this integration.

Proceed to the next section.

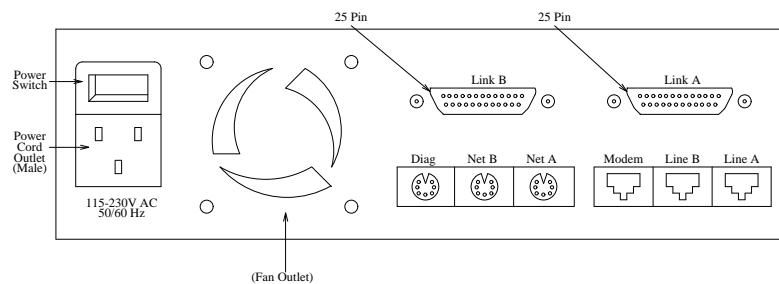

Figure 4-3. Back View of the SID

Connect the SID to the INTUITY System

This task requires you to connect the 6' RS-232 cable to the SID and to the INTUITY System and should be completed by the AT&T installation technician. The cable connects directly to the SID and connects to the INTUITY system through a 6-to-25-pin adaptor and a modular cable. Use the following instructions to connect the SID to the INTUITY System.

1. Connect the 25-pin RS-232 connector to **Link A** on the back of the SID. Figure 4-3 shows you the location of Link A.
2. Connect the 25-pin end of the 6-to-25-pin adaptor to the free end of the RS-232 cable.



NOTE:

If you are connecting the SID to a MAP/5 through the COM1 port, you do not need the adaptor. Connect the free end of the RS-232 cable to the COM1 port.

3. Plug the modular cable into the 6-to-25-pin adaptor.
4. Plug the free end of the modular cable into the multiport serial card in the MAP/5, MAP/40, or MAP/100 platform.

Proceed to the next section.

Connect the SID Power Cord

The AT&T installation technician or the customer must complete this task.

1. Plug the female end of the power cord into the AC power-in socket on the SID, shown in Figure 4-3.
2. Plug the male end of the power cord into the AC outlet provided by the customer.
3. Locate the power switch on the back of the SID, shown in Figure 4-3.
4. Toggle the power switch to the *ON* position.

When you turn on the power switch, the Status LED on the front of the SID illuminates.

You have completed the hardware installation steps required for the NEAX 2400 integration. Proceed to Chapter 5, "Installing SID Software on the INTUITY System", in this document.

Installing SID Software on the INTUITY System

5

This chapter provides procedures for installing the SID software on the INTUITY system.

⇒ NOTE:

Before you install the SID software, make sure that the voice system and maintenance software are installed. Also, ensure that no other switch software is already installed.

To install the SID software, perform the following 4 procedures:

1. Stop the voice system.
2. Load the SID software.
3. Start the voice system.
4. Turn on INTUITY AUDIX transfer feature.

Each of these procedures is described in the following sections.

Requirements

Before you install the SID software, note the following requirements:

Login: **craft**
Materials: SID Switch Integration
 Software (2 floppy disks)

Stop the Voice System

Before you can load the SID software, you must stop the voice system.

 **CAUTION:**
All calls in progress will be disconnected.

Use the following procedure to stop the voice system.

1. Login as **craft**.
2. Press **(ENTER)** to accept the AT386 default.
You see the INTUITY Administration menu.
3. Select the following series of menu options:

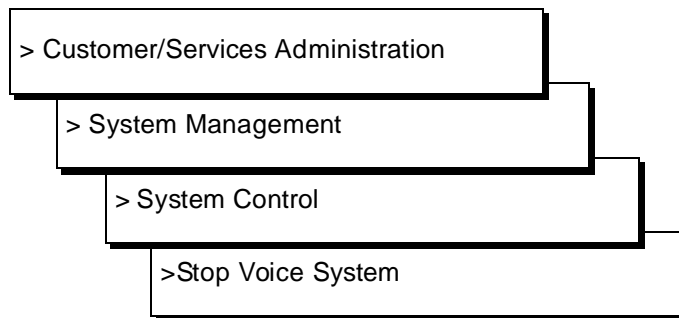

After you select the last option, Stop Voice System, you receive the following message:

```
Enter y to continue, n to quit.
```

4. Enter **y** to begin the process.

Before stopping the voice system, the system pauses until all calls in progress disconnect. During the pause, you see a series of messages.

When all calls have disconnected, you receive the following message:

```
The Voice System has stopped
Press ENTER to continue...
```

5. Press **(ENTER)**.

The system returns you to the System Control menu.

6. Press **(CANCEL)** until you see the INTUITY Administration menu.

You are now ready to load the SID software, as described in the next section.

Load the SID Software

1. Starting at the INTUITY Administration menu, select the following series of menu options:

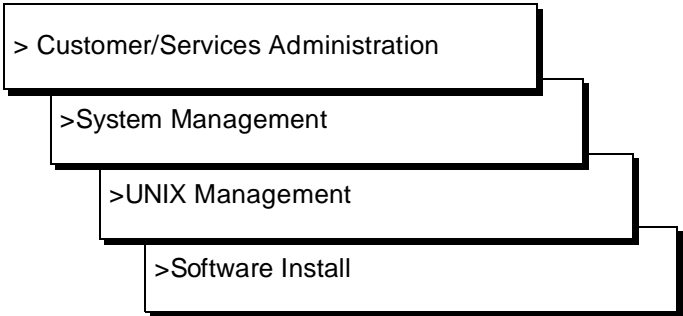

After you select the last option, you see the Software Install menu, as shown in Figure 5-1.

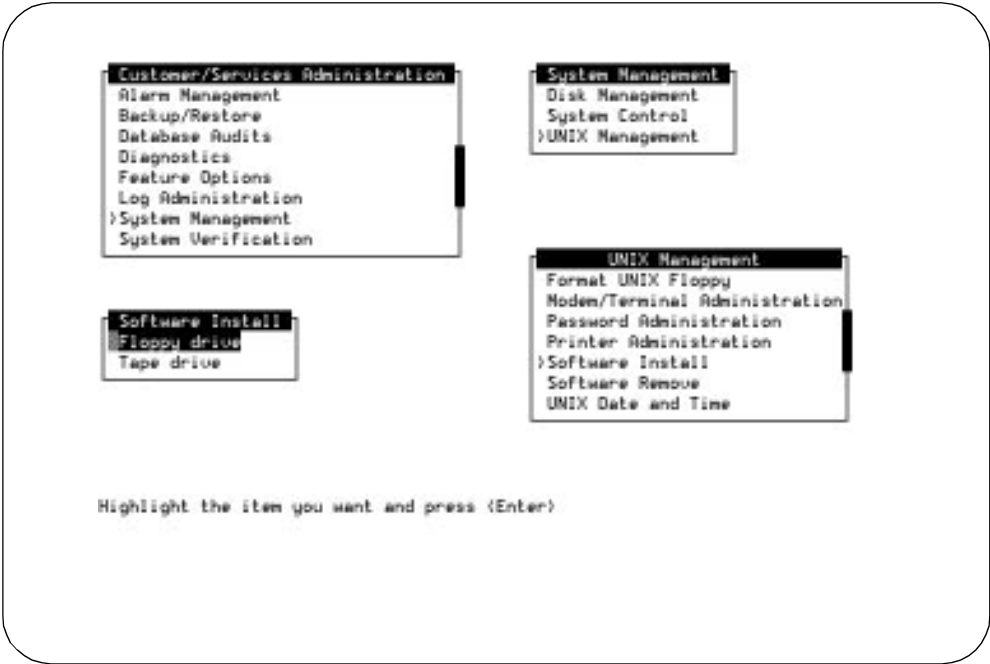

Figure 5-1. Software Install Menu

2. Select **Floppy drive** from the Software Install menu.

The system responds:

```
Insert diskette into Floppy Drive 1.  
Type [go] when ready  
or [q] to quit: (default: go)
```

3. Insert SID Switch Integration Package Disk 1 of 2 into the 3.5" floppy drive.
4. Press **(ENTER)** to install the software.

The system responds:

```
Installation in progress. Do not remove the diskette.
```

```
The following packages are available:
```

```
1 sid INTUITY SID Switch Integration Package  
(486) 1.0-16
```

```
Select package(s) you wish to process (or 'all' to  
process all packages). (default: all) [?, ??, q]
```

5. Press **(ENTER)** to accept the default of all.

You will see a series of messages indicating that the software is being installed including a copyright statement. The system pauses at the following prompt:

```
Select type of switch:
```

```
1) NEAX  
2) ROLM  
3) MITEL  
4) NORTHERN  
5) QUIT
```

```
Enter Selection:
```

6. Enter **1** to select NEAX. You receive the following confirmation message:

```
Confirm: You selected option 1. (y/n)
```

7. Enter **y** to select yes. The installation continues. The system pauses when you see the following prompt:

```
Insert diskette 2 of 2 into Floppy Drive 1.  
Type [go] when ready  
or [q] to quit: (default: go)
```

8. Remove Disk 1 of 2 from the floppy drive.
9. Insert Disk 2 of 2 into the floppy drive.
10. Press **(ENTER)** to continue the installation.

Following several screen messages, you see the Switch Link Administration screen as shown in Figure 5-2. The screen contains the system defaults that are automatically set when you load the software.

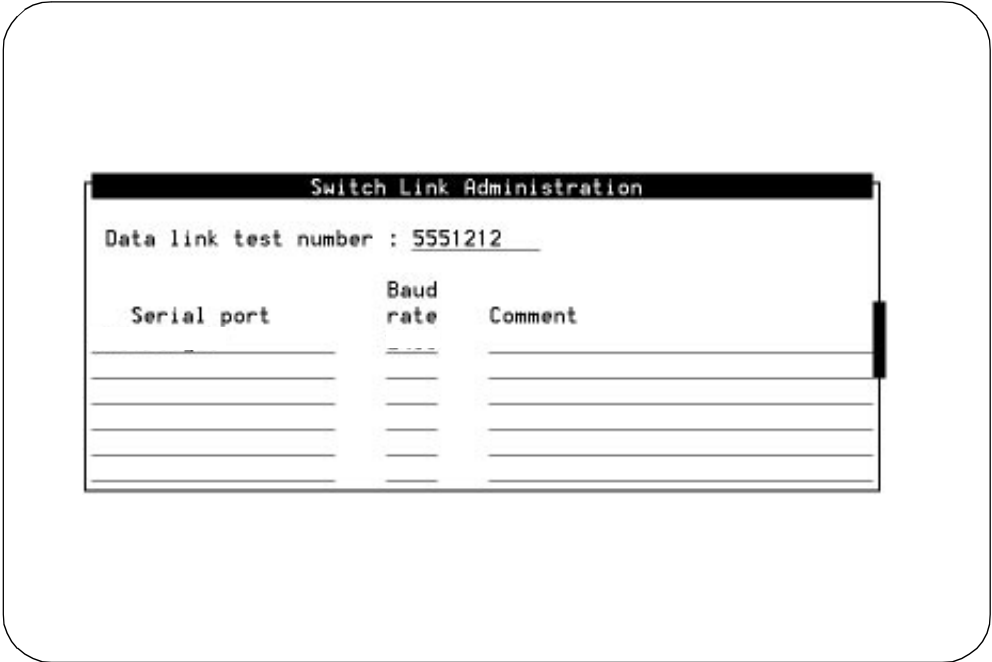

Figure 5-2. Switch Link Administration Screen with System Defaults

11. Use Table 5-1 to enter the correct values in each field on the Switch Link Administration screen.

Table 5-1. Switch Link Administration Screen Entries

Field	Description
Data link test number	<p>Indicates the test number sent to the switch to verify whether the switch is active.</p> <p>Setting: A 7- or 10-digit number that is <i>not</i> an in-service extension number. The number of digits must agree with the setting for the dialstring size set on the SID. Refer to Chapter 3, "Switch Integration Planning", to find the dialstring size.</p>
Serial port	<p>Indicates which port on the multi-port circuit card in the INTUITY system is connected to the integration device.</p> <p>Setting: Press (CHOICES) (F2) to choose from a menu of available ports. Settings are in the format /dev/ttysax, where x is a letter a - h representing a port on the circuit card (from right to left). AT&T recommends that you use /dev/ttysaa as the serial port.</p>
Baud rate	<p>Indicates the rate at which the SID and the INTUITY system communicate.</p> <p>Setting: A baud rate of 1200, 2400, 4800, or 9600. Press (CHOICES) (F2) to choose from a menu of possible settings. This setting must agree the BAUD setting on the SID. AT&T recommends that you use a baud rate of 2400.</p>
Comment	<p>Use the field to enter a comment. Enter a maximum of 30 characters. In your comment, do not use double quotation marks (") (SHIFT) + backsl (\).</p>

12. Press **SAVE** (F3).

After you press the key, you receive a confirmation message as shown in Figure 5-3. The message tells you that the serial port was registered successfully and that you need to start the voice system

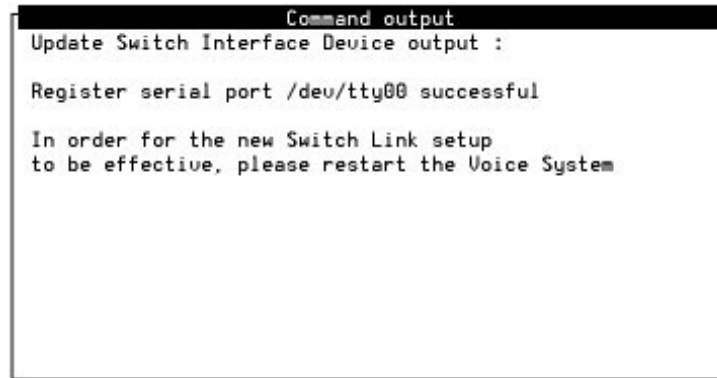

```

Command output
Update Switch Interface Device output :
Register serial port /dev/tty00 successful

In order for the new Switch Link setup
to be effective, please restart the Voice System
  
```

Figure 5-3 Switch Link Administration Confirmation Message

13. Press **CANCEL** (F6).

You see the Switch Link Administration screen.

14. Press **CANCEL** (F6) again.

You see ~~several~~ messages indicating that the installation is still running. When the installation process finishes, you see the following messages:

```
Installation of INTUITY SID Integration Package (sid)
was successful.
```

```
Insert a diskette into Floppy Drive 1.
Type [go] when ready
or [q] to quit: (default: go)
```

15. Remove Disk 2 of 2 from the floppy drive.

16. Enter **q** to quit.

The Software Install screen is redisplayed.

17. Press **CANCEL** until you see the INTUITY Administration menu.

Restart the voice system as described in the next section.

Start the Voice System

Restart the voice system for the INTUITY system to accept and process calls. Use the following procedure to start the voice system.

1. Starting at the INTUITY Administration menu, select the following series of menu options:

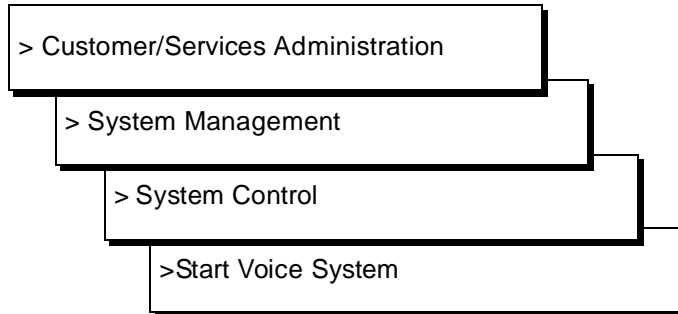

You see messages indicating that the voice system is being restarted.

When the process finishes, you see the following message:

```
Startup of the Voice System is complete  
Press ENTER to continue...
```

2. Press **(ENTER)**.
You see the System Control menu.
3. Press **(CANCEL)** until you see the INTUITY Administration menu.

Turn on Transfer Feature

After you install the NEAX software and restart the voice system, you need to turn on the transfer feature in INTUITY AUDIX. For this procedure, see *INTUITY AUDIX Administration*, 585-310-539, and set the transfer type field to *basic*.

Administering the INTUITY System for the NEAX Integration

6

This chapter describes how to administer the INTUITY system for integration with the NEAX switch. To integrate with the NEAX switch, the INTUITY system needs to know specific information about how the integration is set up, such as the serial port and baud rate being used. To administer the INTUITY system, you must complete the following screens:

- Switch Link Administration screen
- System Translation screen

Administering the Switch Link Administration Screen

During the NEAX software installation process, the values for the Switch Link Administration screen were administered. You need to change the default settings on this screen. Use the following procedure to change the settings.

1. Login as **craft**.
2. Press **(ENTER)** to accept the AT386 default.

You see the INTUITY Administration menu as shown in Figure 6-1.

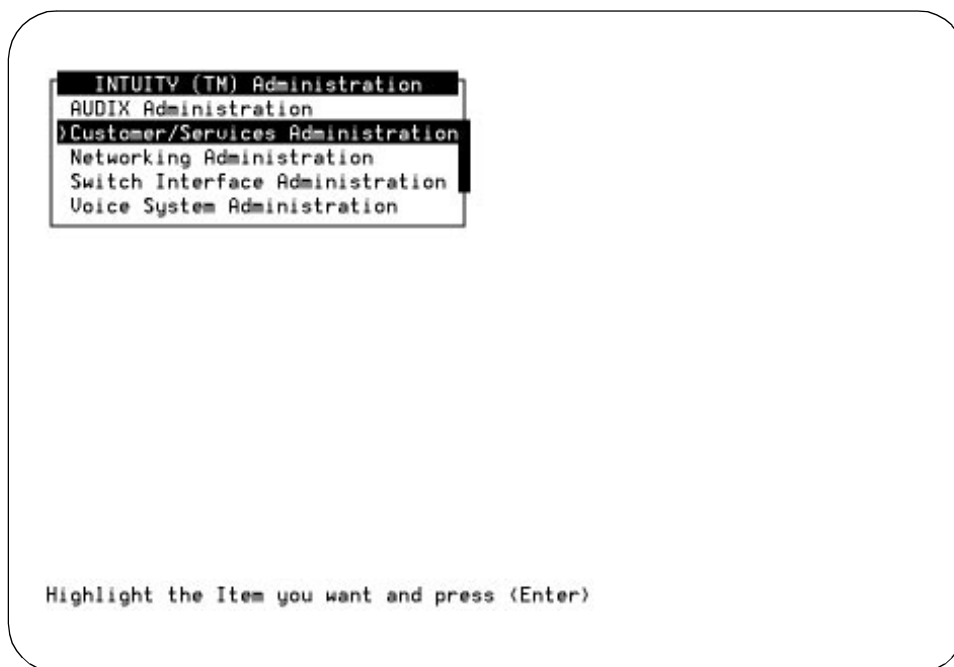

Figure 6-1. INTUITY Main Menu

3. Select **Switch Interface Administration** from the INTUITY Main Menu. After you select the option, you see the Switch Interface Administration menu as shown in Figure 6-2.



Figure 6-2 Switch Interface Administration Menu

4. Select **Switch Link Administration** from the menu. After you select the option, you see the Switch Link Administration screen as shown in Figure 6-3.

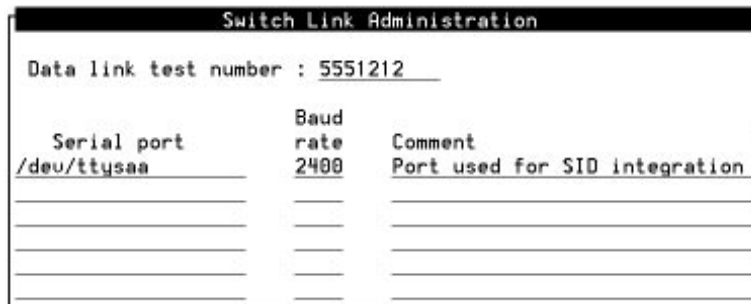

Figure 6-3 Switch Link Administration Screen

5. Use Table 6-1 to enter the correct values in each field on the Switch Link Administration screen.

Table 6-1. Switch Link Administration Screen Entries

Field	Description
Data link test number	<p>Indicates the test number sent to the switch to verify whether the switch is active.</p> <p>Setting: A 7- or 10-digit number that is <i>not</i> an in-service extension number. The number of digits must agree with the setting for the dialstring size set on the SID. Refer to Chapter 3, "Switch Integration Planning", to find the dialstring size.</p>
Serial port	<p>Indicates which port on the multi-port circuit card in the INTUITY system is connected to the integration device.</p> <p>Setting: Press (CHOICES) (F2) to choose from a menu of available ports. Settings are in the format /dev/ttyx, where x is a letter a - h representing a port on the circuit card (from right to left). AT&T recommends that you use /dev/ttysaa as the serial port.</p>
Baud rate	<p>Indicates the rate at which the SID and the INTUITY system communicate.</p> <p>Setting: A baud rate of 1200, 2400, 4800, or 9600. Press (CHOICES) (F2) to choose from a menu of possible settings. This setting must agree the BAUD setting on the SID. AT&T recommends that you use a baud rate of 2400.</p>
Comment	<p>Use the field to enter a comment. Enter a maximum of 30 characters. In your comment, do not use double quotation marks (") or (SHIFT) + backslash (\).</p>

6. Press **SAVE** (F3).

After you press the key, you receive a confirmation message as shown in Figure 6-4. The message tells you that the serial port was registered successfully and that you need to stop and restart the voice system

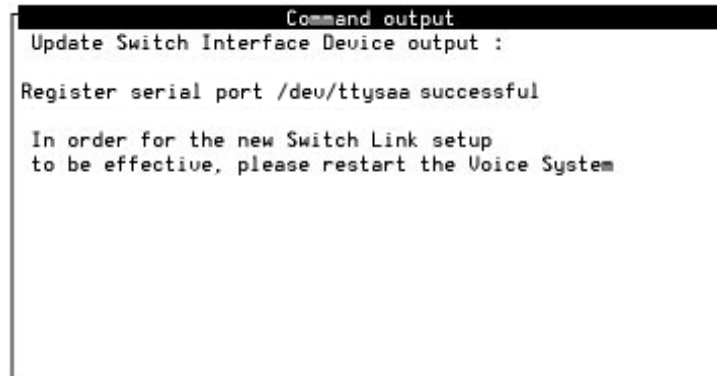

```
Command output
Update Switch Interface Device output :
Register serial port /dev/ttysaa successful

In order for the new Switch Link setup
to be effective, please restart the Voice System
```

Figure 6-4 Switch Link Administration Confirmation Message

7. Press **CANCEL** (F6) until you see the INTUITY Administration menu as shown in the Figure 6-1.
8. Proceed to the next section, "Stopping and Restarting the Voice System".

Stopping and Restarting the Voice System

To execute the changes you made on the Switch Link Administration screen, use the following procedure to stop and restart the voice system.

1. Starting at the INTUITY Administration menu, shown in Figure 6-1., select the following series of menu options:

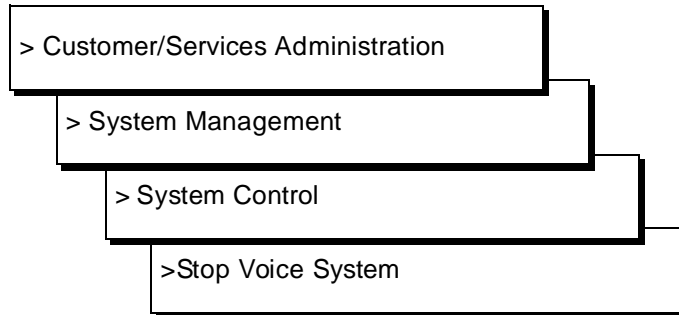

After you select the last option, Stop Voice System, you receive the following message:

```
Enter y to continue, n to quit.
```

2. Enter **y** to begin the process.

Before stopping the voice system, the system pauses until all calls in progress disconnect. During the pause, you see a series of messages.

When all calls have disconnected, you receive the following message:

```
The Voice System has stopped  
Press ENTER to continue...
```

3. Press **(ENTER)**.

The system returns you to the System Control menu.

4. Select Start Voice System from the System Control menu.

After you select the option, you receive a message indicating that the voice system is restarting. When the process finishes, you receive the following messages:

```
Startup of the Voice System is complete  
Press ENTER to continue...
```

5. Press **(ENTER)**.

The system returns you to the System Control menu.

6. Press **(CANCEL)** until you see the INTUITY Administration menu.

Administering the System Translation Screen

Use the following procedure to administer the System Translation screen.

1. Starting at the INTUITY Administration menu, shown in Figure 6-1., select the following series of menu options:

> Switch Interface Administration

> System Translation

After you select the System Translation option, you see the System Translation screen as shown in Figure 6-5.

The screenshot shows the 'System Translation' screen with the following configuration:

```

System Translation
Switch link type: SMSI
Host type: NEAX
Host link ID: 1
Extension length: 4
  
```

Address Ranges:	first	/ last	public network number
1.	0000	/ 9999	0000000
2.		/	
3.		/	
4.		/	
5.		/	
6.		/	
7.		/	
8.		/	

The length of extension is 3 to 7

Figure 6-5. System Translation Screen

2. Use Table 6-2 to enter the correct values in each field on the Switch Link Administration screen.

Table 6-2. System Translation Screen Entries

Field	Description
Switch link type	The field contains the current switch link type. You cannot change this setting.
Host type	The field contains the current host switch type. You cannot change this setting.
Host link ID	The field contains the current host link ID. You cannot change this setting.
Extension length	The field indicates the number of digits allowed for each extension in the address range. Setting: Enter a number from 3 to 10.
Address Ranges: first Address Ranges: last Address Ranges: public network number	The fields indicate the first and last extension number in the address range and the public network number. Setting: Address ranges are obtained from the switch. You can have up to 8 address ranges, one for each public network number. These ranges cannot overlap. The number of digits for the first and last extensions corresponds to the setting in the Extension length field. The number of digits for the public network number must match the dial string on the SID. The public network number must end with the digits of the first extension number. For an example, see Figure 6-5.

3. Press **[SAVE]** (F3) to save your entries on the screen.

After you press the key, you see the Command Output screen as shown in Figure 6-6. The message indicates that the fields were updated successfully.

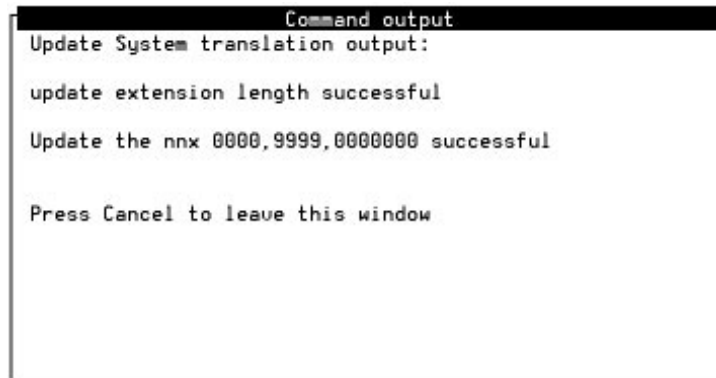

Figure 6-6 Command Output Screen

4. Press **[CANCEL]** (F6) until you return to the INTUITY Administration menu.

You have completed the procedure required on the INTUITY System.

This chapter contains instructions for administering an NEC NEAX 2400 MCI switch to work with an INTUITY System. If you have another type of switch, refer to the documentation provided with that switch or the switch integration package for more information.

The instructions in this chapter only explain the screen fields and information necessary to integrate the NEAX 2400 switch with an INTUITY System. If you require more information for any screens or processes not explained in this chapter, refer to the documentation supplied with your switch for more information.

As you administer the switch, you must perform the following processes:

- Administer analog voice mail ports
- Assign voice mail ports to a UCD group (switch group)
- Configure the Message Center Interface link



NOTE:

This chapter contains administration guidelines for the NEAX 2400 switch with the INTUITY System. The switch administration process should be performed by a trained NEC switch technician.

Administer Analog Voice Mail Ports

Each voice mail port connects to the switch through an analog line. For the integration process to function, you must configure the voice mail port analog lines in the same manner as you configure analog lines for a 2500 telephone set.

After configuring the ports on the switch, you must assign the analog port extension numbers on the SID configuration. You perform the SID processes in Chapter 8, "Switch Integration Device Administration".

**NOTE:**

Automated Attendant may not work properly on the NEAX 2400 with software version 4200 due to limitations in the NEAX 2400 switch.

Use the following instructions to administer the analog lines for the voice mail ports.

1. Log on to the NEAX 2400 Maintenance and Administration Terminal (MAT). For NEAX 2400 MAT logon instructions, contact your system administrator.
2. After you log on to the MAT, you see the 2400 Maintenance Command MENU as shown in Figure 7-1.

```
*** 2400 MAINTENANCE COMMAND MENU ***

1  SYSTEM CONTROL
2  SYSTEM BACKUP
3  MAKE BUSY CONTROL
4  TRAFFIC DATA
5  TEST
6  STATION DATA
7  TRUNK DATA
8  NUMBERING PLAN
9  SERVICE FEATURE DATA (1)
10 SERVICE FEATURE DATA (2)
11 SIGNAL TRANSLATION DATA
12 RESTRICTION DATA
13 INSTALLATION
14 LIST UP

ENTER MENU ITEM NO [ 6 ]
```

Figure 7-1. 2400 Maintenance Command Menu

3. Enter **6** to select the Station Data option. After you select the option, you see the Station Data Commands screen as shown in Figure 7-2.

```
*** STATION DATA COMMANDS ***

1  ASDT:  Assignment of Station Data                [CM01]
2  ASCL:  Assignment of Station Class Data         [CM01]
3  ASTN:  Assignment of Station Number             [CM01]
4  DSTN:  Display of Station Data                  [CM01]
5  AKYD:  Assignment of Key Data for Dterm         [CM01]
6  ASHP:  Assignment of Station Hunting-Pilot     [CM01]
7  RSHP:  Remove Station Hunting-Pilot            [CM01]
8  ASHC:  Assignment of Station Hunting-Circularn [CM01]
9  RSHC:  Remove Station Hunting-Circular         [CM01]
10 ACPG:  Assignment of Call Pickup Group          [CM01]
11 AISA:  Assignment of Individual Speed Calling Entry Area [CM02]
12 APHN:  Assignment of Phantom Station Number    [CM02]
13 ASHU:  Assignment of Station Hunting-UCD       [CM01]
14 RSHU:  Remove Station Hunting-UCD              [CM01]
15 AUOG:  Assignment of UCD Overflow Group        [CM01]

ENTER MENU ITEM NO [ 1 ]
```

Figure 7-2. Station Data Commands Menu

- Enter **1** to select the Assignment of Station Data option and enter station administration information for each voice mail port. After you select the option, you see the screen as shown in Figure 7-3.

Assignment of Station Data

```

TN: 1 STN:
LENS: 000000
TEC: 1 RSC: 0 SFC: 0

TN : Tenant Number
STN : Station Number
LENS: Line Equipment Number (6 Digits)
TEC : Telephone Class (1-31)
      1-DP (10PPS) 22-EMM
      2-PB
      3-DP/PB
      11-VMM/VMZ
      12-Dterm V
      13-Data Terminal via Dterm V
      14-Hot Line
      15-Cas Line
      16-Data Terminal via Data Module
      18-Virtual Line Appearance
      19-TMM
      20-PSM

RSC: Route Restriction Class (0-15)
      for assignment of RSC,ARSC cmnd
SFC: Service Feature Class (0-15)
      for assignment of SFC,ASFC cmnd

```

Figure 7-3. Assignment of Station Data Screen

- In the TN (Tenant Number) field, you see a default value of 1. To select the default value, press **(ENTER)**. The cursor moves to the STN field.
Contact your switch system administrator to determine if this value must be modified.
- At the STN (station) field, enter the number you plan to use as an analog voice mail port extension. After you press **(ENTER)** the cursor moves to the LENS field.
For example, if you want to assign extensions 500, 501, 502, and 503 to a four port system, enter **500** as the first extension.
- In the LENS (Line Equipment Number) field, you see a default value of 00000. Enter the correct LENS. After you press **(ENTER)** the cursor moves to the TEC field.
Contact your switch system administrator for the correct line equipment assignment.
- In the TEC (Telephone Class) field, you see a default value of 1. Enter **3** in the field to permit dial pulse and push button functionality. After you press **(ENTER)** the cursor moves to RSC field.

9. In the RSC (Route Restriction Class) field, you see a default value of 0. Enter the correct RSC. After you press **ENTER** the cursor moves to the SFC field.

Contact your switch system administrator to determine if the default value is correct.

10. In the SFC (Service Feature Class) field, you see a default value of 0. Enter the correct SFC.

Contact your switch system administrator for the correct SFC value.

11. When you finish editing the final field, press **ENTER** to confirm the station administration.

12. When you assign the first station data command for a Line Package, the message `PKG CHECK` appears on the screen.

Check that the correct circuit card is in the correct slot and press **ENTER**. After you press **ENTER** the cursor returns to the first field.

If you continue to assign station data commands to the same Line Package, you receive a `WRT?` message after entering the station information.

Enter **Y** to confirm the information. After you **ENTER** the cursor returns to the first field.

13. Repeat steps 5 through 12 for each analog voice mail port you need to assign. For example, if you have already assigned extension 500 but you still need to assign extensions 501, 502, and 503, return to Step 5 and enter **501** as the second extension. Repeat the process until 502 and 503 have been assigned. When you finish entering the analog voice mail port numbers, press **7** to return to the Station Data Commands menu.

Proceed to the next section, "Assign Voice Mail Extensions to a UCD Group."

Assign Voice Mail Extensions to a UCD Group

After administering the analog voice mail ports, you must assign the ports to a Uniformed Call Distribution (UCD) group or *switch group*. The first extension of a UCD group becomes the forwarding target number for the group. When a subscriber calls INTUITY System, they dial the target number of the UCD group. If the target number is busy, the system *hunts* or moves through the other members of the UCD group until the system finds an open channel and completes the call.

The examples in the previous section assigned extensions 500, 501, 502, and 503 to the analog voice mail ports. 500 was assigned as the first port extension and is the target number.

The NEAX 2400 supports up to seven UCD groups with twenty members in each group. The UCD groups do not automatically transfer calls to each other. To connect the groups, you must use the UCD Overflow feature. Using UCD Overflow, calls flow to the next UCD group if all members of the first UCD group are busy. To support more than 24 ports on the INTUITY System, use UCD Overflow. Refer to the "Setting Up a UCD Overflow Group" section in this chapter for UCD Overflow groups setup instructions.

Use the following instructions to assign voice mail port extensions to a UCD group.

1. At the Station Data Commands Menu shown in Figure 7-2., enter **13** to select the Assignment of Station Hunting-UCD option. After you enter the selection, you see the Assignment Of Station Hunting - UCD screen as shown in Figure 7-4.

```
Assignment of Station Hunting - UCD

TN: 1
STN: 500
CNT: 4 2 STN: 501

TN : Tenant Number
STN: Station Number
CNT: Number of Stations to entered
      (Recommend Max of 20 stations)
ADD: Number of Stations to be added
      (Recommend Max of 20 stations)
*STN: Station Numbers of the Stations
      included in the UCD group
      (* indicates the order of
      a station in the group)
```

Figure 7-4. Assignment of Station Hunting -UCD Screen

2. In the TN field, enter the Tenant Number you assigned to the analog voice mail ports. The system shows a default value of 1 in the field.

After you press **(ENTER)**, the cursor moves to the STN field.

3. In the STN field, enter the number you assigned as the first voice mail port extension. After you enter the station number, the cursor moves to the CNT field.

For example, in the previous section a group of analog voice mail ports was assigned extensions 500, 501, 502, and 503. 500 was the first extension assigned.

4. In the CNT (count) field, enter the number of extensions you need to include in the UCD group. After you enter the count, the cursor moves to the second STN field.

For example, to set up a UCD group using extensions 500, 501, 502, and 503, enter **4**.

5. In the second STN field, enter the second voice mail port station you need to assign to the UCD group.

Using the 500, 501, 502, and 503 example, enter **501** as the second voice mail port station.

6. Repeat Step 5 until you enter all voice mail port extensions in the UCD group. The system continues to ask for voice mail port extensions until you enter the enough stations to match the CNT field.

In the examples above, CNT was set to 4. Extensions 500, 501, 502, and 503 were assigned to the UCD group. 503 is the fourth and last extension.

7. After you enter the last extension for the UCD group, you see the message WRT? on the screen. Enter **Y** to confirm and save the information you entered.
8. Press **[7]** to exit the screen and return to the Station Data Commands menu.

Setting Up a UCD Overflow Group

On the NEAX 2400 switch, you can create a maximum of 7 UCD groups with 20 station extensions in each UCD group. If all the extensions in a UCD group are busy, calls do not automatically transfer to the next group. You must use the UCD Overflow feature to link the groups together. By using the UCD Overflow feature, an incoming call transfers from a busy UCD group to another UCD group. If you plan to use an INTUITY System with more than 24 ports, you must use the UCD overflow feature.

⇒ NOTE:

The NEAX 2400 switch must have software version 4200 or greater to support UCD overflow. If the switch does not contain software version 4200 or greater, the SID only supports 20 voice mail extensions, the maximum allowed in one UCD group.

Use the following instructions to administer UCD Overflow.

1. Use the instructions in the previous section, "Assign Voice Mail Extensions to a UCD Group" to assign all voice mail ports to UCD groups.
For example, if you are setting up an INTUITY System with 24 ports, you could set up 4 UCD groups with 6 ports in each group. Determine the best method for your application.
2. After you create all necessary UCD groups and return to the Station Data Command menu, enter **15** to select the Assignment of UCD Overflow option.

After you select the option, you see the Assignment of Ucd Overflow Group screen as shown in Figure 7-5.

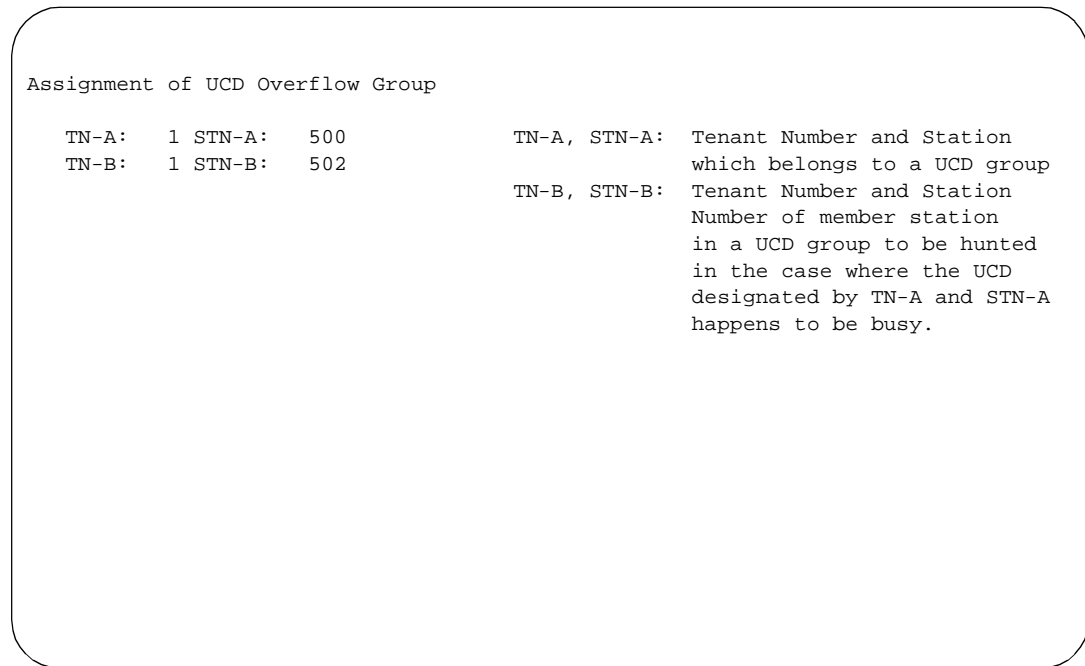

Figure 7-5. Assignment of UCD Overflow Group Screen

3. In the TN-A field, enter the Tenant Number you assigned to the first UCD group you created. After you press **ENTER**, the cursor moves to the STN-A field.
4. In the STN-A field, enter the target number of the first UCD group you created. After you press **ENTER**, the cursor moves to the TN-B field.

For example, if you create two UCD groups with extensions 500 and 501 in the first group and extensions 502 and 503 in the second group, the target number for the first UCD group is 500.

5. In the TN-B field, enter the Tenant Number you assigned to the UCD group you want the system to transfer to when the first UCD group is busy. Figure 7-5. use 1.
6. In the STN-B field, enter the target number of the UCD group you want the system to transfer to when the first UCD group is busy.

Figure 7-5. uses 502 as the target number of the second group.

In the example, when all stations in UCD group 500 are busy, voice messaging traffic automatically *overflows* or transfers to the target number of the second UCD group, 502. You can link more than two UCD groups. If you do need to link more than two UCD group, assign overflow for the target number of the second UCD group to the target number of the third UCD group. You may assign overflow to as many as 7 groups of 20 stations each.

Configuring the Message Center Interface Link

Voice messaging information travels from the switch to the SID through the Message Center Interface (MCI) link. For the MCI link to function properly, you must configure the MCI data link. During the process you perform the following actions:

- Administer the Message Waiting Lamp
- Assign a port for the MCI link
- Define the MCI port as a terminal

Administer the Message Waiting Lamp

You must administer the switch to assign Message Waiting Lamp (MWL) control to the MCI link. Use the following instructions to administer the MCI link MWL parameters.



NOTE:

Do not change any information on any screen until you contact your NEAX 2400 switch administrator. Few switches are identically configured. The instructions in this section provide the minimum requirements for the MCI integration to function with the SID. If you need more information on configuring the switch, contact your switch administrator or consult the documentation supplied with the switch.

1. At the 2400 Maintenance Command menu, shown in Figure 7-1., enter **13** to select the Installation option. After you select the option, you see the Installation Commands menu as shown in Figure 7-6.

```
***      INSTALLATION COMMANDS      ***

1  ASYD:  Assignment of System Data           [CM03]
2  AUNT:  Assignment of Unit Data           [CM03]
3  ASTD:  Assignment of State Translation Data [CM03]
4  ATCC:  Assignment Terminal Configuration Command [CM03]
5  ASMD:  Assignment Service Module Data     [CM03]
6  MMNF:  Make Menu File                    [CM02]

      ENTER MENU ITEM NO [ 1 ]
```

Figure 7-6. Installation Commands Menu

2. Enter **1** to select the System Data option. After you press **ENTER**, you see the Assignment Of Station Data screen as shown in Figure 7-7.

Assignment of System Data

```
SYS: 1
INDEX: 28      DATA: 20

SYS : System Data Items
      1-System Data 1
      2-System Data 2
      3-System Data 3
TN   : Tenant Number
INDEX: System Data Index
      System   Index
      1       0-255
      2       0-15
      3       0-31
DATA : System Data (Hexa-decimal)
```

Figure 7-7. Assignment of System Data Screen

3. Enter **1** in the SYS field.

You can select three types of switch system parameters. Each type has a different effect on the switch, as shown in the following list.

- Type 1 — parameters that effect the entire system
- Type 2 — parameters that effect specific system tenants
- Type 3 — parameters that effect the system timing

MWL control effects the entire system.

4. Enter **28** in the INDEX field.

System data (SYS) 1, which you specified in Step 3, uses 255 indexes to control a variety of system parameters. Index 28 controls MWLs.

5. Enter **20** in the DATA field.

The value of 20 works with the information you entered in SYS and INDEX to set MWL control to the MCI link.

6. After entering the information, press **Q** to exit the screen and return to the Installation Commands menu as shown in Figure 7-6.

If you need more information for any of the screen fields or processes described in this section, contact your switch administrator or consult the documentation supplied with your switch.

Assign a Port for the Message Center Interface Link

Use the instructions in this section to assign a port for the MCI link. Assigning a port tells the switch the proper port to send information to the SID through the MCI link.

1. At the Installation Commands menu, shown in Figure 7-6., enter **1** to select the System Data option. After you press **(ENTER)** you see the Assignment Of Station Data screen as shown in Figure 7-8.

```

Assignment of System Data

SYS: 1
INDEX: 29   DATA: 02

SYS : System Data Items
      1-System Data 1
      2-System Data 2
      3-System Data 3
TN   : Tenant Number
INDEX: System Data Index
      System   Index
      1       0-255
      2       0-15
      3       0-31
DATA : System Data (Hexa-decimal)

```

Figure 7-8. Assignment of System Data Screen

2. Enter **1** in the SYS field to tell the switch that the parameter changes effect the entire system.
3. Enter **29** in the INDEX field.

System data (SYS) 1 uses 255 indexes to control a variety of system parameters. Index 29 controls the port assignment for the MCI link.

4. Enter the port assignment number in the DATA field. Use Table 7-1 to determine the port assignment for the MCI link.

To use the chart, find the port number you want to use under the Port heading. When you find the port number, find the Data value in the Data column across from the port number. One port is reserved for the MAT. The example in Figure 7-8. uses port 1 (Data 02).

Table 7-1. Port Assignment Data Field Values

Port	Data	Bit
MAT Terminal		
1	02	1
2	04	2
3	08	3
4	20	4
5	40	5

5. After entering the information, press **7** to exit the screen and return to the Installation Commands menu as shown in Figure 7-6.

If you need more information for any of the screen fields or processes used in this section, contact your switch administrator or consult the documentation supplied with your switch.

Define the Port as a Terminal

You must now designate that the port assigned to the MCI link is a terminal or two-way communication port. If you do not perform this step, the switch uses the port as a printer or one-way communication port.

Use the following instructions to define the MCI port type.

1. At the Installation Commands menu, shown in Figure 7-6., enter **1** to select the System Data option. After you press **(ENTER)**, you see the Assignment of Station Data screen as shown in Figure 7-9.

```
Assignment of System Data
```

```
SYS: 1  
INDEX: 117 DATA: 01
```

```
SYS : System Data Items  
      1-System Data 1  
      2-System Data 2  
      3-System Data 3  
TN   : Tenant Number  
INDEX: System Data Index  
      System  Index  
      1      0-255  
      2      0-15  
      3      0-31  
DATA : System Data (Hexa-decimal)
```

Figure 7-9. Assignment of System Data

2. Enter **1** in the SYS field to tell the switch that the parameter changes effect the entire system.
3. Enter the index number in the INDEX field that corresponds to the port number you entered in the previous section, "Assign a Port for the Message Center Interface Link". Use Table 7-2 to determine the index number for the port.

Under the Port heading, find the port number you assigned to the MCI link in the "Assign a Port for the Message Center Interface Link" section. When you find the port number, locate the index value in the Index column across from the port number. Figure 7-9. uses an index value of 117, showing that the MCI link was assigned port number 1.

Table 7-2. Index Assignment Values

Port	Index	Data
MAT Terminal		
1	117	01
2	118	01
3	119	01
4	120	01
5	121	01

4. Enter **1** in the DATA field. The number tells the switch that the port is a terminal and allows two-way communication.

Assign the MCI Link to a UCD Group

You must instruct the switch that the MCI link is associated with the UCD group you created in the previous section. If you do not perform this step, the switch does not communicate through the MCI link.

Use the following instructions to configure the UCD group with the MCI link.

1. At the INSTALLATION COMMANDS menu, shown in Figure 7-6., enter **1** to select the System Data option. After you press **(ENTER)**, you see the ASSIGNMENT OF STATION DATA screen as shown in Figure 7-10.

```

Assignment of System Data

SYS: 2      TN: 1
INDEX: 6    DATA: 01

SYS : System Data Items
      1-System Data 1
      2-System Data 2
      3-System Data 3
TN   : Tenant Number
INDEX: System Data Index
      System  Index
      1      0-255
      2      0-15
      3      0-31
DATA : System Data (Hexa-decimal)
    
```

Figure 7-10. Assignment of System Data

2. Enter **2** in the SYS field to tell the switch to associate the MCI link with a UCD group on a tenant by tenant basis.
3. Enter **1** in the TN field. You must use the same tenant value that you used to create the analog stations and UCD groups.
4. Enter **6** in the INDEX field. The value contains fields that allow the system to associate the MCI link with the UCD group or groups.

5. Look at the value in the DATA field and write the value on the following line

Current DATA value: _____



NOTE:

Do not change the value in the DATA field until you consult with your switch administrator. This index contains other fields that control features not related to MCI.

6. Enter **01** in the DATA field.

You have completed the NEAX 2400 MCI switch administration. Proceed to Chapter 8, "Switch Integration Device Administration", to configure the switch integration device.

Switch Integration Device Administration

8

The instructions in this chapter explain how to configure the SID to integrate with an NEAX 2400 MCI switch and an INTUITY System. The installation technician administers the SID based on NEAX switch administration information provided by the customer. As you administer the SID configuration, you must perform the following tasks:

- Administer the basic parameters
 - Number of voice mail ports
 - Message desk number
 - CPID pad string
 - MWI pad string
 - MWI feature
- Administer the extensions and logical terminal numbers
- Save and start the configuration
- Administer the serial data links
- Set the security level
- Change the system parameters
 - Set the date and time
 - Adjust the LCD contrast

Administer the Basic Parameters

In Chapter 3, "Switch Integration Planning", you completed switch integration planning worksheets and determined the values for each of the basic parameters. If you did not complete the worksheets, turn to Chapter 3 and complete them now before you proceed with the instructions in this chapter.

After you complete the worksheets in Chapter 3, continue with the instructions on the next page to configure the basic parameters.

1. To access the basic parameters edit forms, press **(FUNC)** on the SID keypad.

After you press the key, you see the MCI MAIN MENU as shown in the following example:

NEC	1-View	2-Utills	3-System
	4-Setup	5-Logs	

2. To set up the basic parameters for the MCI data link, press **(4)** on the SID keypad to select the SETUP option.

After you press the key, you see the SETUP menu as shown in the following example:

SETUP	1-Params	2-Ports	3-Clear
	4-Advanced		

3. Press **(1)** on the SID keypad to access the first in a series of eight PARAMS edit forms as shown in the following example:

SETUP	Number of Ports	140
-------	-----------------	-----

4. Enter the number of analog voice mail ports from worksheet A that the SID must support for the INTUITY System.
5. Press **(▼)** to confirm the number and move to the next basic parameter edit form, the MSG DESK NUMBER form, as shown in the following example:

SETUP	Msg Desk Number :	001
-------	-------------------	-----

6. Enter the three-digit message desk number from worksheet A in Chapter 3.
7. Press **(▼)** to confirm the number and move to the next basic parameter edit form, the CPID PAD STRING form, as shown in the following example:

SETUP	CPID Pad String:	0000000
-------	------------------	---------

8. Press **(▼)** to accept the default CPID Pad String number of 0000000 and move to the next basic parameter edit form, the MWI PAD STRING form, as shown in the following example:

SETUP	MWI Pad String:	0000000
-------	-----------------	---------

9. Press **(▼)** to accept the default MWI pad string number of 0000000 and move to the next basic parameter edit form, the MWI FEATURE form, as shown in the following example:

SETUP	MWI Feature:	ENABLE
<- ->1		

10. Set the value for the message waiting feature as listed on worksheet A in Chapter 2.
The SID defaults to Enable. If you want to turn off the feature, press the left or right arrow key to change the value to Disable.
11. Press **(ENTER)** to confirm the information.

You have finished entering the MCI basic parameter information. To return to the MCI MAIN MENU, press **(FUNC)**.

Proceed to the “Assign Extensions and LTNs” section on the next page to continue the SID configuration.

Assign Extensions and LTNs

As you assign extensions and LTNs, you associate an LTN (Centrex LTN) with each analog extension number used by an INTUITY System. For each extension, you must assign the same LTN to the extension as the INTUITY System assigns to the extension. If you do not assign the same LTN, the SID does not integrate calls properly. Read the section on the AutoFill feature before you assign extensions and LTNs.

Use the following instructions to assign extensions and LTNs.

1. To access the extension and LTN edit forms, press **(FUNC)** on the SID keypad.

After you press the key, you see the **SETUP** menu as shown in the following example:

SETUP	1-Params	2-Ports	3-Clear
	4-Advanced		

2. Press **(2)** to select Ports and access the chain of forms used to enter and edit extension and LTN information.

After you press the key, you see the **VM PORT** form as shown in the following example:

VM Port 1	LTN:	0001
	Extension:	-----

The **VM PORT0** form and the next series of forms link together. The number of **VM PORT0** forms linked together depends on the number you entered on the **NUMBER OF VOICE MAIL PORTS** form in the “Basic Parameters” section. If you entered 4, for example, the SID would link 4 **VM PORT** forms together.

3. If you do not want to use the default LTN, use the keypad to type an LTN over the default. The sample screen uses an LTN of 0001.

In Chapter 3, you completed worksheet B, “Extension/LTN Plan.” Use worksheet B as you enter LTNs and extensions.

4. Press **(ENTER)** to confirm the LTN. The cursor moves to the Extension field.

- Use the keypad to type an extension for the LTN.

Use worksheet B as you enter LTNs and extensions.

⇒ NOTE:

Each VM PORT0 form contains a default LTN, starting with 0001. If you want to use the default, press **(ENTER)** to select the default and move the cursor to the Extension field. Enter the extension number for the LTN. Press **(ENTER)** to confirm the number then press **(▼)** to move to the next form.

- After you enter the extension, press **(▼)** to move to the next VM PORT form as shown in the following example:

VM Port 2	LTN:	0002
	Extension:	211__

In the example, notice that the LTN default automatically increased by one to 0002. You also can set the extension field to automatically increase by using the Autofill feature. For more information on the Autofill feature, refer to the section titled "Using AutoFill."

- Repeat steps 4 through 6 until you have entered an LTN and an extension for each analog voice mail port.
- After you have entered valid LTNs and extensions for all forms, press **(FUNC)** to return to the MCI MAIN MENU.

Using AutoFill

If you use consecutive extension numbers, numbers that increase by one, the SID provides an *AutoFill* feature that automates the entry process. Using AutoFill, you enter the first extension number on the first VM PORT form. As you move to the next VM PORT form, AutoFill adds one to the extension you entered and places the number in the Extension field.

Example: At the first VM PORT form for a four port configuration, you enter **210** in the Extension field. After selecting AutoFill, you move to the next VM PORT form. The SID adds one to the extension and places 211 in the Extension field. On the next form, the SID places 212 in the field and 213 in the extension number field on the fourth (last) form.

Follow the instructions on the next page to use the AutoFill feature.

1. After accessing the first VM PORT form as instructed in the previous section of this document, enter an extension number in the Extension field. The following example uses 210 as the first extension number:

VM Port 1	LTN:	0001
	Extension:	210__

2. Position the cursor on the extension number you entered.
3. Press the MODE key for editor help.

After you press the key, you see an editor help screen as shown in the following example:

EDIT	1-Overtyp	2-Insert	3-Clear
	4-Undo	5-AutoFill	

4. Press **(5)** to activate the AutoFill option. The SID now uses the number you entered in the first extension field as the base number, adds one to the number for each form, and places the new number in the extension fields of the remaining forms. In the example, 210 was used as the first extension number. AutoFill automatically places the extension numbers 211, 212, and 213 into the second, third and fourth forms and returns you to the VM PORT form.

If only part of your extensions are numbered consecutively, you can still use the AutoFill feature.

Example: You have a 12 port system. The five extension numbers from 100 to 104 are consecutive. After extension 104, your extensions skip to 200 and continue consecutively to 206. To use the AutoFill feature, follow the regular Autofill instructions for numbers 100 to 104. When you reach the form that contains extension 105, move the cursor to the Extension field. Enter 200 in the field and turn on AutoFill again. The SID places extensions 201 to 206 in the remaining 6 edit forms.

You also can use AutoFill for LTN data. If you need to start your LTNs at 0010, for example, enter **0010** into the first form. Turn on AutoFill. AutoFill enters 0011 and up in the LTN fields of the remaining forms.

Continue to the procedure in the next section, "Saving and Starting the Configuration."

Saving and Starting the Configuration

After you administer the basic parameters and assign extensions and LTNs, you must save the configuration. You also can start the integration at this point, although you should perform the tasks in the “Administer Serial Data Links” section to check the default settings for the MCI and SMDI communication links.

Use the following instructions to save the configuration and start the system.

1. Press **FUNC** on the SID keypad.

After you press the key, you see the SETUP menu.

2. Press **FUNC** again to return to the MAIN MENU.

After you press the key and return to the MAIN MENU, the SID checks the current configuration against the information you entered. Because you made changes to the configuration, the SID places the following prompt on the screen:

```
SAVE EDITS?           1-Yes           2-No
```

3. Press **1** to select Yes and save your configuration changes.

After you press the key, the SID saves the information you entered and shows the following message on the screen:

```
Setup Saved...
```

4. After a short pause, the SID places another prompt on the screen as shown below:

```
START SYSTEM?       1-Yes           2-No
```

5. If you want to start the integration, press **1** to select Yes.

If you are not ready to start the integration, press **2** to select NO.

After you press **1** you see the Restarting System... message on the screen. The SID pauses for a few seconds then starts the integration. When the integration

starts, you see the SMDI VIEW MODE screen as shown in the following diagram. below:

```
SMDI Idle
```

When the SID receives calls, the screen changes to show the SMDI packet being sent to the INTUITY System.

The screen appears similar to the following example:

```
SMDI MWI:      OOP:MWI 0000202! .
CPID:         ..MD0010001D 0000201 ...
```

For more information on view modes, refer to Appendix B, "Using Views During Integration", in this document. Continue to the procedure in the next section, "Administer Serial Data Links."

Administer Serial Data Links

The SID assigns default configurations to both the MCI and SMDI communication ports. You need to check the SID to make sure the defaults are set correctly and match the requirements of your integration. The SID sets the defaults shown in Table 8-1 for the serial data links.

Table 8-1. Serial Data Link Default Values

Link Type	Settings
SMDI:	1200 baud 7 data bits 1 stop bit EVEN parity
MCI:	1200 baud 7 data bits 1 stop bit EVEN parity

Use the following instructions to check or correct the default settings.

1. To access the edit forms used to change the serial data links, press **(FUNC)** to access the MCI MAIN MENU.

After you press the key, you see the MCI MAIN MENU as shown in the following example:

NEC	1-View	2-Utils	3-System
	4-Setup	5-Logs	

2. Select Utils from the menu by pressing **(2)** on the SID keypad.

After you press the key, you see the UTILS menu as shown in the following example:

UTILS	1-Login	2-Date/Time	3-Serial
-------	---------	-------------	----------

3. Press **(3)** on the SID keypad to access the SERIAL menu.

After you press the key you see the SERIAL menu as shown in the following example:

SERIAL	1-Centrex	2-MCI
--------	-----------	-------

4. Enter the menu item number of the serial data link you need to edit.

When you select MCI or Centrex (SMDI) from the menu, you access four edit forms. Use the forms to set the serial data to the values your application requires. For example, press **(2)** on the keypad.

⇒ NOTE:

Both the MCI and Centrex edit forms appear the same, except for the edit form name. The MCI forms were chosen only as an example in this document. You can select either serial data link or both. You also can use the default values, as described earlier in this section.

5. After you press the key, you see the BAUD RATE edit form as shown in the following example:

MCI	Baud Rate:	1200
<-	->1	

- To change the default value shown, press the left or right arrow key to toggle through the optional values. The value you set for the baud rate must equal the value set for the SID to the INTUITY System communication link baud rate. Do not set two different values for these links. Stop pressing the arrow keys when you find the value you want to use.

**NOTE:**

In Chapter 3 you completed worksheet A which contained lines for the MCI baud rate and the SMDI baud rate. Refer to the worksheet to review the baud rates you selected. For the INTUITY system, the baud must be set to 2400.

- After you select a baud rate, press to confirm your choice and move to the next form.

After you press enter, you see the PARITY form as shown in the following example:

MCI	Parity:	EVEN
<-	->1	

- To change the default parity value shown in the field, press the left or right arrow key to toggle through the optional values. Stop pressing the arrow keys when you find the parity value you want to use.
- After you select a parity, press to confirm your choice and move to the next form.

After you press enter, you see the BYTE LENGTH form as shown in the following example:

MCI	Byte Length:	7 Bits
<-	->1	

- To change the default byte length shown in the field, press the left or right arrow key to toggle through the optional values. Stop pressing the arrow keys when you find the byte length you want to use.
- After you select a byte length, press to confirm your choice and move to the last form.

After you press the key, you see the STOP BITS form as shown in the following example:

MCI	Stop Bits:	1
<-	->1	

12. To change the default stop bit value shown in the field, press the left or right arrow key to toggle through the optional values. Stop pressing the arrow keys when you find the stop bit value you want to use.
13. After you select a stop bit value, press **(ENTER)** to confirm your choice.
14. Press **(FUNC)** to return to the MCI MAIN MENU. If you need to reconfigure the SMDI data link, return to step 2.

You have completed the MCI or SMDI configuration setup. The SID automatically accepts and saves any information you change. Continue to the procedure in the next section, "Changing System Parameters."

Changing System Parameters

The SID provides access to some adjustable global system parameters. You can change the following two parameters:

- Time and date
- LCD contrast setting

Use the instructions in this section to change the two system parameters.

Setting the Date and Time

Set the date and time when you install your SID system so error log messages are properly timestamped. Although the date and time are set at the factory, you may need to change the time to correct differences in time zones. Follow the instructions below to set the date and time.

1. Press **(FUNC)** to access the MCI MAIN MENU.
2. Press **(2)** to access the UTILITIES menu.
3. Press **(2)** to access the DATE AND TIME form.

After you press the key, you see the DT/TM form as shown in the following example. The cursor appears in the month field.

DT/TM	Date :	11/18/91
	Time	15:35:00

4. Place the cursor on the Date field.
5. Enter the correct date in the format MM/DD/YY (month/day/year) by pressing **(ENTER)** and typing the month, day, and year in each part of the date field. If the date is correct, do not change the information and proceed to the next step.

6. After you enter the year in the last date field, press **(ENTER)** to confirm the date and move the cursor to the Time field.
7. Enter the correct time in the format HH:MM:SS (hour:minute:second) by pressing **(ENTER)** and typing the hour, minutes, and seconds in each part of the time field. If the time shown is correct, proceed to the next step.
8. Press **(FUNC)** to return to the MCI MAIN MENU.

The SID accepts and uses the information. You do not have to save the information or restart the integration. Continue to the next section, "Adjusting the LCD Contrast."

Adjusting the LCD Contrast

The LCD has a contrast adjustment edit form that you use to adjust the screen. Follow the instructions below to adjust the LCD contrast.



1. Press **(FUNC)** to access the MCI MAIN MENU.
2. Press **(3)** to access the SYSTEM TOOLS menu.

After you press the key, you see the SYSTEM TOOLS menu as shown in the following example:

SYSTEM	1-Info	2-Contrast	3-Start
	4-Stop	5-Reboot	

3. Press **(2)** to access the CONTRAST form.

After you press the key, you see the CONTRAST form as shown in the following example:

CONTRAST 50% <- ->		
-----------------------	---	--

4. Change the setting by pressing the right and left arrow keys. As you press the arrow keys, the display changes.
5. Stop pressing the arrow keys when you adjust the LCD to a comfortable level.
6. Press **(FUNC)** to return to the MCI MAIN MENU.

Continue to the procedure in the next section, "Special Processing for Message Waiting Lamps."

Special Processing for Message Waiting Lamps



NOTE:

The instructions in this section only can be performed by trained AT&T software specialists.

The SID can buffer up to 4000 individual message waiting transactions and wait for small intervals of time to perform the transactions. Incoming calls receive a higher priority. If you use the Metrics View and discover that the SID is holding large numbers of MWL transactions you can perform one of the following actions.

- You can alter the MWL Interleave Factor. By decreasing the MWL Interleave Factor, the speed of transactions out of the queue increases, but call processing speed decreases. See the documentation supplied with your switch for more information.
- You can use the SID's enhanced MWL processing. Continue with the instructions in this section to use the enhanced MWL processing.

On a very active voice mail system, a subscriber can receive multiple messages in a very short period of time. Each message turns on the MWL which quickly increases the size of the buffer. Enhanced MWL handling insures that only a single entry in the MWL queue is used for a specific subscriber, which reduces the queue loading.

For example, an INTUITY System receives three MWL requests in rapid succession. The first turns on John Smith's lamp, the second turns off J. Doe's lamp, and the third turns on John Smith's lamp. Each is a valid request and each is queued for processing. John Smith's lamp does not need to be lit twice, however.

Enhanced MWL processing defaults to disabled and the SID queues and processes all MWL requests in sequence. In the example above, all three requests would be processed and John Smith's lamp would be lit twice in quick succession.

If you enable enhanced MWL processing, the MWL command for John Smith is sent to the queue as a normal request. Any future requests for John Smith overwrite the first, insuring that John's lamp is only turned on once and set to the state that the voice messaging system expects at the time of the operation. When enhanced MWL processing is activated, the number of requests made by the INTUITY System can be considerably larger than the actual number of transactions undertaken by the SID.

Use the instructions on the next page to enable the enhanced MWL processing feature.

1. Press **[FUNC]** to access the SETUP menu as shown in the following example:

```
SETUP          1-Params      2-Ports      3-Clear
                4-Advanced
```

2. Press **[4]** to select the Advanced option. After you press the key, you see the ADVNC screen as shown in the following example:

```
ADVNC          MWI Compress:      OFF
<-  ->1
```

3. Use the left and right arrow keys to turn MWL Enhanced processing to ON.

After you set enable MWL Enhanced processing, the SID automatically begins to use the feature.

You do not have to save or restart the configuration. Continue to the procedure in the next section, "Setting a Security Level."

Setting a Security Level

The various features and functions of the SID are available only at specific security levels. The list below shows each security level and the options available to that level.

- Access Level 0 — The lowest security level. The only options available to level 0 are the ability to view integration activities, change the contrast on the LCD display, see the software version level, and log in to other access levels. The SID normally operates at level 0 and you do not need a password to access level 0.
- Access Level 1 — The second security level. Level 1 allows you to access all level 0 features and all of the tools needed to administer the system. The password for this level is the last five digits of your serial number.
- Access Level 2 — The highest level of security. Level 2 allows you to access all level 0 and level 1 features and several special diagnostic tools available only to trained personnel. Only AT&T authorized personnel can access this level, either on-site or remotely, to perform testing and diagnostics on the SID. The password for this level is only given to authorized personnel.

The factory sets the SID to access level 1. When you first power on the SID, the unit accesses the SETUP menu and allows you to access all tools required to perform the administration tasks. You can select a security level for the SID and make the security level part of the configuration. AT&T recommends that you select security level 0 as the normal operating mode for the SID. Users only can access level 0 features, which reduces the risk of tampering by unauthorized users.

Use the following instructions to set the security level on the SID.

1. Press **(FUNC)** to access the MAIN menu as shown in the following example:

NEC	1-View	2-Utils	3-System
	4-Setup	5-Logs	

2. Press **(2)** to select the UTILS menu as shown in the following example:

UTILS	1-Login	2-Date/Time	3-Serial
-------	---------	-------------	----------

3. Press **(1)** to select the LOGIN form as shown in the following example:

LOGIN	Access Level:	1
<- ->0	Password	

4. Press the arrow (<- ->) keys to change the access level to 0.
5. Press **(ENTER)** to save the change. The SID immediately updates your security level.

To log in to level 1, use the instructions above to access the LOGIN form. Use the arrow keys to set Access Level to 1. The SID now asks you for a password. Type in the level 1 password and press **(ENTER)**.

⇒ NOTE:

As you type the password, you do not see the letters on the screen.

When you complete the instructions in this chapter, proceed to Chapter 9, "Acceptance Tests", in this document.

Acceptance Tests

9

Do not perform any tasks in this chapter until you complete the required tasks in the following appropriate documents:

- *Intuity MAP/5 Hardware Installation, 585-310-137*
- *Intuity MAP/40 Hardware Installation, 585-310-138*
- *Intuity MAP/100 Hardware Installation, 585-310-139*
- *Intuity Software Installation, 585-310-140*

The installation documents explain when you must use the instructions in this chapter. If you have not performed the tasks in the installation documents, complete the tasks now. This chapter explains how to administer the switch to perform acceptance tests for the Intuity system.

As explained in *INTUITY New System Planning*, 585-310-603, two test subscribers should have been administered on the switch for acceptance tests. Acceptance tests begin after you complete initial administration and administer two test subscribers on the INTUITY System. This chapter explains how to administer two test subscribers on the NEAX 2400 MCI switch for performing acceptance tests. If you have another type of switch, refer to the documentation provided with that switch or the switch integration package for more information.



NOTE:

The MCI link controls the message waiting indication. Four- and eight-button Dterm telephones have a message waiting lamp. On a 16-button Dterm telephone, you see ∇ MM on the display to tell you that you have voice mail. Analog (2500) sets require neon lamps and the switch must have an auxiliary 90V power supply to operate the lamps.

Continue with the procedures in this chapter to administer the switch for acceptance tests. Before you proceed, though, select two test extensions to use for acceptance tests. Use the test subscribers listed in *Intuity New System Planning*, 585-310-603.

Administer the Test Subscribers

By forwarding a subscriber extension to the main extension of the Uniformed Caller Distribution (UCD) group, the switch sends call information over the MCI link to the SID. The SID converts and sends the information to the INTUITY System. A call forwarded from the switch to the application is called an *integrated* call. You can set the following call forwarding conditions:

- Forward subscribers for ring-no-answer
- Forward subscribers for busy conditions
- Forward subscribers for all calls

For acceptance tests, activate all three conditions.

Task 1: Forward Calls for Ring-No-Answer

Ring-No-Answer (RNA) refers to an unanswered call. After a specific length of time, set on the switch, without the call being answered, the call transfers to the UCD group assigned to the INTUITY System.



NOTE:

The test subscriber's service feature class must contain call forward RNA SFI=8. Dterm sets may have a function key for forward on busy (FKY=22).

For a station transferred blindly to a ring-no-answer station, the recall timer takes priority over forward RNA. A call transferred to a busy extension transfers back to the station that initiated the transfer.

Use the following instructions to forward an RNA call for the test subscribers.

1. Using the phone of the first test subscriber, lift the handset and listen for the dial tone.
2. Dial the access code or press the function key for forward RNA.

After you perform the action, you hear a second dial tone.

⇒ NOTE:

If you do not know the access code or the function key for forward RNA, contact your switch administrator. The switch administrator sets the codes and function keys during the initial setup of the switch.

3. Dial the main extension of the UCD group to forward RNA calls to integrated voice mail. You created the UCD main extension during the switch administration process in Chapter , "NEAX 2400 Switch Administration", of this document.

After you complete the process, process to the next task, "Forward Calls for Busy Conditions."

Task 2: Forward Calls for Busy Conditions

Use this feature to forward a call when the extension is busy. When the switch attempts to send a call and finds a busy extension, the switch transfers the call to the INTUITY System.

⇒ NOTE:

The subscriber's service feature class must contain call forward busy SFI=9. Dterm sets may have a function key for forward on busy (FKY=1).

Use the following instructions to forward a busy call for acceptance tests.

1. Using the phone of the first test subscriber, lift the handset and listen for the dial tone.
2. Dial the access code or press the function key for forward on busy.

After you perform the action you hear a second dial tone.

⇒ NOTE:

If you do not know the access code or the function key for forward on busy, contact your switch administrator. The switch administrator sets the codes and function keys during the initial setup of the switch.

3. Dial the main extension of the UCD group to forward busy calls to integrated voice mail. You created the UCD main extension during the switch administration process in Chapter 7 of this document.

Task 3: Forward Subscribers for All Calls

Use this feature to forward all calls to the INTUITY System. The switch automatically transfers the call to the UCD group administered for the INTUITY System.



NOTE:

The subscriber's service feature class must contain call forward RNA SFI=7. Dterm sets may have a function key for forward on busy (FKY=2).

Use the following instructions to forward all calls for acceptance tests.

1. Using the phone of the first test subscriber, lift the handset and listen for the dial tone.
2. Dial the access code or press the function key for forward all calls.

After you perform the action you hear a second dial tone.



NOTE:

If you do not know the access code or the function key for forward all calls, contact your switch administrator. The switch administrator sets the codes and function keys during the initial setup of the switch.

3. Dial the main extension of the UCD group to forward all calls to integrated voice mail. You created the UCD main extension during the switch administration process in Chapter 7 of this document.

Repeat Task 1, 2, and 3 for the second test subscriber. After you administer all features for both test subscribers, return to the "Acceptance Test" chapter in *INTUITY Software Installation*, 585-310-140, and complete the acceptance test procedures.

Do not perform any tasks in this chapter until you complete the necessary cut-to-service tasks in the *Cut-to-Service* chapter of *INTUITY System Software Installation*, 585-310-140. The installation document explains when you must use the instructions in this chapter. If you have not performed the tasks in the installation document, complete the tasks now.

This chapter explains how to administer the switch for the INTUITY system cut-to-service process. Cutting over an INTUITY system requires you to change the coverage path used by all subscribers. All INTUITY system initial administration, switch administration, and acceptance tests must be completed before you cut the system into service. To perform the cut-to-service process, you must perform the following

Cutting to service on the NEAX 2400 MCI switch is a phone-based task. A procedure must be performed at each subscriber telephone to administer the extension on the switch. Although each telephone only requires administration once, the process may require a large amount of time if you have a large subscriber base.

Instead of having the system administrator perform the subscriber telephone tasks, have each subscriber perform the task. Use an *In-service* letter to provide instructions to the user for performing the tasks. Use the instructions in this chapter to write the user instructions. Determine the best cut-to-service strategy in advance and plan a time to administer the subscriber extensions.

**NOTE:**

When you cut the subscribers into service, all subscribers receive INTUITY System service. You need to prepare the subscribers and train the system attendants before you cut to service.

Administer the Subscriber Telephones

By forwarding a subscriber extension to the main extension of the UCD group, the switch sends call information over the MCI link to the SID. The SID converts the information to SMDI protocol and sends the information to the INTUITY System. A call forwarded from the switch to an INTUITY System is called an *integrated* call.

You can set three different call forwarding conditions, listed below, depending on your needs or the needs of the individual subscribers.

- Forward subscribers for ring-no-answer
- Forward subscribers for busy conditions
- Forward subscribers for all calls

Task 1: Forward Subscribers for Ring-No-Answer

Ring-No-Answer (RNA) refers to an unanswered call. After a specific number of rings without the call being answered, the call transfers to the UCD group assigned to the INTUITY System.



NOTE:

The subscriber's service feature class must contain call forward RNA SFI=8. Dterm sets may have a function key for forward RNA (FKY=22).

For a station transferred blindly to a ring-no-answer station, the recall timer takes priority over forward RNA. A call transferred to a busy extension transfers back to the station that initiated the transfer.

Use the following instructions to forward an RNA call for cut-to-service.

1. Using the subscriber telephone, lift the handset and listen for the dial tone.
2. Dial the access code or press the function key for forward RNA.

After you perform the action, you hear a second dial tone.



NOTE:

If you do not know the access code or the function key for forward RNA, contact your switch administrator. The switch administrator sets the codes and function keys during the initial setup of the switch.

3. Dial the main extension of the UCD group administered for INTUITY System service.

You created the UCD main extension during the switch administration process in Chapter 7 of this document. The switch now forwards RNA calls to the INTUITY UCD group, creating an integrated voice mail system.

Proceed to the next task.

Task 2: Forward Calls for Busy Conditions

Use this feature to forward calls that reach busy extensions. When the switch attempts to send a call and finds a busy extension, the switch transfers the call to the UCD group assigned to the INTUITY System.



NOTE:

The subscriber's service feature class must contain call forward busy SFI=9. Dterm sets may have a function key for forward on busy (FKY=1).

Use the following instructions to forward a busy call.

1. Using the subscriber telephone, lift the handset and listen for the dial tone.
2. Dial the access code or press the function key for forward on busy.

After you perform the action you hear a second dial tone.



NOTE:

If you do not know the access code or the function key for forward on busy, contact your switch administrator. The switch administrator sets the codes and function keys during the initial setup of the switch.

3. Dial the main extension of the UCD group administered for INTUITY System service.

You created the UCD main extension during the switch administration process in Chapter 7 of this document. The switch now forwards busy calls to the INTUITY UCD group, creating an integrated voice mail system.

Task 3: Forward Subscribers for All Calls

Use this feature to forward subscribers for all calls to the INTUITY System. The switch automatically transfers the call to the UCD group administered for INTUITY service.



NOTE:

The subscriber's service feature class must contain call forward RNA SFI=7. Dterm sets may have a function key for forward all calls (FKY=2).

Use the following instructions to forward all calls.

1. Using the subscriber telephone, lift the handset and listen for the dial tone.
2. Dial the access code or press the function key for forward all calls.

After you perform the action you hear a second dial tone.



NOTE:

If you do not know the access code or the function key for forward all calls, contact your switch administrator. The switch administrator sets the codes and function keys during the initial setup of the switch.

3. Dial the main extension of the UCD group administered for INTUITY System service.

You created the UCD main extension during the switch administration process in Chapter 7 of this document. The switch now forwards all calls to the application UCD group, creating an integrated voice mail system.

4. Repeat steps 1 through 3 for each subscriber extension that uses the INTUITY System.

When you complete the station administration for all subscribers, return to the "Cut-to-Service" chapter in *INTUITY System Software Installation*, 585-310-140, and complete the cut-to-service procedure.

Troubleshooting and Error Logs

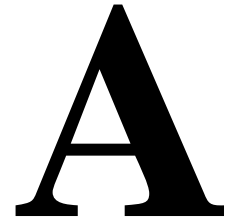

Appendix A provides troubleshooting information to help you isolate and correct problems that may occur with an INTUITY System integrated with the NEAX 2400 MCI switch. The problems outlined in this appendix only refer to problems related to the integration device and processes. If you do not find your problem in this appendix, refer to *INTUITY Platform Administration and Maintenance*, 585-310-534, for more information.

Switch Integration Device Problems

The SID does not power on.

Possible Reason: The power cord connection may be loose or not completed.

Remedy: Make sure the power cord is firmly plugged into the wall outlet and the SID.

Possible Reason: The wall outlet may not have power.

Remedy: Make sure the circuit breaker for the wall outlet is on.

Possible Reason: The SID power switch may be set to the *OFF* position.

Remedy: Turn the SID power switch to the *ON* position.

Possible Reason: The SID may have a bad fuse.

Remedy: Check the fuse on the SID.

Nothing appears on the LCD display.

Possible Reason: You may need to adjust the LCD contrast.

Remedy: Refer to Chapter 8, "Switch Integration Device Administration" for instructions on adjusting the LCD contrast.

Calls are not integrated.

Possible Reason: The cables between the SID and the INTUITY System may not be connected correctly.

Remedy: Refer to Chapter 4, "Hardware Installation", and check the cable connections.

Possible Reason: The INTUITY System may not be administered correctly.

Remedy: Check the administration of the system using Chapter 6 of this document.

Possible Reason: The SID may be administered incorrectly.

Remedy: Refer to Chapter 8, "Switch Integration Device Administration", and check the administration of the system. Make sure the channels and extensions are configured correctly.

Possible Reason: The baud rate for the SID-to-INTUITY System connection may not be set correctly.

Remedy: Refer to Chapter 8, "Switch Integration Device Administration", and set the baud rate correctly.

Possible Reason: The baud rate for the SID-to-PBX MCI connection may not be set correctly.

Remedy: Refer to Chapter 8, "Switch Integration Device Administration" and set the baud rate correctly.

Calls are integrated but the message waiting lamp (MWL) does not work.

Possible Reason: The MWL may not be administered correctly on the INTUITY System.

Remedy: Check the administration of the system using Chapter 6 of this document

Possible Reason: The packet format and MWL codes are set incorrectly on the switch.

Remedy: Refer to Chapter 7, "NEAX 2400 Switch Administration" and set the information correctly.

Possible Reason: The SMDI cable between the INTUITY System and the SID may be defective.

Remedy: Replace the cable.

You receive constant MWI Packet error messages.

Possible Reason: The RS-232 MCI cable may be defective.

Remedy: Replace the cable.

Possible Reason: The baud rate and parity are not configured correctly on the SID.

Remedy: Refer to Chapter 8, "Switch Integration Device Administration" for instructions on configuring the baud rate and parity for the MCI link and the SMDI link.

The LCD display contains the message `Waiting for Remote Access.`

Possible Reason: You did not connect an analog phone line to the modem port.

Remedy: Refer to Chapter 4, "Hardware Installation" for instructions on connecting an analog phone line to the modem port.

The VM LED is yellow constantly (more than 5% packet transmission error).

Possible Reason: The SMDI cable is loose.

Remedy: Tighten the SMDI cable connections.

Possible Reason: The SMDI communications port baud rate, parity, and other settings are not correct.

Remedy: Refer to Chapter 8, "Switch Integration Device Administration", for instructions on configuring the SMDI link.

Possible Reason: The SMDI cable may be defective.

Remedy: Replace the cable. Refer to Chapter 4, "Hardware Installation", for instructions on connecting the SMDI cable.

VM LED is red constantly (more than 50% packet transmission error).

Possible Reason: The SMDI cable is loose.

Remedy: Tighten the SMDI cable connections.

Possible Reason: The SMDI communications port baud rate, parity, and other settings are not correct.

Remedy: Refer to Chapter 8, "Switch Integration Device Administration", for instructions on configuring the SMDI link.

Possible Reason: The SMDI cable may be defective.

Remedy: Replace the cable. Refer to Chapter 4, "Hardware Installation", for instructions on connecting the SMDI cable.

Error Logs

The SID accumulates and records or *logs* error messages. The error messages can help solve problems and trace errors. You can access the error logs on the SID if you are authorized to use security level 1 features.

The error logs also are available to trained support personnel to assist with troubleshooting. Use the instructions in this section to log on to the SID and view the error logs.

1. Press **FUNC** to access the MAIN MENU as shown in the following example:

```

NEC          1-View      2-Utills     3-System
              4-Setup      5-Logs
  
```

2. Press **5** to select Logs. After you press the key, you see the LOGS menu as shown in the following example:

```

LOGS          1-View      2-Purge
  
```

3. Press **1** to view the error logs. After you press the key, you see the an error log screen similar to the following example:

```

ER_LOG          16-Bad PBX Pkts > 5%0000000000000000I
                01/12 12:34  01/16 23:1400000000000056
  
```



NOTE:

Your error log screens may appear different than the screen shown in the example.

Read the following explanation of the error log to understand the information.

16	The error code number used by AT&T support personnel when they access the SID through the remote maintenance modem.
No PBX Pkts in 60 Secs	Informational text that provides a brief description of the error. In the example, the SID wrote an informational message indicating that no packets had been received from the switch in the previous 60 seconds.
I	A letter that indicates the error type and severity. The error messages can be informational (I), warning (W), or error (E) types.
01/12_12:34	The date and time, rounded to the nearest minute, that the error or warning first occurred.
01/16_23:14	The date and time the error or warning last occurred.
56	The number of times the SID produced the error or warning between the first and last occurrence. The number tells you the how frequently the errors occur. If you see a severe error occurring frequently, contact your support representative.

The SID can record many different errors. All errors are displayed in the same format, explained in the above example. You may use the up arrow and down arrow to scroll through the list of messages. Table A-1 lists all SID error codes and contains a description and action for each error code.

Table A-1. SID Error Codes and Descriptions

Code	Description	Type	Action
1	VM Comm Error	W	Check SMDI connection and parameters
2	No Free VM_IN Packets	W	Check SMDI connection and parameters
3	Excess Data -- VM_IN Pkts	W	Check SMDI connection and parameters
5	Bad MWI Pkt	W	Check SMDI connection and parameters
6	No Free Centrex Pkts	W	Check SMDI connection and parameters
10	Excess Data - PBX_IN pkt	W	Check MCI connection and parameters
11	Kernel Error	E	
12	No Free PBX_OUT Packets	W	Check MCI connection and parameters
13	Idle Task Not Enough Time	W	
15	Bad PBX Pkts > 50%	I	Check MCI connection and parameters
16	Bad PBX Pkts > 5%	I	Check MCI connection and parameters
17	System Startup	I	No action required
19	System Powerdown	I	No action required
20	VM Comm Error > 5%	E	Check SMDI connection and parameters
21	VM Comm Error > 50%	E	Check SMDI connection and parameters
22	Boot Error: RTC	E	Set time and date
23	Boot Error: SCC	E	
24	Boot Error: LED	E	
25	Boot Error: Modem	E	
26	Boot Error: DPRAM	E	
27	Bad MWI Pkts > 50%	I	Check SMDI connection and parameters
28	Bad MWI Pkts > 5%	I	Check SMDI connection and parameters
29	PBX Comm Error > 5%	E	Check MCI connection and parameters
30	PBX Comm Error > 50%	E	Check MCI connection and parameters
31	Bad PBX Packet	W	Check MCI connection and parameters
32	Hardware Watchdog Reboot	E	
33	Integration Stop	I	No action required
34	Integration Start	I	No action required
35	No Free PBX_IN Packets	W	Check MCI connection and parameters
36	Hardware Reset	I	No action required
37	VM Remote Reset	I	No action required
38	Software Reset	I	No action required

From time to time, you may need to purge your error logs. You can purge error logs on the SID if you have authorization to access security level 1 features. Use the following instructions to purge error logs.

1. Press **[FUNC]** to access the Main Menu.
2. Press **[5]** to select Logs. After you press the key, you see the Logs menu as shown in the following example:

```
LOGS                1-View                2-Purge
```

3. Press **[2]** to select Purge. After you press the key, you see the screen shown in the following example:

```
PURGE LOGS?                1-Yes                2-No
```

4. Press **[2]** to cancel the purge. The SID save the error logs.
Press **[1]** to erase the error logs.

The SID starts to record new error messages after you purge the old logs. After the SID completes the purge, you see the following message on the screen:

```
Purging Logs...
```

Clearing Your Configuration

When you add voice mail ports or change the switch dial plan, you may need to reconfigure the SID. In most cases, you can accomplish the task by editing the existing setup and restarting the system. If required, the SID provides the capability to restore the factory default settings.

To clear your configuration and restore the factory setting, use the following instructions.

1. Press **FUNC** to access the Main Menu.
2. Press **4** to select the Setup option. After you press the key, you see the SETUP menu as shown in the following example:

SETUP	1-Params	2-Ports	3-Clear
	4-Advanced		

3. Press **3** to select Clear. After you press the key, you see the Clear Setup screen as shown in the following example:

CLEAR SETUP?	1-Yes	2-No
--------------	-------	------

4. Press **2** to cancel the clear and return to the SETUP menu.

Press **1** to restore the factory default settings. When you clear your configuration, you remove all global parameter information, dial plan, logical terminal number information, and SMDI and MCI serial port information. The contrast and Enhanced MWI handling settings are restored to the factory defaults. The only information preserved are your error logs and statistical tables. Using the clear command stops the integration. You must configure and start the system to integrate calls.

Using Views During Integration

B

The SID provides you with four real-time views of the integration process:

- SMDI monitor mode
- MCI monitor mode
- Statistics mode
- Metrics mode

Each mode shows you different information in a common screen layout. A typical view mode appears as shown in the following example:

```
SMDI MWI:          OOP:MWI 0000202
CPID:             ..MD0010001D 0000201...
```

View modes remain on the screen, constantly changing as calls and message waiting transactions are processed. Use the information in this appendix to access and use the view modes.

SMDI Monitor Mode

The first option on the View menu is the SMDI monitor mode. The mode permits you to observe transactions as they occur on the SMDI data link that connects the SID to the INTUITY System. The SMDI monitor is a useful tool that provides condensed, real-time reporting of all transactions on the SMDI data link. The SMDI link connects the SID to the INTUITY System. The view is set as the default display mode for a configured SID. When the system first boots up and is idle, the display appears as shown in the following example:

```
SMDI Idle
```

Use the following instructions to access the SMDI monitor mode.

1. At the NEC Main Menu, press **(1)** to select the View option. You see the following screen:

```
VIEW          1-SMDI          2-MCI          3-Stats
              4-Metrics
```

2. Press **(1)** to select the SMDI option and access the SMDI0 view screen as shown in the following example:

```
SMDI MWI
CPID          ..MD0010002B0000201 0000202...
```

3. To exit the SMDI view screen, press **(MODE)** to return to the NEC Main Menu.

When transactions are being processed, the screen updates continuously. The example SMDI view screen above shows a call covered to the pilot number of the UCD group. The following descriptions explain the content of each field. Each type of view screen contains similar fields.

CPID	The bottom line of the display is reserved for calling party ID packets, or information about the call that the INTUITY System is about to answer.
MD0010002	The number notifies the INTUITY System that the calling party information is specific to message desk 1 and logical terminal number (LTN) 2. This permits the appropriate mail box to be opened on the correct analog voice mail port.
B0000201 0000202	The information represents calling and called party information. In this case, extension 201 called a busy extension 202. The call covered to the UCD group pilot number. The caller at extension 201 listens to the personal greeting for mailbox 202.

When the SID processes a message waiting command, the screen appears as shown in the following example:

```
SMDI MWI:          RMV:MWI  0000201!.
```

The example indicates that the message waiting lamp at extension 201 has been turned on. Since the SID preserves the most recent CPID or MWI transaction on the screen, you can see a mix of information on the screen, as shown in the following example:

```
SMDI MWI:          OOP:MWI  0000202! .
CPID:              ..MD0010001D 0000201  . . .
```

If you attempt to use the view monitor before configuring the SID, the warning shown below appears on your screen. You must first configure your system before you use the view modes.

```
SMDI  Integration Stopped
```

Using MCI Monitor Mode

The SID provides an MCI data link monitor that allows you to view transactions sent between the switch and the SID. This view is similar in format to the SMDI Monitor. The top line on the display shows message waiting commands and the bottom line shows calling party data. Use the following instructions to use the MCI monitor view:

1. Access the View menu as described in the previous section.
2. Press **(MODE)**.
3. Press **(2)** to select the MCI option. You see the following screen.

```
MCI .0!B230100000001.
```

The display updates as packets are transmitted and received on the MCI data link. You see the *Idle message* and the *Integration Stopped* message under the same circumstances as in the SMDI monitor mode.

Using Statistics Mode

Use the following instructions to use the Statistics monitor mode.

1. Access the View menu as described in the previous section.
2. Press **(MODE)**.
3. Press **(3)** to select the Statistics **optn**. You see the following screen.

```
STATS      Calls:      978 BdPkts:      4
           MWIs:      456 BdMWIs: 3 Q: 120-03%
```

The screen updates continuously, showing the total number of calls processed and the number of bad packets received from the switch. The screen also shows the total number of message waiting commands processed, the number of bad MWI packets received from the INTUITY System, and the total number of MWI commands residing in the SID's queue. Use the Statistics mode to monitor activity on your integrated system.

Using Metrics Mode

Use the following instructions to use the Metrics monitor mode.

1. Access the View menu as described in the previous section.
2. Press **(MODE)**.
3. Press **(4)** to select the Statistics **opt.** You see the following screen:

METRICS	Calls/Hr:	12001
	MWIs/Hr:	9071

This display updates occasionally, showing performance measurements for both the SID's call processing and message waiting activities. The top line shows a running average for the number of calls serviced by the INTUITY System per hour. The bottom line shows a similar statistic for the number of message waiting commands serviced by the SID per hour. Use the Metric mode to monitor the performance characteristics of your integrated system.

Clearing Statistical Information

The SID accumulates data that supports the Statistics and Metrics views. You may wish to purge the data to begin taking new measurements, especially when you add subscribers to the system, analog voice mail ports, or change your usage habits. To clear the data, use the following instructions.

1. Log into security level 1. For instructions on logging in to the security level, refer to Chapter , "NEAX 2400 Switch Administration", in this document.
2. Press **(MODE)** at the VIEW action form.
3. Press **(5)** to select Clear and remove the old statistics. After you press the key, you see the following message on the screen:

Clearing Statistics...

The SID clears all statistical information. After a few seconds, the display clears and the SID returns to the View menu.

Switch Administration for INTUITY Lodging

C

Introduction

Appendix C describes the switch administration you need to complete if you have INTUITY Lodging. Read the information and configure your switch as required.

Hunt Group Administration

A hunt group is a set of extension numbers assigned to another phone number. When a call is received by this number, a programmed search of the hunt group is made and the call is forwarded to a member of the hunt group that is not busy. For example, when two calls are made to the designated phone number, both are forwarded to two free extensions in the hunt group. Hunt groups are a commonly-used switch feature. Your switch probably has some hunt groups already assigned.

In order to configure a hunt group for calls being received by the INTUITY system you must:

1. Administer your switch to create a hunt group for your INTUITY system.
2. Have the switch ports that terminate the hunt group extensions wired to the voice ports on the INTUITY platform. Wire them as described in one of the following documents, depending on your system:
 - *INTUITY™ MAP/5 Hardware Installation, 585-310-146*
 - *INTUITY™ MAP/40 Hardware Installation, 585-310-138*
 - *INTUITY™ MAP/100 Hardware Installation, 585-310-139*

Message Retrieval Administration

The message retrieval number is the telephone number that subscribers call to retrieve voice mail messages. Like other calls to the INTUITY system, message retrieval calls are ultimately forwarded to the INTUITY hunt group.

Message Retrieval in Lodging Systems without AUDIX

Provide the INTUITY system's message retrieval number to your subscribers.

Message Retrieval in Systems Shared with AUDIX

There must be two message retrieval numbers in a shared system, one to retrieve from the AUDIX application, and one to retrieve from the Lodging application.

Retrieval from the AUDIX Application

Provide the INTUITY system message retrieval number to your subscribers for the AUDIX application.

Retrieval from the Lodging Application

1. Administer on your switch an extension number *not* associated with a switch port. (These are often called *phantom* or *dummy* numbers.) This number becomes the Lodging message-retrieval number for your system.
2. Configure the Lodging message retrieval number so that the INTUITY hunt group covers all calls.
3. Provide the Lodging message retrieval number to your subscribers for the Lodging application.

Alternate Message Retrieval Method

Guests can also be allowed to log on from a remote phone to any mailbox for which they have a password. A guest will call a number to access this service then enter an extension number and a password to retrieve messages in the mailbox.

To provide this service:

1. Administer on your switch a phantom number. This is the message retrieval number used from a remote phone.
2. Configure the phantom number so the INTUITY system hunt group covers all calls.

3. If your switch has password capability, assign a password to the new extension.

4. Assign to the new extension, the service: **ldg_ni_vm**

- a. Log on to the INTUITY system as sa or craft.
- b. From the INTUITY Administration menu select the following sequence:

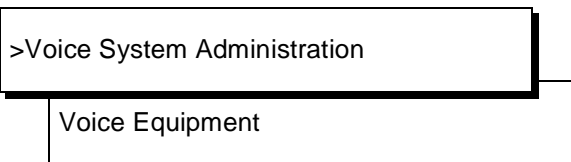

- c. From the Voice Equipment screen, press **CHG-KEYS** (F8) then **ASSIGN** (F3).
 - d. Select Services to Called Numbers from the Assign menu.
 - e. Press **CHOICES** (F2) and select **ldg_ni_vm**.
 - f. Enter the called number that was administered on the switch for this purpose.
 - g. Press **SAVE** (F3). A command-output screen appears confirming your choice.
 - h. Press **CANCEL** (F6) three times to exit to the Voice Equipment screen.
5. If the phantom extension is to be accessed from outside your system, assign the extension to a Direct-Inward-Dialing number.
6. Provide the Lodging message retrieval number to your subscribers for the Lodging application.

Voice Mail Administration

Voice mail is enabled when the switch sends a guest's call to a coverage path. The following procedure, however, provides a separate number that can be used at any time to send voice mail to a guest.

To provide this service:

1. Administer on your switch a phantom number. This number is used to send voice messages to your subscribers.
2. Configure the phantom number so that the INTUITY system hunt group covers all calls.

-
3. Assign to the new extension, the service: **ldg_ni_ca** as follows:
 - a. Log on to the INTUITY system as sa or craft.
 - b. From the INTUITY Administration menu select the following sequence:.

>Voice System Administration

Voice Equipment

- c. From the Voice Equipment screen, press **CHG-KEYS** (F8) then **ASSIGN** (F3).
 - d. Select Services to Called Numbers from the Assign menu.
 - e. Press **CHOICES** (F2) and select **ldg_ni_ca**
 - f. Enter the called number of your choice.
 - g. Press **SAVE** (F3). A command-output screen appears confirming your choice.
 - h. Press **CANCEL** (F6) three times to exit to the Voice Equipment screen.
4. If the phantom extension will be accessed from outside your system, assign the extension to a Direct-Inward-Dialing number.
 5. Provide the Lodging voice mail number to subscribers for the Lodging application.

Call Coverage Path

A coverage path directs the switch to transfer unanswered calls to a hunt group, to a service, or to another extension.

When a call goes to coverage, the switch forwards the called number to the INTUITY system. The INTUITY system detects that the called number is administered as a specific subscriber's extension and treats the call as one to be answered and recorded. Depending on how the extension is configured, the call may be answered by either the AUDIX or the Lodging application.

1. Administer your switch to assign call coverage for each guest's extension to the associated INTUITY system hunt group number.

Do-Not-Disturb

Look for features on your switch that adapt themselves especially well to lodging situations. One example is the *Do-not-Disturb* feature on some switches. This feature makes it possible to request that a particular extension not receive calls until a specified time. At the specified time, the switch automatically deactivates the feature and allows calls to terminate normally at the extension.

If this extension is covered by the INTUITY system hunt group, then calls received while *Do-Not-Disturb* is active will be recorded for later retrieval.

Cut-to-Service

A cut-to-service of the INTUITY Lodging application amounts to changing the coverage path for each guest extension to the INTUITY system hunt group. The associated system must be completely installed before you cut the INTUITY Lodging application into service. Furthermore, all INTUITY system initial administration, associated switch administration, and acceptance tests must be completed.

Some switching systems make it possible to group these extensions as a set allowing the coverage path to be changed simultaneously. Most switching systems permit changing the coverage path for guest extensions one extension at a time. You may use either method.

Gradual Cut-to-Service

Using this cut-to-service strategy, enter guests into the INTUITY Lodging system as they check in. Only new guests, not current guests, receive INTUITY Lodging services.

The advantages of this method include:

- Attendants can learn the new system while only a portion of guests are also learning to use it.
- Guests do not have to learn both the previous and the new systems. Current guests use the previous system; new guests use the INTUITY Lodging system.
- Custom passwords and language options can be assigned to each guest as the guest is checked in.

Gradually cut-to-service as follows:

1. Administer your switch to send the guests' telephone call coverage to the INTUITY system hunt group.
2. Check in each new guest as described in *INTUITY Lodging Administration and Feature Operations, 585-310-559*.

One-Step Cut-to-Service

On switches where a coverage path is separately defined and then applied to a class of stations, assign all guest stations to INTUITY Lodging at once.

Using this cut-to-service strategy, all guest stations are changed to INTUITY Lodging at the same time.

The advantages of this method include:

- Since INTUITY Lodging is brought up in one step, attendants must cope with only one call-answering system at a time.
- Cut-to-service is over at once. Multiple messaging systems can confuse the guests.
- Reasonable coverage options can be assigned to all guests at once; administration can be modified for the few that have unusual requirements.

Cut-to-service as follows:

1. Use INTUITY Lodging to administer the options that guests require.
2. Make sure guests and attendants know when the change will take place and have some idea of how the new service operates.
3. On your switch, determine the coverage path that applies to your guests' stations.
4. On your switch, set the new coverage path for your guests' stations to the INTUITY system hunt group.

Summary

You have completed the switch integration tasks necessary to configure your INTUITY system for the Lodging application.

Abbreviations

A

AC

alternating current

ACD

automatic call distribution

ADAP

administration and data acquisition package

ADU

asynchronous data unit

ALT

assemble load and test

AMIS

Audio Messaging Interchange Specification

AT&T

American Telegraph and Telephone

AUDIX

Audio Information Exchange

AWG

American wire gauge

B

BIOS

basic input/output system

bps

bits per second

BRI

basic rate interface

BSC

binary synchronous communications

BTU

British thermal unit

C

CCA

call classification analysis

CDH

call data handler process

CELP

code excited linear prediction

CIC

customer information center

CICS

customer information control system

CNT

count

CO

central office

COIN

central office implemented network

COM1

serial communications port 1

COM2

serial communications port 2

COR

class of restriction

COS

class of service

CPID

calling party identification pad

CPU

central processing unit

CTS

clear to send

D

DAC
dial access code

DC
direct current

DCE
data communications equipment

DCIU
data communications interface unit

DCP
digital communications protocol

DCS
distributed communications system

DID
direct inward dialing

DIP
data interface process

DMA
direct memory access

DN
directory number

DNIS
dialed number identification service

DSP
digital signal processor

DSU
data service unit

DTE
data terminal equipment

DTMF
dual tone multifrequency

DTR
data terminal ready

E

EIA
Electronic Industries Association

ESD
electrostatic discharge

ESS
electronic switching system

EXT
Extension

F

FACE
framed access command environment

FIFO
first-in first-out

FOOS
facility out of service

FMLI
form and menu language interpreter

FKY
function key

G

GBCS
Global Business Communications Systems

H

Hz
hertz

I

- IDI**
isolating data interface
- IMG**
Interface Module Group
- INADS**
initialization and administration system
- I/O**
input/output
- IRQ**
interrupt request
- ISDN**
integrated services digital network
- IVC6**
integrated voice CELP card (6 channels)

K

- Kbps**
kilobits per second
- Kbyte**
kilobyte (1024 bytes)
- kHz**
kilohertz

L

- LCD**
liquid crystal display
- LED**
light-emitting diode
- LENS**
logical equipment number
- LTN**
logical terminal number
- LWC**
leave word calling

M

- MANOOS**
manually out of service
- Mbyte**
megabyte (one million bytes)
- MCI**
Message Center Interface
- MD**
Message Desk
- MHz**
megahertz
- MMG**
multi-module group
- modem**
modulator/demodulator
- MPDM**
modular processor data module
- ms**
millisecond
- MT**
maintenance (INTUITY™ software component)
- MTBF**
mean time between failures
- MWI**
message-waiting indicator

N

- NW**
INTUITY AUDIX Digital Networking

Abbreviations

O

OA&M

operations, administration, and maintenance

OP

operate

OS

operating system

P

PBX

private branch exchange

PC

power converter or personal computer

PDM

processor data module

PEC

price element code

POST

power-on self test

R

RAM

random-access memory

REN

ringer equivalence number

RMV

remove

RNA

ring-no-answer

ROM

read-only memory

RSC

route restriction class

RTS

request to send

RTU

right to use

S

SCSI

small computer systems interface

SID

switch integration device

SFC

service feature class

SFI

service feature index

SIMM

single in-line memory module

SMDI

simplified message desk interface

SMSI

simplified message service interface

STN

station

STRC

Sales and Technical Resource Center

SW

switch integration (INTUITY software component)

SYS

system

T

TDD

telecommunications device for the deaf

TDM

time division multiplex

TEC

telephone class

TN

tenant number

T/R

tip/ring

TRIP

tip/ring input process

TSC

AT&T's Technical Services Center

U

UCD

uniform call distribution

UMG

ultra-module group

UPS

uninterruptible power supply

V

VM

INTUITY AUDIX Voice Messaging

VP

voice platform (INTUITY software component)

VR

INTUITY Intro Voice Response

VROP

voice response output process

Glossary

1A ESS Switch

An AT&T central office switch that can be integrated with the INTUITY system.

5ESS Switch

An AT&T central office switch that can be integrated with the INTUITY system.

A

accessed message

A voice mail message that was received and scanned (either the entire message or just the header).

ACD

See *automatic call distribution*.

activity menu

The list of options voiced to INTUITY AUDIX subscribers when they first access the system. Selecting an activity is the starting point for all user operations.

ADAP

See *administration and data acquisition package*.

address

INTUITY AUDIX subscriber identification, containing the subscriber's extension and machine, that indicates where the system needs to deliver a voice mail message. An address may include several subscribers or mailing lists. Name or number addressing can be selected with the *A command.

adjunct

A separate system closely integrated with a switch, such as an INTUITY system or a call management system (CMS).

administration

The process of setting up a system (such as a switch or a voice messaging system) to function as desired. Options and defaults are normally set up (translated) by the system administrator or service personnel.

administration and data acquisition package (ADAP)

A software package that allows the system administrator to transfer system subscriber, maintenance, or traffic data from an INTUITY AUDIX system to a personal computer (PC).

ADU

See *asynchronous data unit*.

alarm log

A list of alarms that represent all of the active or resolved problems on an INTUITY system. The alarm log is stored in a software file on disk and can be accessed either locally or remotely on a terminal connected to the system.

alarms

Hardware, software, or environmental problems that may affect system operation. Alarms are classified as major, minor, or warning.

alphanumeric

Alphabetic, numeric, or punctuation symbols.

AMIS

See *Audio Messaging Interchange Specification*.

AMIS Prefix

A number added to the destination number to indicate that the destination number is an AMIS analog networking number.

ampere (amp)

The unit of measurement of electric current. One volt of potential across one ohm causes a current flow of one amp.

analog networking

A method of transferring a voice mail message from one voice messaging system to another whereby the message is played back (voiced) during the transmission from one system to another.

analog signal

A communications path that, in teleprocessing usage, usually refers to a voice-grade telephone line.

announcement fragment

A numbered piece of spoken information that makes up a system message or prompt.

antistatic

A material that is treated to prevent the build-up of static electricity.

asynchronous communication

A method of data transmission in which bits or characters are sent at irregular intervals and bits or characters are spaced by start and stop bits and not by time. See also *synchronous communication*.

asynchronous data unit (ADU)

An electronic communications device that can extend data transmission over asynchronous lines more than 50 feet in length. Recommended ADUs include Z3A1 or Z3A4.

asynchronous transmission

A form of serial communications where each transmitted character is bracketed with a start bit and one or two stop bits. The INTUITY system provides asynchronous RS-232 capabilities for INTUITY AUDIX Digital Networking, if required.

Audio Messaging Interchange Specification (AMIS)

An analog networking feature that allows subscribers to exchange voice mail messages with any voice messaging system that also has AMIS Analog Networking capabilities. Messages can be exchanged with subscribers on INTUITY systems as well as with users on remote voice messaging systems made by vendors other than AT&T.

Audio Information Exchange (AUDIX)

A complete voice messaging system accessed and operated by touch-tone telephones and integrated with a switch.

audit

A software program that resolves filesystem incompatibilities and updates restored filesystems to a workable level of service. Audits are done automatically on a periodic basis, or can be performed on demand.

AUDIX

See *Audio Information Exchange*.

automated attendant

A feature that allows a user of an INTUITY system to set up a main extension number with a menu of options that routes callers to an appropriate department at the touch of a button.

automatic call distribution (ACD)

The System 85, Generic 2, or Generic 3 call-distribution group of analog ports that connects INTUITY subscribers and users to the system. See also *call-distribution group*.

automatic message scan

An INTUITY AUDIX feature that allows subscribers to scan all message headers and messages at the touch of two buttons.

B

background testing

Testing that runs continuously when the system is not busy doing other tasks.

backup

A duplicate copy of files and directories saved on a removable media such as floppy diskette or tape. The backup filesystem may be copied back (restored) if the active version is damaged (corrupted) or lost.

basic input/output system (BIOS)

A system that contains the buffers for sending information from a program to the actual hardware device the information should go to.

baud

A unit of measurement that describes the speed of transferred information.

baud rate

Transmission signaling speed.

basic call transfer

A switchhook-flash method used to send the INTUITY AUDIX transfer command over analog voice ports.

basic rate access

See *basic rate interface*.

basic rate interface (BRI)

International standard protocol for connecting a station terminal to an integrated systems digital network (ISDN) switch. ISDN BRI supports two 64 Kbps information bearer channels (B1 and B2), and one 16 Kbps call status and control (D) channel (a 2B + D format). Also called *basic rate access*.

binary digit (bit)

Two-number notation that uses the digits 0 and 1. Low-order bits are on the right (for example, 0001=1, 0010=2, and so forth). Four bits make a nybble; eight bits make a byte.

binary synchronous communications (BSC)

A character-oriented synchronous link protocol.

BIOS

See *basic input/output system*.

bit

See *binary digit*.

body

The part of subscriber voice mail that contains the actual spoken message. For a leave word calling (LWC) message, it is a standard system announcement.

boot

The operation to start a computer system by loading programs from disk to main memory (part of system initialization). Booting is typically accomplished by physically turning on or restarting the system. Also called *reboot*.

boot filesystem

The filesystem from which the system loads its initial programs.

bps (bits per second)

The number of binary units of information (1s or 0s) that can be transmitted per second. Mbps refers to a million bits per second; Kbps refers to a thousand bits per second.

BRI

See *basic rate interface*.

broadcast messaging

An INTUITY AUDIX feature that enables the system administrator and other designated users to send a voice mail message to all subscribers automatically.

BSC

See *binary synchronous communications*.

buffer

Memory used to compensate for time differences in transmission by temporarily storing data.

bulletin board

An INTUITY AUDIX feature that allows a message to be played to callers who dial the extension. Callers cannot leave a message since it is a listen-only service. Also called *information service*.

bus

An electrical connection/cable allowing two or more wires, lines, or peripherals to be connected together.

busy-out/release

To remove an INTUITY device from service (make it appear busy or in use), and later restore it to service (release it). The INTUITY switch data link, voice ports, or networking ports may be busied out if they appear faulty or if maintenance tests are run.

byte

A unit of storage in the computer. On many systems, a byte is eight bits (binary digits), the equivalent of one character of text.

C

call-answer

An INTUITY AUDIX feature that allows the system to answer a call and record a message when the subscriber is unavailable. Callers may be redirected to the system through the call coverage or call forwarding switch features. Subscribers may record a personal greeting for these callers.

callback number

In AMIS analog networking, the telephone number transmitted to the recipient machine to be used in returning voice mail messages that cannot be delivered.

call coverage

A switch feature that defines a preselected path for calls to follow if the first (or second) coverage points are not answered. The INTUITY system may be placed at the end of a coverage path to handle redirected calls through call coverage, send all calls, go to cover, etc.

call-distribution group

The set of analog port cards on the switch that connects subscribers and users to the INTUITY system by distributing new calls to idle ports. This group (or split) is called automatic call distribution (ACD) on System 85, Generic 2, and Generic 3 and uniform call distribution (UCD) on System 75, Generic 1, and Generic 3. See also *automatic call distribution* and *uniform call distribution*.

call vectoring

A System 85 R2V4, Generic 2, and Generic 3 feature that uses a vector (switch program), allowing a switch administrator to customize the behavior of calls sent to an automatic call distribution (ACD) group.

card cage

An area within the INTUITY hardware platform that contains and secures all of the standard and optional circuit cards used in the system.

cartridge tape drive

A high-capacity data storage/retrieval device that can be used to transfer large amounts of information onto high-density magnetic cartridge tape based on a predetermined format. This tape is to be removed from the system and stored as a backup.

central office (CO)

An office or location in which large telecommunication machines such as telephone switches and network access facilities are maintained. In a CO, private customer lines are terminated and connected to the public network through common carriers.

central processing unit (CPU)

The component of the computer that manipulates data and processes instructions coming from software.

channel capacity

A measure of the maximum bit rate through a channel.

class of service (COS)

The standard set of INTUITY AUDIX features given to subscribers when they are first administered (set up with a voice mailbox).

clear to send (CTS)

Located on Pin 5 of the 25-conductor RS-232 interface, CTS is used in the transfer of data between the computer and a serial device.

CO

See *central office*.

collocated

An INTUITY system installed in the same physical location as the host switch. See also *local installation*.

collocated adjunct

Two or more adjuncts that are serving the same switch (i.e., each has voice port connections to the switch) or that are serving different switches but can be networked through a direct RS-232 connection due to their proximity.

comcode

AT&T's numbering system for telecommunications equipment. Each comcode is a nine digit number that represents a specific piece of hardware, software, or documentation.

command

An instruction or request given by the user to the software to perform a particular function. An entire command consists of the command name and options. Also, one- or two-key touch tones that control a voice mailbox activity or function.

configuration

The particular combination of hardware and software components selected for a system, including external connections, internal options, and peripheral equipment.

controller circuit card

A circuit card used on a computer system that controls its basic functionality and makes the system operational. These cards are used to control magnetic peripherals, video monitors, and basic system communications.

COS

See *class of service*.

CPU

See *central processing unit*.

cross connect

Distribution system equipment used to terminate and administer communication circuits.

cross connection

The connection of one wire to another, usually by anchoring each wire to a connecting block and then placing a third wire between them so that an electrical connection is made.

CTS

See *clear to send*.

D

database

A structured set of files, records, or tables. Also, a collection of filesystems and files in disk memory that store the voice and nonvoice (program data) necessary for INTUITY system operation.

data communications equipment (DCE)

Standard type of data interface normally used to connect to data terminal equipment (DTE) devices. DCE devices include the data service unit (DSU), the isolating data interface (IDI), and the modular processor data module (MPDM).

data communications interface unit (DCIU)

A switch device that allows nonvoice (data) communication between an INTUITY system and an AT&T switch. The DCIU is a high-speed synchronous data link that communicates with the common control switch processor over a direct memory access (DMA) channel that reads data directly from FP memory.

data link

A term used to describe the communications link used for data transmission from a source to a destination. For example, a phone line for data transmission.

data service unit (DSU)

A device used to access digital data channels. DATAPHONE II 2500 DSUs are synchronous data communications equipment (DCE) devices used for extended-local INTUITY system connections. The 2600 or 2700 series may also be used; these are more expensive DSU options and support diagnostic testing and the DATAPHONE II Service network system.

data set

AT&T term for a modem. A data set usually includes the telephone. See also *modem*.

data terminal equipment (DTE)

Standard type of data interface normally used for the endpoints in a connection. Normally the INTUITY system, most terminals, and the switch data link are DTE devices.

data terminal ready (DTR)

A control signal sent from the data terminal equipment (DTE) to the data communications equipment (DCE) that indicates the DTE is on and ready to communicate.

DBP

See *data base processor*.

DCE

See *data communications equipment*.

DCIU

See *data communications interface unit*.

DCP

See *digital communications protocol*.

DCS

See *distributed communications system*.

debug

See *troubleshoot*.

dedicated line

A communications path that does not go through a switch. A dedicated (hard-wired) path may be formed with directly connected cables. MPDMs, DSUs, or other devices may also be used to extend the distance that signals can travel directly through the building wiring.

default

A value that is automatically supplied by the system if no other value is specified.

delivered message

A voice mail message that has been successfully transmitted to a recipient's incoming mailbox.

demand testing

Testing performed on request (usually by service personnel).

diagnostic testing

A program run for testing and determining faults in the system.

dial-ahead/dial-through

The act of interrupting or preceding INTUITY AUDIX system announcements by typing (buffering) touch-tone commands in the order the system would normally prompt for them.

digital

Discrete data or signals such as 0 and 1.

digital communications protocol (DCP)

A 64 Kbps digital data transmission code with a 160 Kbps bipolar bit stream divided into two information (I) channels and one signaling (S) channel.

digital networking

A method of transferring voice mail messages between voice messaging systems in a digital format. See also *INTUITY AUDIX Digital Networking*.

DIP switch

See *dual in-line package switch*.

direct memory access (DMA)

A quick method of moving data from a storage device directly to RAM, which speeds processing.

directory

An INTUITY AUDIX feature allowing you to hear a subscriber's name and extension after typing **N at the activity menu. Also, a group of related files accessed by a common name in software.

display terminal

A data terminal with a screen and keyboard used for displaying INTUITY screens and performing maintenance or administration activities.

distributed communications system (DCS)

A network of two or more switches that uses logical and physical data links to provide full or partial feature transparency. Voice links are made using tie trunks.

distribution list

See *mailing list*.

DMA

See *direct memory access*.

DSR

See *data set ready*.

DSU

See *data service unit*.

DTE

See *data terminal equipment*.

DTR

See *data terminal ready*.

dual in-line package (DIP) switch

A very small switch, usually attached to a printed circuit card, in which there are only two settings: on or off (or 0 or 1). DIP switches are used to configure the card in a semipermanent way.

E

electrostatic discharge (ESD)

Discharge of a static charge on a surface or body through a conductive path to ground. An ESD can be damaging to integrated circuits.

enabled/disabled

The state of a hardware device that indicates whether the INTUITY system can use it. Devices must be equipped before they can be enabled (made active). See also *equipped/unequipped*.

enhanced call transfer

An INTUITY AUDIX feature that allows compatible switches to transmit messages digitally over the BX.25 (data) link. This feature is used for quick call transfers and requires a fully integrated digital switch. Callers can only transfer to other extensions in the switch dial plan.

enhanced serial data interface

A software- and hardware-controlled method used to store data on magnetic peripherals.

equipped/unequipped

The state of a networking channel that indicates whether INTUITY software has recognized it. Devices must be equipped before they can be enabled (made active). See also *enabled/disabled*.

error message

A message on the screen indicating that something is wrong and possibly suggesting how to correct it.

errors

Problems detected by the system during operation and recorded in the maintenance log. Errors can produce an alarm if they exceed a threshold.

escape to attendant

An INTUITY AUDIX feature that allows a subscriber with the call answer feature to have a personal attendant or operator administered to potentially pick up an unanswered call. A system-wide extension could also be used to send callers to a live agent.

ESD

See *electrostatic discharge*.

events

Informational messages about the system's activities. For example, an event is logged when the system is rebooted. Events may or may not be related to errors and alarms.

F

field

An area on a screen, menu, or report where information can be typed or displayed.

file

A collection of data treated as a basic unit of storage.

filename

Alphanumeric characters used to identify a particular file.

file redundancy

See *mirroring*.

filesystem

A collection of related files (programs or data) stored on disk that are required to initialize a INTUITY system and provide full service.

F key

See *function key*.

format

To set up a disk, floppy diskette, or tape with a predetermined arrangement of characters so that the system can interpret meaningful information.

function

Individual steps or procedures within a voice mailbox activity.

function key (F key)

A key on a computer keyboard that performs a defined function when pressed. The user interface for the INTUITY system defines keys F1 through F8.

G

Generic 1, 2, or 3

AT&T switch system software releases. Generic 1, Generic 3i, and Generic 3s correspond to the new generation of System 75-based software. Generic 2 and Generic 3r correspond to the new release of System 85-based software.

generic tape

A copy of the standard software and standalone tape utilities that is shipped with a new INTUITY system.

guest password

A feature that allows users who are not INTUITY AUDIX subscribers to leave messages on the system by dialing a subscriber's extension and entering a system-wide guest password.

H

hard disk drive

A high-capacity data storage/retrieval device that is located inside a computer platform. A hard disk drive stores data on non-removable high-density magnetic media based on a predetermined format for retrieval by the system at a later date.

hardware

The physical components of a computer system. The central processing unit, disks, tape and floppy drives are all hardware.

header

Information that the system creates to identify a message. A message header includes the originator or recipient, type of message, creation time, and delivery time.

help

A command run by pressing (HELP) or (CTRL) (?) on an INTUITY display terminal to show the options available at your current screen position. In the INTUITY AUDIX system, press (*)(H) on the telephone keypad to get a list of options. See also *on-line help*.

hertz (Hz)

A measurement of frequency in cycles per second. A hertz is one cycle per second.

host switch

The switch directly connected to the INTUITY system over the data link. Also, the physical link connecting an INTUITY system to a distributed communications system (DCS) network.

hunt group

A group of analog ports on a switch usually administered to search for available ports in a circular pattern.

Hz

See *hertz*.

I

IDI

See *isolating data interface*.

INADS

See *initialization and administration system*.

information service

See *bulletin board*.

initialization

The process of bringing a system to a predetermined operational state. The start-up procedure tests hardware; loads the boot filesystem programs; locates, mounts, and opens other required filesystems; and starts normal service.

initialization and administration system (INADS)

A computer-aided maintenance system used by remote technicians to track alarms.

initialize

To start up the system for the first time.

input

A signal fed into a circuit or channel.

integrated services digital network (ISDN)

A network that provides end-to-end digital connectivity to support a wide range of voice and data services.

integrated voice processing CELP card

The IVC6 card.

interface

The device or software that forms the boundary between two devices or parts of a system, allowing them to work together.

interrupt request (IRQ)

A device that signals the data bus and the CPU that it needs attention.

INTUITY AUDIX Digital Networking

An INTUITY feature that allows customers to link together up to 500 remote INTUITY machines for a total of up to 500,000 remote subscribers. See also *digital networking*.

I/O address

input/output address.

IRQ

See *interrupt request*.

ISDN

See *integrated services digital network*.

isolating data interface (IDI)

A synchronous, full duplex data device used for cable connections between an INTUITY GPSC-AT/E card and the switch data communications interface unit (DCIU).

J

jumper

Pairs or sets of small prongs on circuit cards and mother boards that allow the user to instruct the computer to select one of its available operation options. When two pins are covered, an electrical circuit is completed.

K

Kbps

kilobits per second. One thousand bits per second.

L

label

The name assigned to a disk device (either a removable tape cartridge or permanent drive) through software. Cartridge labels may have a generic name (such as 3:3) to show the software release or a descriptive name if for backup copies (such as back01). Disk drive labels usually indicate the disk position (such as disk00 or disk02).

LCD

See *liquid crystal display*.

leave word calling (LWC)

A switch feature that allows the calling party to leave a standard (nonvoice) message for the called party using a feature button or dial access code.

LED

See *light emitting diode*.

light emitting diode (LED)

A light indicator on the hardware platform that shows the status of operations.

liquid crystal display (LCD)

The 10-character alphanumeric display that shows status of the system, including alarms.

load

To read software from external storage (such as disk) and place a copy in system memory.

local AUDIX machine

The AUDIX system where a subscriber's voice mailbox is located. All subscribers on this home machine are called *local subscribers*.

local installation

A switch, adjunct, or peripheral equipment installed physically near the host switch or system. See also *collocated*.

local network

An INTUITY AUDIX Digital Network in which all INTUITY systems are connected to the same switch.

login

A unique code used to gain approved access to the INTUITY system. See also *password*.

login announcement

A feature enabling the system administrator and other designated users to create a voice mail message that is automatically played to all INTUITY AUDIX subscribers every time they login to the system.

M

magnetic peripherals

Data storage devices that use magnetic media to store information. Such devices include hard disk drives, floppy disk drives, and cartridge tape drives.

mailbox

A portion of disk memory given to each INTUITY AUDIX subscriber for creating and storing outgoing and incoming voice mail messages.

mailing list

A group of INTUITY AUDIX subscriber addresses assigned a list ID# and public or private status. A mailing list may be used to simplify sending messages to several subscribers.

maintenance

The process of identifying system errors and correcting them, or taking steps to prevent problems from occurring.

major alarm

An alarm detected by INTUITY software that affects at least one fourth of the INTUITY ports in service. Often a major alarm indicates that no service is available.

megabyte

A unit of memory equal to 1,048,576 bytes (1024 x 1024). It is often rounded to one million.

memory

A device which can store logic states such that data can be accessed and retrieved. Memory may be temporary (such as system RAM) or permanent (such as disk).

message categories

Groups of messages in INTUITY AUDIX subscribers' mailboxes. Categories include new, unopened, and old for the incoming mailbox and delivered, accessed, undelivered, undeliverable (not deliverable), and file cabinet for the outgoing mailbox.

message delivery

An optional INTUITY feature that permits subscribers to send recorded messages to any touch-tone telephone, as long as the telephone number is in the range of allowable numbers. This feature is an extension of the AMIS analog networking feature and is automatically available when the AMIS feature is activated.

message-waiting indicator (MWI)

An indicator that alerts subscribers that they have received new voice mail messages. An MWI can be LED, neon, or audio (stutter dial tone).

minor alarm

An alarm detected by maintenance software that affects less than one fourth of the INTUITY ports in service, but has exceeded error thresholds or may impact service.

mirroring

An INTUITY system feature that allows data from crucial filesystems to be continuously copied to backup (mirror) filesystems while the system is running. If the system has some problem where an original filesystem cannot be used, the backup filesystem is placed in service automatically.

modem

A device that converts data from a form that is compatible with data processing equipment (digital) to a form compatible with transmission facilities (analog), and vice-versa.

modular

A term that describes equipment made of plug-in units that can be added together to make the system larger, improve its capabilities, or expand its size.

modular processor data module (MPDM).

A data device that converts RS-232C or RS-449 protocol signals to digital communications protocol (DCP) used by System 75/85, Generic1, and Generic 3 switches. MPDMs may connect INTUITY to a switch DCIU or SCI link or connect terminals to a switch port card.

MPDM

See *modular processor data module*.

MWI

See *message-waiting indicator*.

N

networking

See *INTUITY AUDIX Digital Networking*.

networking prefix

A set of digits that identifies an INTUITY machine.

not deliverable message

A voice mail message that could not be delivered after a specified number of attempts. This usually means that the subscriber's mailbox is full.

O

on-line help

An INTUITY feature that provides information about INTUITY user interface screens by pressing a predetermined key. See also *help*.

operating system (OS)

The set of programs that runs the hardware and interprets software commands.

option

A choice selected from a menu, or an argument used in a command line to modify program output by modifying the execution of a command. When you do not specify any options, the command will execute according to its default options.

OS

See *operating system*.

outcalling

An INTUITY feature that allows the system to dial subscribers' numbers to inform them they have new messages.

outgoing mailbox

A storage area for subscribers to keep copies of messages for future reference or action.

P

parallel transmission

The transmission of several bits of data at the same time over different wires. Parallel transmission of data is usually faster than serial transmission.

password

A code assigned to every INTUITY terminal user and INTUITY AUDIX subscriber for security reasons. After dialing the system, subscribers must dial their personal password correctly to log on. Passwords are also assigned to local and remote networked machines to identify the machines or the network. See also *login*.

PBX

See *private branch exchange*.

PDM (processor data module)

See *modular processor data module (MPDM)*.

peripheral device

Equipment external to the INTUITY cabinet, such as printers or terminals, necessary for full operation and maintenance of the INTUITY system. Also called *peripherals*.

personal directory

An INTUITY AUDIX feature allowing each subscriber to create a private list of customized names.

pinouts

The signal description per pin number for a particular connector.

port

A connection or link between two devices, allowing information to travel to a desired location. For example, a switch port connects to an INTUITY voice port to allow a subscriber to leave a message.

priority messaging

An INTUITY AUDIX feature that allows some subscribers to send messages that are specially marked and preferentially presented to recipients. See also *priority outcalling*.

priority outcalling

Works with the priority messaging feature by allowing the message recipient to elect to be notified by outcalling only when a priority message has been received. See also *priority messaging*.

private branch exchange (PBX)

A private switching system. See also *switch*.

private mailing list

A list of voice mail addresses that only the owning subscriber can access.

private messaging

A feature of INTUITY AUDIX that allows a subscriber to send a voice mail message that cannot be forwarded by the recipient.

processor data module (PDM)

See *modular processor data module (MPDM)*.

processor interface (PI)

A System 75, Generic 1, Generic 3i, Generic 3s, and Generic 3vs switch data link. Also called *processor interface board (PIB)*.

programmed function key

See *function key*.

protocol

A set of conventions or rules governing the format and timing of message exchanges (signals) to control data movement and the detection and possible correction of errors.

public mailing list

A list of voice mail addresses that any INTUITY AUDIX subscriber can use if that subscriber knows the owner's list ID# and extension number. Only the owner can modify a public mailing list.

R

RAM

See *random access memory*.

random access memory (RAM)

The primary memory in a computer that can be overwritten with new information.

reboot

See *boot*.

remote access

Sending and receiving data to and from a computer or controlling a computer with terminals or PCs connected through communications links.

remote installation

A system, site, or piece of peripheral equipment that is installed in a different location from the host switch or system.

remote network

A network in which the systems are integrated with more than one switch.

remote service center

An AT&T or AT&T-certified organization that provides remote support to INTUITY customers. Depending upon the terms of the maintenance contract, your remote service center may be notified of all major and minor alarms and have the ability to remotely log into your system and remedy problems.

remote subscribers

INTUITY AUDIX voice mail subscribers whose mailboxes reside on a remote INTUITY AUDIX Digital Networking machine.

remote terminal

A terminal connected to a computer over a phone line.

REN

See *ringer equivalence number*.

reply loop escape

An INTUITY AUDIX feature that allows a subscriber the option of continuing to respond to a message after trying to reply to a nonsubscriber message.

reply to sender

An INTUITY AUDIX feature that allows subscribers to immediately place a call to the originator of an incoming message if that person is in the switch's dial plan.

request to send (RTS)

One of the control signals on a RS-232 connector that places the modem in the originate mode so that it can begin to send.

restart

An INTUITY feature that allows INTUITY AUDIX subscribers who have reached the system through the call answer feature to access their own mailboxes by typing the *R (Restart) command. This feature is especially useful for long-distance calls or for users who wish to access the INTUITY system when all the voice mail ports are busy. Also, the reinitialization of certain software. For example, restarting the voice system.

restore

The process of recovering lost or damaged files by retrieving them from available backup tapes, floppy diskette, or another disk device.

retention time

The amount of time voice mail messages are saved on disk before being automatically deleted from a subscriber's mailbox.

ringer equivalence number (REN)

A number required in the United States for registering your telephone equipment with the phone company.

RTS

See *request to send*.



S

sales representative

An AT&T or AT&T-certified person who assists you in the purchasing, planning, and implementation of AT&T equipment and solutions.

SCA

See *switch communications adapter*.

scan

To automatically play voice mail messages, headers, or both.

scheduled delivery time

A time and/or date that an INTUITY AUDIX subscriber optionally assigns to a message that tells the system when to deliver it. If a delivery time is omitted, the system sends the message immediately.

SCSI

See *small computer system interface*.

serial transmission

The transmission of one bit at a time over a single wire.

shielded cables

Cables that are protected from interference with metallic braid or foil.

SIMMs

See *single in-line memory modules*.

simplified message service interface (SMSI)

Type of data link connection to an integrated 1A ESS switch or 5ESS switch in the INTUITY system.

single in-line memory modules (SIMMs)

A method of containing random access memory (RAM) chips on narrow circuit card strips that attach directly to sockets on the CPU circuit card. Multiple SIMMs are sometimes installed on a single CPU circuit card.

small computer systems interface (SCSI)

An interface standard defining the physical, logical, and electrical connections to computer system peripherals such as tape and disk drives.

SMSI

See *simplified message service interface*.

split

Group (or queue) of analog ports on the switch. See also *call-distribution group*.

subscriber

An INTUITY user who has been assigned the ability to access the INTUITY AUDIX Voice Messaging system.

surge

A sudden voltage rise and fall in an electrical circuit.

surge protector

A device that plugs into the phone system and the commercial AC power outlet. It is designed to protect the phone system from high voltage surges that could be damaging to the phone system.

switch

An automatic telephone exchange that allows the transmission of calls to and from the public telephone network. See also *private branch exchange (PBX)*.

switched access

A connection made from one endpoint to another through switch port cards. This allows the endpoint (such as a terminal) to be used for several applications.

switch hook

The device at the top of most telephones which is depressed when the handset is resting in the cradle (on hook). This device is raised when the handset is picked up (the phone is off hook).

switch hook flash

A signaling technique in which the signal is originated by momentarily depressing the switch hook.

switch network

Two or more interconnected switching systems.

synchronous communication

A method of data transmission in which bits or characters are sent at regular time intervals, rather than being spaced by start and stop bits. See also *asynchronous communication*.

synchronous transmission

A type of data transmission where the data characters and bits are exchanged at a fixed rate with the transmitter and receiver synchronized. This allows greater efficiency and supports more powerful protocols.

system configuration

See *configuration*.

T

tape cartridge

One or more spare removable cartridges required to back up system information.

tape drive

The physical unit that holds, reads, and writes magnetic tape.

terminal

See *display terminal*.

terminal type

A number indicating the type of terminal being used to log on to the INTUITY system. Terminal type is the last required entry before gaining access to the INTUITY display screens.

terminating resistor

A grounding resistor placed at the end of bus, line, or cable to prevent signals from being reflected or echoed.

tip/ring

A term used to denote the analog telecommunications interface.

tone generator

A device acoustically coupled to a rotary phone, used to produce touch-tone sounds when voice mail subscribers cannot use a regular touch-tone generating voice terminal.

traffic

The flow of attempts, calls, and messages across a telecommunications network.

translations

Software assignments that tell a system what to expect on a certain voice port or the data link, or how to handle incoming data. They customize the INTUITY system and switch features for users.

troubleshoot

The process of locating and correcting errors in computer programs. Also called *debug*.

U

UCD

See *uniform call distribution*.

undelivered message

A message that has not yet been sent to an INTUITY AUDIX subscriber's incoming mailbox. The message resides in the sender's outgoing message and may be modified or redirected by the sender.

Unequipped

See *equipped/unequipped*.

unfinished message

A message that was recorded but not approved or addressed, usually the result of an interrupted INTUITY AUDIX session. Also called *working message*.

uniform call distribution (UCD)

The type of call-distribution group (or hunt group) of analog port cards on some switches that connects subscribers and users to the INTUITY AUDIX system. System 75, Generic 1, Generic 3, and some central office switches use UCD groups. See also *call-distribution group*.

UNIX operating system

A multi-user, multitasking computer operating system.

untouched message

An INTUITY AUDIX feature that allows a subscriber to keep a message in its current category by using the **H (Hold) command. If the message is in the new category, message-waiting indication remains active (for example, the message-waiting lamp will remain lit).

user population

A combination of light, medium, and heavy users on which INTUITY configuration guidelines are based.

V

vector

A customized program in the switch for processing incoming calls.

voice link

The INTUITY analog connection(s) to a call-distribution group (or hunt group) of analog ports on the switch.

voice mail

See *voice message*.

voice mailbox

See *mailbox*.

voice message

Digitized voice information stored by the INTUITY system on disk memory. Also called *voice mail*.

voice port

The IVC6 port that provides the voice interface between the INTUITY system and the analog ports on the switch.

voice terminal

A telephone used for spoken communications with the INTUITY system. A touch-tone telephone with a message-waiting indicator is recommended for all INTUITY AUDIX subscribers.

voicing

Either speaking a message into the INTUITY system during recording, or having the system play-back a message or prompt to a subscriber.

volt

The unit of measurement of electromotive force. One volt is the force required to product a current of one ampere through a resistance of one ohm.

W

watt

A unit of electrical power that is required to maintain a current of one amp under the pressure of one volt.

Index

Numerics

2500 telephone set, 7-2
25-pin connector, 1-4

A

A25B Cable, 1-8
Acceptance tests, 9-1
 test subscribers, 9-2
Access level
 0, 8-14
 1, 8-14
 2, 8-14
Action forms, 2-4, 2-8
Address Ranges
 first, 6-8
 last, 6-8
 public network number, 6-8
Administration
 NEAX 2400, 7-1
 analog voice mail ports, 7-2
ALT
 description, 1-3
Analog lines, 7-2
analog port
 PA-16LCQ, 1-9
Analog ports, 8-2
Assembly, load, and test, 1-3
Autofill, 8-4, 8-5
Automated attendant, 7-2

B

Baud rate, 5-6, 6-4
Book
 commenting on, xv
 related resources, xiv
 trademarks in, xiii

C

Cables
 A25B cable, 1-8
 connections, 4-9
 MCI cable, 1-8
 Null cable, 1-8
 Y-cable, 1-8
call coverage path, lodging switch administration, C-4
Called party information, B-3
Calling party identification pad string
 planning, 3-3
Channels
 planning, 3-4
Clear, A-9
 configuration, A-9
 statistical information, B-5
COM2, 4-9
commands
 Start Voice System, 6-6
Comment, 5-6, 6-4
Comments to this book, xv
Configuration
 saving, 8-7
CPID, B-3
 definition, 3-3
 planning, 3-3
CPID pad string, 8-3
Cut-to-service, 10-1
cut-to-service, lodging, C-5

D

Data link test number, 5-6, 6-4
Date, 8-11
Diagnostic lights
 SID, 2-2
do not disturb feature, lodging, C-5
Dterm, 9-2
 16 button, 9-2
 busy
 FKY=1, 10-3
 eight button, 9-2
 FKY=1, 9-3
 FKY=22, 10-2
 four button, 9-2
dummy number, lodging administration, C-2

E

Edit forms, 2-4, 2-5
 help, 2-8
 clear, 2-8
 insert, 2-8
 overtyping, 2-8
 undo, 2-8
 keys, 2-7
 scroll item, 2-5, 2-6
 single item, 2-5, 2-6
 two item, 2-5, 2-6
EIA
 RS232C, 1-4
EIA standards, 1-4, 4-3
Electronic Industries Association (EIA) standards, 1-4
Electronics Industry Association (EIA) standards, 4-3
Electrostatic discharge, 1-3
ENTER key
 SID, 2-2
Erase
 error logs, A-8
Error code number, A-6
Error logs, A-1, A-5
 code list, A-6
 date, A-6
 purge, A-8
 severity, A-6
 time, A-6
 type, A-6
 viewing, A-5
Extension length, 6-8
Extensions, 8-4, 8-5
 assigning, 8-4
 planning, 3-4

F

Factory assembled systems, 1-3
Fields
 CNT, 7-7
 DATA, 7-12, 7-16, 7-18
 INDEX, 7-12, 7-13, 7-15, 7-17
 LENS, 7-4
 Line Equipment Number, 7-4
 MWI pad string, 8-3
 RSC, 7-5
 SFC, 7-5
 SID
 CPID pad string, 8-3

 MSG desk number, 8-2
 STN, 7-4, 7-7
 STN-A, 7-9
 STN-B, 7-9
 SYS, 7-12, 7-13, 7-15, 7-17
 TEC, 7-4
 tenant number, 7-4
 TN, 7-7, 7-17
 TN-A, 7-9
 TN-B, 7-9
Forms
 action, 2-4, 2-8
 edit, 2-4, 2-5
 help, 2-8
 clear, 2-8
 insert, 2-8
 overtyping, 2-8
 undo, 2-8
 keys, 2-7
 scroll item, 2-5, 2-6
 single item, 2-5, 2-6
 two item, 2-5, 2-6
 menu, 2-4
 name, 2-4
 options, 2-4
 SID, 2-1
 logs, A-5
Forward
 RNA, 10-2
Forwarding
 all calls, 9-4, 10-4
 busy, 9-3, 10-3
 SFI=9, 9-3, 10-3
 RNA, 9-2
Front panel
 SID, 2-2
FUNC key
 SID, 2-2

G

Glossary, IN-1

H

Hardware
 cables, 4-9
 installation, 4-1

- maintenance modem, 4-2
- SID, 2-2
 - diagnostic lights, 2-2
 - front panel, 2-2
 - keypad, 2-2
 - LCD display, 2-2
 - link A, 2-2
 - link B, 2-2
 - modem port, 2-2
 - power cord outlet, 2-2
 - power switch, 2-2
 - rear panel, 2-2
- Host link ID, 6-8
- Host type, 6-8
- hunt group
 - lodging, C-1

I

- Idle, B-4
- Index assignment values, 7-16
- Installation
 - hardware, 4-1
- Integrated call, 9-2
- Integration, 10-2
 - description, 1-1
- Integration stopped, B-4
- Intuity AUDIX transfer feature, 5-1
- Intuity New System Planning, 9-2
- Intuity System Software Installation, 9-1

K

- Keypad
 - SID, 2-2
- Keys
 - FKY=22, 9-2
 - func, 8-2
 - MODE, 8-6

L

- LCD
 - contrast, 8-12
 - display (SID), 2-2
- LED
 - status, 4-9

- Link A
 - connection, 4-9
 - SID, 2-2
- Link B
 - connection, 4-7
 - SID, 2-2
- Local devices, 1-4
- lodging
 - call coverage path, C-4
 - cut-to-service, C-5
 - do not disturb feature, C-5
 - hunt group administration, C-1
 - message retrieval administration, C-2
 - voice mail administration, C-3
- Logical terminal number
 - planning, 3-4
- LTNs, 8-4
 - assigning, 8-4
 - planning, 3-4

M

- Maintenance modem, 4-2
- MAP/100 Voice Processing Hardware Installation, 9-1
- MAP/40 Voice Processing Hardware Installation, 9-1
- MAP/5 Voice Processing Hardware Installation, 9-1
- MCI, 1-1, 3-3
 - administration
 - port terminal, 7-15
 - UCD group, 7-16
 - baud rate
 - planning, 3-3
- MCI Cable, 1-8
- MCI I/O port, 4-4
 - baud rate, 4-4
 - dip switches
 - defaults, 4-6
 - settings, 4-4
 - table, 4-4
 - parity, 4-4
 - word length, 4-4
- MCI link, 7-10
 - administration, 7-10
 - MWI, 7-10
 - port, 7-13
 - connection
 - SID, 4-7
 - switch, 4-3
- MCI monitor mode, B-4
- MCI port, 1-4
- menu
 - Intuity system

- administration, C-3
- Menu forms, 2-4
 - example, 2-4
 - name, 2-4
 - options, 2-4
- Message center interface, 1-1
- message retrieval, lodging, C-2
- Messages
 - idle, B-4
 - integration stopped, B-4
 - PKG check, 7-5
 - WRT, 7-5
- Metrics mode, B-5
- MODE key
 - SID, 2-2
- Modem
 - maintenance, 4-2
- Modem port
 - SID, 2-2
- MWI, 8-13
 - administration
 - MCI, 7-10
 - pad string
 - planning, 3-3
 - SID, 8-13
- MWI feature
 - planning, 3-3
- MWI pad string, 8-3
- MWL
 - enhanced processing, 8-14
- MWL Interleave Factor, 8-13

N

- NEAX 2400, 1-1, 5-4
 - 5200 Feature Application Floppy Disk, 1-9
 - administration, 7-1
 - analog voice mail ports, 7-2
 - backplane, 1-4
 - hardware checklist, 1-9
 - IMG, 1-9
 - MMG, 1-9
 - PA16LCQ analog ports, 1-10
 - recall timer, 1-10
 - SIM, 1-9
 - UCD Overflow, 3-2
 - UMG, 1-9
 - wink, 1-10
- Null Cable, 1-8

P

- PA-16LCQ, 1-9
- Parity
 - MCI I/O port, 4-4
- Password, 8-15
- phantom number, lodging administration, C-2
- PKG check, 7-5
- Planning
 - baud rate
 - MCI, 3-3
 - SMDI, 3-4
 - calling party identification pad string, 3-3
 - extensions, 3-4
 - logical terminal number, 3-4
 - message desk number, 3-2
 - MWI feature, 3-3
 - MWI pad string, 3-3
 - switch integration, 3-1
 - voice mail ports, 3-2
 - worksheets, 3-1
- Port
 - administration
 - MCI, 7-13
 - data field values, 7-14
- Ports, 8-4, 8-8
- Power cord, 4-9
 - connection, 4-9
 - SID, 4-9
- Power cord outlet
 - SID, 2-2
- Power switch
 - SID, 2-2
- Purge
 - error logs, A-8

R

- Rear panel
 - SID, 2-2
- Recources to use with this book, xiv
- Requirements
 - NEAX 2400, 1-1
- Ring-No-Answer, 10-2
- RNA, 9-2, 10-2
 - SFI=8, 10-2
 - SFT=8, 9-2

S

Safety

- electrostatic discharge, 1-3
- work mat, 1-3
- wrist strap, 1-3

screen

- Intuity system
 - voice equipment, C-3

screens

- assignment of station data, 7-12, 7-13, 7-15, 7-17
- Confirmation Message, 5-7, 6-5
- installation commands menu, 7-11
- Intuity Administration menu, 5-3
- Intuity Main Menu, 6-2

NEAX

- 2400 maintenance command menu, 7-2
- assignment of station data, 7-4

NEAX2400

- station data commands, 7-3

SID

- baud rate, 8-9
- byte length, 8-10
- clear setup, A-9
- contrast, 8-12
- date and time, 8-11
- MCI main menu, 8-2
- MWI feature, 8-3
- params, 8-2
- parity, 8-10
- serial, 8-9
- setup, 8-2, 8-4, 8-14
- SMDI, B-2
- SMDI view mode, 8-8
- stop bits, 8-10
- system tools, 8-12
- UTILS, 8-9
- VM port, 8-4
- SIDadvnc, 8-14
- SID-login, 8-15
- Software Install menu, 5-3
- Switch Interface Administration menu, 6-2
- Switch Link Administration, 5-4
- System Control menu, 5-2
- System Translation, 6-7

Security, B-5

Security level, 8-14, A-5, B-5

- password, 8-15

Serial data link, 8-9

- Centrex, 8-9
- MCI, 8-9

SMDI, 8-9

Serial port, 5-6, 6-4

Service Marks, xiii

services to called numbers field, Intuity, C-3

SID, 1-1

- administration, 8-1
 - basic parameters, 8-2
- date, 8-11
- error logs, A-1, A-5
 - viewing, A-5
- factory default settings, A-9
- forms, 2-1
- hardware, 2-2
 - diagnostic lights, 2-2
 - front panel, 2-2
 - keypad, 2-2
 - LCD display, 2-2
 - link A, 2-2
 - link B, 2-2
 - modem port, 2-2
 - power switch, 2-2
 - power cord outlet, 2-2
 - power switch, 2-2
 - rear panel, 2-2

LCD

- contrast, 8-12
- message waiting lamps, 8-13
- MWI, 8-13
- placement, 1-4
- software, 2-4
- system parameters, 8-11
- time, 8-11, 8-12
- views, B-1
 - MCI monitor mode, B-4
 - metrics mode, B-5
 - SMDI monitor mode, B-2
 - statistics mode, B-4
- voice mail ports, 3-2

SID Switch Integration Package, 5-4

SID Switch Integration Software, 5-1

Simplified Message Desk Interface, 3-3

- planning, 3-2

Simplified message desk interface, 1-1

SMDI, 1-1

- baud rate
 - planning, 3-4
- planning, 3-2

SMDI monitor mode, B-2

SMDI packet, 8-8

Software

- installation, 5-1
- login, 5-1

Start integration, 8-7

Statistics mode, B-4
Subscribers
 test, 9-2
Switch group, 7-6
Switch integration device, 1-1
Switch link type, 6-8
System parameters
 SID, 8-11

T

Test subscribers, 9-2
Time, 8-12
Trademarks, xiii
Transfers, 1-10
Troubleshooting, A-1

U

UCD group, 1-1, 7-6, 9-2, 10-2, 10-3, 10-4
 assignments
 voice mail extensions, 7-6
 forward target number, 7-6
 illustration, 1-2
 MCI group, 7-16
UCD Overflow, 3-2, 7-6
UCD overflow
 administration, 7-8
UMG, 1-9
Uniform Call Distribution group, 1-1, 7-6

V

Views, B-1
 MCI monitor mode, B-4
 metrics mode, B-5
 SMDI monitor mode, B-2
 statistics mode, B-4
voice equipment screen, C-3
voice mail administration, lodging, C-3
Voice mail ports, 8-2

W

Windows, 2-8

wiring, switch port for lodging, C-1
Word length
 MCI I/O port, 4-4
Work mat, 1-3
Worksheets
 planning, 3-1
Wrist strap, 1-3

Y

Y-Cable, 1-8