

Aastra DT690

Cordless Phone for MX-ONE™

USER GUIDE



Aastra

Copyright

© Copyright Aastra Telecom Sweden AB 2010. All rights reserved.

Disclaimer

No parts of this publication may be reproduced, stored in retrieval systems, or transmitted in any form or by any means, electronic, mechanical, photocopying, recording or otherwise, without prior written permission of the publisher except in accordance with the following terms.

If this publication is made available on Aastra media, Aastra gives its consent to downloading and printing copies of the content provided in this file only for private use and not for redistribution. No parts of this publication may be subject to alteration, modification or commercial use. Aastra will not be liable for any damages arising from use of an illegal modified or altered publication.

1 Introduction

WARRANTY

AASTRA MAKES NO WARRANTY OF ANY KIND WITH REGARD TO THIS MATERIAL, INCLUDING, BUT NOT LIMITED TO, THE IMPLIED WARRANTIES OF MERCHANTABILITY AND FITNESS FOR A PARTICULAR PURPOSE. Aastra shall not be liable for errors contained herein nor for incidental or consequential damages in connection with the furnishing, performance or use of this material.

TRADEMARK

Aastra is a registered trademark of Aastra Technologies Limited. All other trademarks mentioned herein are the property of their respective owners.

1.1 About this User Guide

This guide describes the available features of the DT690 cordless phone when it is connected to MX-ONE™.

The DT690 cordless phone is rich of features, with a color display, telephony, messaging, and Bluetooth (optional). The phone is designed for use in a medium demanding environment, such as hospital environment, light industry environment, and office environment.

Depending on the version and configuration of the exchange that your phone is connected to, some of the functions and features described in this user guide may not be available. There can also be some differences in the way your phone is programmed. Please consult the system administrator if you need further information. Some markets use differing codes for some features. In this guide the features are described using the most common codes. The latest version of the user guide can be downloaded from www.aastra.com.

1.2 Preparing for Use

Before using your phone for the first time, you have to charge and connect the battery, see Installation on page 117.

Note: Place the phone in the charger and charge it for at least one hour before using it the first time.

1.3 IPEI and IPDI Codes

Your phone has a unique IPEI code (International Portable part Equipment Identity), and a unique global GAP identity number for the DECT registration (IPDI). The IPEI and IPDI codes are used for network subscription of the phone.

At delivery, the phone's IPEI and IPDI codes are identical, and either of them can be used for network subscription.

Note: If the phone is replaced by another phone using the *easy replacement procedure*, the IPDI code changes. If the IPEI and IPDI codes differ, the IPDI code should be used for network subscription.

To look up the IPEI and IPDI codes, do the following:

1. Dial ***#06#** when the phone is in idle mode.
The IPEI and IPDI numbers appear in the display.
2. Press **Back** to return to idle mode.

Note: If your phone is broken and needs to be replaced with another phone, please contact the system administrator.

1.4 Software Version

To view the phone's software version:

1. Dial ***#34#** when the phone is in idle mode.
2. Select **Software** and press **Select**.
Details about the software version appear in the display.
3. Press **Back** until you return to idle mode.

1.5 Accessibility and Voice Quality

The base network is not always available. If you cannot connect to the system, contact the system administrator. For best voice quality, avoid positioning yourself near a computer, a radio, or similar equipment.

1.5.1 Operating area

You can use your cordless phone in the area that is covered by the network. Outside this area you will lose contact with the phone network. The signal strength icon, , will disappear and the text `No System` will be displayed.

1.5.2 Out of Range

When you leave the system coverage area you will hear a short beep and see a lamp indication, and the text `Searching` will appear in the display. The out of range beep will be repeated every minute for 30 minutes. To switch off the beep, press and hold the mute key, . When reentering the coverage area, it takes a few minutes before the phone registers into the system.

1.5.3 Standby Time

Poor radio signals (far away from the system base station) reduce the handset standby and talk times. High loudspeaker or ringer volume, frequent key activation and display illumination as well as active vibration alarm and Bluetooth operation, are features that can specifically shorten standby and talk times.

2 Safety Instructions

Read this section before using the telephone.

For safe and efficient operation of the telephone, observe the guidelines given in this manual and all necessary safety precautions when using the telephone. Follow the operating instructions and adhere to all warnings and safety precautions located on the product, the Quick Reference Guide and this User Manual.

This product shall only be used with the following batteries:

- Art.No.: 660216 Battery

Single chargers shall only be connected with power adapters supplied by the manufacturer.

Available power adapters (Suppliers Designation) are:

- Art.No.DC3: 130160A Power supply unit AC/5V DC/0.65A
- Europe
- Art.No.DC3: 130166A Power supply unit AC/5V DC/1A
- USA, Canada, AUS, and UK
- Art.No.DC4: 130161A Power supply unit AC/5V DC/2A
- Europe, USA, Canada, AUS, and UKAA

2.1 Precautions

- **Save this manual.** It includes important safety information and operating instructions. Save all instructions for future reference.
- Before using the handset, users of hearing aids should note that radio signals can affect hearing aids and, if powerful enough, can cause an unpleasant buzzing sound.
- Connect AC (power supply) to the desktop battery charger only to designated power sources as marked on the product.
- **Danger:** Never alter the AC cord or plug. If the plug will not fit into the outlet, have a proper outlet installed by a qualified electrician. Improper connection increases the risk of electric shock.
- Position the electrical cord to the AC power supply where it is least likely to be subjected to damage or stress.
- Remove the electrical cord from an outlet by pulling gently on the AC adapter, not by pulling the cord.

- Remove the battery before cleaning the telephone to reduce risk of electric shock.
- Unplug the battery charger from a power source before cleaning the telephone to reduce risk of electric shock.
- Do not use the telephone with auxiliary equipment not exclusively recommended by the manufacturer, as it may result in fire, electric shock, or injury, and will void the warranty.
- Do not disassemble the telephone. Disassembling the telephone voids the warranty. The telephone consists of no consumer serviceable components. Service should be performed by Authorized Service centre only.
- Changes or modifications to the equipment not expressly approved by the party responsible for compliance could void the user's authority to operate the equipment.
- Do not allow heavy objects to fall on the telephone.
- Do not allow children to play with the product packaging material. Product packaging material is often small and may present a choking hazard.
- Do not allow children to play with the telephone. It is not a toy. Children could hurt themselves or others. Children could also damage the telephone.
- Always keep and handle your products with care and keep them in a clean and dust-free place. Proper use and care will prolong the product's life. Use a soft absorbent tissue or cloth to remove dust, dirt or moisture.
- For long and safe operation with optimal performance the battery need to be replaced regularly.
- Do not put the product in a microwave oven as this may cause damage to either the oven or the product.
- Do not paint your product.
- To avoid hearing impairment, accept the call before holding your product (or portable handsfree device) to your ear.

2.1.1

Frequency Range

The telephone is a radio transmitter and receiver. When it is on, it receives and sends out radio frequency (RF) energy. The telephone operates on different frequency ranges depending on market and employs commonly used modulation techniques:

EU	1880-1900 MHz
USA	1920-1930 MHz
Latin America	1910-1930 MHz
Brazil	1910-1920 MHz
Other countries (except China)	1900-1920 MHz

2.2

Regulatory Compliance Statements (EU and EFTA only)

Hereby, Aastra Telecom Sweden AB, Box 42214, SE-126 17 Stockholm, declares that this telephone is in conformity with the essential requirements and other relevant provisions of the European Directive 1999/5/EC (R&TTE Directive).



Details to be found at: <http://www.aastra.com/sdoc>

2.3

Regulatory Compliance Statements (USA and Canada only)

Portables without Bluetooth	Portables with Bluetooth
FCC ID:BXZDH4	FCC ID:BXZDH4BL
IC: 3724B-DH4	IC: 3724B-DH4BL
US: 9FVW4NANDH4	US: 9FVW4NANDH4

2.3.1 FCC Compliance Statements

This equipment has been tested and found to comply with the limits for a Class B digital device, pursuant to Part 15 of the FCC Rules.

These limits are designed to provide reasonable protection against harmful interference in a residential installation. This equipment generates, uses and can radiate radio frequency energy and, if not installed and used in accordance with the instructions, may cause harmful interference to radio communications.

However, there is no guarantee that interference will not occur in a particular installation. If this equipment does cause harmful interference to radio or television reception, which can be determined by turning the equipment off and on, the user is encouraged to try to correct the interference by one or more of the following measures:

- Reorient or relocate the receiving antenna.
- Increase the separation between the equipment and receiver.
- Connect the equipment into an outlet on a circuit different from that to which the receiver is connected.
- Consult the dealer or an experienced radio/TV technician for help.

Privacy of communications may not be ensured when using this phone.

2.3.2 Exposure to Radio Frequency Signals

This EUT has been shown to be capable of compliance for localized specific absorption rate (SAR) for uncontrolled environment/general population exposure limits specified in ANSI/IEEE Std. C95.1-1992 and had been tested in accordance with the measurement procedures specified in FCC/OET Bulletin 65 Supplement C (2001) and IEEE 1528-2003.

This equipment complies with FCC radiation exposure limits set forth for an uncontrolled environment. This device complies with FCC SAR limit of 1.6 W/kg. The maximum SAR value measured when used at the ear, and when worn on the body using belt clip are:

SAR values	With Bluetooth	Without Bluetooth
Head	0.104 W/Kg	0.072 W/kg
Body worn	0.029 W/Kg	0.036 W/kg

This device must not be co-located or operating in conjunction with any other antenna or transmitter.

Use of non-Aastra approved accessories may violate the FCC RF exposure guidelines and should be avoided.

2.3.3 Information to User

This device complies with Part 15 of the FCC Rules. Operation is subject to the following conditions:

- (1) this device may not cause harmful interference, and
- (2) this device must accept any interference received, including interference that may cause undesired operation.

2.3.4 IC Requirements for Canada

This Class B digital apparatus complies with Canadian ICES-003.
Cet appareil numérique de la Classe B conforme à la norme NMB-003 du Canada.

The wireless phone is a radio transmitter and receiver. It is designed and manufactured not to exceed the emission limit for exposure to radio frequency (RF) energy set by the Ministry of Health (Canada), Safety Code 6. These limits are part of comprehensive guidelines and established permitted levels of RF energy for the general population. These guidelines are based on the safety standards previously set by international standard bodies. These standards include a substantial safety margin designed to assure the safety of all persons, regardless of age and health.

This device has been shown to be capable of compliance for localized specific absorption rate (SAR) for uncontrolled environment / general public exposure limits specific in ANSI/IEEE C95.1-1992 and had been tested in accordance with the measurement procedures specified in IEEE 1528-2003.

2.4 Bluetooth Qualified Design ID

Bluetooth QD ID: B016451

2.5 Environmental Requirements

2.5.1 Cordless Telephone

- **Note:** Do not use the cordless phone in areas with a danger of explosion, as it is not specified as intrinsically safe.
- Only use the telephone in temperatures between 0° C to +40° C (32° F to 104° F).
- Avoid exposing the telephone for direct sunlight or close to other heat sources.
- Do not expose the telephone to open flame.
- Keep the telephone away from excessive heat and moisture.
- Moving the equipment rapidly between warm and cold temperatures may cause condensation (water droplets) to form on its internal and external surfaces. Water droplets may cause malfunction of the equipment and corrupt or end communication or damage the equipment. When condensation is noticed, stop using the equipment. Switch off the phone, remove the battery and unplug the mains adapter from the power outlet. Wait until the moisture evaporates from the equipment before putting it in operation again.
- Protect your telephone from aggressive liquids and vapours.
- If the telephone has been exposed for water or condense, remove the battery immediately and let it dry completely before re-inserting the battery.
- Do not place a cold telephone in a charger.
- If the liquid crystal display breaks, avoid injury by preventing the liquid crystal from coming into contact with eyes, skin or mouth. Prevent the liquid crystal from leaking out of the broken glass.
- In case of smoke or fumes, stop operating the product and turn it off immediately. Unplug the mains adapter and remove the batteries from the phone immediately. Continued operation may result in fire or electrical shock.

2.5.2 Battery

- Do not immerse the battery into water. This could short-circuit and damage the battery. If the battery has been exposed to water or condense, remove it immediately and let it dry completely before reinserting it.

- Do not expose a battery to an open flame. This could cause the battery to explode.
- Never carry or store the battery together with electrically conducting objects (neck chains, pencil leads, etc.)
- If you ever notice liquid leaking out, unusual odour, build-up of heat, discolouration, deformation or any other abnormal condition when you use, charge or store the battery, remove the battery immediately from the handset and keep it away from naked flames.
- The battery fluid can damage your sight. If at any time battery fluid accidentally gets into your eyes, rinse your eyes immediately with clean tap water and contact a doctor.
- Do not allow the metal contacts on the battery to touch another metal object. This could short-circuit and damage the battery.
- Do not leave a battery where it could be subjected to extremely high temperatures, such as inside a car on a hot day.
- Use the Desktop Charger or the wall mounted Charging Rack for charging. Charge the battery for at least one hour the first time you use the battery. Note that the wall mounted charger with a battery pack adapter has to be used if the battery alone is to be charged.
- Do not charge a battery when the ambient room temperature is above 40 °C or below +5 °C (above 104° F or below 41 °F).
- Do not attempt to take a battery apart.
- Do not disconnect the battery unless it needs to be replaced.
- Turn off the telephone before removing the battery.
- Unplug the battery charger from a power source before cleaning the phone to reduce risk of electric shock.
- Only charge the battery when it is placed in the phone.
- Never heat or dispose of the battery into a fire, which, or else, may cause leakage, burst or fire.
- Remove the carrying case from the product while in charger.
- Do not cover the product while it is being charged. Do not charge the phone in a closed cabinet or drawer. The charging of the battery is a chemical process and causes the battery to become warm during charging. Make sure the environment in which the phone is charged, is well ventilated.
- The cordless phone can be charged either when switched on or off.
- Do not, under any circumstance, connect the battery's positive and negative leads altogether.

- Do not strike or drop the battery. It may cause damage to the battery.
- The battery should be stored in a dry place, with the ambient temperature of approximately +25°C (+77°F) for best performance.
- The battery continues to discharge a minimal portion of its power, even if the product is switched off or the battery is removed.

2.5.3



Disposal of Telephone and Batteries

Defective phones or batteries should not be placed in municipal waste. Please check local regulations for disposal of electronic products.

3 DT690 Description

This chapter describes the DT690 cordless phone and its display, menu structure, and tones. The phone is shown in figure 1 on page 14.

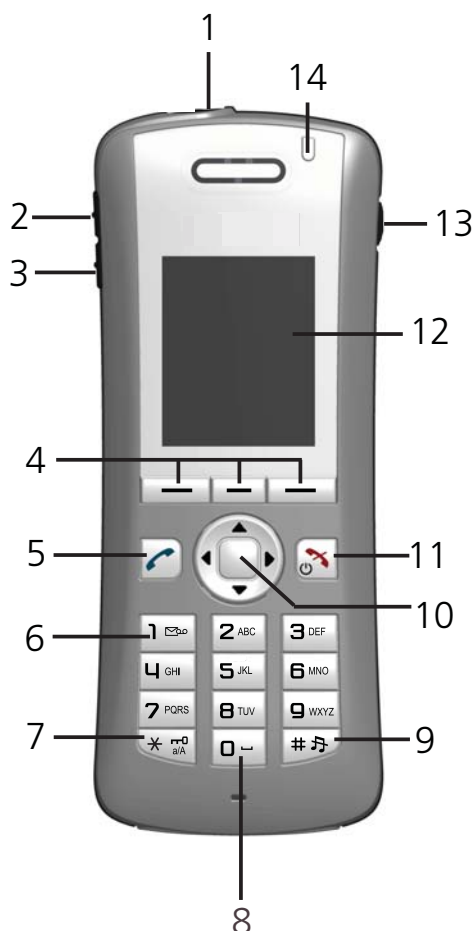

Figure 1: Overview of the DT690 cordless phone

- 1 Multifunction button**
Can be used as a shortcut to functions, or used in long or double press modes
- 2 Speaker volume up key**
Used to increase the speaker volume
- 3 Speaker volume down key**
Used to decrease the speaker volume
- 4 Soft keys**
Can be pre-programmed or used with the GUI
- 5 Off-hook key**
Used to connect calls, and as a shortcut to the call list.

- 6 Voice mail access**
Used to listen to voice mail messages
- 7 Key lock and upper and lower case**
A combined key lock and shift key for upper and lower case
- 8 Space**
Used to add space between text
- 9 Mute key**
Used to switch audio on and off in idle mode, to silence the ring signal, and to switch the microphone off and on during a call
- 10 Navigation key**
Used to navigate left, right, up, and down, and to confirm (the middle key) a selection. It is also possible to program the navigation keys (except the middle key) for shortcuts.
- 11 On-hook key and power on and off**
A combined key used to end a call, to return to idle mode, and to switch the phone on and off with a long press
- 12 Display**
The display is 128 pixels wide and 160 pixels high. The display has multiple colors and backlighting
- 13 Headset connector**
The headset connector is used to connect a headset. The headset connector cover protects the connector against dust
- 14 Indication lamp**
Indicates incoming calls and messages, low battery, and charging status

3.1

Functions and Accessories

The DT690 functions are listed in table 1 on page 15, and its accessories are listed in table 2 on page 16.

Table 1 Functions

Local phonebook (250 entries)
Central phonebook *
Company phonebook (1,000 entries) **
Downloadable language **
Vibrator
Headset connector
Microphone on/off during call

Loudspeaking function
SMS (Short Message Service) *
Voice mail access *
Centralized management *
Easy replaceable battery
Easy replacement of telephone
Bluetooth (optional)

* This is a system dependent feature.

** This feature requires configuration in WinPDM or CPDM.

Table 2 Accessories

Desk charger
Desk PDM charger
Rack PDM charger
Battery pack rack charger
Leather case
Belt clip, hinge type
Belt clip, swivel type
Security chain
Headset with microphone on boom
Headset with microphone on cable
Bluetooth headset (optional)

3.1.1

Accessories

Case

The plastic cover parts are made of durable PC/ABS material.

Antenna

The antenna is integrated inside the phone.

Loudspeaker

A separate loudspeaker for the loudspeaking function is placed at the back side of the phone.

Microphone

The microphone is placed at the front bottom side of the phone.

Clips

There are two different belt clip options to the cordless phone; a standard (hinge) clip and a security (swivel) clip. Use the clip to attach the phone to a belt or similar. See also Belt Clip on page 118. It is also possible to use the phone without any clip.

Battery

The battery is a rechargeable Li-Polymer battery, placed under a battery cover. The battery is fully charged within four hours.

3.2 Display Information

The icons and text in the display indicate functions and settings available to the user. The display gives visual feedback on all actions performed, and also textual warnings, see figure 2 on page 17. The owner ID can be set manually by the user.

Note: If a name is available it is displayed together with, or instead of, the number.

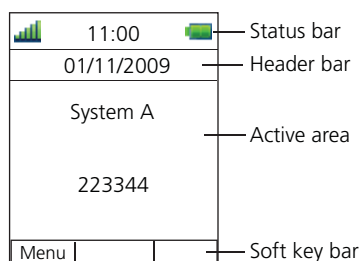

Figure 2: Example of a display in idle mode

Status bar The top row (Status bar) is used for icons giving the user information about signal strength, missed call, new message, phone lock, key lock, sound off, time and battery status. This row is always visible.

Header bar The second row (Header bar) displays the current date, headset connection, Bluetooth connection, and system connection.

- Active area** The next rows (Active area) are used for information such as the name of the system to which the cordless phone is connected. A user identity provided from the system, or an owner ID, can also be displayed if it has been configured in the Settings tab. This is also the area for popup text, missed calls or to confirm an action.
- Soft key bar** The bottom row (Soft key bar) is used for soft keys which can be used as shortcuts for functions in the phone. There are three soft keys located just beneath the display. The function of each soft key is indicated by text in the display just above the key, see figure 3 on page 18. In idle mode, the soft keys can be used for specific functions defined by the user of the phone.

3.2.1

Soft keys

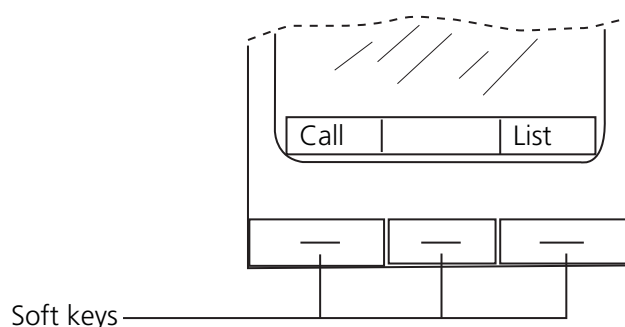

Figure 3: Soft keys “Call” and “List”

Note: The information displayed varies depending on the version and configuration of the exchange, and whether you use the phone in a DECT or an IP DECT system. Consult the system administrator to find out which type of system your phone is used in.

Depending on the state and setting of your phone, different information can be shown, see the following list:

- **Idle phone**
 - Normal.
The display shows the programmed name of your network, your name and extension number, time and date, and so on, see figure 3 on page 18.
 - Follow-me activated.
The display shows your own extension number followed by a > and the number your extension has been diverted to.

- **Outgoing call**
 - Normal outgoing call.
When you make an outgoing call, the dialed number or name is displayed.
 - Diverted call.
If the dialed number is diverted, the diversion information is shown. The display shows, for example, the dialed number and the number diverted to (preceded by >). When the diverted call is answered, only the number of the answering position is displayed.
- **Incoming call**
 - Normal incoming call.
If available, the number or the name of the caller is displayed.
 - Diverted call.
A diversion indicator (>) before the number or name tells you that the call is diverted to your extension. When you have answered the call, the display shows only the number of the person calling.

3.2.2 System Connection Messages















Possible system connection messages that can be displayed on your phone is described below.











Shown in display	Indicating	Description
System A	System Indication	The phone has contact with System A. It is also possible to assign the system a name of your choice.
No System	Out of coverage	The phone is out of coverage. Go into range, or contact the system administrator. <small>When reentering the coverage area it can take a couple of minutes before the phone has registered automatically into the system.</small>
No access	Access Indication	The phone has contact with a system, calling is not allowed.
No Subscription	System Indication	The phone is not in contact with any system. Ask the system administrator to log on the phone.

3.2.3

Display Icons

The display icons are described below.









Icon	Description
	<p>Signal strength Shown in the upper left corner, when the phone is connected to a system. The staples shown in display depends on the signal strength.</p>
	<p>Full battery Shown in upper right corner.</p>
	<p>Low battery Shown when 10% or less remains of the battery capacity.</p>
	<p>Empty battery Flashing when the remaining battery capacity is 5% or lower.</p>
	<p>Loudspeaking Displayed in the soft key bar during a call. Pressing this icon will activate loudspeaking mode.</p>
	<p>Loudspeaking off Displayed when loudspeaking mode is enabled. Pressing the soft key when this icon is displayed will deactivate loudspeaking mode.</p>
	<p>Sound off Shown when the  key is pressed and held, or when the phone is placed in the charger with sound off enabled.</p>
	<p>Microphone off Indicates a silenced microphone. It is displayed after a long press on  during a call.</p>
	<p>Headset Indicates that a corded headset is connected to the phone.</p>
	<p>Outgoing call Added in front of outgoing calls in the call list.</p>
	<p>Incoming call Added in front of all answered calls in the call list.</p>
	<p>Missed call Added in front of missed calls in the call list, and in the status bar.</p>

Icon (Cont.)	Description (Cont.)
	<p>Voice mail message Appears in the inbox when there are voice mail messages that you have not listened to. The icon remains in the inbox until you have listened to the voice mail.</p>
	<p>New voice mail message Indicates that you have one or more new voice mail messages. The icon remains in the status bar until all voice mail messages have been listened to.</p>
	<p>New text message Indicates that you have one or more new text messages. The icon remains in the status bar until all new text messages have been read.</p>
	<p>Read message Placed in front of a message to indicate that this message has been read.</p>
	<p>Keys locked Indicates a locked keypad.</p>
	<p>Phone locked Indicates a locked phone.</p>
	<p>Locked entry Indicates a company phonebook contact. These contacts cannot be changed or deleted by the user.</p>
	<p>Bluetooth Indicates that Bluetooth is enabled.</p>
	<p>Bluetooth headset Indicates that a Bluetooth headset is connected to the phone.</p>
	<p>WinPDM/CPDM communication Visible when there is communication with WinPDM or CPDM through the desk PDM charger.</p>

3.2.4



Menu Tabs

The menu tabs are listed and described below.

Icon	Description
	<p>Contacts</p> <p>Contains all names and numbers in the local phonebook. In addition, a company phonebook with up to 1,000 entries can be downloaded from the WinPDM or CPDM to the phone. It is also possible to access a central phonebook from this menu.</p> <p>Company phonebook and central phonebook are system dependent and configured by the system administrator.</p>
	<p>My favourites</p> <p>Contains menu shortcuts that you use to customize the menus.</p>
	<p>Messaging</p> <p>Contains all message handling such as reading and writing messages.</p>
	<p>Calls</p> <p>Contains call lists, call time, and call services</p> <p>Call services are configured by the system administrator from the WinPDM or CPDM.</p>
	<p>Connections</p> <p>Contains Bluetooth connection, headset selection, system selection and In charger selection.</p> <p>Bluetooth is optional, and is only visible in the connections menu if Bluetooth is ordered with the phone.</p>
	<p>Settings</p> <p>Contains phone settings such as ringer volume, and display language.</p>
	<p>Short cuts</p> <p>Contains shortcuts for the soft keys, hot keys, navigation keys, and the multifunction button.</p>
	<p>Profiles</p> <p>Allows you to create up to four profiles. By default there is no profile.</p>

3.3 Menu Structure

All available phone features can be accessed through the menus. Use the navigation key, , to enter menus, to select options, and confirm selections.

- In idle mode, press the middle key of  to open the main menu.
 - Note:** You can also open the main menu by pressing **Menu**.
- To confirm a selection, press the middle key of .
 - Note:** You can also confirm a selection by pressing **Select**.
- Press **Back** to return to the previous menu, and press  to exit the menu structure.

When you open the main menu, the display will look as in figure 4 on page 23. The Messaging icon is selected by default when the main menu opens.

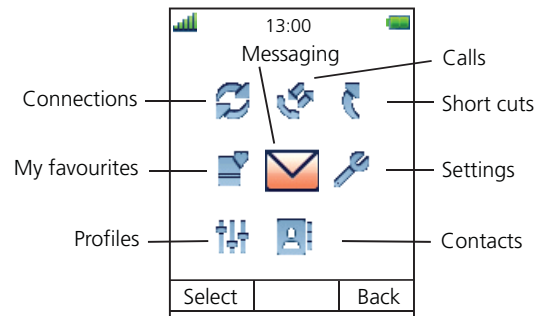

Figure 4: The main menu with the Messaging icon selected

Note: The phone can be used in several networks. All functions are not supported in all networks.

3.3.1

Calls Menu

An overview of the **Calls** menu  is presented in figure 5 on page 24.

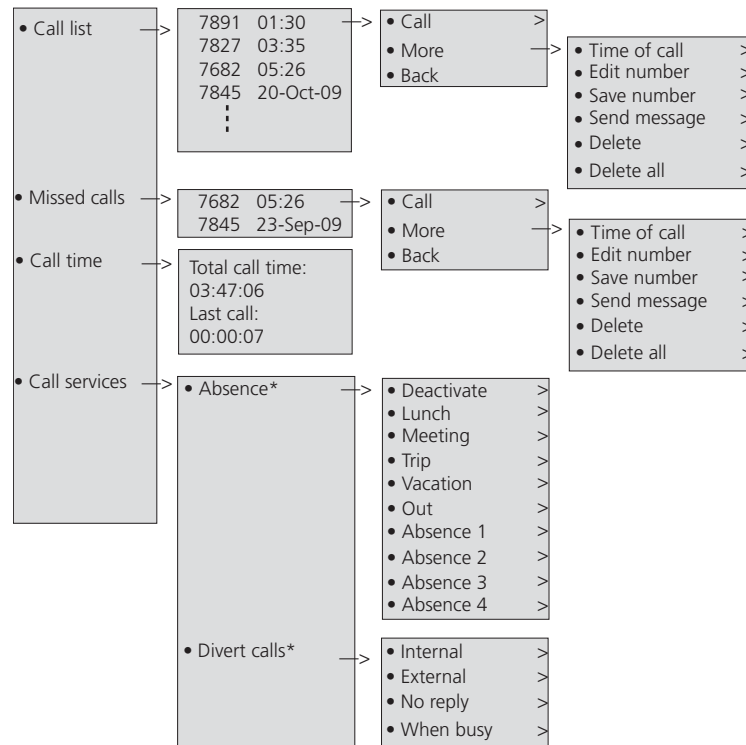

* Visible if defined in the PDM

Figure 5: Calls Menu

Note: Call service functions are system dependent. Parameters are set up in the CPDM or WinPDM. Contact the system administrator.

3.3.2 Contacts Menu

An overview of the **Contacts** menu  is presented in figure 6 on page 25.

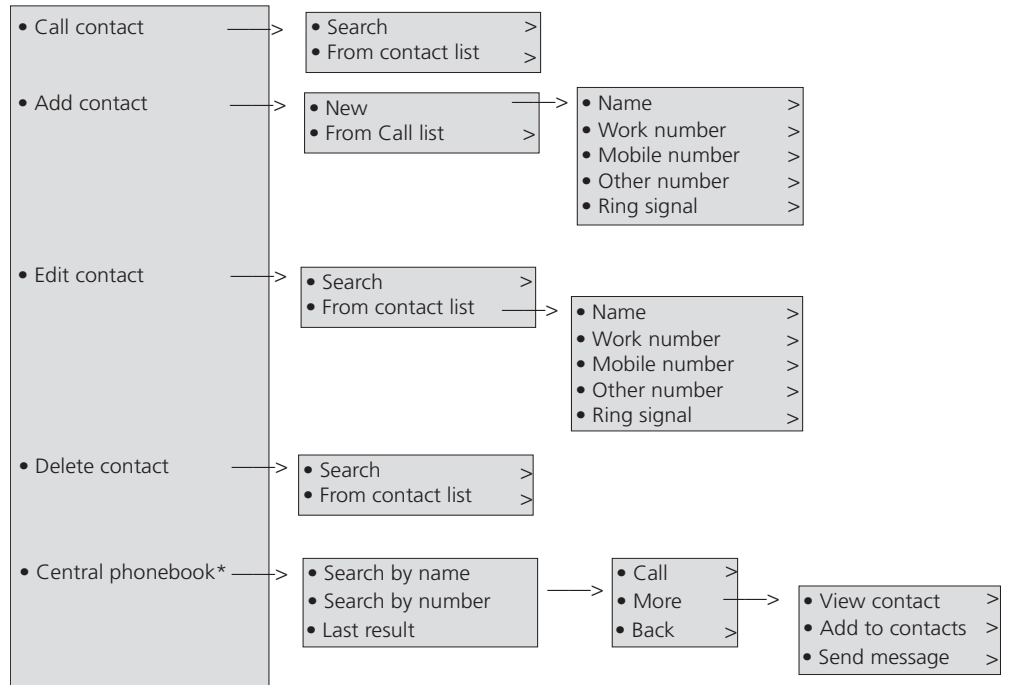

* System dependent

Figure 6: Contacts Menu

3.3.3 Profile Menu

An overview of the **Profile** menu  is presented in figure 7 on page 25.

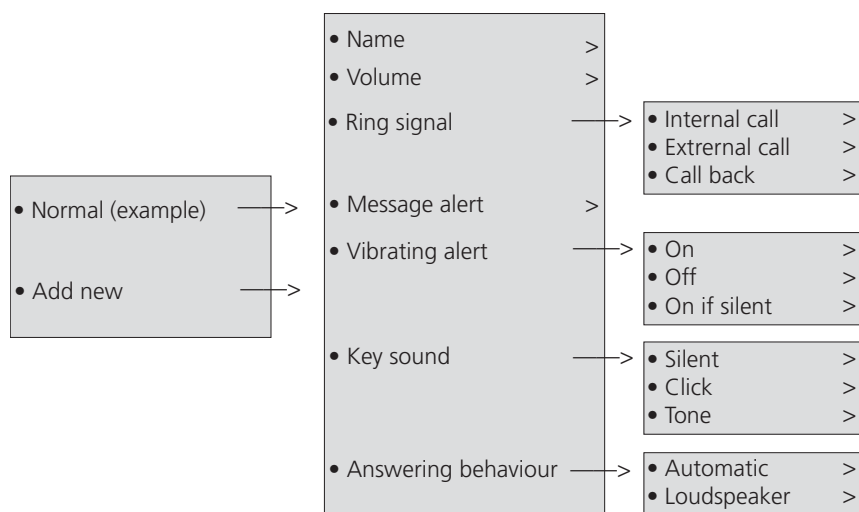

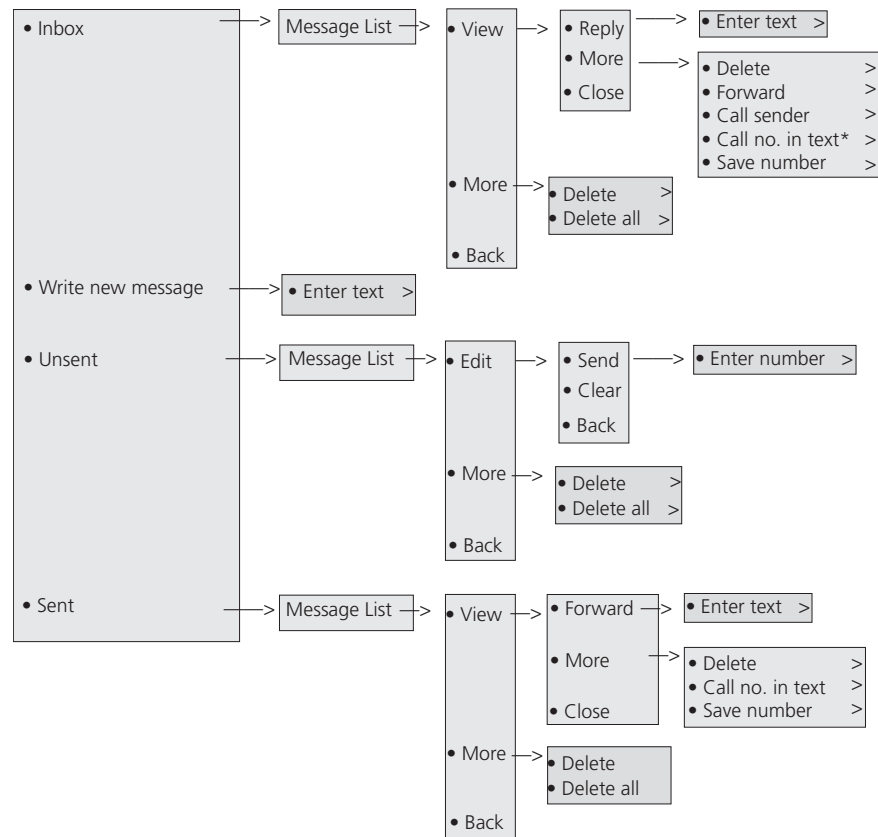

Figure 7: Profile Menu

3.3.4

Messaging Menu

An overview of the **Messaging** menu  is presented in figure 8 on page 26.



*) Visible if the number consists of minimum 3 digits.

Figure 8: Messaging Menu

3.3.5 My Favourites Menu

An overview of the **My favourites** menu  is presented in figure 9 on page 27.

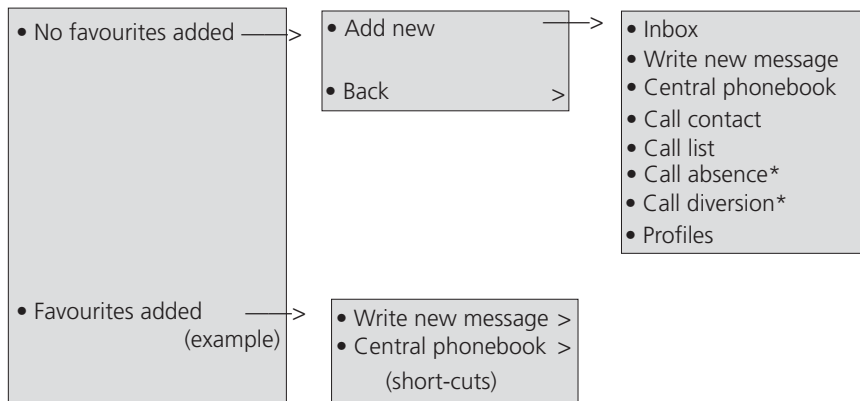

* Defined in the PDM

Figure 9: My favourites Menu

3.3.6 Short cuts Menu

An overview of the **Short cuts** menu  is presented in figure 10 on page 27.

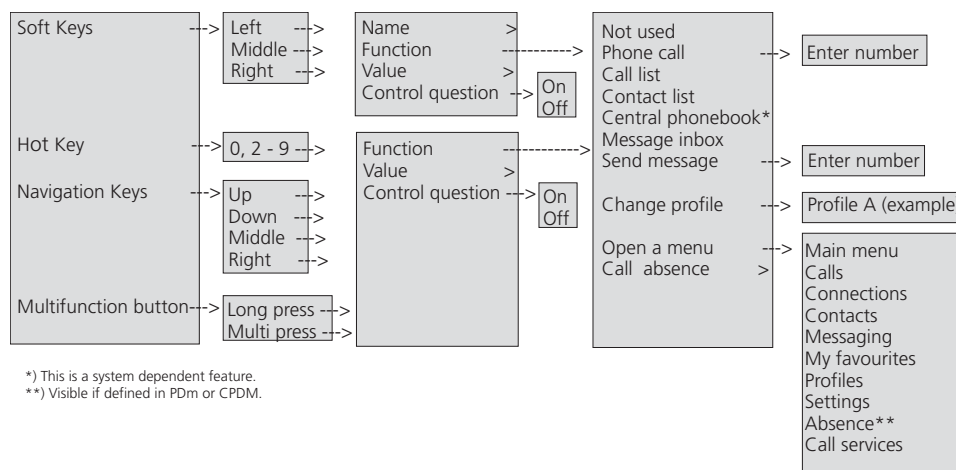

*) This is a system dependent feature.
 **) Visible if defined in PDM or CPDM.

Figure 10: Short cuts Menu

3.3.7

Connection Menu

An overview of the **Connection** menu  is presented in figure 11 on page 28.

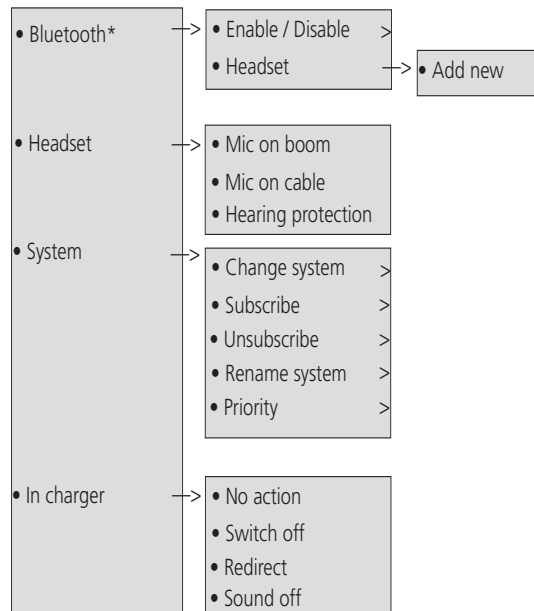

*) Visible if the telephone's hardware supports Bluetooth

Figure 11: Connection Menu

3.3.8 Settings Menu

An overview of the **Settings** menu  is presented in figure 12 on page 29.

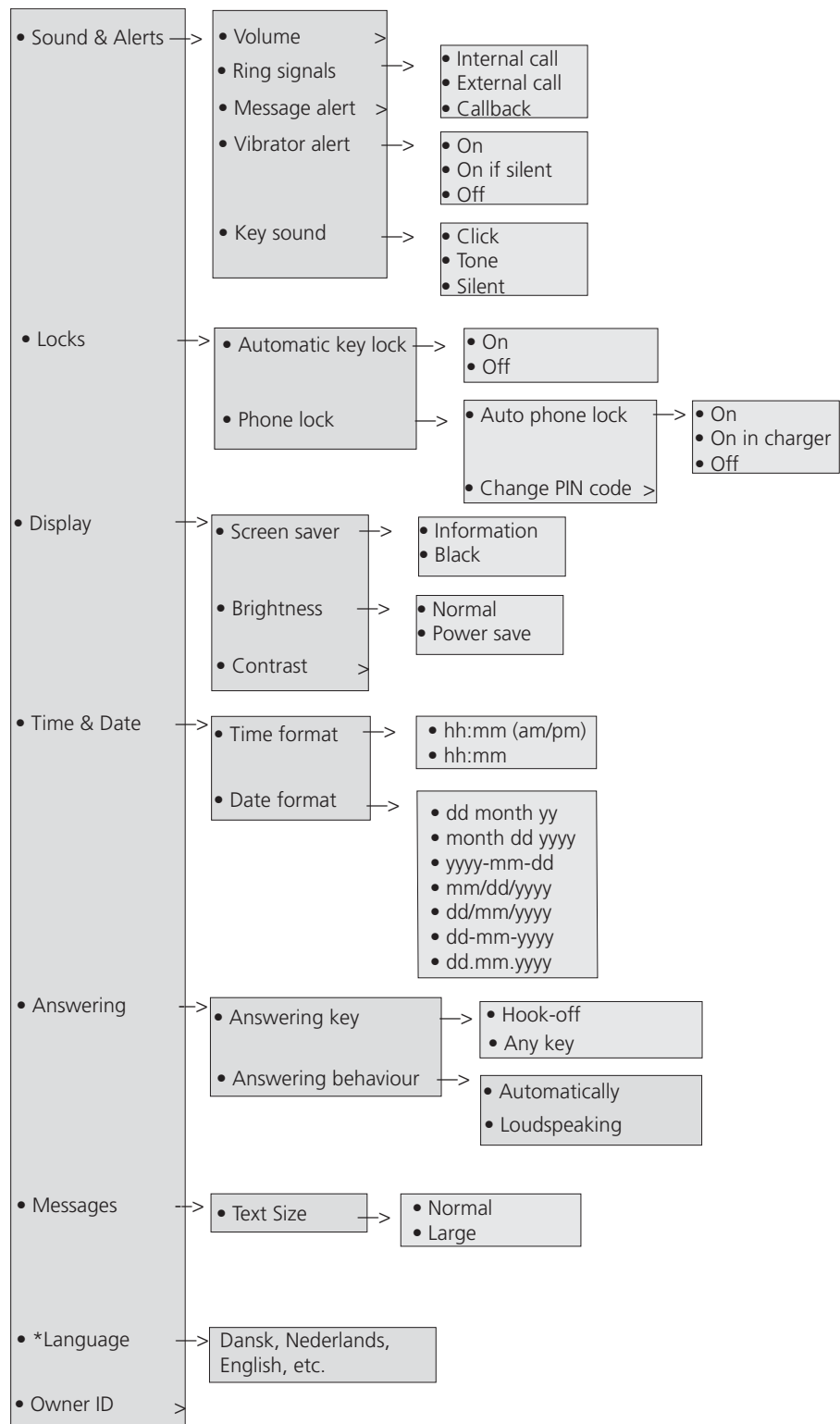

Figure 12: Settings Menu

3.3.9

In Call Menu

An overview of the **In call** menu is presented in figure 13 on page 30. You reach the menu by pressing the soft key **More** during a call.

Note: The options that appear when you press **More** are programmed from the WinPDM or CPDM. Please contact the system administrator.

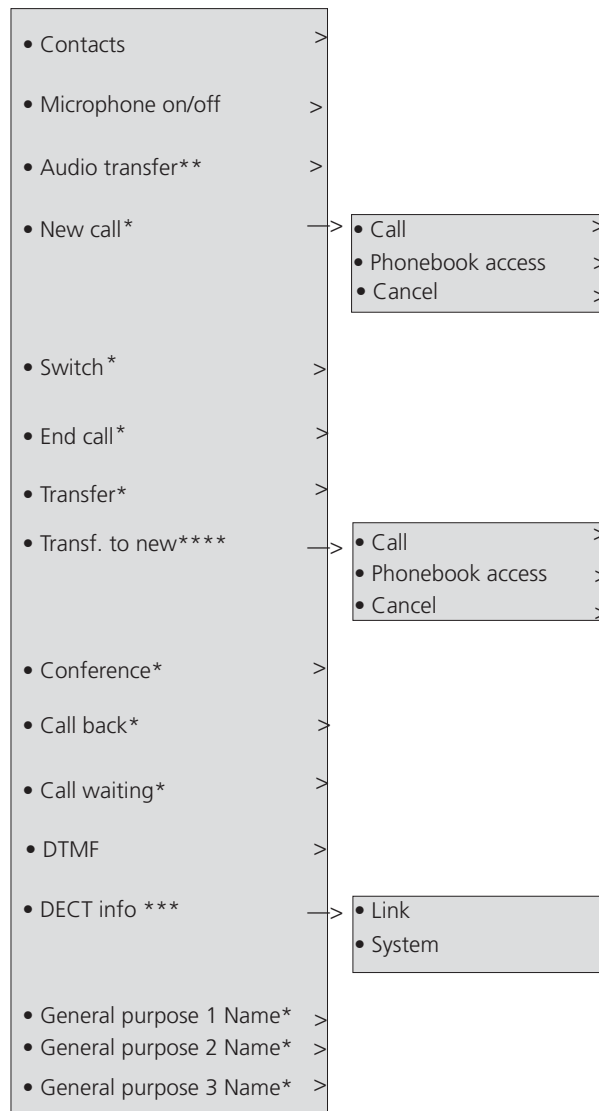

* Visible if defined in the PDM

**Only available when Bluetooth connection is active.

*** Visible if the Admin menu is activated.

**** Visible if the parameters "New call" and "Transfer" are defined in the PDM.

Figure 13: In call Menu











3.3.10 Customizing the Menu Structure

It is possible to customize the menu tree by hiding some of the available functions that for example are not in use. This is configured in the WinPDM or CPDM by the system administrator.

3.4

Tones

The following different tones are sent from the exchange to your phone.

Tone	Description
Dial tone	
Special dial tone	
Ringing tone or queue tone	
Busy tone	
Congestion tone	
Number unobtainable tone	
Call waiting tone	
Intrusion tone	
Conference tone	 every 15 seconds (to all parties)
Verification tone	
Warning tone, expensive route	

3.5 Indicators

3.5.1 Phone Indicator

The status indicators listed below are used to indicate phone status.

Table 3 Cordless Phone Indicator

Indicator	Description
Orange, fixed (phone placed in charger)	Battery is being charged.
Green, fixed (phone placed in charger)	Battery is fully charged.
Red, fixed	Battery warning.
Green flashing	Incoming call.

3.5.2 Desk PDM Charger Indicator

The status indicators listed below are used to indicate charger status.

Table 4 Desk PDM Charger Indicator

Indicator	Description
None	Not connected to power.
Green, fixed	Logged on to CPDM or WinPDM.
Orange, fixed	Not logged on to CPDM or WinPDM.
Orange, flashing (1000 ms on, 1000 ms off)	Software download File transfer during Easy Replacement
Orange, flashing (100 ms on, 800 ms off)	Change phone indication during Easy Replacement.
Red, fixed	Software error. Service needed.

Red, flashing (100 ms on, 800 ms off)	Error indication during Easy Replacement. Put back old phone in charger. Charger returns to Not logged in to CPDM or WinPDM mode when the phone is removed.
Red, flashing (3 long flashes, 800 ms on, 100 ms off)	Parameter error in user parameters. Charger performs a factory reset and restarts.
Red, flashing (800 ms on, 100 ms off)	Parameter error in production parameters. Service needed for charger. Error during Easy Replacement. Service needed for both phones.

4 Switching On and Off

This chapter describes how to switch on and off the phone.

Note: If the message `No System` is displayed you cannot make or answer calls. Depending on system programming, your phone can be locked automatically. To unlock the phone, enter your four digit code (factory default is "0000").

4.1 Switching On

To switch on the phone, do the following:

1. Press and hold .

The phone will vibrate when it is on and the display lights up. The following confirmation message is displayed: `DT690 Switch on?.`

2. Press **Yes** to confirm.

If the phone does not switch on, or if the battery icon indicates low level, charge the battery and try again.

4.2 Switching Off

To switch off the phone, do the following:

1. In idle mode, press and hold .

The following confirmation message is displayed: `Switch off?.`

2. Press **Yes** to confirm.

The phone is switched off.

Note: Pressing  from a menu will return you to idle mode.

5 Free Seating

Free Seating is used for people who have an office extension number but no phone set of their own, for example, people who are mostly working outside the office. As a free seating user, and working from the office, you can log on to any free phone set. The phone set will be assigned temporarily with your extension number and your system authorities.

Note: Free seating is not supported by IP DECT.

5.1 Logging On

To log on, do the following:

1. Press ***11***.
2. Dial the *authorization code * extension number #* and press .

Wait for the call timer to start in the display.

3. Press  to finish the procedure.

The display shows your phone number.

5.2 Logging Off

To log off, do the following:

1. Press **#11#** and then .

Wait for the call timer to start in the display.

2. Press  to finish the procedure.

6 Incoming Calls

An incoming call is indicated by a flashing indicator, accompanied by a ring signal and a vibrating phone. The ring type tells you if the call is an internal, external or callback call. Both ring signal and vibrator can be disabled. The calling party's number or name, or both, is displayed.

The name of the caller will be shown if the calling party's phone number is stored in any of the phonebooks. When a headset is connected to the phone, the answering button on the headset can be used to answer the call.

The 25 last received phone numbers are stored in the call list along with the latest dialed and missed phone numbers, see Call List on page 51.

6.1 Answering Calls

When you receive a call, do the following to answer:

- Press .

OR

- Press  to answer in loudspeaking mode (handsfree).

You are connected to the caller via the loudspeaker.

OR

- Press the answering button on the headset.

Note: Calls can be answered at any time even during programming, or while keying in a number. When the phone is in idle mode, you can change the answering method, see Changing Answering Methods on page 106.

Other answering methods, such as Automatically or Loudspeaking, can be set from the **Settings** tab, , see Settings on page 100. When automatic answering is enabled, an incoming call will be answered automatically after approximately one second.

6.1.1 Call Pick-up

To answer a call to a phone in another room:

1. Call the ringing extension and press .
2. When you hear a busy tone, press **8**.

Note: France and New Zealand press **4**; Sweden press **6**.

6.1.2 Mute Ring Signal

If the phone rings at an inconvenient moment, you can switch off the ring signal temporarily:



1. Press  to suppress the ringing.

All alert signals, including the vibrator, will be muted for this specific call.

2. Press  to answer the call.

6.1.3 Silent Ringing

You can set your phone to silent ringing, when your phone is in idle mode:

- Press and hold  to switch the ring signal on or off. When the ring signal is switched off, the icon  is shown. All alert signals will be silent until the ring signal is switched on again. If the vibrator is set to **On when silent**, it will alert you of new calls, messages and alarms. See Switching Vibrator On and Off on page 100.

6.2 Rejecting a Call

If you do not want to answer an incoming call, you can reject the call:

- Press . The call is disconnected.

6.3 Ending a Call

If you want to end an ongoing call, you hang up:

- Press .

The display shows the duration of the call. The total time of the call can also be retrieved from the **Calls** menu.

6.4 Parallel Ringing

Parallel ringing makes it possible for an incoming call to ring several phones simultaneously and for the call to be answered from any of the phones. The main advantage of this function is minimizing the risk of losing calls. The function requires all the phones involved to be defined in a parallel ringing list, which must be configured and initiated by the system administrator.

Because only calls to a main extension will be distributed among the phones in the list, this main extension also needs to be defined. A call to a specific extension will not be distributed to other phones in the list. The user can disable parallel ringing temporarily using the function Internal Follow-me. For more information about Internal Follow-me, see Internal Follow-me on page 72.

6.4.1 Disabling Parallel Ringing Temporarily

To disable parallel ringing temporarily, do the following:

1. Press ***21***

Note: U.K., press ***2***.

2. Dial the *extension number*, press **#** and press .

Wait for the call timer to start in the display.

3. Press  to finish the procedure.

If you want to disable parallel ringing for all phones defined in the list, follow the procedure for disabling the function from the phone with the main extension number and enter the number of the answering position. If you want to disable parallel ringing for one specific phone in the list only, follow the procedure for disabling the function from this phone and enter its extension number.

6.4.2 Restoring Parallel Ringing

To restore parallel ringing, do the following:

1. Press **#21#**.

Note: U.K., press **#2#**.

2. Press .

Wait for the call timer to start in the display.

3. Press  to finish the procedure.

Note: If you want to restore parallel ringing for all phones defined in the list, follow the procedure for restoring the function from the phone with the main extension number and enter the number of the answering position. If you want to restore parallel ringing for one specific phone in the list only, follow the procedure for restoring the function from this phone and enter its extension number.

7 Outgoing Calls

This chapter describes how to make calls, how to conceal your number from being displayed to the person you are calling, and how to redial the last external number dialed.

7.1 Calling

To make a call, you can either select a contact in one of the phonebooks available, or get the phone number or extension from the call list. You can also use shortcuts, if available.

- Available phonebooks are the local phonebook stored on the phone and the company phonebook stored centrally on a server, see **Contacts** on page 53.
- The 25 last received phone numbers are stored in the call list along with the latest dialed and missed phone numbers, see **Call List** on page 51.
- It is possible to save a phone number as a shortcut, see **Shortcuts** on page 59.

If the number you wish to dial is not stored in any phonebook, nor found in the call list, you enter the desired phone number or extension with the keypad.

To call a number that is not stored in the call list or among your contacts, do the following:

1. Dial the number and press  or **Call**.

The number is shown on the display while dialing.

2. If needed, press **Clear** to erase and edit the number.

Use the navigation key to step and add or delete a digit in the middle of a number.

Note: If you receive a queue tone when the digit(s) to get an external line are dialed (if the feature Least Cost Routing is used in the system), keep waiting. Once a line becomes free you will receive a dial tone. If a warning tone is heard, the selected line is marked **Expensive**.



7.1.1 Dialing Using a Pre-programmed Hot Key or Soft Key

To dial using a hot key or soft key, do the following:

- Press the pre-programmed hot key or soft key.
The call will be connected automatically.



7.1.2 Dialing a Number From the Call List

To dial a number stored in the call list, do the following:

1. Press .
The call list is opened. If a number occurs more than once, the most recent time stamp is shown along with the total number of occurrences.
2. Step with the navigation keys in the call list and select a number to dial. If you wish to edit the number before calling, do the following:
 - a) Press **More**.
 - b) Select **Edit number**, press **Select**, and make the desired changes.
3. Press  or **Call**.

7.1.3 Dialing From Contacts

To dial a contact, do the following:

1. Press **Menu**, select , and press **Select**.
2. Select **Call contact**, and press **Select**.
A name list is shown.
3. Select a contact from the list, or search a name or number by enter characters in the **Search** field, and press  or **Call**.

For more information about calling contacts via the phonebooks, see Contacts on page 53.

7.1.4 Dialing a Number from a Text Message

It is possible to dial a number included in a received text message. For detailed instructions, see Calling a Phone Number Included In a Message on page 88.

7.1.5 Loudspeaking (Handsfree)

While waiting for a connection, dial tone or during the call:

1. Press .
2. You are connected to the call via the loudspeaker and microphone.

7.2 Number Presentation Restriction

If you do not wish to display your name and number to the person you are calling, you can activate the number presentation restriction feature.

Note: The feature can be blocked for use on your extension by the system administrator.

To hide your name and number from the person you are calling, do the following:

1. Press ***42#** and press .

Wait for a dial tone.

2. Dial the number.

Instead of showing your name and number, the display on the called phone shows the text *Anonymous*.

Note: The number presentation restriction settings are valid only for the ongoing call. Next time you want to use the feature, you will have to activate it again.

7.3 Last External Number Re-dial

When you make an external call, the system automatically stores the number dialed, regardless of whether the call was successful or not.

To re-dial the last external number dialed:

- Press *** and then .

Note: Finland and Sweden, press **0.

7.4 When You Receive a Busy Tone

If you call an extension and receive a busy tone or get no answer, or if all external lines are busy, you can use one of the following methods:

- Callback
- Call Waiting
- Intrusion

Note: These functions need to be programmed via the WinPDM or CPDM. Please contact the system administrator.

During an ongoing call, the soft key **More** is displayed, leading to the **In call** menu, where you find options such as **Callback** and **Call waiting**.

7.4.1 Callback

When you order callback for a busy extension, you will be called back as soon as the extension or line becomes free. If you order callback when there is no answer, you will be called back when the extension has been used the next time.

7.4.1.1 Ordering Callback for an Extension

To initiate callback when a called extension is busy, or when there is no answer, do the following:

1. Press **More**.
2. Select **Callback**, and press **Select**.

Note: If **Callback** is not programmed and does not appear when you press **More**, you can press **6** to initiate callback. France, New Zealand and Sweden, press **5**

3. Press  and wait until the phone alerts.

You are called back (recall ring signal) when the ongoing call is finished or the next time a new call is finished. You have to answer within eight seconds, otherwise the callback service is cancelled. While waiting for callback, you can make and receive calls as usual.

4. Press  to answer when you are called back.

The system calls the extension.

Note: Callbacks can be activated on several extensions at the same time.

7.4.1.2

Ordering Callback for an External Number

If all external lines are busy when you have dialed the external number and pressed , do the following:

1. Press **6#**.

Note: France, New Zealand and Sweden, press **5#**.

2. Press  to finish the procedure.

When an external line becomes free you will be called back (recall ring signal). You have to answer within eight seconds, otherwise the callback service is cancelled. While waiting for callback, you can make and receive calls as usual.

3. Press .

The system calls the external number.

Note: Only one callback can be activated on a busy external line.

7.4.1.3

Canceling a Single callback

To cancel a callback, do the following:

1. Press **#37***.

Note: U.S. and Canada, press **#6***.

2. Dial the *extension number* and press **#**.

Note: To cancel a single callback on a specific external line, dial the digit or digits to get a line instead of the extension number.

3. Press .

Wait for the call timer to start in the display.

4. Press  to finish the procedure.

7.4.1.4 Canceling All Callbacks

To cancel all callbacks, do the following:

1. Press **#37#**.

Note: U.S. and Canada, press **#6#**.

2. Press .

Wait for the call timer to start in the display.

3. Press  to finish the procedure.

7.4.2 Ordering Call Waiting

If you urgently wish to contact a busy extension or external line, you can send a notification using a call waiting signal.

Note: This feature might be blocked for use on your extension. This needs to be configured in the WinPDM or CPDM by the system administrator.

To order call waiting, do the following:

1. Press **More**, select **Call Waiting** and press **Select**.

The other part will hear a call waiting signal.

Note: If **Call Waiting** is not programmed and does not appear when you press **More**, you can press **5** to activate. France and New Zealand, press **6**; Sweden, press **4**.

2. Keep the phone off hook but close the menu.
3. When the called extension or external line becomes free, it will be called automatically.

7.4.3 Intrusion

You can intrude on an ongoing call on a busy extension. If intrusion is not allowed for the called extension, you will continue to hear a busy tone. Before the intrusion is executed, an intrusion tone is sent to the parties in the ongoing call. As long as the three parties are connected, you will hear an intrusion tone.

Note: Intrusion might be blocked for use on your extension (this is programmed by the system administrator). If Intrusion is not allowed, you will continue to hear a busy tone.

7.4.3.1 Ordering Intrusion On a Busy Extension

To intrude on a busy extension, do the following:

1. Press **4** when you hear a busy tone.

Note: France, New Zealand and Sweden, press **8**.

7.5 Bypass

If you need to get through to a certain extension that is currently being forwarded by follow-me, you can bypass the extension.

If this feature is allowed from your extension, you can bypass an activated Diversion, an activated Follow-me or an activated Absence Information on a specific extension.

To request a bypass ordered by an extension, do the following:

1. Press ***60***.

Note: U.S. and Canada, press ***1***.

2. Dial the *extension number* and press **#** and .

Wait for an answer.

7.6 Speed Dialing

Common speed dialing numbers allows the you to make calls simply by pressing a few keys. The common speed dialing numbers consist of 1-5 digits and are stored in the exchange (by the system administrator).

To make call using a speed dial number, do the following:

1. Dial the common *speed dialing number*.

Please see to your phone directory.

2. Press  to make the call.

Note: You can also make speed dialing calls via the phonebook.

7.7 Voice Dialing

The phone is prepared for the Voice Activated Assistant feature, which can be programmed via CPDM or WinPDM on a hot key, soft key or the multifunction key. For more information, contact the system administrator.

7.8 Authorization Codes

Authorization codes are used to grant different user groups different levels of access to the telephony system.

There are two types of authorization codes, common and individual, which are presented in the following sections.

7.8.1 Common Authorization Code

If you are assigned to use a *common authorization code* (1 to 7 digits) you can change temporarily any phone used within the exchange to the authority level connected to this code. You can use the code for one call only or you can open the phone for some calls and lock it when leaving the phone.

7.8.1.1 Opening the Extension For a Single Call

To use the code for a single call, do the following:

1. Press ***72***.

Note: Germany, The Netherlands, and Sweden, press ***75***. U.S. and Canada, press ***6***.

2. Enter the *authorization code*, press **#** and .

Wait for a verification tone.



3. Dial the digit(s) to get an external line.
4. Dial the external number.

7.8.1.2 Opening the Extension For Several Calls

To open an extension for some calls, do the following:



1. Press **#73***.

Note: U.S. and Canada, press **#71***.

2. Enter the *authorization code*, press # and .
- Wait for a verification tone.
3. Press  to finish the procedure.

7.8.1.3 Locking the Extension

To lock an extension, do the following:



1. Press ***73***.
Note: U.S. and Canada, press ***71***.
2. Enter the *authorization code*, press # and .
- Wait for a verification tone.
3. Press  to finish the procedure.

7.8.2 Individual Authorization Code

If you are assigned to use an *individual authorization code* (1 to 7 digits, assigned to your own extension), you can lock your own extension to a common authority level when, for example, you are out of the office. You can also change temporarily any other phone used within the exchange to the same authority level as you have on your own phone. The individual code can be changed from your own extension.

7.8.2.1 Locking the Phone

To lock your phone, do the following:

1. Press ***76***.
2. Enter the *authorization code*, press # and .
- Wait for a verification tone.
3. Press  to finish the procedure.

7.8.2.2 Making Calls While the Phone Is Locked

To make calls with your authority level when your phone is locked, do the following:

1. Press ***75***.
Note: Germany, The Netherlands, and Sweden, press ***72***.
2. Enter the *authorization code*, press # and .



Wait for a verification tone.

3. Dial the digits to get an external line and the external number.

7.8.2.3

Opening the Phone

To open your phone, do the following:

1. Press **#76***.
2. Enter the *authorization code*, press **#** and .
3. Press  to finish the procedure.

7.8.2.4

Assigning Own the Individual Authorization Code to Other Phone



To assign your own authority level to another phone, do the following:

1. Press ***75***.
Note: Germany, The Netherlands, and Sweden, press ***72***.
2. Enter the *authorization code* and press *****.
3. Dial your own *extension number*, press **#** and .
Wait for a verification tone.
4. Dial the digits to get an external line and the external number.

7.8.2.5

Changing the Individual Authorization Code

To change your individual *authorization code*, do the following:

1. Press ***74***.
2. Enter the old *authorization code* and press *****.
3. Enter the new *authorization code*, press **#** and .
Wait for verification tone.
4. Press  to finish the procedure.

8 Call List



The 25 last received, dialed and missed calls are stored in a call list. The numbers can be either extension numbers or external numbers, and External numbers are preceded by the digit(s) for external call access. If supported by the system, the number's contact name can be displayed in the call list.

If the same number is received, dialed or missed several times, it appears only once in the call list. However, next to the number, a time stamp for the most recent call is displayed along with information about the total number of calls to or from that number.

If the time and date feature is enabled, it is possible to see when calls were made or received that day. The following day, the time stamp is changed to a date stamp. For more information on time and date settings, see Time and Date on page 102.

8.1 Opening the Call List

To open the call list, do the following:

1. Press **Menu**, select , and press **Select**
 - Note:** You can also open the call list by pressing .
2. Select **Call list**, and press **Select**.
3. Scroll the list to select a number to call or edit.
4. Select **More** or **Call**.
 - Pressing **Call** initiates a call to the selected number.
 - Pressing **More** opens a menu with options to edit, save, or delete calls, to view the time of stamp of the selected call, or to send a message to it.
5. Press **Back** to leave the call list.

8.2 Saving a Number in the Call List

To edit a number in the call list, when your phone is in idle mode, do the following:

1. Press **Menu**, select , and press **Select**.
2. Select **Call list**, and press **Select**.
3. Scroll the list to select a number to edit.
4. Select **More** and **Edit number**.
5. Press **Save number**, specify the type of number, and press **Select**.
The number is saved and the name field is highlighted.
6. Press **Add**, enter the desired name and press **OK**.
7. Make any other necessary settings and press **Save** and then press **Back** twice to leave the call list.

8.3 Deleting a Number From the Call List

To delete a number from the call list, when your phone is in idle mode, do the following:

1. Press **Menu**, select , and press **Select**.
2. Select **Call list**, and press **Select**.
3. Scroll the list to select a number and press **More**.
4. Select **Delete**, and press **Select** to remove the selected number.
Select **Delete all**, and press **Select** to remove all numbers in the call list.
5. Press **Yes** to confirm.

The name and number are deleted.

9 Contacts

The phone is equipped with the following phonebooks:

Local phonebook

The local phonebook can hold up to 250 entries (that is, names and numbers), which can be added, deleted and edited by the user. The phonebook lists all names in alphabetical order, where three numbers can be added for each contact; work number, mobile number, and other number. Maximum name and number length is 48 characters in name and 24 digits in a number.

Company phonebook

The company phonebook can hold up to 1,000 entries, which can be downloaded to the phone. The names and numbers in this phonebook cannot be edited or deleted by the user. The phonebook lists all names in alphabetical order. The names from the local phonebook and the company phonebook appear in the same list, but the company phonebook contacts are marked with  in front of the name to indicate that they cannot be modified. Maximum name and number length is 24 characters in name and 24 digits in a number (1 number per name).

Central phonebook (optional)

When you access the central phonebook, you send a request to a messaging server with the first characters entered, and the messaging server returns a list of names that matches the search. Maximum name and number length is 40 characters in name and 20 digits in number.

9.1 Dialing a Contact from the Local or Company Phonebook

To dial a contact from the company phonebook, do the following:

1. Press **Menu**, select , and press **Select**.
2. Select **Call contact**, and press **Select**.

The local and company phonebook contacts appear in the same list but the company phonebook contacts are marked with  in front of the name.

3. Select a contact from the list, or search a name or number by entering characters in the **Search** field, and press **Call**.

9.2 Dialing a Contact from the Central Phonebook (Optional)

In the central phonebook, it is possible to search by name, number, or the last result.

When the search is finished, it is possible to view contact information, add the number to a new contact, and to call the number.

9.2.1 Searching by Name

To search a central phonebook contact by name, do the following:

1. Press **Menu**, select , and press **Select**.
2. Select **Central Phonebook**, and press **Select**.
3. Select **Search by name**, and press **Select**.
4. Enter the first or last name and press **Search**.

The status message *Searching* is displayed.

5. Press  or **Call**.

9.2.2 Searching by Number

To search a central phonebook contact by number, do the following:

1. Press **Menu**, select , and press **Select**.
2. Select **Central Phonebook**, and press **Select**.
3. Select **Search by number**, and press **Select**.
4. Enter the first digit in the number and press **Search**.

The status message *Searching* is displayed.

5. Select the number to call from the result list and press  or **Call** to make the call.

9.2.2.1 Adding a Contact from the Central Phonebook Search

When the search result is received, it is possible to add the name and number as a contact. Do the following:

1. Press **More**.
2. Select **Add to cont.** and press **Select**.
3. Press **Save**.

9.2.3 Viewing Last Search Result

To view the last search result:

1. Press **Menu**, select , and press **Select**.
2. Select **Central Phonebook**, and press **Select**.
3. Select **Last Result**, and press **Select**.

9.3 Adding a Name and a Number

To add a name and a number to the phonebook, do the following:

1. Press **Menu**, select , and press **Select**.
2. Select **Add contact** and press **Select**.
3. Select **New** or **From call list** and press **Select**.

If **New** is chosen:

- a) Press **Add**, enter the name, and press **OK**.
- b) Select **Name**, **Work number**, **Mobile number**, or **Other number**, and press **Add**.
- c) Enter the number and press **OK**.
- d) Press **Save**.

If **From call list** is chosen:

- a) Navigate to the desired number in the call list and press **Add**.
- b) Select **Work number**, **Mobile number** or **Other number**, and press **Select**.
- c) Select **Name** and press **Add**.
- d) Enter the name of the contact and press **OK** to save the entry.
- e) Press **Save**.

9.4 Changing a Name and a Number

To edit a name or number in your list of contacts, do the following:

1. Press **Menu**, select , and press **Select**.
2. Select **Edit contact** and press **Select**.

The names in the contact list are shown in alphabetical order. To search in the list, enter the first character(s) in the name, or step with the navigation key.

3. Select the contact to change, and press **Edit**.
4. Select what to edit for this contact (**Name**, **Work number**, **Mobile number** or **Other number**) and press **Edit** again.
5. Make the changes, and press **OK**.
6. Press **Save** to save the changes.

9.5 Deleting a Name and a Number

To delete a name and a number from your contacts, do the following:

1. Press **Menu**, select , and press **Select**.
2. Select **Delete contact** and press **Select**.

The names in the contact list are shown in alphabetical order.

- Navigate with the navigation key to the desired name or number.

OR

- Enter the first character(s) in the name and press **Search**.
3. Press **Delete** to delete the entry and confirm deletion by pressing **Yes**.

9.6 Writing Text and Numbers

This section explains how to write text and numbers, which is useful when you want to add a new entry in the phonebook, or send a text message.

To enter a name or number, use the following keys:

- Press ◀ or ▶ on the navigation key, , to move the cursor within the chosen row.
- Press **Clear** to correct a wrong entry.

To add, for example, the name *Smith* in the phonebook, do the following:

1. Press 7777 for *S*.



The marked character is selected after a time out or when another key is pressed.

2. Press 6 for *m*.
3. Press 444 for *i*.
4. Press 8 for *t*.
5. Press 44 for *h*.
6. Press **OK** when the name is complete.

9.6.1 Number Input Mode

- A short press on a key enter the digits **0 - 9** and the characters * and #.
- To add a plus sign (+) in the number for international calls, press **0** twice.

9.6.2 Text Input Mode

- A short press on a key **0-9** displays the first available character on that specific key. The marked character is selected after a time out, or when another key is pressed.
- To change to upper or lower case, press  before entering the character. The same key can also be used to display only digits.
- To add space in the text, press **0**.
- A long press on  displays special characters.

9.6.3

Special Characters

Use the keypad to enter letters and characters. Press a key once for the first letter or character, twice for the second, three times for the third, and so on. The most common letters are printed above each key on the phone. All the available letters and characters are shown in figure 14 on page 58.

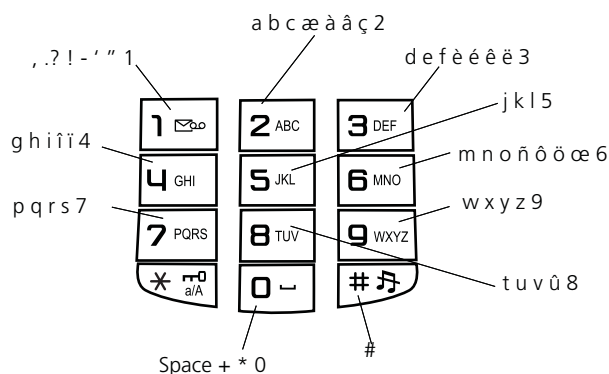



Figure 14: Available characters

Note: Depending on the selected menu language, other characters can be available than appear in the illustration above.

10 Shortcuts

From the **Short cuts** tab () you can create shortcuts to frequently used functions, such as making calls and sending messages. When you select , a list of available shortcut types is displayed. These shortcut types are: **Soft keys**, **Hot keys**, **Navigation keys**, and **Multifunction button**.

10.1 Soft Keys

There are three soft keys, located beneath the display. In idle mode, these keys can be used for functions defined by the user of the phone.

To assign a function to a soft key, do the following:

1. Press **Menu**, select , and press **Select**.
2. Select **Soft keys** and press **Select**.
3. Select **Left**, **Middle**, or **Right**, and press **Select**.
4. Select **Name** and press **Select**.

Enter a name for the soft key, and press **OK** to save the setting.

5. Select **Function** and press **Select**.
6. Select a function from the list, and press **Select**.
7. Press **Back** to confirm, or enter any required information, such as a phone number, and press **OK** to confirm.

Note: Depending on which function you select, you may need to enter more information or make more selections. If, for example, you select **Phone call** or **Send message**, you will be prompted for the phone number of whom to call or send a message to.

8. Select **Value** (if available for the selected function), press **Select**, enter a value and press **OK**.
9. Select **Control question**, and press **Select**.
10. Select **Off** or **On**, and press **Select** and then **Back**.

Note: The control question value is **Off** by default. If you select **On**, a control question *Proceed?* is displayed when you press and hold the soft key.

11. Press **Save**.

The message *Changes saved* is displayed.

10.2 Hot Keys

A hot key can be programmed to give access to frequently used functions such as dialling a specific phone number, a shortcut to the menu, or sending an SMS. Keys 0 and 2 - 9 can be assigned as hot keys.

To assign a hot key, do the following:

1. Press **Menu**, select , and press **Select**.
2. Select **Hot keys** and press **Select**.
3. Select a number (0 or 2-9) in the list and press **Select**.
4. Select **Function** and press **Select**.
5. Select a function from the list, and press **Select**.
6. Press **Back** to confirm, or enter any required information, such as a phone number, and press **OK** to confirm.

Note: Depending on which function you select, you may need to enter more information or make more selections. If, for example, you select **Phone call** or **Send message**, you will be prompted for the phone number of whom to call or send a message to.

7. Select **Value** (only available for some functions), press **Select** enter a value and press **OK**.
8. Select **Control question**, and press **Select**.
9. Select **Off** or **On**, and press **Select** and then **Back**.

Note: The control question value is **Off** by default. If you select **On**, a control question *Proceed?* is displayed when you press and hold the hot key.

10. Press **Save** to save the setting.

The message *Changes saved* is displayed.

10.3 Navigation Keys

The navigation key is really 5 separate keys; left, right, up, down, and confirmation (in the middle). You can define 4 of these navigation keys as shortcuts, that is, all except the middle key.

To assign functions to the navigation keys, do the following:

1. Press **Menu**, select , and press **Select**.
2. Select **Navigation keys** and press **Select**.
3. Select **Up**, **Down**, **Left**, or **Right**, and press **Select**.

4. Select **Function** and press **Select**.
5. Select a function from the list, and press **Select**.
6. Press **Back** to confirm, or enter any required information, such as a phone number, and press **OK** to confirm.

Note: Depending on which function you select, you may need to enter more information or make more selections. If, for example, you select **Phone call** or **Send message**, you will be prompted for the phone number of whom to call or send a message to.
7. Select **Value** (if available for the selected function), press **Select** enter a value and press **OK**.
8. Select **Control question** and press **Select**.
9. Select **Off** or **On**, and press **Select** and then **Back**.

Note: The control question value is **Off** by default. If you select **On**, a control question `Proceed?` is displayed when you press and hold the navigation key.
10. Press **Save**.

The message `Changes saved` is displayed.

10.4 Multifunction Button

The multifunction button can be defined with two different functions. A long press activates one function, and a double press activates another function. The key is not used by default, but can be defined by the user of the phone.

To assign functions to the multifunction button, do the following:

1. Press **Menu**, select , and press **Select**.
2. Select **Multifunction button**, and press **Select**.
3. Select **Long press** or **Multi press**, and press **Select**.
 - **Long press** means that you press and hold the multifunction button to reach the assigned function.
 - **Multi press** means that you press twice quickly on the multifunction button to reach the assigned function.
4. Select **Function** and press **Select**.
5. Select a function from the list, and press **Select**.
6. Press **Back** to confirm, or enter any required information, such as a phone number, and press **OK** to confirm.

Note: Depending on which function you select, you may need to enter more information or make more selections. If, for example, you select **Phone call** or **Send message**, you will be prompted for the phone number of whom to call or send a message to.



7. Select **Value** (if available for the selected function), press **Select** enter a value and press **OK**.
8. Select **Control question**, and press **Select**.
9. Select **Off** or **On**, and press **Select** and then **Back**.

Note: The control question value is **Off** by default. If you select **On**, the control question `Proceed?` is displayed when you press and hold the multifunction key.

10. Press **Save**.

The message `Changes saved` is displayed.

11 Favorites

From the **My favourites** tab () you can customize your own menu with frequently used functions. When you select  , a list of predefined functions is displayed, for example **Write new message**, **Central Phonebook**, and **Call list**.

11.1 Adding a Favorite

To add a new favorite, do the following:

1. Press **Menu**, select  , and press **Select**.
2. Select **Edit favourites**, and press **Select**.
3. Select one of the menu options and press **Change**.
4. Press **Back** to save the setting.

The message `Favourites saved` is displayed.

5. Press **Back** twice to return to the idle menu.

11.2 Deleting a Favorite

To delete a favorite, do the following:

1. Press **Menu**, select  , and press **Select**.
2. Select **Edit favourites**, and press **Select**.
3. Deselect the menu option you wish to delete, and press **Change**.
4. Press **Back** to save the setting.

The message `Favourites saved` is displayed.

5. Press **Back** twice to return to the idle menu.

12 During Calls

This chapter describes the options available during a call, such as call forwarding, call waiting, and conference. It also describes how to change the volume level and mute the microphone during a call.

12.1 Volume Control

To adjust the speaker volume during a call, you press the speaker volume up and speaker volume down buttons on the side of the phone. The phone stores and keeps the new volume level. You can also adjust the volume by pressing the navigation key.

12.2 Loudspeaking (Handsfree)

The loudspeaking function is useful in situations when you need to have a conversation over the phone while having your hands free for other tasks (handsfree mode).

To activate loudspeaking during a call, do the following:

- Press .

You are connected to the caller via the loudspeaker and microphone.

12.3 Muting the Microphone

It is recommended that you mute the microphone rather than putting a call on hold, because a call on hold can be diverted to your operator, directly or after some time.

To mute the microphone during an ongoing conversation, do the following:

1. Press **More**, select **Microphone off**, and press **Select**.

Or

Press and hold .

The mute microphone icon  is displayed, and the other part in an ongoing call will not be able to hear you.

To switch on the microphone again, do the following:

1. Press **More**, select **Microphone on**, and press **Select**.

Or

Press and hold .

Note: During an emergency call, the soft key **More** is disabled, which means that you can only turn off the microphone by pressing and holding .

12.4 Opening Contacts During Call

During a call it is possible to search for a contact in the local, the company and the central phonebooks.

To search a contact during a call, do the following:

1. Press **More**.
2. Select **Contacts**, and press **Select**.
3. Select **Call contact** to search a contact in the local or company phonebook. Or select **Central Phonebook** to search a contact in the central phonebook.
4. Press **Select**.
5. Select or search a contact.

Note: If you wish to call the selected contact, you press **Call**. Then the first call is put on hold. For more information, see Inquiry on page 65.

12.5 Inquiry

Inquiry means placing an ongoing call on hold, and then calling a new party.

Note: This feature needs to be configured in the WinPDM or CPDM. Please contact the system administrator.

To make an inquiry to a third party during an ongoing call, do the following:

1. Press **More** during the call.
2. Select **New call** and press **Select**.

Note: If **New call** does not appear when you press **More**, it is possible to press **R** and dial the third party to initiate the inquiry.

3. Dial the third party's phone number and press .

OR

Press the  soft key, select a contact, press **Select**, and then press **Call**.

Note: It is only possible to select a contact from the local and company phonebook, but not from the central phonebook, when making an inquiry.

4. When the third party answers, it is possible to switch between the calls (refer back), transfer the call, create a conference, and end one of the calls.

12.5.1 Ending Inquiry Call

When you want to end the inquiry call, do the following:

1. Press **More** during the call.
2. Select **End call** and press **Select**.

The third party is disconnected, and you are connected to the first party.

Note: If **End call** does not appear when you press **More**, press **R** to return to the first party.

12.5.2 Refer Back

When you have made an inquiry to another party, and want to switch between the calls, do the following:

1. Press **More**, select **Switch** and press **Select**.

Note: If **Switch** does not appear when you press **More**, press **2** to refer back. Sweden, press **R**.

12.6 Transfer

If you wish to transfer an ongoing call to another extension, you can use the transfer feature.

Note: This feature needs to be configured in the WinPDM or CPDM. Please contact the system administrator.

To transfer an ongoing call to another extension, do the following:

1. Press **More**, select **New call** and press **Select**.
2. Dial the third party and press .

You can dial the number, or use the phonebook or the call list to make the call.

3. Press **More**, select **Transfer**, and press **Select**.

The ongoing call is transferred.

Note: If **Transfer** does not appear when you press **More**, you can also do the following to transfer a call: Press **R**, dial the third party, and press  before or after the third party answers.

12.7 Blind Transfer

With the blind transfer feature, you can transfer a call directly to a third party, without having to wait for a ring tone when you dial the third party number. When the transfer is complete, you will be disconnected.

Note: This feature needs to be configured in the WinPDM or CPDM. Please contact the system administrator.

To transfer an ongoing call to a number that cannot be retrieved, do the following:

1. Press **More**, select **Transf. to new** and press **Select**.

Note: If **Transf. to new** does not appear when you press **More**, you can also do the following to transfer a call: Press **R**, dial the third party, and press  before the third party answers.

2. Dial the third party, and press .

12.8 Call Parking (On Hold)

An ongoing call can be put on hold temporarily. Calls put on hold can be resumed to your own or on another phone.

To put a call on hold, do the following:

1. Press **R**.

Wait for a dial tone.

12.8.1 Resuming a Call

To resume the call, do the following:

1. Press  within 30 seconds.

If not resumed within 30 seconds you will be called back. An unanswered external call will be rerouted to the operator after another 30 seconds.

12.8.2 Resuming a Call on Another Extension

To resume the call on another extension:

1. Call the extension where the call was put on hold and press .
2. Press **8**.

Note: France and New Zealand, press **4**; Sweden, press **6**.

12.9 Answering a Call Waiting Call

If you hear the call waiting tone during an ongoing conversation, another person is trying to contact you.

Note: If call waiting is not enabled for your extension, you will continue to receive a busy tone.

Before you answer a call waiting call, you can either terminate the ongoing call or put it on hold. Both methods are described below.

12.9.1 Putting the Ongoing Call On Hold

To put the ongoing call on hold and answer the waiting call, do the following:

1. Press **R**.

The ongoing call is put on hold and your phone rings to announce the waiting call.



Note: **R** is default for this function. If this soft key is reprogrammed to something other than **R**, this function is disabled.

2. Press  to finish the call.

Wait for the system to recall the first party.

12.9.2 Terminating the Ongoing Call

To terminate the ongoing call and answer the waiting call, do the following:

1. Press  to finish the ongoing call.
The waiting call is signalled on your phone
2. Press  to answer the new call.

12.10 Conference

The conference function allows up to 7 conference participants. Only the conference leader (that is, the person initiating the conference) can admit participants.

During the conference, a special tone will be heard every 15 seconds as a reminder of the ongoing conference. Each time a participant enters or leaves the conference, a burst tone is heard.

When the conference leader leaves the conference, the conference will continue with the other included parties. When only two participants are left, the conversation is changed back to a normal two party connection.

Note: This feature needs to be configured in the WinPDM or CPDM by the system administrator.

When you have an ongoing conversation and want to establish a phone conference, do the following:

1. Press **More**, select **New Call**, and press **Select**.

This will put the first call on hold.

2. Dial the number, and press .

When the third party has answered, continue with the following to establish a conference:

3. Press **More**, select **Conference** and press **Select**.

Note: If **Conference** does not appear when you press **More**, you can also do the following to establish a conference: Press **R**, dial the number to include, and press **3**.

4. Repeat the procedure to add more conference members.

12.11

Dialing During a Connected Call

When calling interactive teleservices, such as phone banks, you need to use Dual Tone Multi Frequency (DTMF) signals. If the phone exchange is not already programmed to automatically convert entered digits into DTMF signals, this function needs to be activated during the call.

To dial digits during a connected call, do the following:

1. Press **9**.

Note: In Finland, press **1**.

2. Dial the required digits.

The entered digits are transferred as DTMF signals.

OR

1. Press **More**, select **DTMF** and press **Select**.

2. Dial the required digits.

The entered digits are transferred as DTMF signals.

13 Call Forwarding

This chapter describes different ways of forwarding incoming calls to another internal or external destination whenever you are absent or busy, or travelling, or when you simply would rather not be disturbed.

13.1 Diversion from Call Services Menu

A soft key or a hot key can be pre-programmed with a shortcut to the Diversion function, see Shortcuts on page 59, or by setting the profile to divert incoming calls.



All calls to your extension can be diverted to an internal or external answering position of your choice, and calls to your extension can be diverted to other phone numbers when your extension is busy or when you are unable to answer.

Note: This feature needs to be programmed in the WinPDM or CPDM. Please contact the system administrator.

See also Internal Follow-me on page 72 and External Follow-me on page 73.

13.1.1 Ordering Diversion of Incoming Calls

To divert incoming calls to another phone number, do the following:

1. Press **Menu**, select  and press **Select**.
2. Step to **Call services**, and press **Select**.
3. Select **Divert calls** and press **Select**.
4. Select **Internal**, **External**, **No reply** or **When busy**, and press **Select**.
5. Select **Activate** and press **Select**.
6. Dial the number (maximum 24 digits) to divert your calls to and press **OK**. You can also press  to select a number from the call list.

Wait for the call timer to start in the display.

7. Press  to finish the procedure.

13.1.2 Canceling Diversion

To stop diversion, do the following:

1. Press **Menu**, select  and press **Select**.
2. Step to **Call services**, and press **Select**.
3. Select **Divert calls** and press **Select**.
4. Select **Internal**, **External**, **No reply** or **When busy**, and press **Select**.
5. Select **Deactivate**.

Wait for the call timer to start in the display.

6. Press  to finish the procedure.

13.2 Internal Follow-me

Internal Follow-me means that all calls to your extension are diverted to an extension of your choice (within the private network).

When **Follow-me** is enabled, the display shows the icon > after your number, and the number of the answering position. A special dial tone will be heard. The phone can still be used for outgoing calls. See also Diversion from Call Services Menu on page 71 and In Charger on page 112.

13.2.1 Ordering Internal Follow-me

To order internal follow-me, do the following:

1. Press ***21***.

Note: U.K., press ***2***.
2. Dial the *answering position number* and press **#** and .



Wait for the call timer to start in the display.
3. Press  to finish the procedure.

13.2.2 Cancelling Internal Follow-me

To cancel Internal follow-me, do the following:

1. Press **#21#**.

Note: U.K. press **#2#**.

2. Press .
Wait for the call timer to start in the display.
3. Press  to finish the procedure.

13.2.3



Remote Programming of Follow-me

Using remote programming of Follow-me, you can manage the Follow-me settings of other extensions besides the extension you are currently located at. You can, for example, activate Follow-me for extension 1234 while being located at extension 5678.

Follow the steps below to activate Follow-me for another extension:

1. Press **21* extension number to divert * internal number of follow-me position #*



Note: U.K: Press **2**.

2. Press  and wait for the call timer to start in the display.
3. Press .

Follow the steps below to terminate Direct diversion for another extension:

1. Press *#21* diverted extension number #*

Note: U.K: Press *#2**.

2. Press  and wait for the call timer to start in the display.
3. Press .

13.3

External Follow-me

External Follow-me means that calls to your extension can be diverted to an external number of your choice.

When external Follow-me is enabled, the display shows the icon > after your number. A special dial tone will be heard. The phone can still be used for outgoing calls. See also Diversion from Call Services Menu on page 71 and In Charger on page 112.



13.3.1

Ordering External Follow-me

To order external follow-me, do the following:

1. Press **22#*.

Note: U.S. and Canada, press *23#.

2. Dial the digit or digits to get a line, and enter the external number.
 3. Press # and .
- Wait for the call timer to start in the display.
4. Press  to finish the procedure.

13.3.2

Cancelling External Follow-me

To cancel external follow-me, do the following:

1. Press #22#.

Note: U.S. and Canada, press #23#.

2. Press .

Wait for the call timer to start in the display.

3. Press  to finish the procedure.

13.3.3



Remote Programming of External Follow-Me

Using remote programming of External follow-me, you can manage the External follow-me settings of other extensions besides the extension you are currently located at. You can, for example, activate External follow-me for extension 1234 while being located at extension 5678.

Follow the steps below to activate External follow-me for another extension:

1. Press *22* *extension number to divert* #



Note: U.S. and Canada: Press *23#.

2. Press *route access code and the external number* #
3. Press  and wait for the call timer to start in the display.
4. Press .

Follow the steps below to terminate External follow-me for another extension:

1. Press #22* *diverted extension number* #

Note: U.S. and Canada: Press #23#.

2. Press  and wait for the call timer to start in the display.
3. Press .

13.4 Personal Number

With the personal number feature you can be reached at your office number even if you are out of the office.

Depending on the functionality of your office exchange, you can have either one individual single search profile (standard) or choose between five individual search profiles (optional). A search profile can be designed for specific situations, such as in the office, at home, or on a trip. Both internal or external phone numbers can be used in a profile.

Your search profile is programmed or modified by the system administrator, see *Creating and Using Search Profiles* on page 77. When the personal number feature is activated, incoming calls are transferred to your selected phones or backup services in the order specified. If an answering position in the profile is busy, the call can be transferred to another predefined position in the profile. This can be either voice mail or a colleague, for example.

The profile can be handled from your own office phone, see the following sections for step-by-step descriptions. You can also have an operator assist you, or use any of the available personal assistant applications. For more information, contact the system administrator.

When you are out of the office, you can use the Direct Inward System Access (DISA) feature, if it is available in your system. How to use DISA is described in *Activating or Changing Personal Number From an External Phone* on page 76 and *Cancelling From External Phone* on page 77.

13.4.1 Activating or Changing Personal Number From Your Office Phone

To activate the personal number feature, or change to another profile from your office phone, do the following:

1. Press ***10***.
2. Enter the *search profile digit* (1-5).
3. Press **#** and .

Wait for the call timer to start in the display.

4. Press  to finish the procedure.

Note: When another party, such as a colleague or operator, is included in the activated profile, remember to inform them about your absence. If voice mail is included in the activated profile, make sure that your greeting is updated with the correct absence information.

13.4.2

Cancelling Personal Number From Your Office Phone

To cancel the personal number feature from your phone, do the following:

1. Press **#10#**.
2. Press .

Wait for the call timer to start in the display.
3. Press  to finish the procedure.

13.4.3

Activating or Changing Personal Number From an External Phone

To be able to activate the personal number feature from an external phone, the external phone must be of push button type and provided with the keys **#** and *****, or a mobile phone adapted for dial tone pulses (DTMF).

To activate the personal number feature, or change to another profile from an external phone, do the following:

1. Call the DISA function at your office.

Wait for a dial tone.
2. Press ***75***.

Note: Germany, The Netherlands, and Sweden, press ***72***.
3. Enter the *authorization code* and press *****.
4. Dial your own *extension number* and press **#**.

Wait for a dial tone.
5. Press ***10***.
6. Dial your own *extension number* and press *****.
7. Enter the *search profile number*, (1-5).
8. Press **#** and .

Note: When another party, such as a colleague or operator, is included in the activated profile, remember to inform them about your absence. If voice mail is included in the activated profile, make sure that your greeting is updated with the correct absence information.

13.4.4 Cancelling From External Phone

To be able to cancel the personal number feature from an external phone, the external phone must be of push button type, provided with the keys # and *, or a mobile phone adapted for dial tone pulses (DTMF).

To cancel the personal number feature from an external phone, do the following:

1. Call the DISA function at your office.

Wait for a dial tone.

2. Press ***75***.

Note: Germany, The Netherlands, and Sweden, press ***72***.

3. Enter the *authorization code* and press *****.
4. Dial your own *extension number* and press **#**.
5. Press **#10***.
6. Dial your own *extension number* and press **#**.
7. Press .

13.4.5 Creating and Using Search Profiles

To set up your profiles, you copy the settings forms below (table 7 on page 79, table 8 on page 79, table 9 on page 79, table 10 on page 80, and table 11 on page 80), fill in your new or changed profiles and hand it to the system administrator. The search profiles are installed or changed by the system administrator.

Note: If a profile handling application is connected to the system, profiles can be edited via the Intranet. See separate instructions for the profile handling application.

When you create a search profile, keep the following in mind:

- Avoid ring times longer than 45 seconds for your profiles. Usually the caller hangs up after 3–6 ring signals. If you need a longer ring time, the maximum time is 60 sec.
- Consider the time you need to react and answer on each answering position in your profile. You might need up to 15 seconds to react and answer a call on a desk or cordless phone and 20–25 seconds for a mobile phone.
- There must be an answering position at the end of every profile (Voice Mail or operator/secretary). If not, calls might end up unanswered.

- Consider what should happen while you are busy on a phone. Available options are *Diversion to Voice Mail* and *Diversion to the operator*.
- If an answering machine, a fax or other answering device is used as an early answering position, it might interrupt the searching. Disconnect the answering device, or design the ring times so they do not affect the searching.
- If your system admits only one single personal profile, design the profile with your 2–3 most frequently used positions only. If you add more numbers, there is a risk that the caller hangs up before the call gets answered.
- If your system admits 1–5 personal profiles, design the different profiles to fit your most frequently used positions. Make sure you use as few answering positions as possible for each profile. Profile examples are *In office*, *At home*, *Traveling*, and *Absent/not reachable*.

How to fill in the settings forms for search profiles are described in table 5 on page 78 and table 6 on page 78.

Table 5 Profile 1 - In office

Search order	Type of phone or Answering position	Phone number	Ring time (seconds)
1	Desk	1234	10
2	Cordless	5234	15
3	Voice Mail		

Table 6 Profile 2 - At home

Search order	Type of phone or Answering position	Phone number	Ring time (seconds)
1	External	222222	20
2	Mobile	0706666666	25
3	Voice Mail		

13.5 Settings Form For Search Profiles

Fill in your contact details

- Name: _____
- Department: _____
- Phone Number: _____
- Account: _____

Table 7 Profile 1 - _____

Search order	Type of phone or Answering position <small>Can be Desk, Cordless, Mobile, External, Voice Mail, Operator, and so on.</small>	Phone number	Ring time (seconds)
1			
2			
3			

Table 8 Profile 2- _____

Search order	Type of phone or Answering position <small>Can be Desk, Cordless, Mobile, External, Voice Mail, Operator, and so on.</small>	Phone number	Ring time (seconds)
1			
2			
3			

Table 9 Profile 3- _____

Search order	Type of phone or Answering position <small>Can be Desk, Cordless, Mobile, External, Voice Mail, Operator, and so on.</small>	Phone number	Ring time (seconds)
1			
2			

Search order	Type of phone or Answering position Can be Desk, Cordless, Mobile, External, Voice Mail, Operator, and so on.	Phone number	Ring time (seconds)
3			

Table 10 Profile 4 - _____

Search order	Type of phone or Answering position Can be Desk, Cordless, Mobile, External, Voice Mail, Operator, and so on.	Phone number	Ring time (seconds)
1			
2			
3			

Table 11 Profile 5 - _____

Search order	Type of phone or Answering position Can be Desk, Cordless, Mobile, External, Voice Mail, Operator, and so on.	Phone number	Ring time (seconds)
1			
2			
3			



13.6 Remote Programming of Diversion

13.6.1 Remote Programming of Direct Diversion



By using Direct diversion, incoming calls are directly forwarded to a predefined extension. Using remote programming of Direct diversion, you can manage the Direct diversion settings of other extensions besides the extension you are currently located at. You can, for

example, activate Direct diversion for extension 1234 while being located at extension 5678.

Follow the steps below to activate Direct diversion for another extension:

1. Press ***21*** *extension number to divert* * #
2. Press  and wait for the call timer to start in the display.
3. Press .

Follow the steps below to terminate Direct diversion for another extension:



1. Press **#21*** *diverted extension number* #
2. Press  and wait for the call timer to start in the display.
3. Press .

13.6.2



Remote Programming of Diversion on No Answer

By using Diversion on no answer, incoming calls are forwarded to a predefined extension after a number of signals. Using remote programming of Diversion on no answer, you can manage the Diversion on no answer settings of other extensions besides the extension you are currently located at. You can, for example, activate Diversion on no answer for extension 1234 while being located at extension 5678.

Follow the steps below to activate Diversion on no answer for another extension:

1. Press ***211*** *extension number to divert* #
2. Press  and wait for the call timer to start in the display.
3. Press .

Follow the steps below to terminate Direct diversion for another extension:

1. Press **#211*** *diverted extension number* #
2. Press  and wait for the call timer to start in the display.
3. Press .



13.6.3

Remote Programming of Diversion on Busy



By using Diversion on busy, incoming calls are forwarded to a predefined extension when you are busy in a call. Using remote programming of Diversion on busy, you can manage the Diversion on busy settings of other extensions besides the extension you are

currently located at. You can, for example, activate Diversion on busy for extension 1234 while being located at extension 5678.

Follow the steps below to activate Diversion on busy for another extension:

1. Press ***212*** *extension number to divert #*
2. Press  and wait for the call timer to start in the display.
3. Press .

Follow the steps below to terminate Direct diversion for another extension:

1. Press **#212*** *diverted extension number #*
2. Press  and wait for the call timer to start in the display.
3. Press .

14 Absence Information (Optional)

Absence information is used to inform callers why you are absent and when you will return. If your own extension is the answering position for another extension, you can enter absence information for that extension, if you are authorized to do so.

When the absence information feature is enabled, a special dial tone will be heard. The phone can still be used for outgoing calls.

Note: This feature needs to be configured in the WinPDM or CPDM by the system administrator.

14.1 Ordering Absence Information For Your Extension

To order absence information, do the following:

1. Press **Menu**, select , and press **Select**.
2. Select **Call services**, and press **Select**.
3. Select **Absence** and press **Select**.

The available absence reasons are displayed. The options may vary depending on the configuration in the PDM. For more information, contact the system administrator.

4. Select an absence reason, and press **Select**.
5. Depending on the selected option, enter date (MMDD) or time (HHMM), and press **OK**.

The phone calls the system and sends an absence code. The call is disconnected automatically after a few seconds.



6. When the call timer starts in the display, press  to finish the procedure.

The display now shows the selected reason, and the time or date of return.

OR

1. Press ***23***.

Note: U.S. and Canada, press ***24***

2. Enter the *absence code* (0-9) and, if requested, enter time or date of return preceded by *.
3. Press # followed by  and .

Note: The absence codes are system dependent. Contact the system administrator regarding the available absence codes.

14.2 Cancelling Absence Information For Your Extension

To cancel absence information, do the following:

1. Press **Menu**, select , and press **Select**.
2. Select **Call services**, and press **Select**.
3. Select **Absence** and press **Select**.
4. Select **Deactivate** and press **Select**.

The phone calls up the system. Wait for the call timer to start in the display.

5. Press  to finish the procedure.

The absence information is deleted.

OR

1. Press **#23#**.

Note: U.S. and Canada, press **#24#**

2. Press  and .

14.3 Ordering Absence Information For Another Extension

It is only possible to order absence information for another extension if you are authorized to do so, and if your own extension is the answering position of the other extension.

To order absence information for another extension, do the following:

1. Press ***230***.
2. Dial the *extension number* and press *.
3. Enter the *absence code* (0-9).

4. Press * and enter the date or time for when the other person will return.

5. Press # and .

Wait for the call timer to start in the display.

6. Press  to finish the procedure.

The display on the other person's extension shows the reason, and if entered, time or date of return.

14.4

Cancelling Absence Information For Another Extension

To cancel absence information for another extension, do the following:

1. Press #230*.

2. Dial the *extension number* and press # and .

Wait for the call timer to start in the display.

Note: If the special dial tone is received, the *authorization code* for the other extension is required. Enter the code and press #.

3. Press  to finish the procedure.

15 Messages

There are three types of messages available in the DT690 phone:

- Text Messages (SMS), see Text Messages (SMS) on page 86.
- Manual Message Waiting (MMW), see Manual Message Waiting (MMW) on page 90.
- Voice Mail, see Voice Mail (Optional) on page 91.

Note: If you receive a message during an ongoing call, you are notified by a beep. The new message icon that appears will remain in the display until all new messages are opened.

15.1 Text Messages (SMS)

It is possible to send and receive text messages, that is SMS (Short Message Service), to and from other phones in your system. The thirty last received messages are stored in the message list. The message list is located in the Messaging menu. Time and date information is included in the message.

Note: Text messages can be sent and received only if the Aastra Integrated Messaging Server is installed and configured in the WinPDM or CPDM. For more information, contact the system administrator.

15.1.1 Receiving a Message

A received but unread message is indicated by the new text message icon, , which appears in the display along with the following message: New message. View now?.

The icon remains in the display until all new messages are opened. If the message is received during a call, you are notified by a beep.

To open a received message, do the following:

1. Press **Yes** to open the mail inbox (or press **No** if you want to open the message later. The message will be stored in the inbox in both cases.) The text message appears in the display.
2. When you have read the message, several options are available.
You can reply to, delete, or forward a received message immediately, or call the sender or the message, or call or save a number included in the message.

Note: You can choose to perform these actions later by opening the Inbox from the **Messaging** menu. See the following sections for detailed instructions.

Instead of opening a text message immediately when it is received, you can view it later.

To view a text message later, do the following:

1. Press **Menu**, select , and press **Select**.
2. Select **Inbox**, and press **Select**.
3. Select which message to view and press **View**.

The message opens.

4. Press **Close** to close the message.

15.1.1.1

Replying to a Message

To reply to a message, do the following:

1. Press **Menu**, select , and press **Select**.
2. Select **Inbox**, and press **Select**.
3. Select which message to reply to and press **View**.
4. Select **Reply**.
5. Write the message and press **Send**.

Note: For instructions on how to write text and numbers, see Writing Text and Numbers on page 57.

15.1.1.2

Deleting a Message

To delete a message, do the following:

1. Press **Menu**, select , and press **Select**.
2. Select **Inbox**, and press **Select**.
3. Select which message to delete and press **More**.
4. Select **Delete** or **Delete all**, and press **Select**.

A confirmation message appears.

5. Press **Yes** to confirm.

The message is deleted.

15.1.1.3 Calling the Sender of a Message

To call the sender of a message, do the following:

1. Press **Menu**, select , and press **Select**.
2. Select **Inbox**, and press **Select**.
3. Select which message to view, and press **View**.
4. Select **More**, then **Call sender**, and press **Select**.

15.1.1.4 Calling a Phone Number Included In a Message

If the sender has written a phone number in the message, it is possible to call this number without dialing it.

To call a number included in a message, do the following:

1. Press **Menu** select , and press **Select**.
2. Select **Inbox**, and press **Select**.
3. Select a message, and press **View**.
4. Select **More**, then **Call no. in text**, and press **Select**.

Note: This option is available only if the number contains minimum 3 digits.

5. Press **Call**.

15.1.1.5 Saving a Number Included In a Message

To save a number from a message, do the following:

1. Press **Menu**, select , and press **Select**.
2. Select **Inbox**, and press **Select**.
3. Select a message, and press **View**.
4. Select **More**, then **Save number**, and press **Select**.
5. Select **Work number**, **Mobile number** or **Other number**, and press **Select**.
6. Select **Name**, and press **Add**.
7. Enter a name and press **OK**.
8. Press **Back**.

The number will be saved in the contact list.

15.1.2 Writing and Sending a Message

To write and send a message, do the following:

1. Press **Menu**, select , and press **Select**.
2. Select **Write new message**, and press **Select**.
3. Write the message and press **Send**.

Note: The maximum message length is 160 characters (Keys 0-9, * or # can be used. Keys 0 and 1 contains special characters.) See figure 14 on page 58 to see all characters. Some characters require 2 bytes in the final message, which means that the total number of characters can be less than 160.

4. Dial a number, or press the middle soft key, to enter the contact list.
5. Press **Send** to send the message.

The first character entered will be an upper level character followed by lower level characters unless the  is pressed before entering the character.

When you press a key, the first available character on that specific key is displayed. To get any of the other characters on that key, press the key until that character appears in the display. For example, to enter the character E, press twice on the key 3. E appears in the display and is selected after a time out or when another key is pressed.

Note: To delete a character, press **Clear**.

15.1.2.1 Opening a Sent Message

To open a sent message, do the following:

1. Press **Menu**, select , and press **Select**.
2. Select **Sent**, and press **Select**.
3. Select a message, and press **View**.

15.1.3 Forwarding a Message

You can forward both received and sent messages to other destinations.

To forward a message to another phone number, do the following:

1. Press **Menu**, select , and press **Select**.
2. Select **Inbox** to forward a *received* message and press **Select**.

Or

- Select **Sent** to forward a *sent* message and press **Select**.
3. Select a message, and press **View**.
 4. Press **More** and select **Forward**, and press **Select**.
 5. Edit the message (optional), and press **Send**.
 6. Dial the number, or press the soft key  to select a number from the contact list, and press **Send** to forward the message.

15.2 Manual Message Waiting (MMW)

The Manual Message Waiting (MMW) feature enables you to send and receive message waiting signals when the line is busy

- MMW allows you to send a message waiting signal to an extension that does not answer when you call (if this feature is allowed, this is set by the system administrator).
- MMW allows you to receive a message waiting signal from someone who has tried to contact you.

15.2.1 Answering a Manual Message Waiting

If there is a message waiting for you, you will hear a special dial tone, and the following message is displayed: `New voice mail message(s). View now?`

To answer a message waiting, do the following:

1. Press **Yes** to open the mailbox (or **No** to check the message later).

The icon  is displayed along with the following message: `You have a new voice mail message. Call to listen to the message.`

2. Press **Call**.

A call is initiated to the extension that requested the MMW.

15.2.2 Ordering an MMW Indication

To order a MMW indication to another extension, do the following:

1. Press ***31***.
2. Dial the *extension number* and press **#** and .

Wait for the call timer to start in the display.

3. Press  to finish the procedure.

The message is sent to the called extension.

15.2.3

Canceling an MMW Indication

To cancel a MMW indication that you have sent to another extension, do the following:

1. Press **#31***.

Note: U.S. and Canada, press **#56***.

2. Dial the *extension number* and press **#** and .

Wait for the call timer to start in the display.

3. Press  to finish the procedure.

15.3

Voice Mail (Optional)

The voice mail application allows you to send and receive recorded voice messages. You can choose to have all incoming calls diverted to your mailbox directly, or at to answer, when busy tone, or both.

Note: If you are using the personal number feature, you are recommended to program voice mail as the last answering position for all search profiles.

When an incoming call is diverted to the voice mail, a recorded message will be played.

A caller who has been diverted to your mailbox may leave a voice message of their own which you later can retrieve from your mailbox.

When you enter your mailbox, you will hear recorded instructions on how you do to listen to, record, store and delete messages, and how to change your security code.

Note: How to handle your mailbox depends on the type of voice mail application used. For more information, contact the system administrator, and see separate instructions for the voice mail application used.

15.3.1

Activating Voice Mail

For instructions on how to activate voice mail, see Diversion from Call Services Menu on page 71. Use the number to the voice mail system as the diversion number.

15.3.2 Listening To Voice Mail

When you receive a new voice mail, the voice mail icon  appears in the status bar, where it remains until you have deleted the message. A notification is also displayed in a dialog window.

Note: This function is configured in the WinPDM or CPDM. Please contact the system administrator.

15.3.2.1 Listening To New Voice Mail Directly

When a new message is received, the following message appears: *New voice mail message(s). View now?*

To listen to a voice mail message directly, do the following:



1. Press **Yes** to open the mail inbox (or press **No** to open the message later).

The icon  and the following message is displayed:

You have a new voice mail message. Call to listen to the message.

2. Press **Call**.

The message is played.

Note: The icons  in the status bar, and  in the inbox disappear when you have listened to the message.

15.3.2.2 Listen to New Voice Mail Later

Instead of listening to a voice mail message immediately when it is received, you can listen to it later. You do this in one of the following ways:

1. Press and hold 1, when in idle mode.

If the following message is displayed, the voice mail number needs to be configured to the voice mail button: *Voice mail number not defined.* Contact the system administrator.

2. Listen to the voice mail and follow the recorded instructions.

OR

1. Press **Menu**, select , and press **Select**.
2. Select **Inbox**, and press **Select**.

If you are prompted for your security code, enter it.

Note: The security code is the same as the extension number at delivery.

The icon  is displayed first in the inbox list.

3. Select the voice mail message, and press **View**.
4. Press **Call**.

Note: Only one voice mail at the time will be displayed, even if the message list contains several voice mail messages.

16 Group Features

This chapter describes the different group features available for this cordless phone.

16.1 Group Call Pickup

People working in a team can have their phones programmed by their system administrator to form *call pickup groups*. In a call-pick-up group, any member can answer any individual call to group members.

To enable this function, do the following

1. Press ***8#**.

Note: Finland and Sweden, press ***0#**;
U.S. and Canada, press ***59#**.

2. Press  to answer.

One call-pick-up group can serve as an alternative to another group. Calls to the alternative group can only be answered when there are no calls to your own group.

16.2 Common Bell Group

Calls are signalled on a common bell. To answer, do the following:

1. Press ***8#**.

Note: Finland and Sweden, press ***0#**;
U.S. and Canada, press ***59#**.

2. Press  to answer.

16.3 Group Hunting



An internal group hunting number is a common directory number for a group of extensions. Calls to the group will be indicated at a free extension in the group. When you leave the group temporarily, you make your phone unavailable for incoming calls.

16.3.1 Answering a Group Call

A group call is answered in the normal way.



16.3.2 Leaving the Group Temporarily

To leave a group temporarily, do the following:

1. Press ***21***.
Note: U.K., press ***2***.
2. Dial your own *extension number* and press **#** and .
Wait for the call timer to start in the display.
3. Press  to finish the procedure.

16.3.3 Reentering the Group

To reenter the group, do the following:

1. Press **#21#**.
Note: U.K., press **#2#**.
2. Press .
Wait for the call timer to start in the display.
3. Press  to finish the procedure.

17 Other Useful Features

This chapter describes more useful features available for the cordless phone and the exchange.

17.1 Account Code

The account code function is used to charge a call to an account number or to prevent unauthorized calls from your phone. The account code can have 1 to 15 digits.

To enable this function, do the following:

1. Press ***61***.

Note: Finland and Norway, press ***71***.

2. Dial the *account code* and press **#** and .

Wait for a dial tone.

3. Dial the digit or digits to get an external line and the external number.

17.1.1 Ongoing External Call

When the account code function is used to charge a call, it is also possible to connect an ongoing external call to an account code.

During the call, do the following:

1. Press **R** to put the ongoing call on hold.

Wait for a dial tone.

Note: The soft key **R** is default. If this soft key is reprogrammed to something else, this function will not be available.

2. Press ***61***.

Note: Finland and Norway, press ***71***.

3. Enter the *account code* and press **#**.

Wait for a dial tone.

4. Press **R**.

5. Press  to resume the call that was put on hold.

17.2 Call Statistics

Your phone can tell you the duration of your last call and display the total time of all calls.

To see the time spent on your last call and on all outgoing calls, do the following:

1. Press **Menu**, select , and press **Select**.
2. Select **Call time** and press **Select**.

The display shows duration information in hours and minutes for the **Total time** as well as for the **Last call**.

17.3 General Deactivation

The general deactivation feature allows you to cancel the following features simultaneously:

- Callback (all callbacks are cancelled).
- Internal and External Follow-me
- Manual Message Waiting/Message Diversion

17.3.1 Ordering General Deactivation

To order general deactivation, do the following:

1. Press **#001#**.

Note: U.S. and Canada, press **#0#**.

2. Press .

Wait for the call timer to start in the display.

3. Press  to finish the procedure.

17.4 Night Service

When the exchange is in *night service mode*, all incoming calls to the operator are transferred to a specified extension or group of extensions. Night service mode is used outside business hours.

Common Night Service

All incoming calls to the operator are transferred to one specific extension. Answer the call in the normal way.

Individual Night Service

Selected external calls to the operator are transferred to one specific extension. Answer the call in the normal way.

Universal Night Service

All incoming calls to the operator are transferred to a universal signaling device, for example the common bell. Answer the call as described in Common Bell Group on page 94.

17.5 Emergency Mode

In the event of an emergency, the operator can set the exchange into *emergency mode*, during which only pre-programmed extensions are permitted to make calls. If your extension is not assigned with this category and you try to make a call, you will not receive a dial tone.

17.6 Malicious Call Tracing

If you are being disturbed by bothersome or malicious external incoming calls, it is possible to request number tracing from the network provider. Tracing can be invoked during or after an ongoing conversation. The external line can be held for a limited period of time.

17.6.1 Ordering Call Tracing

To order call tracing during an ongoing conversation, do the following:

1. Press **R**.
Wait for a dial tone.
2. Press ***39#**.

The system acknowledges with different tones whether the tracing request was accepted or rejected.

17.7 Direct Inward System Access (DISA)

If you are assigned to use the DISA function, you can work from outside the office network and still have all your outgoing business calls charged to your office extension number or an account number.

You will only be charged for the call you have to make to the office in order to get access to an external line through the office network.

Note: The external phone must be of push button type provided with the keys # and *, or a mobile phone adapted for dial tone pulses (DTMF).

You have to initiate DISA for every individual business call you make. This means that you have to terminate a DISA call before you can make a new DISA call. The procedure varies depending on which authorization and account codes you use, see below.

17.7.1 Calling With an Common Authorization Code

To make a DISA call using a common authorization code, do the following:

1. Call the DISA function at your office.
Wait for a dial tone.
2. Press ***72***.
3. Dial the *authorization code* and press **#**.
Wait for a dial tone.
4. Dial the *external number*.

17.7.2 Calling With an Individual Authorization Code

To make a DISA call using an individual authorization code, do the following:

1. Call the DISA function at your office.
Wait for a dial tone.
2. Press ***75***.
3. Dial the *authorization code* and press *****.
4. Dial your *own extension number* and press **#**.
Wait for a dial tone.
5. Dial the *external number*.

18 Settings



From the **Settings** tab, , in the main menu, it is possible to change for example sound and alert settings, display settings, and time and date settings.

18.1 Sound and Alerts

Sound and alert settings include ringer volume, ring signals and so on.

18.1.1 Adjusting Ringer Volume

To adjust ringer volume, do the following:

1. Press **Menu**, select , and press **Select**.
2. Select **Sound & Alerts**, and press **Select**.
3. Select **Volume**, and press **Select**.
4. Step with  to increase the volume and  to decrease it.
5. Press **OK** to save the settings.

18.1.2 Different Ring Signals for Different Call Types

You can have different ring signals for internal and external calls and callback calls.

To set different ring signals for different call types, do the following:

1. Press **Menu**, select , and press **Select**.
2. Select **Sound & Alerts**, and press **Select**.
3. Select **Ring Signals**, and press **Select**.
4. Select **Internal call**, **External call** or **Callback**, and press **Select**.
5. Select a ring signal, press **Select**, and press **Back** to save the setting.

18.1.3 Switching Vibrator On and Off

To switch the vibrator on and off, do the following:

1. Press **Menu**, select , and press **Select**.

2. Select **Sound & Alerts**, and press **Select**.
3. Select **Vibrating alert**, and press **Select**.
4. Choose between **On**, **On when silent** (the vibrator is on when the phone is muted), or **Off**, and press **Select**.
5. Press **Back** to save the setting.

18.1.4 Message Alert

It is possible to set different message alerts. Do the following:

1. Press **Menu**, select , and press **Select**.
2. Select **Sounds & Alerts**, and press **Select**.
3. Select **Message alert**, and press **Select**.
4. Choose between the 8 different message alerts.

It is possible to listen to the message alerts by pressing **Play**.

5. Press **Back** to save the settings.

18.1.5 Setting the Key Sound

Setting the key sound means that each time a key is used, the phone gives a small sound. To enable this function, do the following:

1. Press **Menu**, select , and press **Select**.
2. Select **Sounds & Alerts**, and press **Select**.
3. Select **Key sound**, and press **Select**.
4. Choose between **Click**, **Tone** or **Silent**.

It is possible to listen to the key sound by pressing **Play**.

5. Press **Select**.
6. Press **Back** to save the setting.

18.2 Display

Display settings include brightness and screen saver settings.

18.2.1 Brightness

To set the brightness, do the following:

1. Press **Menu**, select , and press **Select**.
2. Select **Display** and press **Select**.
3. Select **Brightness**, and press **Select**.
4. Select **Normal** or **Power save**, and press **Select**.
5. Press **Back** to save the setting.

18.2.2 Screen Saver

To set the screen saver, do the following:

1. Press **Menu**, select , and press **Select**.
2. Select **Display**, and press **Select**.
3. Select **Screen saver**, and press **Select**.
4. Select **Information** or **Black**, and press **Select**.
5. Press **Back** to save the setting.

18.2.3 Contrast

To adjust the contrast, do the following:

1. Press **Menu**, select , and press **Select**.
2. Select **Display**, and press **Select**.
3. Select **Contrast**, and press **Select**.
4. Press the left or right navigation key to increase or decrease the contrast.
5. Press **OK** to save the setting.

18.3 Time and Date

You can set time and date by following the instructions in the following two sections.

18.3.1 Setting Time Format

To set the time, do the following:

1. Press **Menu**, select , and press **Select**.

2. Select **Time & Date**, and press **Select**.
3. Select **Time format**, and press **Select**.

The actual time is displayed. The formats to select from are the following:

- 12:00 (AM/PM)
 - 24:00
4. Press **Back** to save the settings.

18.3.2

Setting Date Format

To set the date, do the following:

1. Press **Menu**, select , and press **Select**.
2. Select **Time & Date**, and press **Select**.
3. Select **Date format**, and press **Select**.

The formats to select from are the following:

- DD/MM/YYYY (that is, 17/09/2009, also called Europe)
 - MM/DD/YYYY (that is, 09/17/2009, also called US)
 - YYYY-MM-DD (that is, 2009-09-17, ISO 8601)
 - MMM DD YYYY (that is, Sept 17 2009)
 - DD MMM YY (that is, 17 Sept 09)
 - DD.MM.YYYY (that is, 17.09.2009)
 - DD-MM-YYYY (that is, 17-09-2009)
4. Press **Back** to save the setting.

18.4

Phone Locks

There are two different phone locks:

- **Key lock**, which prevents keys to be pressed by mistake.
- **Phone lock**, which protects the phone from unauthorized use.

When the phone lock function is activated, you are prompted for a PIN code when you turn on the phone.

18.4.1 Activating Automatic Key Lock

The keypad can be set to lock 20 seconds after it was last used. When in idle mode a locked keypad is indicated by .

To activate the automatic key lock, do the following:

1. Press **Menu**, select , and press **Select**.
2. Select **Locks** and press **Select**.
3. Select **Automatic key lock** and press **Select**.
4. Select **On**, and press **Select**.
5. Press **Back** to save the setting.

Note: It is possible to answer or reject incoming calls while the keypad is locked. If configured in the WinPDM or CPDM, it is also possible to make an emergency call while the keypad is locked.

18.4.2 Activating Manual Key Lock

You are recommended always to have the automatic lock on, but it is possible to manually lock and unlock the keypad as well.

To lock the keypad manually, do the following:

1. Press  .
2. Press **Lock**.

The icon  indicates that the keypad is locked.

Note: It is possible to answer or reject incoming calls while the keypad is locked. If configured in the WinPDM or CPDM, it is also possible to make an emergency call while the keypad is locked.

18.4.2.1 Unlocking the Key Lock Manually

To unlock the keypad, do the following:

1. Press  .
2. Press **Yes**.

18.4.3 Activating Phone Lock

Activating Phone lock will protect the phone from unauthorized use. When this function is activated, the PIN code has to be entered at power on. When activating Phone lock the PIN code that must be entered. The

PIN code is by default (0000) but it can be changed to any 4-8 digit code, see Changing PIN Code on page 105.

To activate the phone lock, do the following:

1. Press **Menu**, select , and press **Select**.
2. Select **Locks** and press **Select**.
3. Select **Phone lock** and press **Select**.
4. Select **Auto phone lock** and press **Select**.
5. Select **On**, or **On in charger**, and press **Select**.
6. Enter the PIN code, and press **OK**.
7. Press **Back** to save the settings.

When the phone is locked,  is shown in the display.

Note: If configured in the WinPDM or CPDM, it is possible to make an emergency call while the phone or keypad is locked. During an ongoing emergency call, the soft keys **More** and **R** are disabled.

If PIN code is lost it is possible to configure a new, or to do a factory reset in WinPDM or CPDM, contact the system administrator.

18.4.4 Deactivating Phone Lock

To deactivate the **Phone lock** function, do the following:

1. Press **Menu**, select , and press **Select**.
2. Select **Locks** and press **Select**.
3. Select **Phone lock** and press **Select**.
4. Select **Auto phone lock** and press **Select**.
5. Select **Off**, and press **Select**.
6. Enter the *PIN code*, press **OK**.
7. Press **Back** to save the setting.

18.4.5 Changing PIN Code

To change PIN code, do the following:

1. Press **Menu**, select , and press **Select**.
2. Select **Locks** and press **Select**.

3. Select **Phone lock** and press **Select**.
4. Select **Change PIN code** and press **Select**.
5. Enter the *old PIN code* (default is 0000) and press **OK**.
6. Enter the *new PIN code*.
7. Enter the *new PIN code* again to confirm and press **Save**.

The following message is displayed: `New PIN code saved.`

18.5 Changing the Owner ID

The Owner ID is set to identify the phone. To change the owner ID, do the following:

1. Press **Menu**, select , and press **Select**.
2. Select **Owner ID**, and press **Select**.
3. Enter a name and press **Save** to save the setting.

18.6 Changing Answering Methods

The phone can be set to answer a call automatically when a headset is used, or to answer a call by a press on any key.

You can also change the answering behavior to:

- use **Loudspeaking** directly when  is pressed.
- automatically connect incoming call in **Loudspeaking** mode, without pressing any key.

18.6.1 Normal Answering

The answering behavior is set to **Hook-off** by default. You can set it to any key by doing the following:

1. Press **Menu**, select , and press **Select**.
2. Select **Answering**, and press **Select**.
3. Select **Answering key**, and press **Select**.
4. Select **Any key** and press **Select**.
5. Press **Back** to save the setting.

18.6.2 Automatic Answer (Headset Mode)

Note: The automatic answer mode is only relevant when a headset or a Bluetooth headset is connected.

To set the phone to answer automatically, do the following:

1. Press **Menu**, select , and press **Select**.
2. Select **Answering**, and press **Select**.
3. Select **Answer behaviour**, and press **Select**.
4. Select **Automatically** and press **Change** to activate the automatic mode.
5. Press **Back** to save the setting.

All incoming calls will be connected automatically when this behavior is selected.

To remove the setting, press **Change**.

18.6.3 Loudspeaking (Handsfree Mode)

To set the phone to automatically answer with loudspeaker when you press , do the following:

1. Press **Menu**, select , and press **Select**.
2. Select **Answering**, and press **Select**.
3. Select **Answer behaviour**, and press **Select**.
4. Select **Loudspeaking** and press **Change** to activate.
5. Press **Back** to save the setting.

18.7 Changing Menu Language

Display messages are available in 18 languages: Brazilian Portuguese, Czech, Danish, Dutch, English, Finnish, French, German, Greek, Hungarian, Italian, Norwegian, Polish, Russian, Slovak, Spanish, Swedish and Turkish.

Note: It is possible to download one additional language to the phone. Languages available for download are: Czech, Greek, Hungarian, Polish, Portuguese, Russian, Slovak or Turkish. Contact the system administrator for more information.

To switch menu language, do the following:

1. Press **Menu**, select , and press **Select**.
2. Select * **Language**, and press **Select**.
3. Select one of the languages from the list, and press **Select**.

Note: The * in * **Language** is there for you to easily find where to switch languages if the current language used is not one that you know.

18.8

Changing Text Size for Messages

Note: This is only for text size in messages, not for text in menus or soft keys.

To change text size, do the following:

1. Press **Menu**, select , and press **Select**.
2. Select **Messages**, and press **Select**.
3. Select **Text size**, and press **Select**.
4. Select between **Normal** and **Large**, and press **Select**.
5. Press **Back** to save the setting.

19 Connections

In the **Connections** tab,  , the following options are available: **Bluetooth**, **System**, **In charger**, and **Headset**.

Note: Bluetooth is optional, and is only visible in the connections menu if Bluetooth is ordered with the phone.

19.1 Bluetooth

19.1.1 Enabling Bluetooth

To enable Bluetooth connection, do the following:

1. Press **Menu**, select  , and press **Select**.
2. Select **Bluetooth**, and press **Select**.
3. Select **Enable**, and press **Select**.

The Bluetooth icon,  , is displayed in the idle screen.

19.1.2 Disabling Bluetooth

To disable Bluetooth connection, do the following:

1. Press **Menu**, select  , and press **Select**.
2. Select **Bluetooth**, and press **Select**.
3. Select **Disable**, and press **Select**.

19.1.3 Connecting a Bluetooth Headset

To connect Bluetooth Headset, do the following:

Note: Only if Bluetooth connection is enabled.

1. Press **Menu**, select  , and press **Select**.
2. Select **Bluetooth**, and press **Select**.
3. Select **Headset** and press **Select**.
4. Select **Add new**, and press **Select**.

The following text is displayed: Put headset in Pairing mode.

5. Press **OK**.

The phone searches for a Bluetooth headset to connect to.

6. If a headset is found, press **Pair**.
7. Enter the *PIN code*.

See the user manual for the Bluetooth headset.

8. Press **OK**.

If the pairing mode was successful, the following message is displayed: *Pairing successful*.

When a Bluetooth headset is connected,  is displayed.

19.2 System

The cordless phone supports GAP/CAP standard. This makes it possible to log on to any GAP compatible system with your phone. Only available systems are displayed.

19.2.1 Selecting a System

To select a system, do the following:

1. Press **Menu**, select , and press **Select**.
2. Select **System**, and press **Select**.
3. Select **Change system** and press **Select**.
4. Select **Automatically** (or a specific system from the list), and press **Select**.

If the phone is set to **Automatically**, a system will be selected according to the priority list.

19.2.1.1 Setting System Priority

The default order of priority is the order of entered subscriptions. This means that the first subscribed system has the highest priority. This list can be edited by the user. It is possible to set the systems in priority by moving them up or down in the list. It is also possible to get priority information by selecting **Info**.

1. Press **Menu**, select , and press **Select**.
2. Select **System**, and press **Select**.
3. Select **Priority**, and press **Select**.
4. Change the priority if needed by selecting **Up** or **Down**.
5. Press **Back** to save.

19.2.2 Subscribing To a New System

The cordless phone can subscribe to up to 8 different cordless systems. To subscribe a new system, you will need the Portable Access Right Key (PARK) and Authentication code (AC) related to the system you are going to logon to. To retrieve this information, contact the system administrator.

To subscribe to a new system, do the following:

1. Press **Menu**, select , and press **Select**.
2. Select **Systems**, and press **Select**.
3. Select **Subscribe**, and press **Select**.
4. Enter the system name and press **Next**.
5. Enter the PARK code.
6. Enter the AC code (minimum 4 digits) and press **Next**.

The following message is displayed: `Protection on?`

7. Select **Yes**, if the new system is to be protected, or **No** if the new system is not to be protected.

Note: It is not possible to delete a protected subscription.

8. Press **OK**.

A searching mode starts.

19.2.3 Unsubscribing From a System

To unsubscribe from a system, do the following:

1. Press **Menu**, select , and press **Select**.
2. Navigate to **System**, and press **Select**.
3. Select **Unsubscribe**, and press **Select**.

Note: It is not possible to unsubscribe a protected system via the System menu. For more information, contact the system administrator.

4. Select system to unsubscribe, and press **Select**.

A control question whether to unsubscribe or not is asked, press **Yes** to confirm.

Note: It is not possible to delete a protected subscription from the System menu. Contact the system administrator if you need to delete a protected subscription.

19.2.4 Renaming a System

It is possible to change the name of the system in the phone.

To rename a system, do the following:

1. Press **Menu**, select , and press **Select**.
2. Select **System**, and press **Select**.
3. Select **Rename System**, and press **Select**.
4. Select a system from the list, and press **Edit**.
5. Enter the new name.

If no name is entered, the phone will use the default name, "System A" or "System B", or other, depending on which system is free.

6. Press **Save** to save the changes.
7. Press **Back** to exit the menu.

19.3 In Charger

When your cordless phone is placed in a charger, incoming calls can be redirected to another extension. The phone can also be muted, or switched off while in the charger.

19.3.1 Redirecting Calls and Messages While Charging

To divert calls or messages when the phone is placed in the charger, do the following:

1. Press **Menu**, select , and press **Select**.
2. Select **In charger**, and press **Select**.

3. Select **Redirect**, and press **Select**.
4. Press **Back** to save the setting.

When an application or system sends a message to a redirected phone that is being charged, the application or system will receive an absence notification. If a phone is absent, the application or system determines whether the message should be sent to the phone, or whether it should be redirected to another phone.

Note: The redirection is cancelled automatically when the phone is removed from the charger.

19.3.2 Switching Off the Phone While Charging

To detach the phone while charging, do the following:

1. Press **Menu**, select , and press **Select**.
2. Select **In charger**, and press **Select**.
3. Select **Switch off**, and press **Select**.
4. Press **Back** to save the setting

Note: When the phone is removed from the charger it will switch back on again.

19.3.3 Muting the Phone While Charging

To mute the phone while charging, do the following:

1. Press **Menu**, select , press **Select**.
2. Select **In charger**, and press **Select**.
3. Select **Sound off**, and press **Select**.
4. Press **Back** to save the setting.

19.3.4 Deactivating the Charging Mode

To deactivate the charging mode, do the following:

1. Press **Menu**, select , press **Select**.
2. Select **In charger**, and press **Select**.
3. Select **No action**, and press **Select**.
4. Press **Back** to save the setting.

19.4 Headset Profiles

In order to achieve optimal audio quality with the different headset types, it is recommended that you select the corresponding profile. The default setting is microphone on a boom, meaning that the audio is optimized for using a headset with microphone on a boom.

To change the headset profile, do the following:

1. Press **Menu**, select , and press **Select**.
2. Select **Headset** and press **Select**
3. Select **Mic on boom**, **Mic on cable** or **Hearing protection**, and press **Select**.
4. Press **Back** to save the setting.

If the pre-configured headset profiles do not match the headset in use, or if the audio quality is low, it is possible to configure a new headset profile. This is done in WinPDM or CPDM by the system administrator.

20 Profiles

This chapter describes how to set up different profiles in the phone for incoming calls, message alerts, vibrating alerts, key sound, and so on. The possibility to set up different profiles in one phone is useful when several users have access to the same phone, or if you want to be able to have different settings for when you are available, in a meeting, out of office, and so on.

20.1 Adding a New Profile

To add a new profile to the phone, do the following:

1. Press **Menu**, select , and press **Select**.
2. Select **Add new** and press **Select**.
3. Enter the name of the profile and select **Save**.

20.2 Deleting a Profile

To delete a profile from the phone, do the following:

1. Press **Menu**, select , and press **Select**.
2. Select a profile from the list and press **More**.
3. Select **Delete** and press **Select**.
A confirmation message is displayed.
4. Press **Yes** to confirm.

20.3 Editing a Profile

To edit a profile in the phone, do the following:

1. Press **Menu**, select , and press **Select**.
2. Select a profile from the list and press **More**.
3. Select **Edit** and press **Select**.

A list of settings appears which you can edit.

4. Select which setting to edit, make the changes, and press **Back** to save the settings and return to the previous menu.

21 Installation

This chapter describes the battery and chargers and other equipment for the cordless phone.

21.1 Battery

Note: As an energy saving measure, disconnect the charger from the main socket after charging.

21.1.1 Charging the Battery

The battery needs charging when the low battery level symbol, , appears in the phone display.

Note: The battery can be charged separately with a special battery charger.

To charge the battery, place the phone in the desk charger, the desk PDM charger, or the rack PDM charger. For more information, see Chargers on page 120.

- A steady orange light indicates that the battery is being charged.
- A steady green light indicates a fully charged battery. (A flashing green indicator means incoming call or message.) In the phone display, an icon appears, showing a filled battery.
- A steady red light indicates a low battery level. In the phone display, an icon appears, showing an almost empty battery.
- An animated battery icon is shown in the display, indicating charging by starting with its current charge level and ending with the full charge.

Note: Only use the prescribed chargers for charging.

21.1.2 Charging Spare Batteries

Spare batteries can be charged with a separate battery pack rack charger. The battery pack rack charger can charge six batteries at the same time.

21.1.3 Replacing the Battery

If the standby time for the cordless phone becomes too low, replace the battery with a new one. Contact the system administrator or your certified Aastra Sales partner for information on new batteries.

The battery is easy to replace. It is attached inside the battery lid and is connected to the cordless phone in such a way as to avoid misinsertion. Attach the battery as described in figure 15 on page 118.

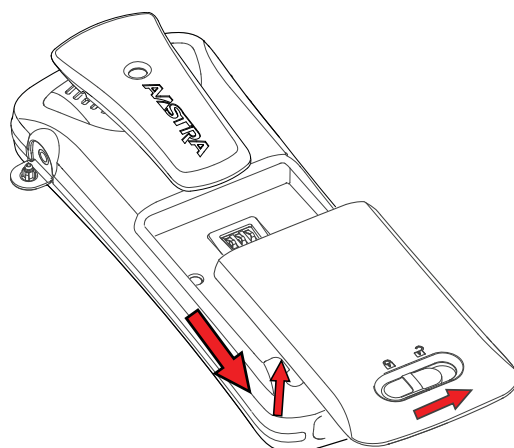

Figure 15: Unlock the lid and remove the battery

21.2 Accessories

21.2.1 Headset

If you frequently use the phone or want to have both hands free, it is recommended that you use a headset.

The headset for the DT690 cordless phone comes in three versions:

- With the microphone integrated in the cable
- With the microphone on a boom
- With hearing protection

Connect the headset to the headset connector marked  on the right side of the phone.

21.2.2 Belt Clip

The clip on the back of the phone lets you attach the phone to a belt or similar.

To attach or remove the clip, spread the clip slightly. The ends of the clip fit into the holes on the side of your phone.

21.2.2.1 Attaching a Standard Clip (Hinge Type)

Attach the standard clip as described in figure 16 on page 119.

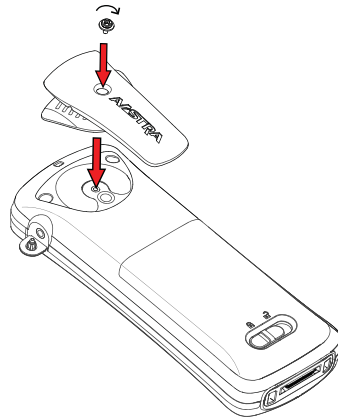

Figure 16: Screw the clip into position

21.2.2.2 Attaching a Security Clip (Swivel Type)

Attach the security (swivel) clip as described in figure 17 on page 119.

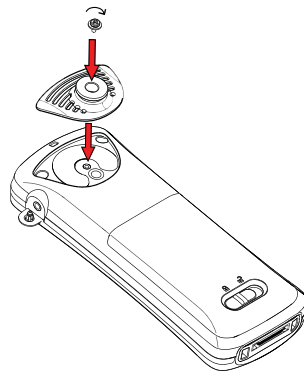

Figure 17: Screw the clip into position

21.2.3 Leather Casing

The leather casing is especially designed for the telephone. The casing comes with a swivel type belt clip and the telephone is fully operational while placed in the casing.

21.2.4 Security String

The 800 mm long security string is attached directly to the phone.

21.3 Chargers

There are different types of chargers available for the cordless phone. They are described in the following sections.

Note: Limit the distance between the mains socket and the cordless phone when charging for easy accessibility.

21.3.1 Desk Charger

The desk charger is used only for charging. The charger is delivered with a plug-in power supply and is connected to a standard wall socket.



Figure 18:Desk Charger

Note: Only use the chargers within the temperature range of 5 - 40° C.

21.3.2 Desk PDM Charger

The desk PDM charger is used for charging the phone, as well as for software download, and synchronization of parameters. The desk PDM charger is delivered with a plug-in power supply and is connected to a standard wall socket.



Figure 19:Desk PDM Charger

Note: Only use the charger within the temperature range of 5 - 40° C.

Using the desk PDM charger for software download and synchronization of parameters is most often done by system administrators, and requires that the charger is connected either to the LAN and CPDM or to a PC with the WinPDM software application installed. For a short description of CPDM and WinPDM, see WinPDM and CPDM on page 125.

The desk PDM charger is connected to a PC through the USB or one of the network connectors, see figure 20 on page 121. When you connect the charger with a PC through one of the network connectors, the charger acts as a switch, making it possible to connect the other connector to the LAN.

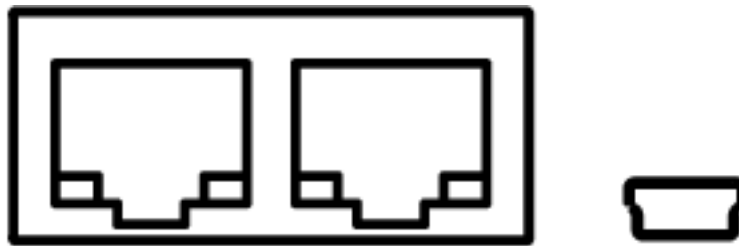

Figure 20: Network and USB Connectors

Note: Network and USB connectors are used to connect the desk PDM chargers to a PC running the WinPDM or to the LAN (not for charging).

21.3.3 Rack PDM Charger

The rack PDM charger is used for charging several phones, as well as for software download, and synchronization of parameters. The built in power supply can charge up to six cordless phones at once.

21.3.4 Battery Pack Rack Charger

The battery pack rack charger is used for charging up to six spare batteries.

21.4 Bluetooth Headset (Optional)

Note: Before you can connect a Bluetooth headset to your phone, Bluetooth functionality must be available in the phone. Bluetooth is factory-mounted on the circuit board of the phone.

The Bluetooth technology replaces the cord between a cordless phone and the headset. This allows the user to move more freely and eliminates the risk of a headset cord getting stuck.

Note: Bluetooth headsets are neither provided with nor sold together with the phone.

The following functions are available:

- Pairing the cordless phone with its headset.
- Choosing the device to use when making a call.
- Playing a ring signal through the Bluetooth headset.
- Answering and connecting sound to the Bluetooth headset when answering with the headset button.
- Ending a call with the Bluetooth headset button.
- Transferring audio to and from the Bluetooth headset during a call, using the menu in the cordless phone.
- Increasing and decreasing the volume in the Bluetooth headset with the volume buttons on the cordless phone.

Note: The Bluetooth headset functions may vary. See your Bluetooth headset manual.

The cordless phone is tested with a number of Bluetooth headsets. Since the Bluetooth supports the Bluetooth 2.0 standard, other headsets may also work although this has not been verified by Aastra.

21.4.1 Using a Bluetooth Headset

For optimal performance, place the Bluetooth headset and the phone on the same side of your body. The best audio quality in the headset is achieved when there is no obstructions, including your body, between the headset and the cordless phone.

21.4.1.1 Activating a Bluetooth Headset

Enabling, disabling, and connecting a Bluetooth headset is explained in Bluetooth on page 109.

Up to four headset can be paired to the phone, but only one at a time can be active. To pair another headset, repeat the steps in Connecting a Bluetooth Headset on page 109.

To activate a Bluetooth headset, do the following:

1. Press **Menu**, select , and press **Select**.
2. Select **Bluetooth**, and press **Select**.
3. Select **Headset**, and press **Select**.
4. Step with the navigation keys to the headset to be connected, **Select**.

When the headset has been connected, the following message is displayed: `Connection successful`.

Note: The current active headset must be deactivated before another headset can be activated.

21.4.1.2

Removing a Bluetooth Headset

To remove a Bluetooth headset, do the following:

1. Press **Menu**, select , and press **Select**.
2. Go to **Bluetooth**, and press **Select**.
3. Select **Headset**, and press **Select**.
4. Use the navigation key to select headset, and press **More**.
5. Select **Delete** and press **Yes**.

21.4.1.3

Changing the Name of the Bluetooth Headset

To change the Bluetooth headset name, do the following:

1. Press **Menu**, select , and press **Select**.
2. Go to **Bluetooth**, and press **Select**.
3. Select **Headset**, and press **Select**.
4. Use the navigation key to select headset, and press **More**.
5. Select **Edit name**, and press **Select**.

21.4.2

Calling With Bluetooth

To make a call with Bluetooth, do the following:

1. Dial the number and press **Call**.

2. the following message is displayed, follow the steps below: Audio i headset. Transfer to phone?
 - Press **No** or ignore the message to use the Bluetooth.
 - Press **Yes** to use the phone.

21.4.3 Answering With Bluetooth

A ring signal sounds both in the active Bluetooth headset and the phone to indicate an incoming call.

- To answer the call from the Bluetooth headset, press the headset button.
- To answer the call from the phone, press .

21.4.4 Ending a Call With Bluetooth

To end a call with Bluetooth, do the following:

- Press the headset button or  on the phone.

21.4.5 Transferring a Call With Bluetooth

It is possible to transfer an ongoing call between the Bluetooth headset and the phone.

To transfer a call with Bluetooth, do the following:

1. Press **More** during a call.
2. Select **Audio transfer** and press **Select**.

Note: It is also possible to transfer a call to the Bluetooth headset by pressing the button on the Bluetooth headset.

21.4.6 Switching from Bluetooth To a Headset With Cord

If a headset with a cord is connected during a call, the call is automatically transferred to the headset.

21.4.7 Operation Notice

Accessibility and Voice quality

Bluetooth uses the frequency of 2.45 GHz. WLAN, microwave oven, and other devices that use the same frequency can disturb the use of a Bluetooth headset.

Operation Area

Maximum distance between the headset and the phone is 10 metres. The communication distance between the phone and headset may vary considerably due to the environment and disturbances from other 2.45 GHz equipment. Different headsets can also give different communication distances.

Out of Range

If a connection cannot be made with the selected Bluetooth headset the call is transferred automatically to the phone. If the Bluetooth headset and the phone get out of range from each other the connection is temporarily lost. Since the last connected headset is always considered “selected”, the connection is automatically established again when a call is made or received.

21.5 WinPDM and CPDM

Software and parameters in the cordless phone can be upgraded by using the WinPDM or the CPDM. This is most often only done by system administrators. The following are examples of additional features that can be downloaded or configured through PDM:

- Call services
- Company phonebook
- Downloadable language
- Customizing the menu structure

WinPDM is used together with the Desk PDM charger. The Desk PDM charger is connected to the PC with WinPDM software through the network or USB connectors at the back of the charger, see figure 21 on page 125.

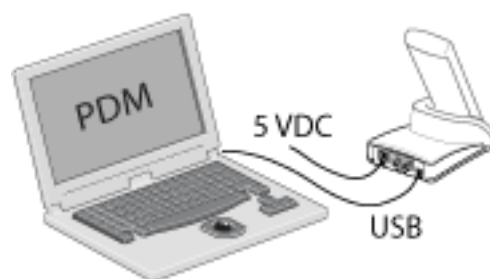

Figure 21: Desk PDM Charger connected to a PC through a USB Connector

For more information on WinPDM and CPDM or upgrading of your cordless phone, contact the system administrator.

22

Troubleshooting

This chapter contains information on how to solve common operational problems, see table 12 on page 126, and warnings, see table 13 on page 126, you may receive. Go through the following lists if you encounter any problems. If the checklists do not solve the problem, contact the system administrator. If others have similar problems, there may be a system error.

Table 12 Operational problems





Fault	Probable cause	Action or comment
No display	The battery level is low or the phone is defective.	Charge the battery.
No ringing	The mute icon  is shown in the display, or ringer volume set to silent, or the phone is defective.	Make a long press on  , or increase volume.
Signal strength icon off	Out of system coverage area or the phone is defective.	Enter coverage area.
Call is switched off after 2 seconds	The phone is defective.	Contact the system administrator.

Table 13 Error or warning messages

Display shows	Probable cause	Action or comment
Enter PIN	The phone's lock is activated.	Enter the required PIN code. If you have lost the PIN code, configure a new or do a factory reset in WinPDM.
No access	The network is in range, but no access rights.	Switch off the phone and then switch it on again.

Display shows	Probable cause	Action or comment
<p>No system The phone beeps once a minute (during max 30 minutes) with a low tone followed by a high tone (if enabled, the vibrator also follows the beeps).</p>	<p>The phone is out of coverage or phone is defective.</p>	<p>Stop the beep by pressing . Then go into range, or contact the system administrator. (When you enter the coverage area again, it takes a few minutes before the phone registers into the system again.)</p>
<p>SERVICE NEEDED Parameters corrupt Note: This display message appears in English only.</p>	<p>The phone is defective.</p>	<p>Select the reset option on the middle soft key and upgrade the phone's software. If no reset option is available, or if the error is not resolved, the phone needs repair. Send the phone to service.</p>
<p>SERVICE NEEDED Invalid IPDI Note: This display message appears in English only.</p>	<p>Easy replacement procedure not followed correctly or failure during easy replacement procedure.</p>	<p>Send the phone to service.</p>
<p>Battery low, charge now</p>	<p>The battery level is low.</p>	<p>Charge or replace the battery.</p>
<p>Enter IPEI</p>	<p>The phone is blocked, that is, if you have entered the wrong PIN code more than three times.</p>	<p>Enter the IPEI code and press .</p>

Display shows	Probable cause	Action or comment
Phonebook is not available at the moment	The phonebook does not respond, not available at the moment.	Try again later. If the error is not resolved, contact the system administrator
Voice mail number not defined	There is no voice mail number defined in the phone.	Define a voice mail number via WinPDM or CPDM. Contact the system administrator.
Could not encrypt connection	The "Encryption Required" parameter is enabled in the phone in combination with either or both of the following options: <ul style="list-style-type: none"> • one or more encrypted base stations • one or more unsupported base stations 	Perform one or more of the following steps: <ul style="list-style-type: none"> • Disable the parameter • Enable the encryption in the base stations • Use the supported base stations. <p>Make sure to use base stations of version 3.1.x or higher</p>

23 Glossary

AC	Authentication code.
Abbreviated number	Short number. Initiating a call to a pre-programmed number by dialing a code or pressing a key.
Conference	If you have an ongoing conversation you can include other persons and establish a phone conference.
CPDM	Centralized Portable Device Manager: A system version with more features than the WinPDM. It runs on a ELISE2 hardware and is manageable from a PC with network communication.
DECT/GAP	Digital Enhanced Cordless Telecommunication/ Generic Access Profile. This means that no one can eavesdrop on your calls and that the quality of speech is as good as that of conventional fixed phones. DECT/GAP enables interoperability with other manufacturers' products.
Desk charger	A charger for the cordless phone.
Desk PDM charger	A charger that also can be connected to WinPDM or CPDM for configuration and upgrading of the cordless phone.
Directory number	Number with 1-8 digits which is assigned to an extension or external line or as a common abbreviated number.
DTMF tone	Dual Tone Multi Frequency or touch tone, for dialing.
Exchange	Switch. Your phone switching system.
Extension number	All phones connected to the PBX have a unique internal number (up to 8 digits). You can see your number on the display.
GAP	Generic Access Profile, a standard for cordless phone systems.
Idle mode	The state your phone is in when nothing is activated; not calling, not ringing, not diverted and so on.

IP call	Internal call sent through an internal data network (LAN or WAN).
IPEI	International Portable part Equipment Identity, unique identity assigned to your phone by the manufacturer.
IPDI	The unique global GAP identity number for the DECT registration. IPDI is exchanged between phones during the easy replacement procedure.
ISDN	Integrated Services Digital Network. Provides your system with supplementary services from the public net.
Least Cost Routing	A function that automatically selects the cheapest way to connect your external call (not necessarily the shortest distance).
PARK	Portable Access Right Key, unique identity assigned to your network.
PBX	Private Branch Exchange. Your phone switching system (for example, MX-ONE).
PIN	Personal Identification Number for security.
Rack PDM charger	A rack charger that also can be connected to WinPDM or CPDM for configuration and upgrading of the cordless phones.
Speed Dialing number	Abbreviated number or short number, used for making frequently used numbers faster to dial.
SW	Here you can see which version of the phone software you have.
Tandem configuration	The tandem configuration is a unit consisting of two phones using the same directory number.
Third party	A third connection (person), which can be included in an ongoing two person conversation. The connection can be internal or external.
WinPDM	A software application for managing the cordless phone. Used to download software, set up parameters, templates and so on.

24 Telephony Function Codes

This chapter describes the country specific function codes used in MX-ONE that are relevant for the cordless phone. The codes are listed in Standard and alternative codes on page 131.

The following application systems are concerned: Australia, Austria, Belgium, Brazil, Canada, China, Denmark, Export, Finland, France, Germany, Hong Kong A-law, Hong Kong My-law, Indonesia, Ireland, Italy, Malaysia, Mexico, The Netherlands, New Zealand, Norway, Korea, Saudi Arabia, Singapore, South Africa, Spain, Standard, Sweden, Switzerland, United Kingdom, and U.S.A.

Suffix codes are entered as written. They can only be used for SIP phones. For H.323 phones dedicated keys are used.

Service codes are entered as **[code]* # for activation, and #*[code]* # for deactivation.

Table 14 Standard and alternative codes

Functions	Codes	
	Standard	Alternative
Suffix digits (only for SIP)		
Alternation on Inquiry	N/A	Sweden: R
Conference	3	
Intrusion	4	France: 8 New Zealand: 8 Sweden: 8
Call Waiting Indication	5	France: 6 New Zealand: 6 Sweden: 4
Call Back	6	France: 5 New Zealand: 5 Sweden: 5
Common Parking or Individual Call Pick-up	8	France: 4 New Zealand: 4 Sweden: 6
Feature Codes		
General Deactivation	001	U.S. and Canada: 0

Choice of Language	08	
Ordering or Cancellation of Active List (Personal Number)	10	
Follow Me	21	United Kingdom: 2
External Follow Me	22	U.S. and Canada: 23
Ordering or Cancellation of Interception Message	23	U.S. and Canada: 24
Print Interception Message	26	Sweden: N/A
Manual Message Waiting	31	
Cancellation of Message Waiting	31	U.S. and Canada: 56
Automatic Call Back, Cancellation	37	U.S. and Canada: 6
Malicious Call Tracing	39	
Calling Line Identification Restriction Per Call	42	
By-pass of Diversion	60	U.S. and Canada: 1
Account Code Predialing	61	Finland: 71 Norway: 71
Authorization Code Predialing	72	Germany: 75 The Netherlands: 75 U.S. and Canada: 6 Sweden: 75
Lock/Unlock Common Authorization Code	73	U.S. and Canada: 71
Change Individual Authorization Code	74	
Dial With Individual Authorization Code	75	Germany: 72 The Netherlands: 72 Sweden: 72
Lock/Unlock Individual Authorization Code	76	

Customer Identity Storage	77	
Answer on Group Call Pick-up, and Answer on Night Time Connection (* and # in the service code can be excluded)	8	Finland: 0 U.S. and Canada: 59 Sweden: 0
Ordering of Night Time Connection	84	U.S. and Canada: 8
Repetition of the Last External Number Dialed	***	Finland: **0 Sweden: **0