

# ***Cordless Telephone*** ***with Answering System***

---

Operating Instructions

**US**

DIGITAL **900** MHz

**CALLER ID**  
with call waiting

*SPP-A985*

## Owner's Record

The model and the serial numbers are located at the bottom of the unit. Record the serial number in the space provided below. Refer to these numbers whenever you call upon your Sony dealer regarding this product.

Model No. SPP-A985

Serial No. \_\_\_\_\_

# IMPORTANT SAFETY INSTRUCTIONS

When using your telephone equipment, basic safety precautions should always be followed to reduce the risk of fire, electric shock and injury to persons, including the following:

1. Read and understand all instructions.
2. Follow all warnings and instructions marked on the product.
3. Unplug this product from the wall outlet before cleaning. Do not use liquid cleaners or aerosol cleaners. Use a damp cloth for cleaning.
4. Do not use this product near water, for example, near a bath tub, wash bowl, kitchen sink, or laundry tub, in a wet basement, or near a swimming pool.
5. Do not place this product on an unstable cart, stand, or table. The product may fall, causing serious damage to the product.
6. Slots and openings in the cabinet and the back or bottom are provided for ventilation. To protect it from overheating, these openings must not be blocked or covered. The openings should never be blocked by placing the product on the bed, sofa, rug, or other similar surface. This product should never be placed near or over a radiator or heat register. This product should not be placed in a built-in installation unless proper ventilation is provided.
7. This product should be operated only from the type of power source indicated on the marking label. If you are not sure of the type of power supply to your home, consult your dealer or local power company.
8. Do not allow anything to rest on the power cord. Do not locate this product where the cord will be abused by persons walking on it.
9. Do not overload wall outlets and extension cords as this can result in the risk of fire or electric shock.
10. Never push objects of any kind into this product through cabinet slots as they may touch dangerous voltage points or short out parts that could result in a risk of fire or electric shock. Never spill liquid of any kind on the product.
11. To reduce the risk of electric shock, do not disassemble this product, but take it to a qualified service personnel when some service or repair work is required. Opening or removing covers may expose you to dangerous voltages or other risks. Incorrect reassembly can cause electric shock when the appliance is subsequently used.
12. Unplug this product from the wall outlet and refer servicing to qualified service personnel under the following conditions:
  - A. When the power cord or plug is damaged or frayed.
  - B. If liquid has been spilled into the product.
  - C. If the product has been exposed to rain or water.
  - D. If the product does not operate normally by following the operating instructions. Adjust only those controls that are covered by the operating instructions because improper adjustment of other controls may result in damage and will often require extensive work by a qualified technician to restore the product to normal operation.
  - E. If the product has been dropped or the cabinet has been damaged.
  - F. If the product exhibits a distinct change in performance.

13. Avoid using a telephone (other than a cordless type) during an electrical storm. There may be a remote risk of electric shock from lightning.
14. Do not use the telephone to report a gas leak in the vicinity of the leak.

## SAVE THESE INSTRUCTIONS

### CAUTION:

To reduce the risk of fire or injury to persons by battery, read and follow these instructions.

1. Use only the following type and size battery pack: Sony BP-T23.
2. Do not dispose of the battery pack in a fire. The cell may explode. Check with local codes for possible special disposal instructions.
3. Do not open or mutilate the battery pack. Released electrolyte is corrosive and may cause damage to the eyes or skin. It may be toxic if swallowed.
4. Exercise care in handling battery pack in order not to short the battery with conducting materials such as rings, bracelets, and keys. The battery or conductor may overheat and cause burns.
5. Charge the battery pack provided with or identified for use with this product only in accordance with the instructions and limitations specified in the instruction manual provided for this product.
6. Observe proper polarity orientation between the battery pack and battery charger.

### INFORMATION FOR GENERAL TELEPHONES

1. This equipment complies with Part 68 of the FCC rules. On the bottom of this equipment is a label that contains, among other information, the FCC certification number and ringer equivalence number (REN) for this equipment. If requested, this information must be provided to the telephone company.
2. The applicable certification jack (connector) USOC-RJ11C is used for this equipment.

3. This equipment is designed to be connected to the telephone network or premises wiring using a compatible modular jack that is Part 68 compliant.

The FCC compliant telephone cord and modular plug is provided with this equipment.

4. The REN is used to determine the quantity of devices that may be connected to the telephone line. Excessive RENs on the telephone line may result in the devices not ringing in response to an incoming call. Typically, the sum of the RENs should not exceed five (5.0). To be certain of the number of devices that may be connected to a line, as determined by the total RENs, contact the local telephone company.
5. If this equipment (SPP-A985) causes harm to the telephone network, the telephone company will notify you in advance that temporary discontinuance of service may be required. But if advance notice isn't practical, the telephone company will notify the customer as soon as possible. Also, you will be advised of your right to file a complaint with the FCC if you believe it is necessary.
6. The telephone company may make changes in its facilities, equipment, operations or procedures that could affect the operation of the equipment. If this happens the telephone company will provide advance notice so you can make necessary modifications to maintain uninterrupted service.
7. If trouble is experienced with this equipment (SPP-A985), for repair or warranty information, please contact Sony Direct Response Center: Tel 1-800-222-7669. If the equipment is causing harm to the telephone network, the telephone company may request that you disconnect the equipment until the problem is resolved.
8. All repairs will be performed in an authorized Sony service station.
9. This equipment cannot be used to party lines or coin lines.
10. This equipment is hearing aid compatible.

### If your telephone is equipped with automatic dialers

When programming emergency numbers and (or) making test calls to emergency numbers:

1. Remain on the line and briefly explain to the dispatcher the reason for the call.
2. Perform such activities in the off-peak hours, such as early morning or late evenings.

## Caution

You are cautioned that any changes or modifications not expressly approved in this manual could void your authority to operate this equipment.

## Note

This equipment has been tested and found to comply with the limits for a Class B digital device, pursuant to Part 15 of the FCC Rules. These limits are designed to provide reasonable protection against harmful interference in a residential installation. This equipment generates, uses and can radiate radio frequency energy and, if not installed and used in accordance with the instructions, may cause harmful interference to radio communications. However, there is no guarantee that interference will not occur in a particular installation. If this equipment does cause harmful interference to radio or television reception, which can be determined by turning the equipment off and on, the user is encouraged to try to correct the interference by one or more of the following measures:

- Reorient or relocate the receiving antenna.
- Increase the separation between the equipment and receiver.
- Connect the equipment into an outlet on a circuit different from that to which the receiver is connected.
- Consult the dealer or an experienced radio/TV technician for help.

# Table of contents

## Getting Started

- 8 Read this first
- 9 Step 1: Checking the package contents
- 10 Step 2: Setting up the base phone
- 13 Step 3: Preparing the battery pack
- 16 Step 4: Entering the area code
- 20 Identifying the parts

---

## Basics

- 24 Making calls
- 28 Redialing
- 29 Receiving calls

---

## Telephone Features

- 32 Speed dialing
- 32 Storing phone numbers and names
- 34 Making calls with speed dialing
- 35 Phone Directory
- 35 Storing phone numbers and names
- 37 Changing a stored name and/or phone number
- 38 Erasing a memory location
- 38 Making calls from the Phone Directory
- 40 Setting the ringer type
- 40 Turning off the ringer of the handset

- 41 Switching the phones during a call
- 41 To switch from the base phone to the handset
- 41 To switch from the handset to the base phone
- 42 Talking between the phones (Intercom)
- 42 To talk from the handset to the base phone
- 42 To talk from the base phone to the handset
- 44 Transferring a call
- 44 To transfer from the base phone to the handset
- 45 To transfer from the handset to the base phone

## Answering Machine Features

- 46 Setting up the answering machine
- 46 Setting the time and day of the week
- 47 Recording the greeting
- 49 Setting the number of rings
- 50 Setting the audible message alert
- 51 Turning on the answering function
- 53 Playing back messages
- 54 Adjusting the speaker volume
- 54 Erasing messages
- 55 Selecting the Announcement Only Mode
- 56 Screening calls
- 56 Turning on/off the screening calls function

- 
- 57 Recording a memo message
  - 58 Operating from an outside phone
  - 58     Setting the remote ID code  
      (security code)
  - 59     Picking up new messages

### **Caller ID Features**

- 60 Understanding the Caller ID  
   service
- 60     When you receive a call
- 61 Looking at the Caller ID list
- 61     Viewing the Caller ID list
- 62     Erasing data from the  
      Caller ID list
- 64 Using the Caller ID list
- 64     Calling back a number from  
      the Caller ID list
- 65     Storing a number of the  
      Caller ID list into the Phone  
      Directory
- 66     To change the number of  
      digits of the phone number
- 68 Using “Caller ID with call  
   waiting” service

### **Additional Information**

- 69 Mounting the base phone on a  
   wall
- 70 Carrying the handset by the belt  
   clip
- 71 Notes on power sources
- 71 Maintenance
- 72 Troubleshooting
- 77 Specifications
- 78 Index

---

Back cover LIMITED WARRANTY

# Read this first

Before you use your phone, you must first set it up. Here's a quick way to set up your phone: Steps 1, 2, 3 and 4.

## Step 1 (page 9)

First, unpack the phone and the supplied accessories.

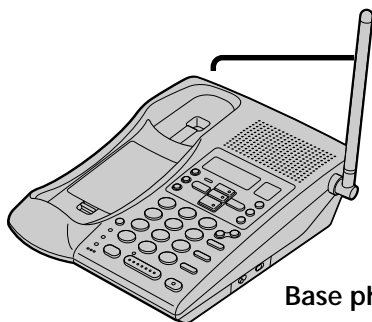

Base phone

## Step 2 (pages 10 to 12)

Next, you need to do three things to set up the base phone, including finding the best location for the base phone.

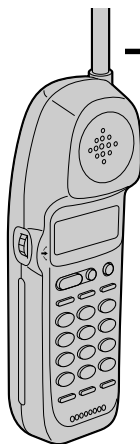

Handset

## Step 3 (pages 13 to 14)

Then, insert the battery pack into the handset and charge it for more than 12 hours.

## Step 4 (pages 16 to 19)

Finally, enter the area code to use the Caller ID service.

***That's it!***



# Step 1

## Checking the package contents

Make sure you have received the following items in the package.  
If anything is missing, contact your local Sony dealer.

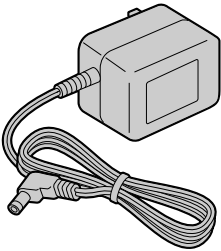

AC power adaptor (AC-T131)

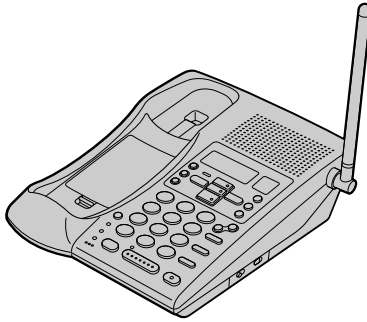

Base phone

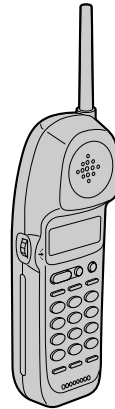

Handset

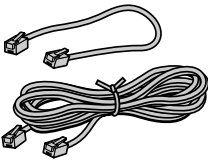

Telephone line cords (2)

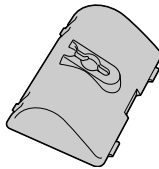

Wall bracket for base phone

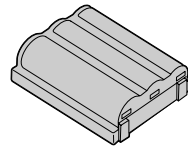

Rechargeable battery pack (BP-T23)

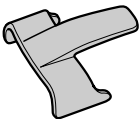

Belt clip



Directories (2)

## Step 2

# Setting up the base phone

Do the following steps:

- Choose the best location
- Connect the base phone
- Choose the dialing mode

## Choose the best location

Where you place the base phone affects the reception quality of the handset.

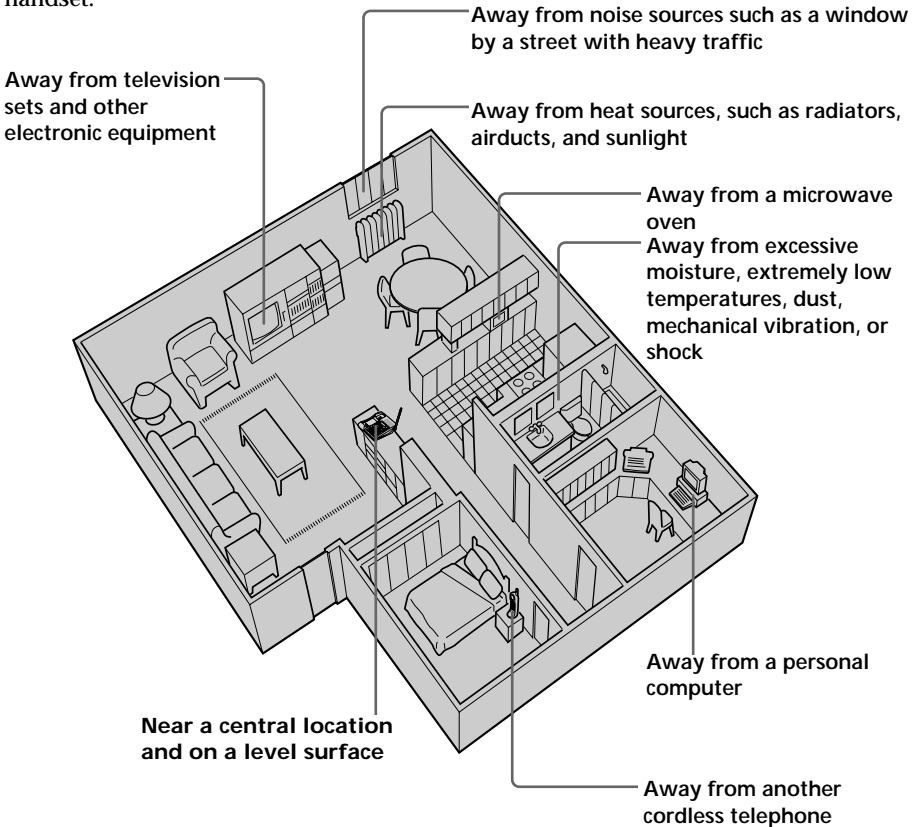

**CAUTION:**

- Should you experience intermittent loss of audio during a conversation, try moving closer to the base or move base phone away from other noise sources.
- The cordless telephone operates at a frequency that may cause interference to nearby TVs and VCRs; the base phone should not be placed near or on the top of a TV or VCR; and, if interference is experienced, moving the cordless telephone farther away from the TV or VCR will often reduce or eliminate the interference.

## Connect the base phone

If you want to hang the base phone on the wall, see page 69.

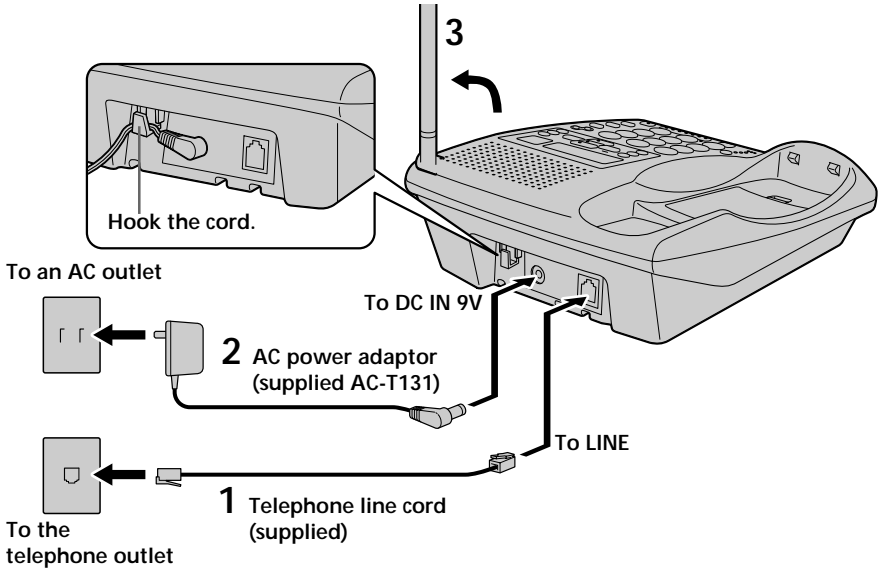

- 1** Connect the telephone line cord to the LINE jack and to a telephone outlet.
- 2** Connect the AC power adaptor to the DC IN 9V jack and to an AC outlet.
- 3** Raise the antenna. Make sure it points towards the ceiling.

**continued**

## Step 2: Setting up the base phone (continued)

### Notes

- Use only the supplied AC-T131 AC power adaptor. Do not use any other AC power adaptor.
- Connect the AC power adaptor to a continuous power supply.
- Place the base phone close to the AC outlet so that you can unplug the AC power adaptor easily.

### Polarity of the plug



### Tip

If your telephone outlet is not modular, contact your telephone service company for assistance.

### Modular



## Choose the dialing mode

For the telephone to work properly, select an appropriate dialing mode (tone or pulse).

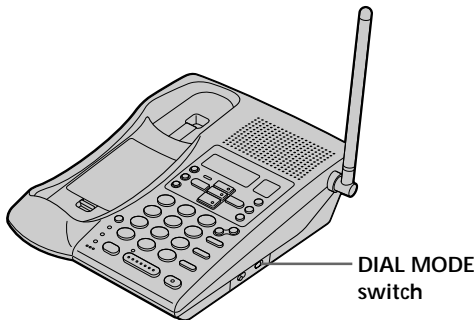

Depending on your dialing system, set the DIAL MODE switch as follows:

If your dialing system is	Set the switch to
Tone	TONE
Pulse	PULSE

### If you aren't sure of your dialing system

Make a trial call with the DIAL MODE switch set to TONE.

If the call connects, leave the switch as is; otherwise, set to PULSE.

## Step 3

### Preparing the battery pack

Charge the battery pack for more than 12 hours before you start using your phone.

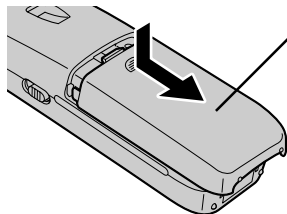
- 

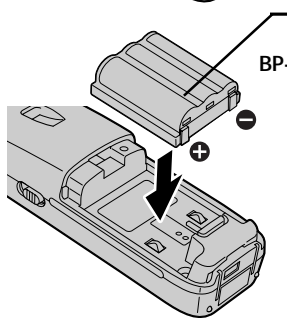
**1** Slide open the battery compartment lid of the handset.
- 

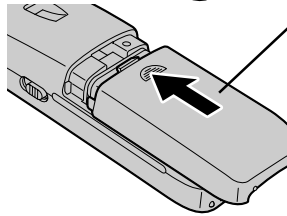
**2** Insert the battery pack (with contacts facing down) into the battery compartment.
- 

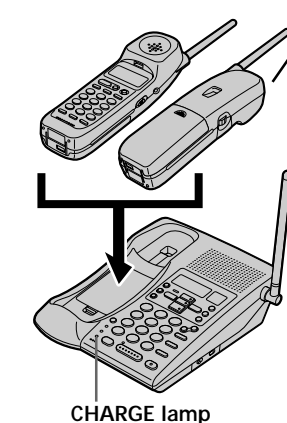
**3** Close the battery compartment lid.
- 

**4** Place the handset on the base phone.  
You can place it with either side facing up.

The CHARGE lamp lights up when the handset is properly seated on the charge terminals of the base phone. Charge the battery pack for more than 12 hours so that the battery is fully charged. The CHARGE lamp remains lit even after charging is completed.

continued

---

## Step 3: Preparing the battery pack (continued)

### Battery duration

A fully charged battery pack lasts for about:

- Approx. 7 hours when you use the handset continuously
- Approx. 7 days when the handset is in standby mode.

### Notes

- The battery pack will gradually discharge over a long period of time, even when not in use.
- If you leave the battery pack in the handset without charging it, the battery pack will be completely discharged.  
It may require several times of charging to recover to its full capacity.

### To obtain the best performance from the battery

Do not place the handset on the base phone after each call. The battery works best if the handset is returned to the base phone after two or three calls. However, do not leave the handset off the base phone for a long period of time as this will completely discharge the battery pack.

### When to purchase a new battery pack

If the battery lasts only a few minutes even after **12 hours** of charging, the usable life of the battery has expired and needs replacement. Contact your local Sony authorized dealer or service center, and ask for a Sony **BP-T23** rechargeable battery pack.

### Note

Battery life may vary depending on usage condition and ambient temperature.

## Handset spare battery usage

As only one battery pack is supplied with this unit, it is necessary to purchase an additional battery pack (optional) for use as a handset spare battery pack.

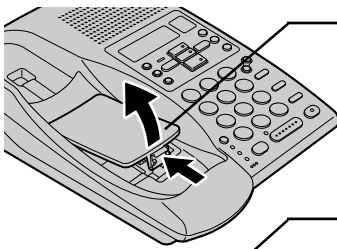

- 1** Open the battery compartment lid of the base phone.

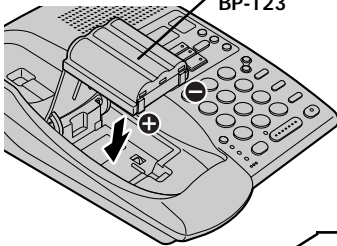

- 2** Insert the battery pack (with contacts facing down) into the battery compartment.

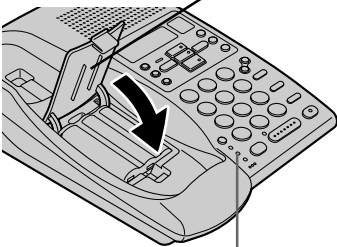

- 3** Close the battery compartment lid.

The SPARE BATT lamp lights up. Charge the battery pack for more than 24 hours so that the battery is fully charged. The SPARE BATT lamp remains lit even after charging is completed.

SPARE BATT lamp

## Step 4

### Entering the area code

When you use this phone for the first time, or move to an area that has a different area code, you must enter your home area code. Otherwise, you cannot use some functions of this phone and the Caller ID functions.

This is also necessary because the phone must be able to select an area code to properly dial call from the Caller ID list.

Depending on your region, enter 3-digit area code as follows:

Case 1.

If 7-digit dialing (no area code) is accepted for local calls in your area, see “To enter your home area code” below.

If you live in an area where calls from or to other local areas can also be made by 10-digit dialing (area code + number), you can register up to 5 local area codes with this telephone to take advantage of this system. See “To enter the local area code (For 10 digits phone number users)” on page 18.

Case 2.

If 10-digit dialing (area code + number) is required for all local calls in your area, at first, enter “000” in your home area code. See “To enter your home area code” below. Then see “To enter the local area code (For 10 digits phone number users)” on page 18.

### To enter your home area code

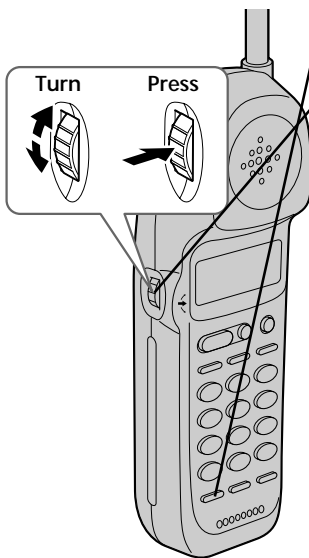

1 Press **PGM**.

2 Turn Jog Dial up to make “AREA” flash.



3 Press Jog Dial.



4 Press Jog Dial again.  
“ENTER AREA CODE” appears on the display.

5 Enter three digits of your home area code using the dialing keys.

6 Press **PGM**.

You will hear a long confirmation beep.



## Notes

- If the home area code is already entered, it appears on the display in step 4. To enter a different home area code, see “To change the home area code” below.
- Do not allow more than 20 seconds to elapse between each step of the procedure.

## Tips

- You may press Jog Dial instead of (PGM) in step 6.
- To check the current home area code, perform steps 1 to 4. The home area code appears on the display for about 20 seconds.

## To change the home area code

**1** Perform steps 1 to 4 on page 16.

The current home area code appears on the display.

**2** Turn Jog Dial down to erase the current home area code.

**3** Enter a new home area code using the dialing keys.

**4** Press (PGM).

You will hear a long confirmation beep.

**continued**

## Step 4: Entering the area code (continued)

### To enter the local area code (For 10 digits phone numbers users)

If a call matches one of the local area codes you entered, the phone number will be registered with 10 digits in the Caller ID list (area code + number). If a call does not match one of the local area codes you entered, the phone number will be registered with 11 digits in the Caller ID list (1 + area code + number). Some regions of the country allow you to have more than one local area code. (Up to five local area codes can be entered in this phone.)

1 Perform steps 1 to 3 on page 16.

2 Turn Jog Dial up to make "LOCAL" flash.



3 Press Jog Dial.

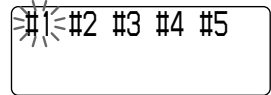

4 Select the number ("#1" to "#5") to enter the local area code by turning Jog Dial.

5 Press Jog Dial.

"ENTER AREA CODE" appears on the display.

6 Enter three digits of the local area code using the dialing keys.

7 Press (PGM).

You will hear a long confirmation beep.

## Notes

- If the local area code is already entered, it appears on the display in step 5. To enter a different local area code, see “To change the local area code” below.
- Do not allow more than 20 seconds to elapse between each step of the procedure.

## Tips

- You may press Jog Dial instead of (PGM) in step 7.
- To check the current local area code, perform steps 1 to 5. The local area code appears on the display for about 20 seconds.

## To change the local area code

- 1 Perform steps 1 to 5 on page 18.

The current local area code appears on the display.

- 2 Turn Jog Dial down to erase the current local area code.
  - 3 Enter a new local area code using the dialing keys.
  - 4 Press (PGM).
- You will hear a long confirmation beep.

## To erase the local area code

You can erase the local area code. Perform steps 1 and 2 above, then press (PGM).

The local area code will be erased, and you will hear a long confirmation beep.

# Identifying the parts

Refer to the pages indicated in parentheses for details.

## Base Phone

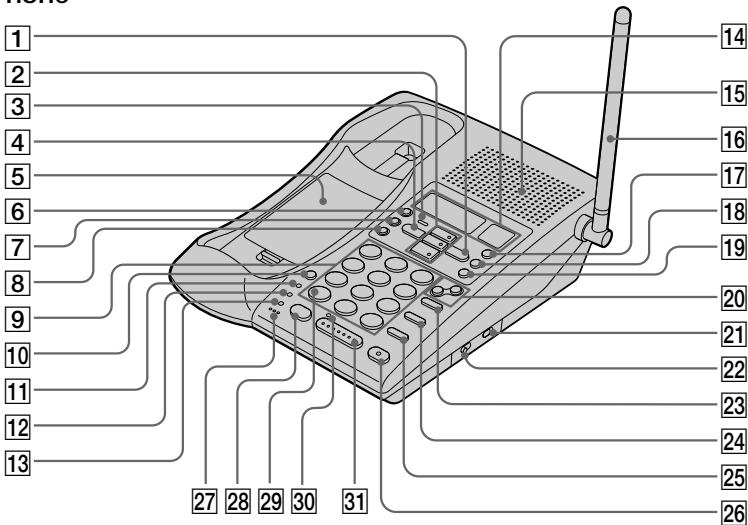

- |  |  |
|--|--|
| <b>1</b> <b>SKIP/QUICK button</b> (p. 53)<br>Press to skip to the next message. Keep the button pressed for quick playback of messages.                                      | <b>8</b> <b>MENU button</b> (p. 46)  |
| <b>2</b> <b>PLAY/STOP (MAILBOX 1, 2, 3) buttons</b> (p. 51, 53)<br>Plays back recorded messages in each mailbox.   | <b>9</b> <b>Dialing keys</b> (p. 24)   |
| <b>3</b> <b>NEW CALL lamp</b> (p. 61)<br>Flashes when there is a "NEW" data in the Caller ID list.   | <b>10</b> <b>PGM (Program) button</b> (p. 32)<br>Used to store numbers for speed dialing.    |
| <b>4</b> <b>REPEAT/SLOW button</b> (p. 53)<br>Press to repeat the current message or go back to the previous message. Keep the button pressed for slow playback of messages. | <b>11</b> <b>LINE lamp</b> (p. 24, 29)<br>Lights when the handset is in use.                 |
| <b>5</b> <b>Battery compartment</b> (p. 15)  | <b>12</b> <b>SPARE BATT lamp</b> (p. 15)<br>Lights while the spare battery is being charged. |
| <b>6</b> <b>TIME/SET button</b> (p. 46, 58)<br>Press when setting the day and time, or to check the current time. Also used when setting the remote ID code (security code). | <b>13</b> <b>CHARGE lamp</b> (p. 13)<br>Lights while the battery is being charged.           |
| <b>7</b> <b>SELECT button</b> (p. 46)  | <b>14</b> <b>Display window</b> (p. 26, 32)  |
|  | <b>15</b> <b>Speaker</b>   |
|  | <b>16</b> <b>Antenna</b> (p. 11, 69)   |
|  | <b>17</b> <b>ANSWER ON/OFF button</b> (p. 51)<br>Turns the answering function on or off.     |
|  | <b>18</b> <b>REC/MEMO button</b> (p. 47, 57)<br>Records a greeting or memo message.          |

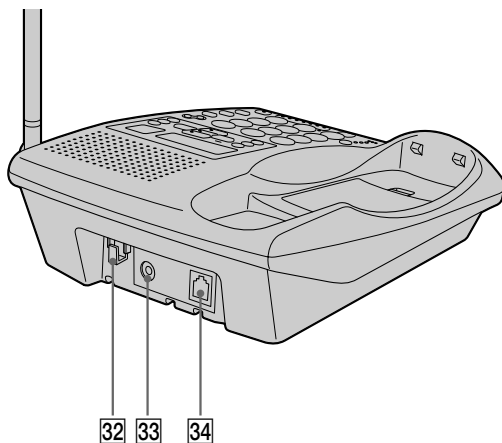

- 19 ERASE button** (p. 48, 54)  
Erases the recorded greeting or messages.
- 20 VOL +/- buttons**  
(p. 26, 32, 54)  
Adjusts the speaker volume or press to move the cursor on the display.
- 21 DIAL MODE switch** (p. 12)  
Selects pulse or tone dialing.
- 22 RINGER LEVEL switch** (p. 31)  
Adjusts the ringer volume.
- 23 REDIAL/PAUSE button**  
(p. 28, 33)  
Redials the last number called/ inserts a pause in the dialing sequence.
- 24 SPEED DIAL button** (p. 32)  
Automatically dials the numbers programmed.
- 25 CALL WAITING/FLASH button**  
(p. 26, 68)  
Switches to a second call if you have "call waiting" service, or lets you make a new call.
- 26 INTERCOM button** (p. 42)  
Lets you talk between the base phone and handset.
- 27 MIC (microphone)** (p. 47, 57)
- 28 HOLD button** (p. 26)  
Puts a call on hold.
- 29 \* TONE button** (p. 26)  
Allows you to switch temporarily to tone dialing.
- 30 SPEAKERPHONE lamp**  
(p. 26)  
Lights while talking through the speakerphone.
- 31 SPEAKERPHONE button**  
(p. 26)  
Lets you make or receive a call.
- 32 Hook for AC power adaptor cord** (p. 11)
- 33 DC IN 9V jack** (p. 11, 69)
- 34 LINE (telephone line) jack**  
(p. 11, 69)

continued

## Identifying the parts (continued)

### Handset

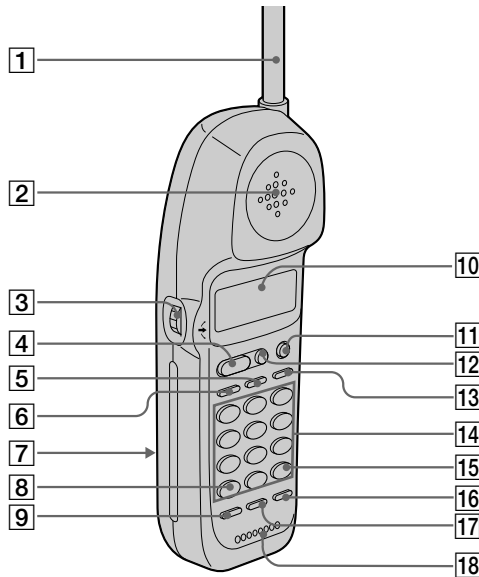

- |   |  |
|---|--|
| <b>1</b> Antenna  | <b>9</b> PGM (Program) button<br>(p. 16, 35)<br>Used to store numbers in Phone Directory.  |
| <b>2</b> Speaker  | <b>10</b> Display window (p. 24, 60)   |
| <b>3</b> Jog Dial (p. 16, 35, 61)   | <b>11</b> CALL WAITING/FLASH button<br>(p. 25, 68)<br>Switches to a second call if you have “call waiting” service, or lets you make a new call. |
| <b>4</b> TALK button (p. 24, 29)<br>Lets you make or receive a call.                  | <b>12</b> OFF button (p. 24)<br>Allows you to disconnect the call.   |
| <b>5</b> INTERCOM button (p. 42)<br>Lets you talk between the base phone and handset. | <b>13</b> REDIAL button (p. 28)<br>Redials the last number called.   |
| <b>6</b> HOLD button (p. 25)<br>Puts a call on hold.                                  | <b>14</b> Dialing keys (p. 24)   |
| <b>7</b> Battery compartment (p. 13)  |  |
| <b>8</b> * TONE button (p. 25)<br>Allows you to switch temporarily to tone dialing.   |  |

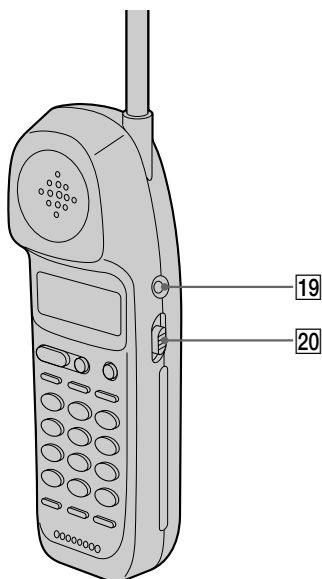

**15 # button** (p. 66)

Used to change the number of digits of the phone number in the Caller ID list.

**16 PAUSE button** (p. 36)

Inserts a pause in the dialing sequence.

**17 MUTING button** (p. 25)

Mutes your voice during a conversation.

**18 Microphone**

**19**  (HEADSET) jack (p. 24, 29, 70)

**20 VOL (volume) switch** (p. 25)

Adjusts the handset volume.

# Making calls

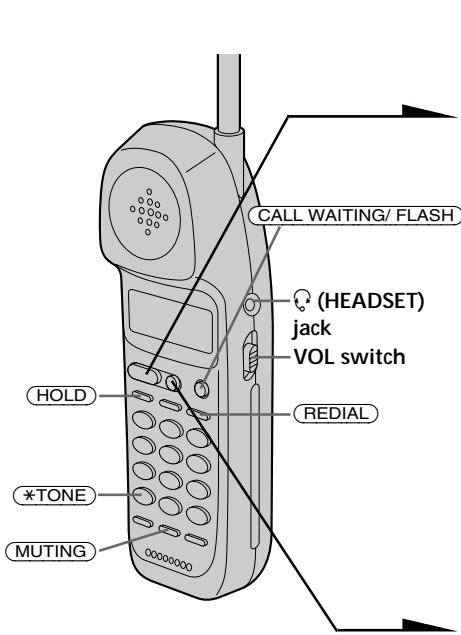

- 1** Pick up the handset from the base phone.
- 2** Press **TALK** and wait until “TALK” appears on the display. The display also shows the talk time in hours, minutes and seconds.  
You will then hear a dial tone. “HANDSET IN USE” appears on the display of the base phone and the LINE lamp on the base phone lights up.  
If “CHANNEL SEARCHING” appears on the display, move closer to the base phone.
- 3** Dial the phone number.
- 4** When you’re done talking, press **OFF** or replace the handset on the base phone.  
The display and the LINE lamp on the base phone go off.

## Making calls when the headset is connected

When the TL-HD1 headset (optional) is connected to the **(HEADSET) jack**, you can talk through the headset.

### Precaution

Avoid listening your headset at so loud a volume that extended play might affect your hearing.



## Additional tasks

To	Do this
Adjust the handset volume	Set the VOL switch to H (high), M (middle) or L (low).
Put a call on hold	Press <b>(HOLD)</b> . "HOLD" appears on the display. Press <b>(HOLD)</b> again to resume the conversation.
Mute your voice	Press <b>(MUTING)</b> to disable the microphone. "MUTING" appears on the display. Press <b>(MUTING)</b> again to cancel.
Switch to another call ("call waiting" service*)	Press <b>(CALL WAITING/FLASH)</b> . Press <b>(CALL WAITING/FLASH)</b> again to return to the first caller.
Switch to tone dialing temporarily	Press <b>(*TONE)</b> after you're connected. The line will remain in tone dialing until disconnected.

\* You need to subscribe to the service from your telephone company.

### Notes

- When you increase the sound volume, in some cases the back ground noise may be increased as well. You should adjust the volume accordingly.
- If your conversation is muted and "CHANNEL SEARCHING" appears on the display, move closer to the base phone; otherwise, the call will be disconnected after one minute.

### If the battery becomes weak during a call

The handset will beep every three seconds five times and **☒** and "BATTERY LOW" appears on the display. Finish your call and charge the battery pack.

### For optimum performance, charge the battery for a full 12 hours.

Note that during the first 10 - 15 minutes of charging, the phone will be inactive, i.e., unable to make or receive a call.

After this initial 10 - 15 minutes, you may be able to use the phone, but the battery duration will be **very short**; thus it is recommended that you **fully charge** the battery before the next usage.

## Making calls (continued)

### If you have a spare battery

You can replace the battery pack without disconnecting the call during a conversation. To replace the battery pack, perform the following procedure.

- 1 Press **(HOLD)** on the handset.  
The call is on hold and “HOLD” appears on the display.
- 2 Replace the battery pack.
- 3 Press **(HOLD)** or **(TALK)** to resume the conversation.

### Making calls through the speakerphone

Press **(SPEAKERPHONE)** on the base phone.

“SPEAKERPHONE” appears on the display and the display also shows the talk time in hours, minutes and seconds.

The SPEAKERPHONE lamp lights up.

Dial the phone number.

When you're done talking, press

**(SPEAKERPHONE)** again.

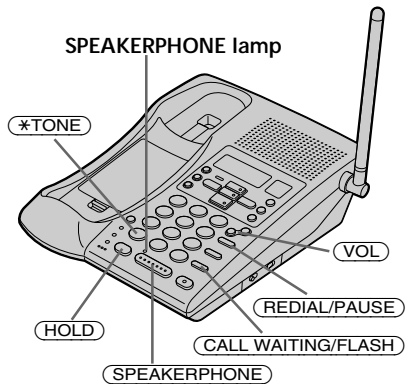

### Additional tasks

To	Do this
Adjust the speaker volume	During speakerphone conversation, press <b>(VOL)</b> <b>(+)</b> or <b>(-)</b> . Each press of <b>(VOL)</b> <b>(+)</b> or <b>(-)</b> switches the speaker volume by one of 8 levels.
Put a call on hold	Press <b>(HOLD)</b> . “HOLD” appears on the display. Press <b>(HOLD)</b> again to resume the conversation.
Switch to another call (“call waiting” service*)	Press <b>(CALL WAITING/FLASH)</b> . Press <b>(CALL WAITING/FLASH)</b> again to return to the first caller.
Switch to tone dialing temporarily	Press <b>(*TONE)</b> after you're connected. The line will remain in tone dialing until disconnected.

\* You need to subscribe to the service from your telephone company.

## Notes

- While conversing with an outside caller via the handset, the display on the base phone shows “HANDSET IN USE”. If you press **(SPEAKERPHONE)** at this time, you can talk to the handset and to the line connected.
- When the talk time exceeds 9:59'59, the display counts from 0:00'00 again.

## To obtain the best speakerphone performance

- You may not be able to hear the other party's voice in a noisy place. Therefore, use the speakerphone in a quiet room.
- Do not bring your hand or other object too close to the microphone or you will hear a shrill noise (“feedback”).
- When the speaker volume is loud, or the base phone has been placed close to a wall, you may find that the volume drops suddenly. This is due to a circuit in the telephone designed to protect against feedback. In such cases, lower the speaker volume slightly.

---

## Making calls (continued)

### Redialing

**1** Press **TALK** and wait until “TALK” appears on the display.

The LINE lamp on the base phone lights up.

If you're at the base phone, press **SPEAKERPHONE**.  
“SPEAKERPHONE” appears on the display and the SPEAKERPHONE lamp lights up.

**2** Press **REDIAL** to redial the last number dialed.

If you're at the base phone, press **REDIAL/PAUSE**.

#### Note

If the number exceeds 32 digits or if it is erased, five short error beeps will alert you that the number cannot be redialed.

#### Tip

The number to be redialed is the last number dialed either on the handset or on the base phone.

### To check the phone number before redialing

When not making a call with either the handset or base phone, press **REDIAL**. If you're at the base phone, press **REDIAL/PAUSE**.

The last number dialed is displayed for five seconds.

To dial the number, press **TALK** while the number is displayed. If you're at the base phone, press **SPEAKERPHONE**.

#### Note

The number will not be displayed if the last number dialed exceeds 32 digits or if it is erased.

### To erase the last phone number dialed

When not conversing with an outside caller with either the handset or base phone, press **REDIAL** twice within five seconds. If you're at the base phone, press **REDIAL/PAUSE** twice.

The number will be erased from the memory, and you will hear a long confirmation beep.

# Receiving calls

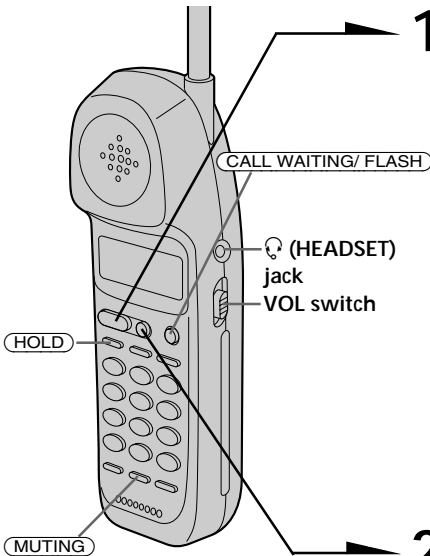

**1** When you hear the phone ring:

- Press **TALK**.

or

- Pick up the handset from the base phone when the handset is placed on the base phone.

“TALK” appears on the display and the display also shows the talk time in hours, minutes and seconds.

“HANDSET IN USE” appears on the display of the base phone and the LINE lamp on the base phone lights up.

**2** When you're done talking, press **OFF** or replace the handset on the base phone.

The display and the LINE lamp on the base phone go off.

## Receiving calls when the headset is connected

When the TL-HD1 headset (optional) is connected to the (HEADSET) jack, you can talk through the headset.

### Precaution

Avoid listening your headset at so loud a volume that extended play might affect your hearing.

## Receiving calls (continued)

### Additional tasks

To	Do this
Adjust the handset volume	Set the VOL switch to H (high), M (middle) or L (low).
Put a call on hold	Press <b>(HOLD)</b> . "HOLD" appears on the display. Press <b>(HOLD)</b> again to resume the conversation.
Mute your voice	Press <b>(MUTING)</b> to disable the microphone. "MUTING" appears on the display. Press <b>(MUTING)</b> again to cancel.
Switch to another call ("call waiting" service*)	Press <b>(CALL WAITING/ FLASH)</b> . Press <b>(CALL WAITING/ FLASH)</b> again to return to the first caller.
Turn on/off the ringer of the handset	See "Turning off the ringer of the handset" on page 40.

\* You need to subscribe to the service from your telephone company.

### Note

If another call comes in by "call waiting" service while conversing with an outside caller, you will hear two short beeps.

### Tip

To inform you of an incoming call, the display shows "\*\* RINGING \*\*" when ringing.

If you have subscribed to the Caller ID service;

- the caller's number and/or name appears on the display when you receive a call (see page 60) or when another call comes in by "call waiting" service.
- the ringer sound changes to a higher tone if the call matches the number stored on speed dialing keys or in the Phone Directory (memory match function; see page 60).

## Receiving calls through the speakerphone

When you hear the phone ring, press **SPEAKERPHONE** on the base phone.

“SPEAKERPHONE” appears on the display and the display also shows the talk time in hours, minutes and seconds.

The SPEAKERPHONE lamp lights up.

When you’re done talking; press **SPEAKERPHONE** again.

To obtain the best speakerphone performance, see page 27.

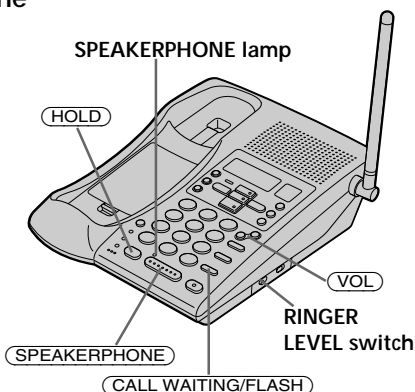

## Additional tasks

To	Do this
Put a call on hold	Press <b>HOLD</b> . “HOLD” appears on the display. Press <b>HOLD</b> again to resume the conversation.
Switch to another call (“call waiting” service*)	Press <b>CALL WAITING/FLASH</b> . Press <b>CALL WAITING/FLASH</b> again to return to the first caller.
Adjust the speaker volume	During speakerphone conversation, press <b>VOL</b> <b>+</b> or <b>-</b> . Each press of <b>VOL</b> <b>+</b> or <b>-</b> switches the speaker volume by one of 8 levels.
Adjust the ringer volume of the base phone	Set the RINGER LEVEL switch on the base phone to HIGH, LOW or OFF.

\* You need to subscribe to the service from your telephone company.

### Note

Even when you set the RINGER LEVEL switch on the base phone to OFF, the handset will ring when the ringer of the handset is turned on (see page 40).

### Tips

- To inform you of an incoming call, the display shows “\*\* RINGING \*\*” and the LINE lamp lights on and off according to the ring signal even when you set the RINGER LEVEL switch on the base phone to OFF.
- If there is an incoming call while on the intercom, the base phone will ring even when the RINGER LEVEL switch on the base phone is set to OFF.

# Speed dialing

You can dial with a touch of a few keys by storing a phone number on a dialing key.

## Storing phone numbers and names

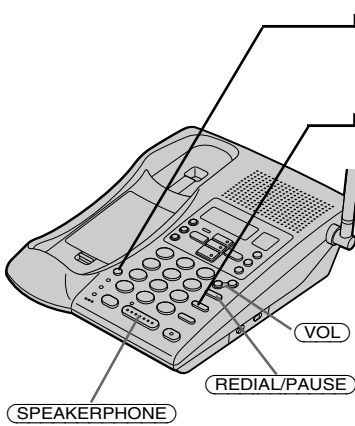

Example: to store “SONY” “123-4567”.

- 1** Press **(PGM)**.  
“PROGRAM” appears on the display.
- 2** Press **(SPEED DIAL)**.  
“ENTER 0 TO 9” appears on the display.
- 3** Press one of the dialing keys (**(0)** to **(9)**) to store a phone number on.



- 4** You will hear a confirmation beep.  
Enter the name using the dialing keys. You can enter up to 16 characters.

Press a dialing key until the desired character appears. (See the character table for details.)

Enter successive characters in the same way.

To enter two characters assigned to the same key, or to enter a “space”, press **(VOL +)** to move the cursor to the right.

Example: to enter “SONY”, press **(7)** four times (S), press **(6)** three times (O), press **(VOL +)** to move the cursor, press **(6)** twice (N), and press **(9)** three times (Y).

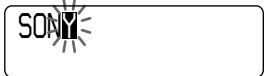

### Character table

Key	Character
<b>(1)</b>	1
<b>(2)</b>	A → B → C → 2
<b>(3)</b>	D → E → F → 3
<b>(4)</b>	G → H → I → 4
<b>(5)</b>	J → K → L → 5
<b>(6)</b>	M → N → O → 6
<b>(7)</b>	P → Q → R → S → 7
<b>(8)</b>	T → U → V → 8
<b>(9)</b>	W → X → Y → Z → 9
<b>(0)</b>	0
<b>(*)</b>	*
<b>(#)</b>	& → ' → , → - → . → #



**5** Press **PGM**.

“ENTER NUMBER” appears.

**6** Enter the phone number.

You can enter up to 32 digits, including a tone and a pause, each of which is counted as one digit.



When the phone number of 17 digits or more has been entered, the phone number appears in two lines.

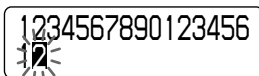

**7** Press **PGM**.

You will hear a long confirmation beep, and the name and the number are stored. The display goes off.

#### Note

Do not allow more than 20 seconds to elapse between each step of the procedure.

#### Tip

If you have entered a wrong name or number in step 4 or 6, press **VOL** **-** to erase it. Then enter the correct name or number.

### To store a number to be dialed via Private Branch Exchange (PBX)

Before entering a phone number in step 6 above, do as follows:

**1** Enter the outside line access digit (e.g., 9).

**2** Press **REDIAL/PAUSE**.

### To change a stored number

Store a new number, as described previously.

continued

---

## Speed dialing (continued)

### Making calls with speed dialing

- 1 Press **SPEAKERPHONE**.
- 2 Press **SPEED DIAL**.
- 3 Enter the desired speed dialing number (**0** to **9**).

The phone number stored as the speed dialing number will be dialed.

### To check the phone number before speed dialing

When not making a call with the base phone, press **SPEED DIAL** and then one of the dialing keys (**0** to **9**).

The number stored on the key appears on the display for five seconds. To dial the number, press **SPEAKERPHONE** while the number is displayed.

# Phone Directory

You can dial a number by scrolling through the Phone Directory, in which up to 50 phone numbers can be stored.

## Storing phone numbers and names

Example: to store "SONY" "123-4567".

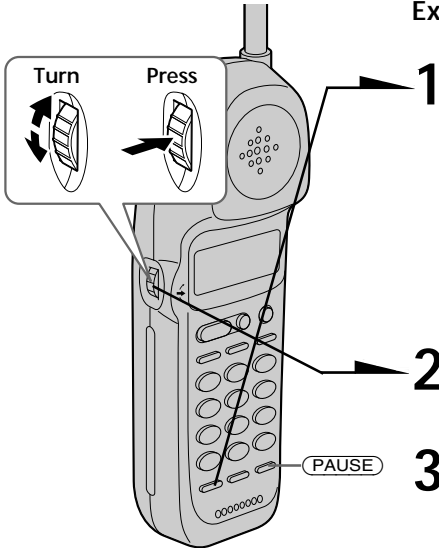

- 1 Press (PGM).  
(Be sure not to press (TALK).)



If "DIRECTORY" is not flashing, turn Jog Dial down to make it flash.

- 2 Press Jog Dial.  
"ENTER NAME" appears.

- 3 Enter the name using the dialing keys.  
You can enter up to 16 characters.

Press a dialing key until the desired character appears. (See the character table for details.)

Enter successive characters in the same way.

To enter two characters assigned to the same key, or to enter a "space", turn Jog Dial up to move the cursor to the right.

Example: to enter "SONY", press (7) four times (S), press (6) three times (O), turn Jog Dial up to move the cursor, press (6) twice (N), and press (9) three times (Y).



### Character table

Key	Character
①	1
②	A → B → C → 2
③	D → E → F → 3
④	G → H → I → 4
⑤	J → K → L → 5
⑥	M → N → O → 6
⑦	P → Q → R → S → 7
⑧	T → U → V → 8
⑨	W → X → Y → Z → 9
⑩	0
*	*
#	& → ' → , → - → . → #

continued

## Phone Directory (continued)

**4** Press **(PGM)**.

“ENTER NUMBER” appears.

**5** Enter the phone number.

You can enter up to 32 digits, including a tone and a pause, each of which is counted as one digit.

When the phone number of 17 digits or more has been entered, the phone number appears in two lines.

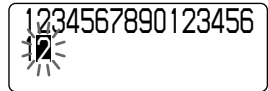

**6** Press **(PGM)**.

You will hear a long confirmation beep, and the name and the number are stored. The display goes off.

### Notes

- If you intend to save a 51st phone number, you will hear five short error beeps and “MEMORY FULL” will be displayed. You cannot store the phone number. To store another phone number, erase one of the stored phone numbers (see page 38).
- Do not allow more than 20 seconds to elapse between each step of the procedure.
- The total number of phone numbers which can be stored into the Phone Directory varies according to the number of digits of each phone number. If all the phone numbers consist of up to 16 digits, you can store up to 50 phone numbers. However, as the Phone Directory uses two-phone number memory to store one phone number of 17 digits or more, the total number of phone numbers which can be stored in the Phone Directory decreases two by two every time you store a phone number of 17 digits or more.

### Tips

- If you have entered a wrong name or number in step 3 or 5, turn Jog Dial down to erase it. Then enter the correct name or number.
- You may press Jog Dial instead of **(PGM)** in steps 4 and 6.

## To store a number to be dialed via Private Branch Exchange (PBX)

Before entering a phone number in step 5 above, do as follows:

**1** Enter the outside line access digit (e.g., 9).

**2** Press **(PAUSE)**.

## Changing a stored name and/or phone number

- 1** Display the name and phone number you want to change by doing steps 1 and 2 in “Making calls from the Phone Directory” on page 38.

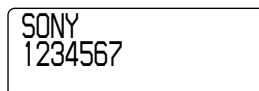

- 2** Press Jog Dial.

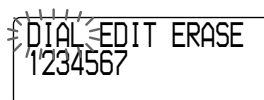

- 3** Turn Jog Dial up to make “EDIT” flash and press Jog Dial.

The cursor flashes at the last character of the name.

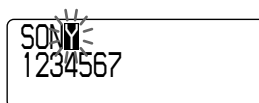

- 4** Turn Jog Dial down to erase the characters and enter the new name.

If you want to change only the number, skip this step.

- 5** Press Jog Dial.

The cursor flashes at the last digit of the phone number.



- 6** Turn Jog Dial down to erase the number and enter the new number.

If you don't want to change the number, skip this step.

- 7** Press Jog Dial.

You will hear a long confirmation beep and the name and/or the number is changed.

### Tip

When the phone number of 17 digits or more has been entered, “-” is displayed next to 15th digit and then the all digits are displayed in two lines after about two seconds.

continued

## Phone Directory (continued)

### Erasing a memory location

- 1 Display the name and phone number you want to erase by doing steps 1 and 2 in “Making calls from the Phone Directory”.

SONY  
1234567

- 2 Press Jog Dial.

DIAL EDIT ERASE  
1234567

- 3 Turn Jog Dial up to make “ERASE” flash and press Jog Dial.

ERASE NO YES  
1234567

- 4 Turn Jog Dial up to make “YES” flash, then press Jog Dial.  
You hear a long confirmation beep and the memory location is erased.

### Making calls from the Phone Directory

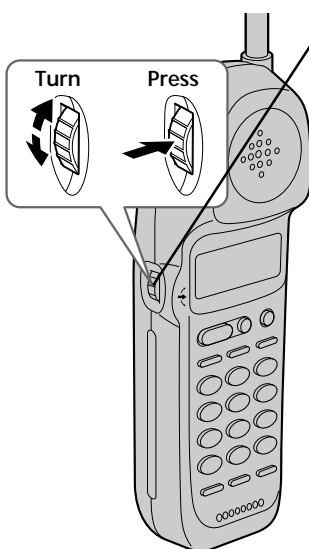

- 1 Press Jog Dial.  
“DIRECTORY” appears on the display.

- 2 Display the name and phone number you want to call.  
**To search in alphabetical order:** Turn Jog Dial up or down.  
**To search by entering the initial character:** Press the dialing key of the desired character, then turn Jog Dial.

SONY  
1234567

- 3 Press Jog Dial.

DIAL EDIT ERASE  
1234567

- 4 Press Jog Dial again.

The phone number will be dialed.

### Tip

You may press **TALK** to make a call instead of doing steps 3 and 4.

### About the search order

The names appear in the following order when you turn Jog Dial up or down.

- Alphabetical order: ABC...XYZ ↔ symbols ↔ \* ↔ # ↔ 0 - 9  

- Initial character: To search for “SONY” for example, press **Z** and then turn Jog Dial to search through the names starting with P, Q, R, S or 7.

# Setting the ringer type

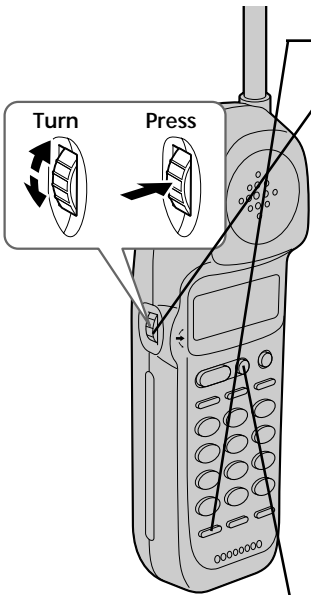
You can select a ringer type of the handset from four type.



**1** Press **PGM**.

**2** Turn Jog Dial up to make “RINGER” flash.



**3** Press Jog Dial.  
The current ringer type appears.



**4** Press one of the dialing keys (**1** to **4**) to select a ringer type.

You will hear the corresponding ringer tone.

**5** Press **OFF**.

## Turning off the ringer of the handset

**1** Perform steps 1 to 3 above.

**2** Press **0**.  
You will hear a confirmation beep.

**3** Press **OFF**.



### When “RINGER” is set to “RINGER OFF”

The handset won't ring. You can still make calls, and also receive calls if another telephone connected to the same line rings to inform you on incoming calls.

### To turn the ringer on again

Follow the instructions described in “Setting the ringer type”.



# Switching the phones during a call

You can easily switch between the handset and speakerphone on the base phone without disconnecting the call.

## To switch from the base phone to the handset

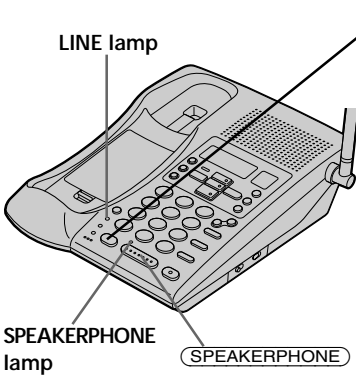

**1** Press **HOLD** on the base phone.

The call is on hold and “HOLD” appears on the display and the **SPEAKERPHONE** lamp on the base phone flashes.

**2** Press **TALK** or **HOLD** on the handset.

You can continue talking to the caller through the handset.

## To switch from the handset to the base phone

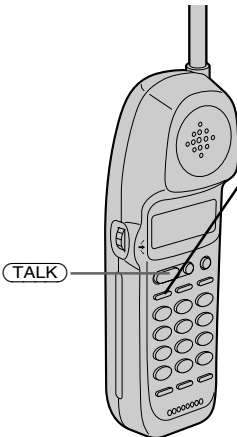

**1** Press **HOLD** on the handset.

The call is on hold and “HOLD” appears on the display and the **LINE** lamp on the base phone flashes.

**2** Press **SPEAKERPHONE** or **HOLD** on the base phone.

You can continue talking to the caller through the speakerphone.

### Tips

- While talking through the speakerphone on the base phone, if you pick up the handset, the call will be switched to the handset.
- When the call is put on hold on the base phone, if you pick up the handset, the call will be switched to the handset.

# Talking between the phones (Intercom)

You can converse using the base phone and the handset. You can start the intercom from either phone.

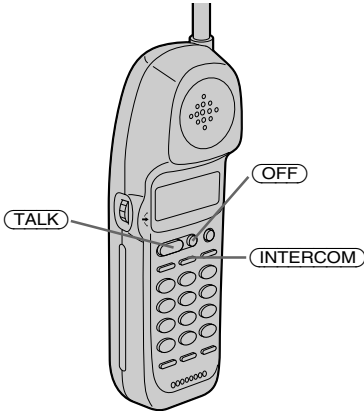

## To talk from the handset to the base phone

Press **INTERCOM** on the handset.

After the base phone rings twice, you will be connected automatically.

When a person at the base phone answers, you can talk with each other.

“INTERCOM” appears on the display.

When you are done talking or if no one answers the phone

Press **OFF** on the handset.

## To talk from the base phone to the handset

Press **INTERCOM** on the base phone.

The base phone and handset ring and “\*\* PAGING \*\*” appears on the display.

When a person at the handset presses **INTERCOM**, you can talk with each other.

“INTERCOM” appears on the display.

When you are done talking or if no one answers the phone

Press **INTERCOM** again.

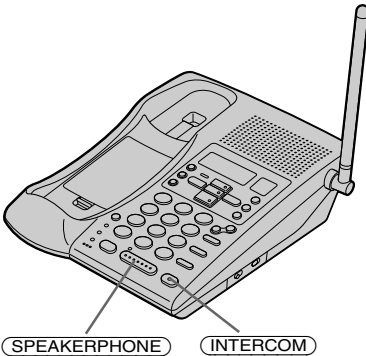

## Notes

- If there's an incoming call while on the intercom, only the base phone rings. To answer the call, press **(SPEAKERPHONE)** on the base phone or **(TALK)** on the handset. The intercom is canceled and you can talk to the outside caller.
- While conversing with an outside caller via the base phone or handset, you cannot make an intercom call. If you press **(INTERCOM)**, you will hear a busy tone.

## Tips

- You can receive an intercom call on the handset even when "RINGER" is set to "RINGER OFF".
- You can receive an intercom call on the base phone even when the RINGER LEVEL switch on the base phone is set to OFF. The base phone will ring at a low level.

# Transferring a call

You can transfer a call between the handset and base phone without disconnecting the call.

## To transfer from the base phone to the handset

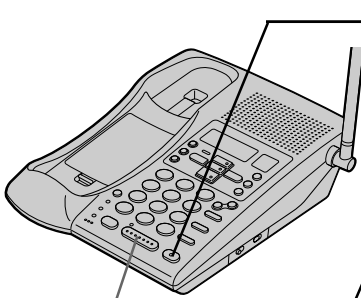

(SPEAKERPHONE)

**1** Press (INTERCOM) to page the handset.

The call is put on hold on the base phone and the handset rings. “\*\* PAGING \*\*” appears on the display of both the base phone and handset.

**2** Press (INTERCOM) on the handset.

“INTERCOM” appears on the display of both the handset and base phone.

You can talk between the base phone and the handset.

**3** Press (TALK) on the handset to talk to the caller with the handset.

“TALK” appears on the display of the handset.

**If no one answers the phone**

Press (SPEAKERPHONE) on the base phone.

### Tips

- You can receive an intercom call on the handset even when “RINGER” is set to “RINGER OFF”. The handset will ring at a low level.
- If you have accidentally pressed (HOLD) in step 1, just press (INTERCOM) and you will get the same result as by pressing (INTERCOM) only.
- The INTERCOM lamp on the base phone flashes during intercom.

## To transfer from the handset to the base phone

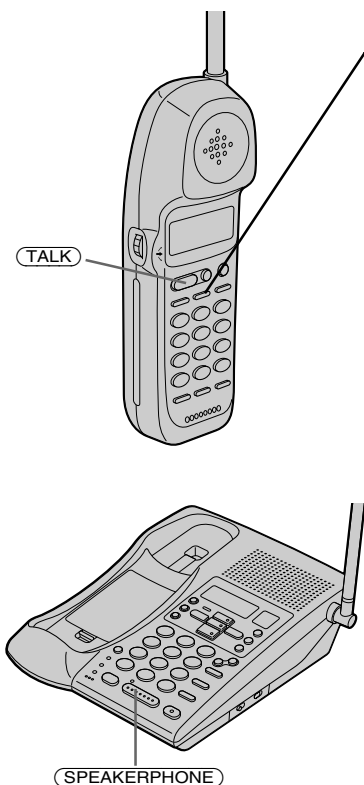

- 1 Press **INTERCOM** to page the base phone.

The call is put on hold on the handset.

After the base phone rings twice, you will be connected automatically.

When a person at the base phone answers, you can talk with each other.

“INTERCOM” appears on the display of both the base phone and handset.

- 2 Press **SPEAKERPHONE** on the base phone to talk to the caller with the base phone.

“SPEAKERPHONE” appears on the display of the base phone.

**If no one answers the phone**

Press **TALK** on the handset.

### Tip

You can receive an intercom call on the base phone even when the RINGER LEVEL switch on the base phone is set to OFF. The base phone will ring at a low level.

# Setting up the answering machine

## Setting the time and day of the week

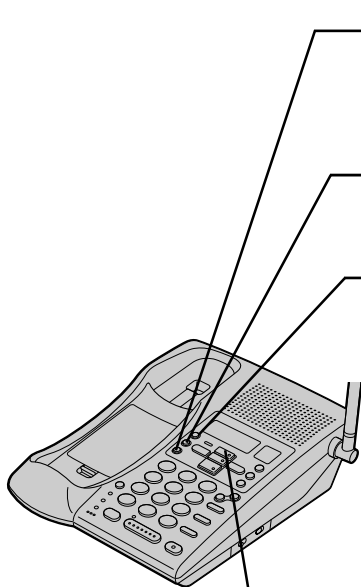

- 1** Press **(MENU)** repeatedly until you hear “Set day and time”. “- -” blinks on the display.
- 2** Press **(SELECT)** repeatedly to select the day of the week.
- 3** Press **(TIME/SET)**. The day is set and the hour is announced.
- 4** Press **(SELECT)** repeatedly to select the hour.
- 5** Press **(TIME/SET)**. The hour is set and the minute is announced.
- 6** Press **(SELECT)** repeatedly to select the minute.
- 7** Press **(TIME/SET)**. The day and time you just entered is announced and the clock restarts.
- 8** Press **(PLAY/STOP)** to exit the menu setup mode. You will hear a long confirmation beep.

### Notes

- Press and hold **(SELECT)** to increase the minute setting by 10.
- The time and day are preset to Monday, 12:00 AM.
- “CL” flashes when the day and time is cleared or delayed due to a power interruption, or when you connect the base phone to the AC outlet for the first time.

**Tip**

All the mailbox buttons (MAILBOX 1, MAILBOX 2 and MAILBOX 3) work as the PLAY/STOP button; press any of the three in this case.

**To hear the current time**

Press TIME/SET. The current time setting is announced.

**Recording the greeting**

You can record your own greeting for the “normal” and “announcement only” modes (see page 55).

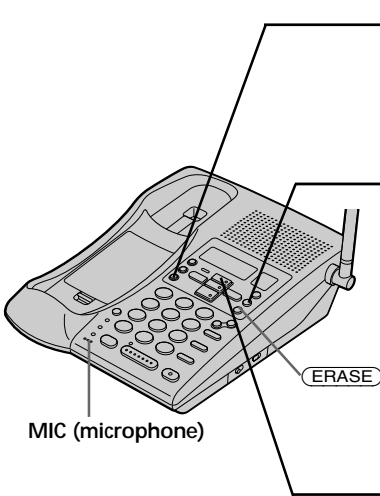

**1** Press MENU repeatedly until “Set out-going message” is announced.

“- -” blinks on the display.

**2** Press REC/MEMO.

“Now recording” is announced and a long beep sounds.

**3** Speak about 12 inches (30 cm) away from the microphone (MIC). The display starts counting. You can record up to 90 seconds.

**4** Press PLAY/STOP to stop recording.

Your greeting replays automatically.

**Notes**

- If you do not record your own greeting, the prerecorded greeting will be assigned automatically (see page 48).
- If your greeting is less than two seconds, the greeting is not recorded. The prerecorded greeting will be assigned automatically.
- If a call comes in during recording, recording stops automatically.
- If 90 seconds have passed or memory becomes full in step 3, recording stops automatically.
- “Memory full” is announced if no recording space is available when you press REC/MEMO. Erase unnecessary messages (see page 54).

**Tip**

To record a greeting for the “announcement only” mode, select the announcement only mode first (see page 55), then follow the instructions above. Otherwise, the normal greeting will be recorded.

---

## Setting up the answering machine (continued)

### To check the greeting

Press **(MENU)** repeatedly until “Set out-going message” is announced. Then press **(PLAY/STOP)** to play back the greeting.

### To change the greeting

Record a new greeting by following the instructions on the previous page. The new greeting replaces the old one.

### To erase the greeting

- 1 Press **(MENU)** repeatedly until “Set out-going message” is announced.
- 2 Press **(ERASE)**.

#### Notes

- You can also erase the greeting during playback.
- If you have erased your own greeting, the prerecorded greeting will be assigned automatically.

### Prerecorded greetings

Normal mode: “Hello, I’m unable to answer your call right now. Please leave your name, number and message after the tone.”

Announcement only mode: “Hello, I’m unable to answer your call right now. Please call again. Thank you.”



## Setting the number of rings

You can select the number of times the phone rings before it answers to take a message.

There are four modes: 2, 4, 6, and Toll Saver.

- 1 Press **(MENU)** repeatedly until you hear “Set number of rings”.  
“- -” blinks on the display.
- 2 Press **(SELECT)** repeatedly to select a ring duration (2, 4, 6, or Toll Saver).  
To answer after 2 rings, select “2”.  
To answer after 4 rings, select “4”.  
To answer after 6 rings, select “6”.  
Select “Toll Saver” to answer after 2 rings when there are new messages, and 4 rings where there are no new messages.
- 3 Press **(TIME/SET)**.  
The ring duration setting is announced.
- 4 Press **(PLAY/STOP)** to exit the menu setup mode.

### Notes

- When the number of rings is set to “Toll Saver”, the phone answers after 2 rings if new messages are recorded. If no new message are recorded, it answers after 4 rings. When you hear 3 rings, you will know that there are no new messages. You can save the toll for the call when you pick up messages from an outside phone.
- The number of rings is preset to 4 rings.

continued

## Setting up the answering machine (continued)

### Setting the audible message alert

You have the option of having a beep tell you if you have received any new incoming messages.

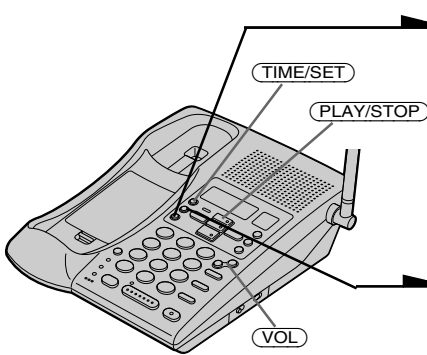

**1** Press **(MENU)** repeatedly until you hear “Set audible message alert”.  
“- -” blinks on the display.

**2** Press **(SELECT)** to set the audible message alert on or off.

**3** Press **(TIME/SET)**.  
The setting is announced.

**4** Press **(PLAY/STOP)** to exit the menu setup mode.

#### Notes

- When the audible message alert is turned on, you will hear a beep every 10 seconds if there are any new messages.
- To stop the beep, press any button related to the answering machine function.
- The audible message alert is preset to off.

## Turning on the answering function

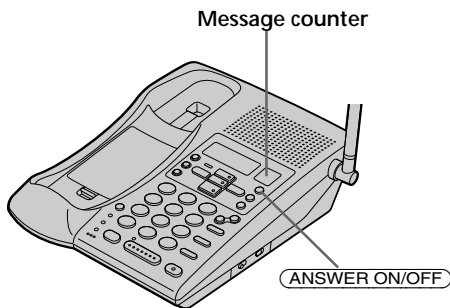

Press **ANSWER ON/OFF** on the base phone.  
The ANSWER ON/OFF button lights up.

## Mailbox usage

This phone offers you three voice mailboxes, providing a convenient way to share the mailbox feature with other members of your household or business.

### When a caller calls

The caller can choose one of the two ways to leave a message:

- If calling from a touch-tone phone, the caller select a mailbox by pressing **\* 1** (MAILBOX 1), **\* 2** (MAILBOX 2) or **\* 3** (MAILBOX 3) while the caller hears the greeting. The greeting stops and a beep will sound, then the caller can start recording a message
- Wait until the greeting finishes, then start recording a message.  
When the caller does not select a mailbox, the message is automatically recorded to MAILBOX 1.

### Notes

- If four minutes have passed while recording the incoming message, the line will be disconnected automatically.
- If the message is shorter than two seconds, it will not be recorded.

### To turn off the answering function

Press **ANSWER ON/OFF** on the base phone.

The ANSWER ON/OFF button goes off.

continued

---

## Setting up the answering machine (continued)

### Note

The answering function is preset to on.

### Tip

The answering machine will automatically answer a call after 10 rings, even if the answering function is off and announces “Please enter your security code” to prompt the caller to turn on the answering function.

### When the memory is full

The total recording time of this answering machine is approximately 15 minutes (including the greeting, messages, and memo).

When the remaining recording time becomes less than 30 seconds, “F” flashes on the display and the answering machine goes into the memory full status.

In this status, the answering machine will not answer a call until after 10 rings even if the answering function is on.

To avoid this erase unnecessary messages (see page 54). You can also erase the messages from an outside phone (see page 59).

# Playing back messages

If there are new messages, the display flashes the number of new messages.

You will hear beeps if the audible message alert setting is on (see page 50).

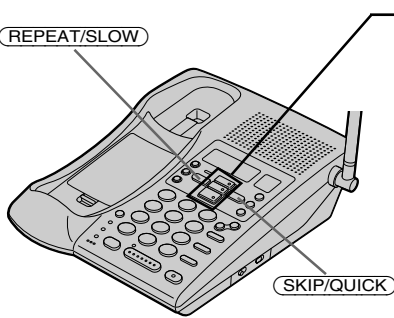

Press a mailbox button ((MAILBOX 1), (MAILBOX 2) or (MAILBOX 3)) to play back new messages in the selected mailbox.

## Additional tasks when playing back messages

To	Do this
Stop playback	Press a mailbox button ((MAILBOX 1), (MAILBOX 2) or (MAILBOX 3)).
Repeat the current message	Press (REPEAT/SLOW) during play back.
Skip the current message	Press (SKIP/QUICK).
Go back to the previous message	Press (REPEAT/SLOW) within the first two seconds of the current message playback.
Play back slowly	Press and hold (REPEAT/SLOW) during play back. Release (REPEAT/SLOW) to return to normal.
Play back quickly	Press and hold (SKIP/QUICK) during play back. Release (SKIP/QUICK) to return to normal.

### Notes

- If a call comes in, the play back will stop.
- A time and day stamp is announced after each message.

### Tips

- If there are no new messages, all the previously reviewed messages are played back.
- The messages are saved even after a power failure.

continued

---

## Playing back messages (continued)

### Adjusting the speaker volume

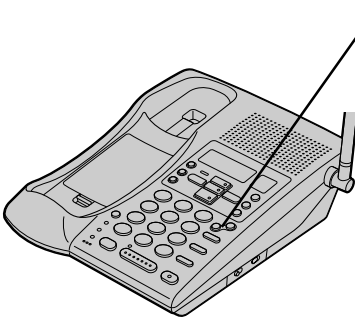

To adjust the speaker volume, press **(VOL)** **(+)** or **(-)**.

#### Notes

- When you have reached the minimum or maximum volume level, you will hear three short beeps.
- You cannot adjust the speaker volume while the phone is ringing.

#### Tip

There are 8 steps for the volume level (1 to 8). The volume level is preset to 5.

### Erasing messages

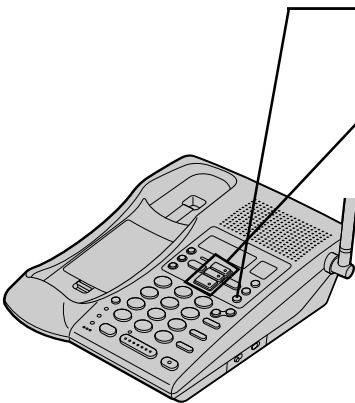

**1** Press and hold **(ERASE)** for more than two seconds.

**2** Press a button for the mailbox you want to erase (**(MAILBOX 1)**, **(MAILBOX 2)** or **(MAILBOX 3)**). You will hear a long confirmation beep and all “old” messages in the selected mailbox are erased.

### To erase individual messages

Press **(ERASE)** while playing back the message that you want to erase.

#### Note

The display shows the total number of “new” (i.e. unreviewed) messages. Therefore, the display is reset to “0” when you have played back all new messages, whether they have been erased or not. Be sure to erase unnecessary messages before the memory becomes full.

# Selecting the Announcement Only Mode

You can set the answering machine to play the greeting without recording incoming messages (announcement only mode). You might want to select this mode when, for example, you expect to be away for a while and you cannot pick up messages.

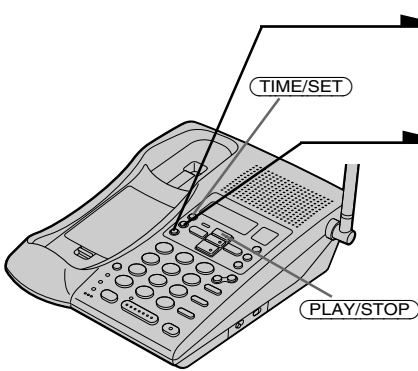

- 1 Press **(MENU)** repeatedly until you hear “Set announce only”.
- 2 Press **(SELECT)** to set the announcement only mode on or off.
- 3 Press **(TIME/SET)**. The setting is announced.
- 4 Press **(PLAY/STOP)** to exit the menu setup mode. The display shows “A” when the answering machine is set to the announcement only mode.

## Notes

- To activate announcement only mode, you have to turn on the answering machine.
- The announcement only mode is preset to off.

# Screening calls

You can screen calls by leaving the answering machine on while you are at home. When a call is answered, you can hear the message being recorded through the base phone. You can decide either to continue recording or to answer the call.

Alternatively, you may select to mute the message (see “Turning on/off the screening calls function” below).

The message will be recorded, but to hear it you will need to play back the message (see page 53).

## To answer the call

Press **TALK** on the handset.

### Notes

- Press **VOL** **+** or **-** to adjust the speaker volume. If the speaker volume is set at its minimum level, you will not be able to hear incoming calls.
- The answering machine will stop automatically when the handset or a parallel phone is picked up. If the answering machine does not stop, press either **PLAY/STOP** on the base phone, or **\* 0** on the handset or parallel phone. The recording will remain as a new message.

## Turning on/off the screening calls function

The screening calls function is preset to on at the factory.

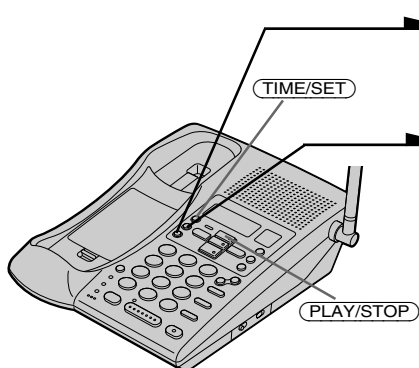

- 1** Press **MENU** repeatedly until you hear “Set call screening”.
- 2** Press **SELECT** to set the screening calls function on or off.
- 3** Press **TIME/SET**. The setting is announced.
- 4** Press **PLAY/STOP** to exit the menu setup mode.



# Recording a memo message

You can leave messages for other users of the unit.

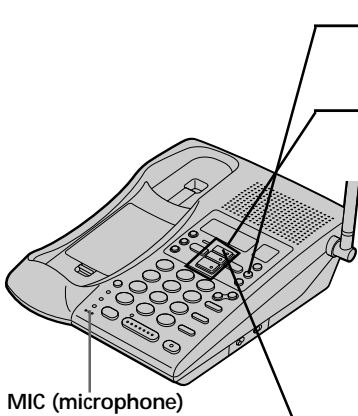

- 1** Press **REC/MEMO**.
- 2** Press a mailbox button (**MAILBOX 1**, **MAILBOX 2** or **MAILBOX 3**) to which you want to leave the message. “Now recording” is announced and counting starts.
- 3** Speak about 12 inches (30 cm) away from the microphone (MIC) to record your message. A memo can be up to four minutes in length.
- 4** Press **PLAY/STOP** to stop recording.  
The message number on the display increases by one.

## Notes

- If the memory becomes full, the answering machine will stop recording.
- “Memory full” is announced if no recording space is available when you press **REC/MEMO**.
- If your message is shorter than two seconds, the recording will be canceled.
- The display flashes “99” if you record a memo for more than 99 seconds.
- If a call comes in during recording, the recording will be stopped.

# Operating from an outside phone

## Setting the remote ID code (security code)

To operate the answering machine from a touch-tone phone while you are away from home, you need to set the remote ID code (security code).

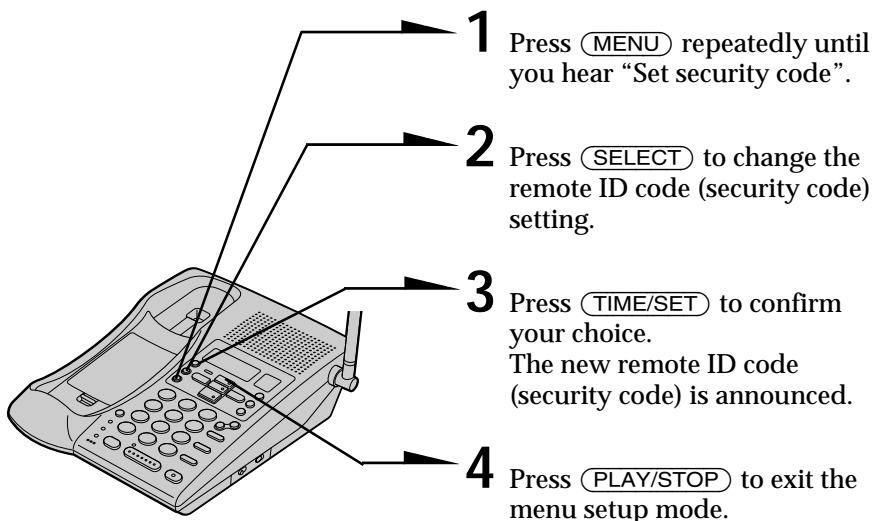

**1** Press **(MENU)** repeatedly until you hear “Set security code”.

**2** Press **(SELECT)** to change the remote ID code (security code) setting.

**3** Press **(TIME/SET)** to confirm your choice.  
The new remote ID code (security code) is announced.

**4** Press **(PLAY/STOP)** to exit the menu setup mode.

### Note

Press and hold **(SELECT)** to increase the remote ID code (security code) by 10.

## Picking up new messages

- 1 Call your telephone number from a touch-tone phone.
- 2 When you hear the greeting, press **(#)** and enter your remote ID code (security code).  
You will hear a confirmation beep.  
The number of new messages will be announced.
- 3 Press the keys in the “Table of control codes” below for the desired operation command.
- 4 When you are finished, disconnect the line.

### Notes

- Do not let two seconds elapse between each digit of the remote ID code (security code) and the control code.
- If you did not turn on the answering machine, your phone answers automatically after 10 rings.
- If the message recording memory runs out, the answering machine turns off automatically. “Memory full. Please enter your security code” is announced.
- If you enter wrong remote ID code (security code) three times, the line will disconnect.
- If no keys are pressed within 20 seconds, the line will disconnect.

### Tips

- Press **(\*)** **(0)** on the touch-tone keypad or **(PLAY/STOP)** on the base phone to disconnect the line.
- Cut off the Remote Control Card and carry it with you to see how to operate from an outside phone.

## Table of control codes

To	Key	Notes
Play back messages in MAILBOX 1	<b>(#)</b> <b>(1)</b>	Plays back from the first new message.
Play back messages in MAILBOX 2	<b>(#)</b> <b>(2)</b>	Plays back from the first new message.
Play back messages in MAILBOX 3	<b>(#)</b> <b>(3)</b>	Plays back from the first new message.
Repeat/skip backward	<b>(#)</b> <b>(4)</b>	Press during play back to repeat a message. To skip backward, press within two seconds after the current message starts.
Get help	<b>(*)</b> <b>(5)</b>	Press to access simple voice menu. Press again to access advanced voice menu.
Stop operation	<b>(#)</b> <b>(5)</b>	Stops every function
Skip forward	<b>(#)</b> <b>(6)</b>	Press during play back to skip forward.
Record greeting	<b>(*)</b> <b>(7)</b>	“Now recording” is announced.
Check greeting	<b>(#)</b> <b>(7)</b>	Review your greeting
Record a memo	<b>(*)</b> <b>(8)</b>	Select the mailbox by entering “1”, “2” or “3”.
Erase individual messages	<b>(#)</b> <b>(9)</b>	Press during play back
Turn answering machine on/off	<b>(#)</b> <b>(0)</b>	Turns the system on/off. “Answer machine on” or “Answer machine off” is announced.

# Understanding the Caller ID service

Caller ID allows the caller's phone number to be shown on the display before the call is answered. In order to use this feature, you must first subscribe to the Caller ID service. The name of this service may vary depending on your telephone company.

To use this feature, be sure to enter your home area code (see page 16).

## When you receive a call

The phone number appears on the display with the date and time\* as shown in the following example.

If your Caller ID service includes the caller name service, the caller's name also appears on the display (up to 15 letters).

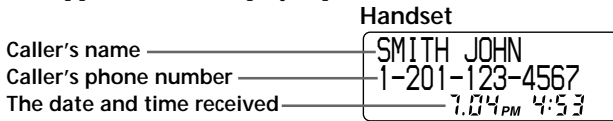

\* The display on the base phone does not show the date and time.

When you answer the call, the Caller ID display changes to the "TALK" or "SPEAKERPHONE" display.

### Notes

- The caller's phone number and/or name will not appear in the following cases:
  - "OUT OF AREA": when the call is made through a telephone company which does not offer Caller ID service (including international calls).
  - "PRIVATE": when the call is "blocked." For privacy reasons, many states allow callers the option to prevent his or her telephone data from being displayed on the other party's Caller ID display.
- If the call is from an office which uses multiple lines, the displayed phone number may not match the number you use to call the extension.

### Tip

Even if the ringer of the handset is set to "RINGER OFF", you can receive Caller ID data.

## About the memory match function

If you receive a call from a phone number which is stored on speed dialing keys (see page 32) or in the Phone Directory (see page 35), the ringer sound will change to a higher tone from the second ring.

### Note

The memory match function does not work with "OUT OF AREA" or "PRIVATE" calls; and it may not work with calls made from an office which uses multiple lines because the number does not always match the one you stored in this phone.

# Looking at the Caller ID list

The phone stores the data of the last 20 calls received including “OUT OF AREA” and “PRIVATE” calls. It keeps track of all calls received; even if they were not answered.

## Viewing the Caller ID list

You can look through the Caller ID list to check the phone number and/or name of the calls received on the handset’s display. Note that the display on the base phone shows the current caller’s phone number and/or name only, and you cannot view the caller ID list on the base phone.

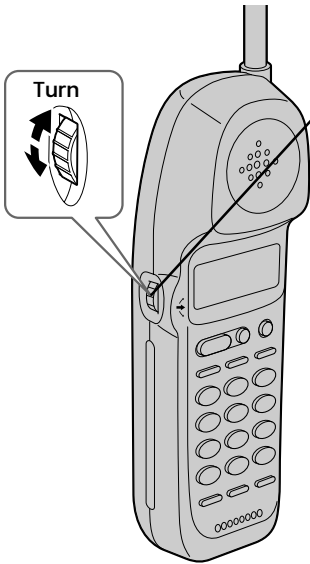

- 1** Turn Jog Dial.  
The display shows the number of “NEW” (calls which you have not viewed) and “OLD” (calls which you have viewed) calls.

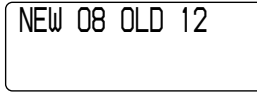

- 2** Turn Jog Dial down to display older data or up to display newer data.

**Note**  
If a 21st call is received, the oldest data is automatically erased.

**Tip**  
If there is a “NEW” data, the NEW CALL lamp of the base phone flashes.

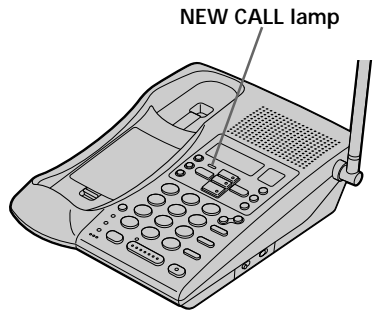

## Looking at the Caller ID list (continued)

### About the “\*” mark

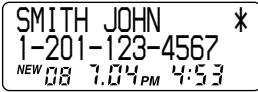

“\*” appears if there are more than two calls from the same phone number. The older data will be replaced by the new data, so the calls are counted as only one call.

## Erasing data from the Caller ID list

Old data will be erased automatically when a 21st call comes in, but you can also manually erase unnecessary data one by one or erase the entire list.

### To erase the phone number one by one

- 1 Display the phone number you want to erase from the Caller ID list (see page 61).
- 2 Press Jog Dial.
- 3 Turn Jog Dial up to make “ERASE” flash and press Jog Dial.
- 4 Turn Jog Dial up to make “YES” flash, then press Jog Dial.  
You will hear a long confirmation beep and the data is erased.

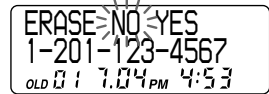
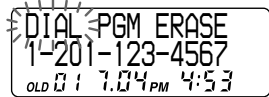
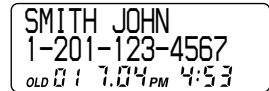

To erase the entire list at once

1 Display any Caller ID data.



2 Press Jog Dial.

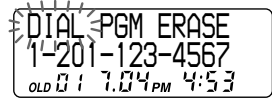

3 Turn Jog Dial up to make “ERASE” flash and press Jog Dial.

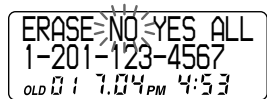

4 Turn Jog Dial up to make “ALL” flash, then press Jog Dial.

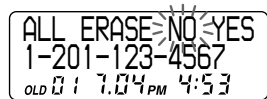

5 Turn Jog Dial up to make “YES” flash, then press Jog Dial.



You will hear a long confirmation beep and the entire list is erased.

Note

“ALL” appears only when all the data has become “OLD” data. If there is any “NEW” data, you cannot erase the entire list.

# Using the Caller ID list

By using the Caller ID list, you can call back a phone number from the Caller ID list easily, or store numbers from the Caller ID list into the Phone Directory.

## Calling back a number from the Caller ID list

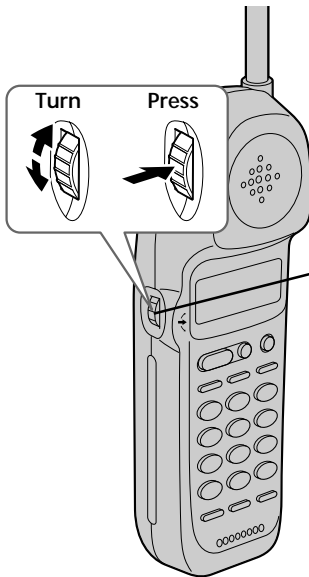

- 1 Display the phone number you want to call from the Caller ID list (see page 61).

SMITH JOHN  
1-201-123-4567  
NEW 08 7:04 PM 4:53

- 2 Confirm the number and press Jog Dial.

DIAL PGM ERASE  
1-201-123-4567  
NEW 08 7:04 PM 4:53

- 3 Press Jog Dial again.  
The phone automatically dials the displayed number.

### Notes

- If the number displayed in step 1 is not the one you should call back, you can change the number of digits of the phone number as described on page 66.
- If the phone is connected to a Private Branch Exchange (PBX), you may not be able to call back from the Caller ID list because an outside line access digit is necessary.

### Tip

You may press **TALK** to make a call instead of doing steps 2 and 3.



## Storing a number of the Caller ID list into the Phone Directory

- 1 Display the name and phone number you want to store from the Caller ID list (see page 61).



- 2 Confirm the number and press Jog Dial.

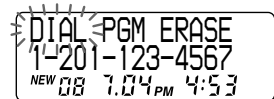

- 3 Turn Jog Dial up to make "PGM" flash and press Jog Dial.

The cursor flashes at the end of the name.

Enter or change the name, if necessary (see page 37).



- 4 Press Jog Dial.

The cursor flashes at the end of the phone number.

Enter or change the phone number, if necessary (see page 37).



- 5 Press Jog Dial again.

You will hear a long confirmation beep and the name and number are stored.

### Notes

- Do not allow more than 20 seconds to elapse between each step of the procedure.
- If the number displayed in step 1 is not the one you should store, you can change the number of digits of the phone number as described on page 66.
- If the phone is connected to a Private Branch Exchange (PBX), you may need to add an outside line access digit.

continued

## Using the Caller ID list (continued)

### To change the number of digits of the phone number

If the number of digits of the phone number in the Caller ID list is different from the actual phone number, you need to adjust the number of digits of the phone number to call back or store into the Phone Directory.

- 1 While the phone number from the Caller ID list is displayed, press **(#)** repeatedly until the phone number with the correct number of digits appears on the display.

Each time you press **(#)**, the number of digits changes as follows:

**When the home area code and the local area code do not match**

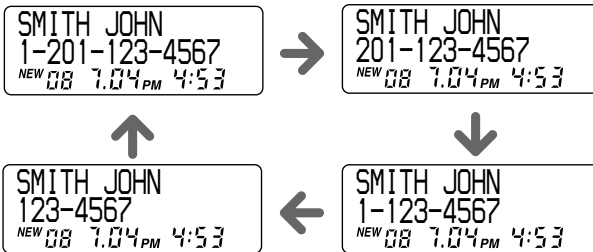

**When the home area code matches**

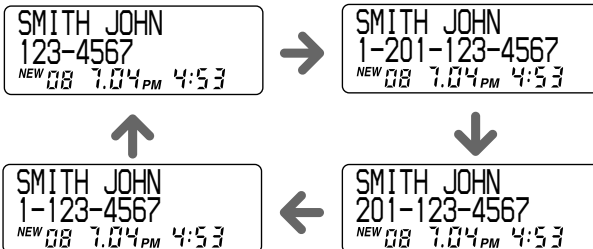

When the local area code matches

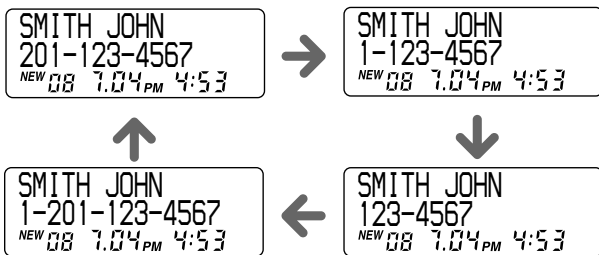

**2** Continue the operation to call or store the phone number with the correct number of digits (pages 64 and 65).

Notes

- You need to adjust the number of digits each time you call back from the Caller ID list as the changes to the Caller ID data is not stored in memory.
- You may not be able to change the number of digits depending on the Caller ID data.

---

# Using “Caller ID with call waiting” service

This telephone is compatible with the “Caller ID with call waiting” service. Make sure that your telephone company offers this service.

Like the basic Caller ID service, you need to subscribe to “Caller ID with call waiting” in order to use this service.

**Even though you may have already subscribed to “Caller ID” and “call waiting” as two separate services, you need to request a subscription to “Caller ID with call waiting” as a single service.**

This is a new service that combines the two services.

**Even though you now have a “Caller ID with call waiting” compatible phone, unless you subscribe to the combined “Caller ID with call waiting” service, you will not be able to see the name and number of the second caller.**

When a new call comes in while you are talking, you hear two short beeps. The caller’s name and/or phone number of the new call appears on the display for about 20 seconds.

## To switch to another caller



**1** To switch to the new caller, press **CALL WAITING/ FLASH**.

**2** To switch back to the first caller, press **CALL WAITING/ FLASH** again.

# Mounting the base phone on a wall

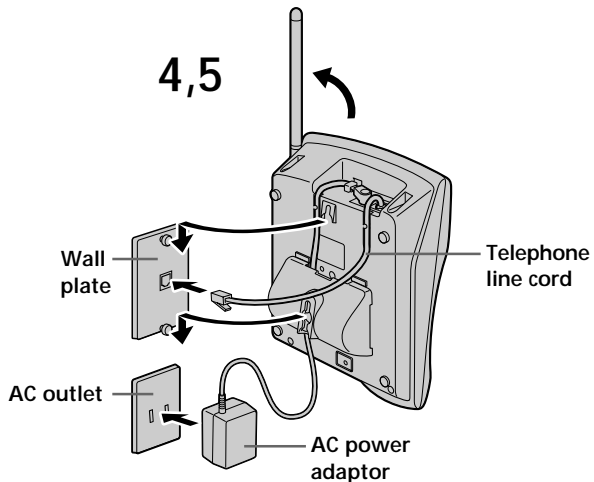
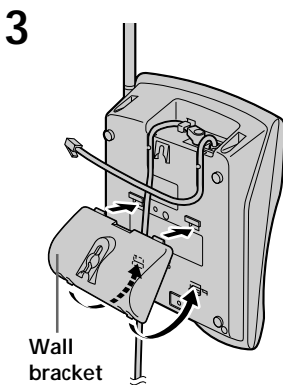
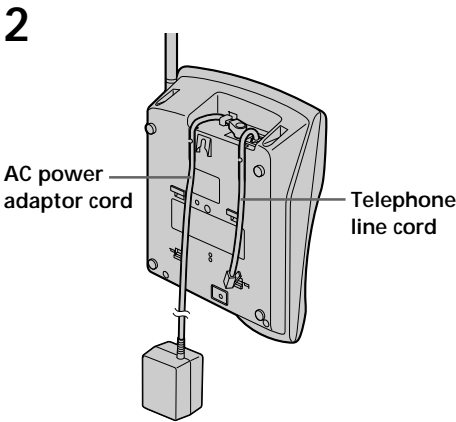
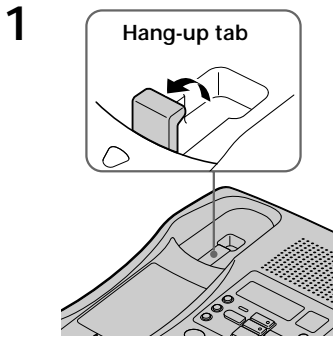

- 1** Raise the hang-up tab.
- 2** Plug the telephone line cord to the LINE jack and the AC power adaptor to the DC IN 9V jack, and hook the cords. Use the shorter cord for mounting.
- 3** Attach the wall bracket to the center of the base phone.  
Align the  $\Delta$  marks of the wall bracket with those of the base phone.
- 4** Plug the telephone line cord to the telephone outlet, and hook the base phone to the wall plate.
- 5** Plug the AC power adaptor to an AC outlet. Then raise the antenna so that it points towards the ceiling.

**Tip**  
To remove the wall bracket, press the lower tabs.

---

# Carrying the handset by the belt clip

You can hang the handset on the belt by attaching the belt clip to the handset.

## Attaching the belt clip

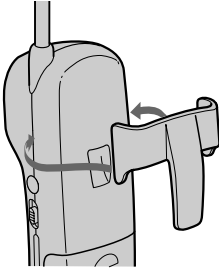

Press the belt clip to the handset. Make sure that the side tabs click and go into the holes on the sides of the handset.

### Note

To prevent the handset from dropping, make sure that each tab is completely inserted.

## Detaching the belt clip

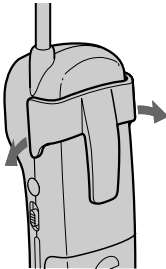

While pressing the back of the belt clip, pull the sides one by one until the tabs come off from the holes.

### Note

Remove the belt clip carefully to avoid breaking your fingernails.

## Using the headset

You can talk on the handset without using your hands by connecting Sony TL-HD1 headset (optional) to the  (HEADSET) jack on the handset.

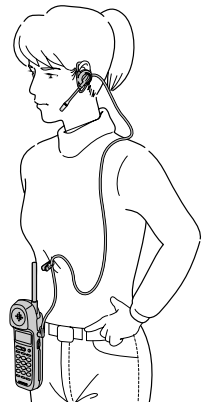

---

# Notes on power sources

## On battery pack

- Store the battery pack at a temperature between 41°F (5°C) and 95°F (35°C) for best performance.
- If you do not use the handset for a long period of time, remove the battery pack from the handset after charging for more than 12 hours, and base phone after charging for more than 24 hours when you have a spare battery. This maintains battery life.

### On power failure

During a power interruption, you **cannot** make or receive calls, and you **cannot** use the answering machine.

## For the customers in the USA

### RECYCLING NICKEL-CADMIUM BATTERIES

Nickel-Cadmium batteries are recyclable. You can help preserve our environment by returning your unwanted batteries to your nearest point for collection, recycling or proper disposal.



Note: In some areas the disposal of nickel-cadmium batteries in household or business trash may be prohibited.

RBRC (Rechargeable Battery Recycling Corporation) advises you about spent battery collection by the following phone number.

Call toll free number: 1-800-822-8837  
(United States and Canada only)

Caution: Do not handle damaged or leaking nickel-cadmium batteries.

---

# Maintenance

- Clean the cabinets with a soft cloth slightly moistened with water or a mild detergent solution. Do not use any type of abrasive pad, scouring powder or solvent such as alcohol or benzine as they may damage the finish of the cabinet.
- If the charge terminals of the base phone and handset are soiled, wipe them with a soft cloth.



If you have any questions or problems concerning your phone, please consult your nearest Sony dealer.

# Troubleshooting

If you've experienced any of the following difficulties while using your phone, use this troubleshooting guide to help you remedy the problem. Should any problem persist, consult your nearest Sony dealer.

	Symptom	Remedy
Making calls	You hear five short error beeps when you press <b>TALK</b> .	<ul style="list-style-type: none"> <li>• Make sure you have set up the base phone correctly (page 10).</li> <li>• Move the handset closer to the base phone.</li> </ul>
	You hear no dial tone.	<ul style="list-style-type: none"> <li>• Make sure the telephone line cord is securely connected to the telephone outlet.</li> <li>• Make sure the battery is fully charged (page 13).</li> </ul>
	The phone does not connect at all, even though the number you dial is correct.	<ul style="list-style-type: none"> <li>• Make sure the dialing mode is set correctly (page 12).</li> </ul>
	The phone does not redial correctly.	<ul style="list-style-type: none"> <li>• Make sure the last dialed number is really the one you want to dial.</li> </ul>
	You hear five short error beeps when you try to redial.	<ul style="list-style-type: none"> <li>• The number you last dialed exceeds 32 digits (including the tone and pause digits if used).</li> <li>• The number you last dialed is erased.</li> </ul>
	You cannot perform the redial operations (redialing, checking and erasing the phone number), and "CHANNEL SEARCHING" appears on the display.	<ul style="list-style-type: none"> <li>• Move the handset closer to the base phone and perform the redial operations again.</li> </ul>
Receiving calls	You cannot hear anything from the speakerphone.	<ul style="list-style-type: none"> <li>• Press <b>VOL</b> <b>+</b> on the base phone to increase the speaker volume.</li> </ul>
	The handset does not ring.	<ul style="list-style-type: none"> <li>• Make sure the ringer is turned on (page 40).</li> <li>• The battery may be weak. Charge the battery for more than 12 hours (page 13).</li> <li>• Make sure you have set up the base phone correctly (page 10).</li> <li>• Move the handset closer to the base phone.</li> </ul>
	The base phone does not ring.	<ul style="list-style-type: none"> <li>• Set the RINGER LEVEL switch on the base phone to HIGH or LOW.</li> <li>• Make sure the telephone line cord is securely connected to the telephone outlet.</li> </ul>



	Symptom	Remedy
During conversation	You hear interference during conversation.	<ul style="list-style-type: none"> <li>• Move the handset closer to the base phone.</li> <li>• Place the base phone away from noise sources (page 10).</li> </ul>
	Your conversation is muted and “CHANNEL SEARCHING” appear on the display.	<ul style="list-style-type: none"> <li>• This is the out-of-range alarm. Move the handset closer to the base phone within one minute.</li> </ul>
	You hear a beep every three seconds and  and “BATTERY LOW” appears on the display.	<ul style="list-style-type: none"> <li>• The battery is weak. Charge the battery for more than 12 hours (page 13).</li> </ul>
Speed dialing/ Phone Directory	You hear five short error beeps and cannot store a number on a speed dialing key or in the Phone Directory.	<ul style="list-style-type: none"> <li>• Make sure you follow the procedure for storing the number correctly (pages 32, 35).</li> <li>• Make sure the number (including the tone and pause digits) does not exceed 32 digits.</li> </ul>
	You hear five short error beeps when you try to make a speed dial call.	<ul style="list-style-type: none"> <li>• You have entered a speed dialing key for which no phone number has been stored.</li> </ul>
	Speed dialing or Phone Directory dialing is incorrect.	<ul style="list-style-type: none"> <li>• Store the correct number (pages 32, 35).</li> </ul>
Intercom	The handset does not ring when you use the intercom from the base phone, and the base phone does not ring when you use the intercom from the handset.	<ul style="list-style-type: none"> <li>• The battery may be weak. Charge the battery for more than 12 hours (page 13).</li> <li>• Move the handset closer to the base phone.</li> <li>• Place the base phone away from noise sources (page 10).</li> </ul>
	When pressing  , you hear a busy tone and cannot make an intercom call.	<ul style="list-style-type: none"> <li>• Either the base phone or handset is being used to converse with an outside caller.</li> </ul>

## Troubleshooting (continued)

	Symptom	Remedy
Answering machine	Message is not recorded.	<ul style="list-style-type: none"> <li>The remaining recording time is less than 30 seconds or 99 messages were recorded. The answering machine becomes "Memory full" status and does not record messages. Erase messages (page 54).</li> <li>The message is less than two seconds. The answering machine does not record messages less than two seconds in length.</li> </ul>
	No sound from the speaker of the base phone.	<ul style="list-style-type: none"> <li>Adjust the speaker volume (page 54).</li> </ul>
	The caller's message is interrupted.	<ul style="list-style-type: none"> <li>The caller's message is too long.</li> <li>The caller's voice is too low. The unit disconnects the line when it detects seven seconds of silence.</li> </ul>
	The clock is incorrect.	<ul style="list-style-type: none"> <li>There was a power interruption. Reset the time (page 46).</li> </ul>
Operating from an outside phone	The phone does not accept your remote ID code (security code).	<ul style="list-style-type: none"> <li>Make sure you call from a touch-tone phone.</li> <li>Make sure the remote ID code (security code) is correct.</li> <li>Make sure you entered the remote ID code (security code) within two seconds after you've entered (#).</li> </ul>
	The line is disconnected when you call your phone from a touch-tone phone.	<ul style="list-style-type: none"> <li>You entered wrong remote ID codes (security codes) three times.</li> </ul>

	Symptom	Remedy
Caller ID	The caller's name and/or phone number does not appear on the display.	<ul style="list-style-type: none"> <li>• Make sure you have subscribed to Caller ID service.</li> <li>• Caller ID service may not work when the phone is connected to a Private Branch Exchange (PBX).</li> <li>• The call is made through company which does not offer Caller ID service. "OUT OF AREA" will appear on the display.</li> <li>• The call was "blocked". "PRIVATE" will appear on the display.</li> <li>• You have answered the call while "** RINGING **" was displayed. Be sure to answer after the Caller ID data is displayed.</li> </ul>
	The caller's name and/or phone number does not appear on the display during call waiting.	<ul style="list-style-type: none"> <li>• Make sure you have subscribed to "Caller ID with call waiting" service (page 68).</li> <li>• Make sure nobody is talking with another phone on the same telephone line.</li> </ul>
	You cannot dial the number from the Caller ID list.	<ul style="list-style-type: none"> <li>• Make sure you entered your home area code correctly (page 16).</li> <li>• You may need to change the number of digits of the phone number (page 66).</li> <li>• This function may not work when the phone is connected to a Private Branch Exchange (PBX).</li> </ul>
	The memory match function does not work.	<ul style="list-style-type: none"> <li>• If the call is from an office which uses multiple lines, the phone number may not match the number you put in the memory.</li> <li>• If you have stored the phone number with an outside line access digit on a speed dialing key or in the Phone Directory because the phone is connected to a Private Branch Exchange (PBX), the phone number will not match the Caller ID data.</li> </ul>
Power source/battery	The CHARGE lamp does not light up when you place the handset to charge.	<ul style="list-style-type: none"> <li>• Wipe the charge terminals of the base phone and the handset with a soft cloth for better contact of the charge terminals.</li> <li>• Make sure the handset is placed on the base phone properly.</li> </ul>
	The battery duration is short.	<ul style="list-style-type: none"> <li>• The battery pack was charged less than 12 hours (due to power failure, etc.).</li> <li>• The usage life of the battery has expired and needs replacement.</li> </ul>
	The CHARGE lamp flashes.	<ul style="list-style-type: none"> <li>• Move the handset closer to the base phone.</li> <li>• Make sure the battery is inserted in the handset.</li> <li>• The battery may be completely discharged. Charge the battery for more than 12 hours (page 13). It may require several times of charging to recover to its full capacity.</li> </ul>

---

## Troubleshooting (continued)

### Message counter

The message counter on the base phone shows the following information.

When the counter shows	It means
Flashing number	Number of messages not yet played back.
CL	Flashes when the day and time is cleared or delayed due to a power interruption, or when you connect the base phone to the AC outlet for the first time. Reset the time correctly (page 46).
A	The announcement only mode is selected (page 55).
F	The recording area is full. Erase unnecessary messages (page 54).

---

# Specifications

## General

- Frequency band  
902 - 928 MHz
- Operating channel  
30 channels
- Dial signal  
Tone, 10 PPS (pulse) selectable
- Supplied accessories  
See page 9.

## Handset

- Power source  
Rechargeable battery pack BP-T23
- Battery charging time  
Approx. 12 hours
- Battery life  
Standby: Approx. 7 days  
Talk: Approx. 7 hours
- Dimensions  
Approx. 2 <sup>3</sup>/<sub>8</sub> x 7 x 1 <sup>13</sup>/<sub>16</sub> inches (w/h/d),  
antenna excluded  
(approx. 58 x 177 x 46 mm)  
Antenna: Approx. 2 <sup>7</sup>/<sub>8</sub> inches  
(approx. 72 mm)
- Mass  
Approx. 9.5 oz  
(approx. 270 g), battery included

## Base phone

- Power source  
DC 9V from AC power adaptor  
AC-T131
- Battery charging time  
Approx. 24 hours
- Dimensions  
Approx. 7 <sup>3</sup>/<sub>8</sub> x 2 <sup>3</sup>/<sub>4</sub> x 9 <sup>1</sup>/<sub>8</sub> inches (w/h/d),  
antenna excluded  
(approx. 186 x 68 x 229 mm)  
Antenna: Approx. 4 <sup>3</sup>/<sub>4</sub> inches  
(approx. 120 mm)
- Mass  
Approx. 1 lb 8 oz  
(approx. 664 g), wall bracket excluded

## Answering machine

- Maximum recording time  
About 15 minutes, using incorporated IC
- Greeting message  
Up to 90 seconds per each
- Incoming and Memo message  
Up to 4 minutes per message

Design and specifications are subject to change without notice.

# Index

## A

- Adjusting volume
  - handset volume 25, 30
  - speaker volume 26, 31, 54
- Announcement only mode 55
- Answering machine
  - playing back messages 53
  - setting up 46
  - turning on 56
- Area code 16
- Audible message alert 50

## B

- Battery pack
  - charging 13
  - duration 14

## C

- Call waiting service 25, 26, 68
- Caller ID 60
  - Caller ID list 61
  - calling back 64
  - memory match function 60
  - storing in Phone Directory 65
- Caller ID with call waiting 68
- Carrying the handset by the belt clip 70
- Connection 11
- Control codes for remote operations 59

## D

- Day and time stamp 46, 53
- Dialing mode
  - choosing 12
  - switching to the tone temporarily 25, 26
- Directory
  - Phone Directory 35

## E, F

- Erasing
  - Caller ID data 62
  - last phone number dialed 28
  - local area code 19
  - messages 54
  - Phone Directory 38

## G

- Greeting 47

## H

- Headset 24, 29, 70
- Hold 25, 26
- Home area code 16

## I, J, K

- Identifying the parts 20
- Intercom 42

## L

- Local area code 18
- Location, base phone 10

## M

- Mailbox 51, 53
- Making calls 24
- Memo 57

- Memory match function 60
- Messages
  - pick up from an outside phone 59
  - playing 53
- Mounting the base phone on a wall 69
- Muting 25, 30

## N

- Number of rings 49

## O

- Operating from an outside phone 58
- OUT OF AREA 60

## P, Q

- Package contents 9
- Phone Directory 35
- Playing back 53
- PRIVATE 60
- Pulse dialing 12

## R

- Receiving calls 29
- Recording
  - greeting 47
  - memo 57
- Redialing 28
- Remote ID code (security code) 58
- Ringer
  - RINGER LEVEL switch 31
  - setting the ringer type 40
  - turning on/off 40

## S

- Screening calls 56
  - turning on/off the screening calls function 56
- Setting up
  - base phone 10
  - handset 13
- Spare battery 15
- Speakerphone 26, 27
- Speed dialing 32
- Stamping messages with day and time 46, 53
- Storing Caller ID data in Phone Directory 65
- Switching phones during a call 41

## T, U

- Toll saver 49
- Talking between the phones 42
- Tone dialing
  - dialing mode 12
  - switching to 25, 26
- Transferring a call 44
- Troubleshooting 72

## V, W, X, Y, Z

- Volume
  - handset 25, 30
  - speaker 26, 31, 54

For the customers in the USA

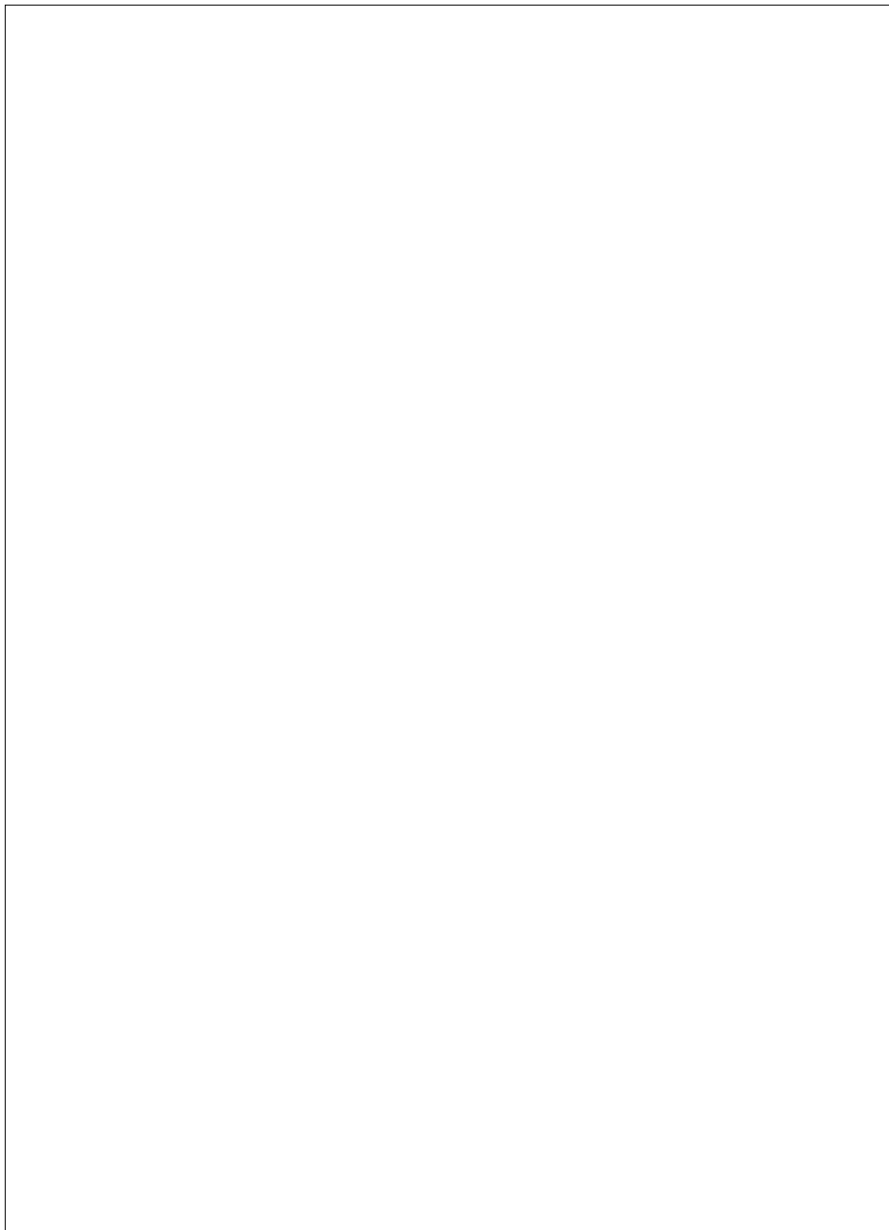

Be sure to save the receipt and attach it to your WARRANTY card when having your equipment repaired at an authorized Sony service center.

For online product registration, please contact  
**[www.sony.com/productregistration](http://www.sony.com/productregistration)**