

thera|pure®
thera|pure

thera|pure®
thera|pure



3000

3000



OWNER'S GUIDE



THANK YOU

Congratulations on purchasing the Therapure® 300D air purifier and your commitment to surrounding yourself and your loved ones with pure, clean air.

Here is an air purifier so advanced, it's changing the future of air purification.

Air purifiers today need to do more than clean the air, they need to kill germs, viruses and bacteria, and remove impurities such as dust, dander, toxic fumes and chemicals. In an ideal world, you could get all this air purification in one machine.

Welcome to an ideal world. With the Therapure® 300D air purifier, we've combined HEPA-Type filtration to purify the air, UV light – the standard in germicidal protection – to kill airborne germs and viruses, and a photocatalyst filter to remove fumes and chemicals.

Get ready to experience cleaner, healthier air!

Visit www.therapureair.com today to find out about the full Therapure® line of products.

PLEASE NOTE: It is crucial that you read and follow all the instructions and safety warnings in this manual for optimal performance of your air purifier and your health and safety.

TABLE OF CONTENTS

SAFETY INSTRUCTIONS	2
IMPORTANT WARNINGS	3
About UV Light Technology	3
UV Lamp Notice	3
Mercury Notice	3
UV Lamp Disposal Notice	3
PRODUCT BENEFITS	4
KNOWING YOUR THERAPURE® 300D	5
Main Parts	5
HOW TO ASSEMBLE AND USE	7
OPERATING YOUR THERAPURE® 300D	8
Control Panel	8
Digital Display	9
CLEANING AND MAINTENANCE	10
Cleaning the Therapure® 300D	10
Replacing the UV Lamp	11
TO ORDER A REPLACEMENT UV LAMP	11
TROUBLE-SHOOTING	12
ORDERING MORE AMAZING THERAPURE® PRODUCTS	13
ONE-YEAR LIMITED WARRANTY	14
CUSTOMER SERVICE CONTACT INFORMATION	14
ARBITRATION AGREEMENT	15

SAFETY INSTRUCTIONS

WARNING: RISK OF ELECTRICAL SHOCK

Safety precautions should always be used when operating this or any electrical appliance. Decrease the risk of electrocution, electric shock, injury or fire by reading and following all the warnings below.

Use only as described in this Therapure® 300D air purifier manual. To reduce the risk of electric shock, do not attempt to service the product in any way other than in the manner described in the “Cleaning & Maintenance” section of this manual.

- ⦿ Read all instructions before operating the Therapure® 300D air purifier.
- ⦿ This product operates at 120V AC, 60Hz only.
- ⦿ Do not run power cord under carpets, and do not cover with throw rugs.
- ⦿ Do not operate the product in any greasy environment such as in the kitchen. This product is not intended to filter oil or grease from air.
- ⦿ Do not use the Therapure® 300D air purifier in bathrooms or other humid environments, near fireplaces or in areas where flammable or combustible vapors or products may exist.
- ⦿ Always unplug the power cord from electrical socket when the purifier is not in use, before cleaning, inserting or removing parts or before moving to another location.
- ⦿ Never run the air purifier unless it is fully assembled.
- ⦿ To reduce the risk of electric shock, this product has a polarized plug (one blade is wider than the other). This plug will fit into a polarized outlet only one way. If the plug does not fit into the outlet, contact qualified service personnel to install the proper outlet. Do not alter the plug in any way.
- ⦿ Always turn off all controls before unplugging the Therapure® 300D air purifier from outlet.
- ⦿ Attempting to service the Therapure® 300D air purifier in any way that is not described in this owner’s manual will cause the warranty to be voided and could cause serious personal injury to the user and/or result in considerable damage to the unit.
- ⦿ Do not place the cord near a heated surface.
- ⦿ Never operate the Therapure® 300D air purifier if the plug or cord is damaged or appears damaged. Only qualified service personnel should ever replace or attempt to replace a damaged power cord.
- ⦿ Never use the power cord to pick up, carry, drag, pull, or lift the Therapure® 300D air purifier. Do not pull the cord against or around sharp corners and edges. This could result in injury to the user or damage to the cord.
- ⦿ Always remove the plug from its power outlet by holding onto the plug itself and pulling gently.
- ⦿ Never pull on the cord itself to unplug it from its power outlet.
- ⦿ Use care when operating the Therapure® 300D air purifier by keeping all foreign objects, fingers, body parts, hair, loose clothing and jewelry away from openings.
- ⦿ Never touch the Therapure® 300D air purifier or its plug when your hands are wet.
- ⦿ The Therapure® 300D air purifier is an electrical appliance. Adult supervision is required when operating the Therapure® 300D in the presence of children.

IMPORTANT WARNINGS

ABOUT UV LIGHT TECHNOLOGY

Therapure® uses the UV light to effectively kill bacteria and viruses. Hospitals have utilized UV light for years to eliminate dangerous airborne diseases, cold and flu viruses, bacteria, strep and staph and illness-causing mold spores.

The same kind of scientifically-proven UV light technology hospitals use to ensure the cleanest, most sanitary environments for patients and staff is now available in our Therapure® 300D air purifier.

UV Lamp Notice Warning

UV light is harmful to bare skin and eyes and can cause temporary or permanent loss of vision. Never look directly at the UV lamp while it is illuminated-doing so could cause loss of vision! To prevent exposure to ultraviolet light, disconnect the power to the unit before servicing any part of the Therapure® 300D air purifier.

Be sure to follow all safety warnings described in your owner’s manual. Use UV light technology and enjoy healthier air as directed.

Mercury Notice

This device contains mercury in the sealed ultraviolet lamp(s). Do not place your used lamp(s) in the trash. Disposal of any item containing mercury must be in accordance with any hazardous waste disposal or recycling laws and regulations of your state.

UV Lamp Disposal Notice

If the UV lamp breaks, turn off the unit. Do not operate the unit with a broken lamp. Do not use a vacuum to clean up breakage. Sweep debris into a plastic bag and dispose of properly. Contact your local waste management authority for instructions regarding recycling and the proper disposal of old lamp(s). To order a replacement lamp, call **1.800.875.8577** or go to **www.therapureair.com**.

PRODUCT BENEFITS

The revolutionary Therapure® 300D air purifier is the only air purifier with a permanent HEPA-type filter, a built-in UV germicidal lamp, and a CADR* of 180.

The Therapure® 300D air purifier boasts:

Triple action purification:

- ⊙ Permanent HEPA-type filter removes particles from the air.
 - ⊙ UV germicidal lamp kills airborne bacteria, germs, viruses and more.
 - ⊙ Photocatalyst filter removes VOCs (volatile organic compounds), including toxic fumes and chemicals such as paint and new carpet fumes.
- ⊙ Effectively removes smoke, pollen, dust, animal dander, dust mites, mold and bacteria.
 - ⊙ Powerful and quiet fan has 4 fan speed settings to select desired cleaning level.
 - ⊙ High clean air efficiency with 180 CADR* at high setting.
 - ⊙ A twelve hour timer to set the time of operation, from 1 hour up to 12 hours.
 - ⊙ Built-in ionizer revitalizes air.
 - ⊙ Auto power shut-down protection when back cover is removed-provides extra safety.
 - ⊙ Low power consumption-energy efficient.

*Clean Air Delivery Rate as defined by ANSI standards. CADR measures the amount of particle-free air being delivered into the room. Therapure® 300D air purifier boasts a CADR of 180—an outstanding performance for an air purifier.



KNOW YOUR THERAPURE® 300D

MAIN PARTS

1. Permanent HEPA-type filter: Removes airborne particles as small as 0.1 microns in size.
2. 4-Speed Settings: there are 4 speed settings: quiet, low, medium and high for you to choose from.
3. 12 hour timer: Set a cleaning cycle from 1-12 hours—according to the air purification needs in the room.
4. Control Panel.
5. Built-in ionizer: revitalizes air by releasing negative ions in just the right concentration to keep air fresh.
6. Digital display: indicates setting and whether the unit is on or off.
7. Photocatalyst filter –removes VOCs (volatile organic compounds), including toxic fumes and chemicals such as paint and new carpet fumes.
8. UV Lamp: the UV germicidal light kills germs, viruses & bacteria.

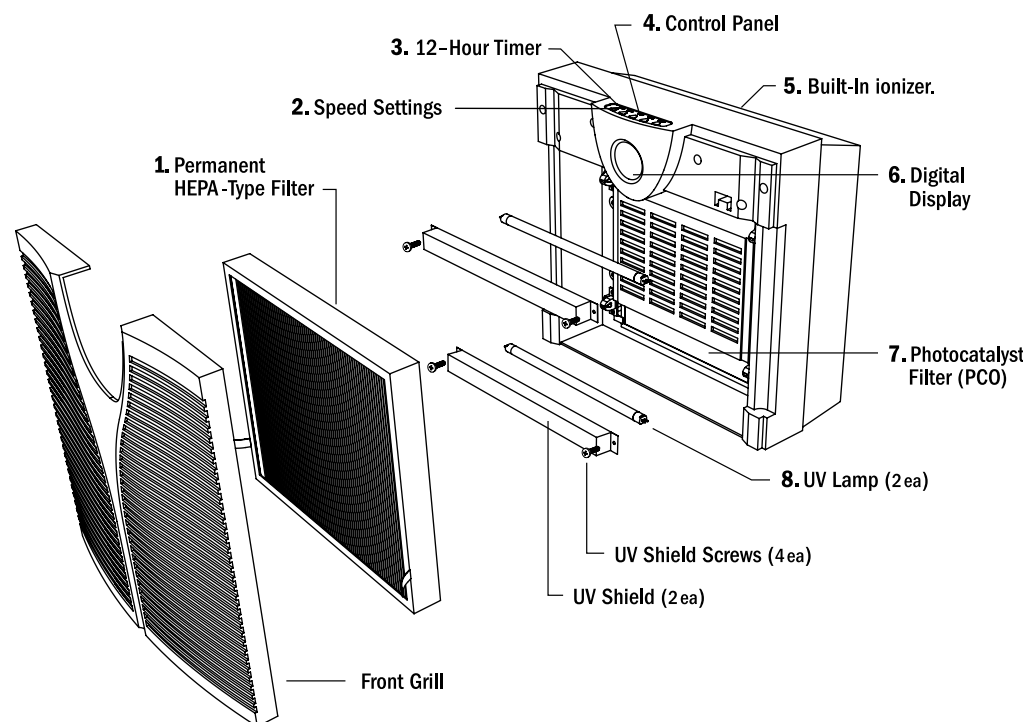

HOW TO ASSEMBLE AND USE

Please note: make sure the permanent HEPA-type filter is properly installed before use.

1. Keep both sides of the unit more than 4 inches away from a wall.
2. Do not blow air from a fan or air conditioner directly into the air purifier.
3. Do not place the unit where the air inlet or outlet grill could come in contact with a curtain.
4. Placing the unit close to the source of air pollution can improve indoor air quality effectively.

1.

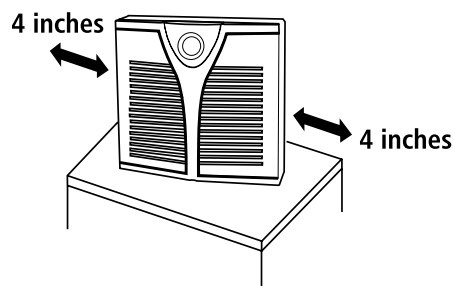

2.

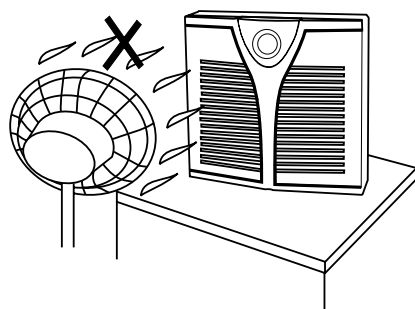

3.

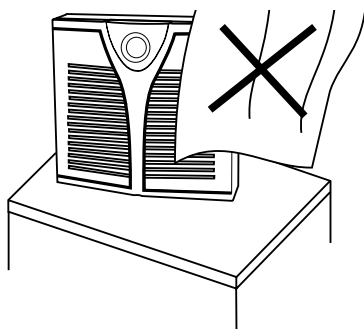

4.

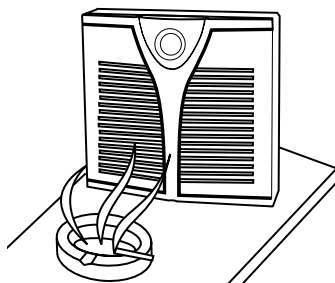

OPERATING YOUR THERAPURE® 3000

Plug the unit into an electrical outlet. The unit will be ready to run. Read the following directions to select desired settings.

CONTROL PANEL

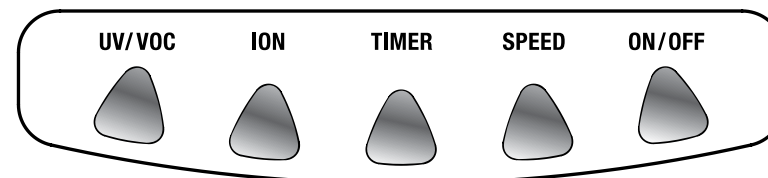

1. Press the **ON/OFF** button to turn on your air purifier and press it again to turn it off.
2. When the air purifier is turned on, the fan will run at low speed (this is the default speed). Press the **SPEED** button to cycle through the fan speeds shown below:

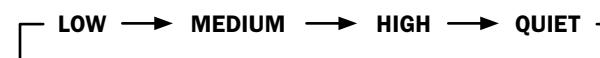

3. While the fan is running, press the **TIMER** button to select the desired run time (in hours) as shown below:

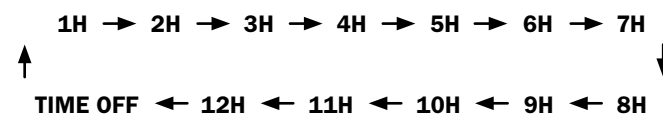

4. Press the **ION** button to turn on the ionizer while the fan is running and press it again to turn off the ionizer.
5. Press the **UV/VOC** button to turn on the germicidal light and filter. Press it again to turn off.

OPERATING YOUR THERAPURE® 300D

DIGITAL DISPLAY

1. Fan Speed Indicator

The first bar is lit when the fan speed is on **QUIET**. The first two bars are lit when the fan speed is **LOW**. The first three bars are lit when the fan speed is **MEDIUM**. When all four bars are lit, the fan speed is **HIGH**.

Therapure's powerful, yet quiet, 4-speed fan let's you determine your desired sanitizing level. Simply select your desired setting and the fan draws in the contaminated air in front of your Therapure® 300D air purifier and starts sanitizing.

The 4 speeds are Quiet, Low, Medium or High. The speed you set determines how rapidly you want to sanitize the air. The "**LOW**" setting is great for day in, day out use. The "**MEDIUM**" setting is great for areas with more airborne contaminants (such as excessive smoke, pet dander, etc), or areas used frequently by allergy-sufferers. The "**HIGH**" setting is best used for shorter bursts of time when you want to rapidly sanitize the air. "**QUIET**" is for the most silent low speed operation.

2. Timer Indicator

The digit of the timer indicates the hour(s) preset. Once the time is set, the timer will start to count down to zero and the unit will then automatically turn off.

3. ION Indicator

The ion light turns on when the ionizer is working and the light turns off when the ionizer stops.

4. UV/VOC

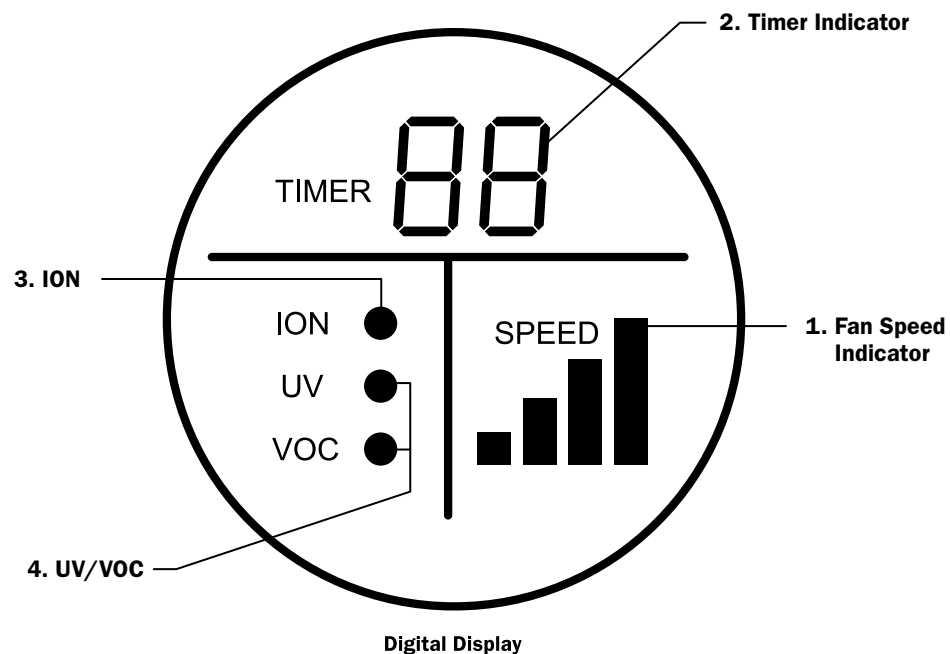

CLEANING & MAINTENANCE

Before cleaning or replacing the permanent HEPA-type filter or UV lamp of your Therapure® 300D air purifier, turn off and unplug the unit from the electrical outlet and read all safety instructions and important warnings in this owner's manual.

CLEANING THE THERAPURE® 300D

Cleaning the Permanent HEPA-Type Filter

1. Make sure unit is turned off and unplugged. With the front of the unit facing up, pull up the lower end of the inlet grill as shown below.
2. After pulling up, push the inlet grill toward the display panel at the top of the unit.
3. Remove the permanent filter by lifting and pulling the string.
4. Clean the filter after every 200-300 hours of use, or more often if unit is used more frequently or if air quality is poor. The filter can be cleaned with a vacuum. After cleaning and re-inserting the filter, put inlet grill back on the front of the unit or clean inlet grill as described below and then put it back in its original position before resuming use.
5. Clean the inlet grill after every 200-300 hours of use, or you can clean it more frequently if unit is placed in an area with a high level of airborne irritants. The inlet grill can be cleaned with a vacuum or a piece of damp cloth. When finished cleaning, insert the top of the inlet grill first and then snap the lower part of the inlet grill back into position.

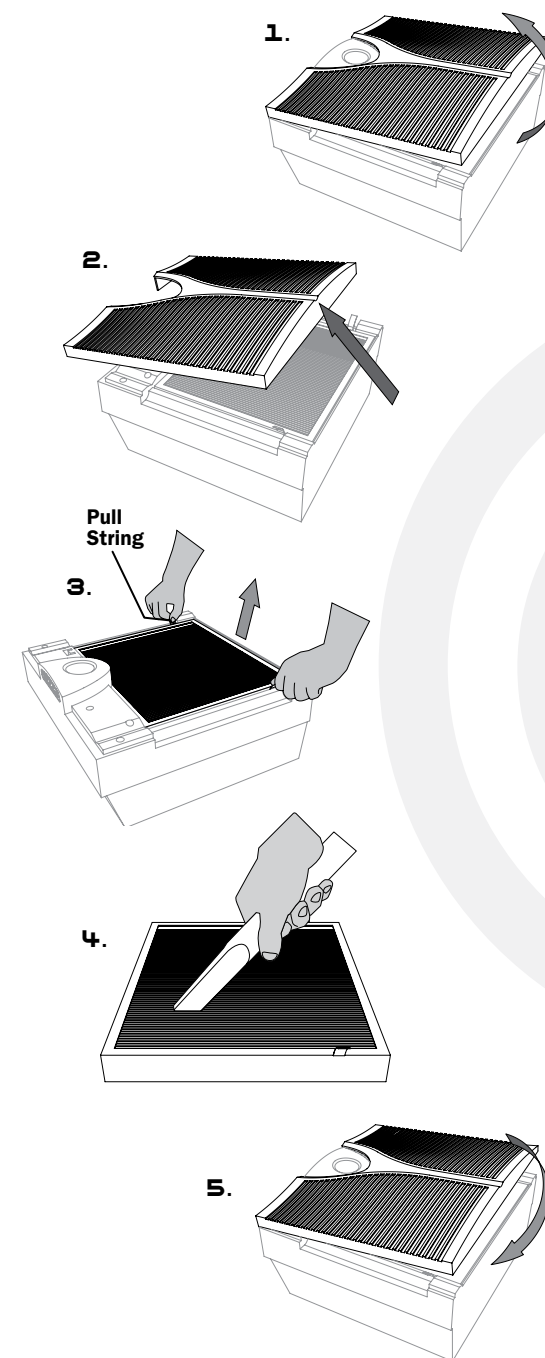

CLEANING & MAINTENANCE

REPLACING THE UV LAMP

UV LAMP SAFETY WARNING:

To prevent exposure to ultraviolet light, disconnect power to the unit before servicing any part of the Therapure® 300D air purifier.

Before replacing the UV lamp of your Therapure® 300D air purifier, turn off and unplug the unit from the electrical outlet and read all safety instructions and important warnings in this owner's manual.

Replace your UV lamp every year. Call **800.875.8577** or visit **www.therapureair.com**.

1. First turn off and unplug your Therapure® 300D air purifier. With the front of the unit facing up, pull up the lower end of the inlet grill and push it toward the display panel at the top of the unit as shown below.

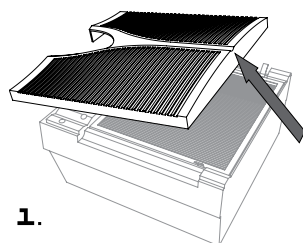

1.

2. Remove the permanent filter by lifting and pulling the string.

3. Remove the screws on the UV shield by using a screwdriver. Allow the UV lamp to cool at least 15 minutes.

4. Remove UV shield.

5. Gently rotate the lamp a quarter turn in either direction until it unlocks from the socket. The lamp removes and installs in the same way as a fluorescent light lamp. Pull out the lamp.

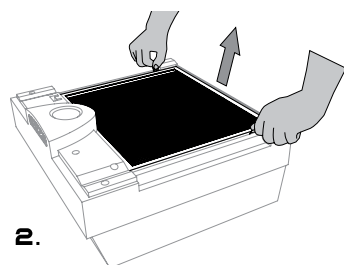

2.

6. Unpack the new UV lamp gently by handling the ends only. Starting at one end of the lamp, then the other, gently insert the metal pins on the lamp into the white slotted socket, one pin at a time. Once the ends of the lamp are completely inserted into the socket, rotate the lamp a quarter turn until it locks into place.

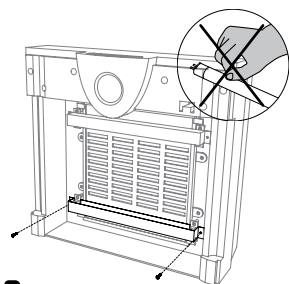

3.

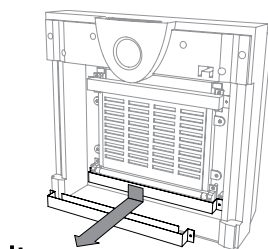

4.

7. Reinstall the UV shield according to the following illustration.

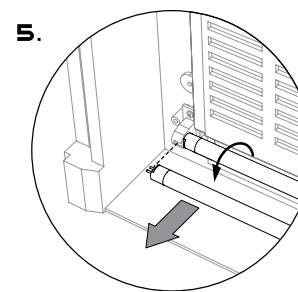

5.

8. First, insert the bottom of the filter into the air cleaner and then insert the top of the filter.

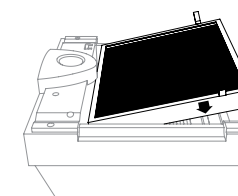

8.

9. Insert the top of the inlet grill first and then snap in the lower part of the grill.

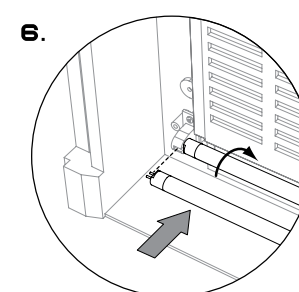

6.

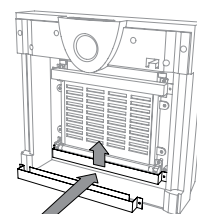

7.

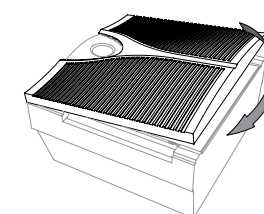

9.

Caution:

- ⊙ Do not touch the glass part of the lamp. Oil from fingertips will decrease the effectiveness of the lamp.
- ⊙ Never operate the unit without a filter or with a damaged filter. The UV light from the UV lamp will result in severe damage to eyes and could cause blindness.

UV Lamp Notice Warning

UV Light is harmful to bare skin and eyes and can cause temporary or permanent loss of vision. Never look directly at the UV lamp while it is illuminated-doing so could cause loss of vision!

TO ORDER A REPLACEMENT UV LAMP

If your UV Lamp(s) is broken or needs replacing, simply contact us at **1.800.875.8577** or visit us online at **www.therapureair.com**.

Therapure® replacement lamp part number is TPG63000.

TROUBLESHOOTING

Before contacting our customer service department, please try the following solutions:

PROBLEM	REASON	SOLUTION
Unit won't operate.	<ol style="list-style-type: none"> 1. ON/OFF button hasn't been pressed. 2. Unit is unplugged. 3. The inlet grill has not been installed or put back in place properly. 	<ol style="list-style-type: none"> 1. Press ON/OFF button. 2. Plug in unit. 3. Check to ensure filters are properly installed & the inlet grill is installed & locked into place. (See instructions on pg. 9).
Reduced air flow or poor filtering.	<ol style="list-style-type: none"> 1. The inlet or outlet grill may be blocked. 2. The permanent HEPA-type filter may be clogged. 	<ol style="list-style-type: none"> 1. Ensure nothing is in front of or on top of the purifier. 2. Check filter and clean it if necessary (See instructions on pg. 9).

TO ORDER MORE THERAPURE® PRODUCTS

Our Therapure® line of products addresses a growing concern we all have regarding airborne germs. Therapure® air purifiers effectively kill bacteria and viruses with the same kind of scientifically-proven UV technology hospitals use. Therapure® air purifiers delivers pure, clean air.

To find out more about our full line of air purifiers, visit us today at www.therapureair.com.



thera|pure®

ONE-YEAR LIMITED WARRANTY

ONE YEAR LIMITED WARRANTY

Your Therapure® 300D air purifier is warranted to be free from defects in materials and workmanship for one year from the original purchase date, excluding the lamp. Should the product have a defect in materials or workmanship, we will repair or replace it without charge to you (a shipping and processing fee may apply). To obtain service under warranty, simply call our customer service center toll-free at **800-554-6168**.

This warranty does not cover damage caused by accident, misuse or any use other than as intended and described in this product manual, or damage resulting from failure to maintain and clean this product as specified in this product manual. This warranty applies only to the original purchaser of the Therapure® 300D air purifier.



CONTACT INFO FOR WARRANTY SERVICE:

Therapure

P.O. Box 4135 | Hollywood, CA | 90028
800.554.6168 | www.therapureair.com

© 2006-2008 Therapure, LLC. All Rights Reserved.

ARBITRATION AGREEMENT

THIS ARBITRATION AGREEMENT AFFECTS YOUR LEGAL RIGHTS AND REMEDIES BY PROVIDING THAT DISPUTES BETWEEN YOU AND THE SELLER OF THIS PRODUCT MUST BE RESOLVED THROUGH BINDING ARBITRATION, RATHER THAN IN A COURT. PLEASE READ THIS AGREEMENT CAREFULLY. YOU WILL ACCEPT THE TERMS OF THIS AGREEMENT BY RETAINING THE PRODUCT(S) SHIPPED IN CONNECTION WITH THIS AGREEMENT (THE "PRODUCT") FOR MORE THAN FOURTEEN (14) DAYS AFTER RECEIPT. IF YOU DO NOT AGREE TO THE TERMS OF THIS AGREEMENT, YOU MAY RETURN THE PRODUCT WITHIN FOURTEEN (14) DAYS OF RECEIPT AT NO COST TO YOU.

1. RESOLUTION OF CLAIMS OR DISPUTES. Any claim or dispute between you and the seller of this product (subsidiaries or affiliates) ("collectively, the seller of this product") arising out of or relating in any way to the Product or this Agreement shall be resolved through final, binding arbitration. This arbitration obligation applies regardless of whether the claim or dispute involves a tort, fraud, misrepresentation, product liability, negligence, violation of a statute, or any other legal theory. Both you and the seller of this product specifically acknowledge and agree that you waive your right to bring a lawsuit based on such claims or disputes and to have such lawsuit resolved by a judge or jury.

2. LIMITATION OF LEGAL REMEDIES. All arbitrations under this Agreement shall be conducted on an individual (and not a class-wide) basis, and an arbitrator shall have no authority to award class-wide relief. You acknowledge and agree that this Agreement specifically prohibits you from commencing arbitration proceedings as a representative of others or joining in any arbitration proceedings brought by any other person.

3. ARBITRATION PROCEDURES.

a. Before commencing any arbitration proceedings under this Agreement, you must first present the claim or dispute to the seller of this product by calling 818.217.2500 and asking for the Legal Department and allowing the seller of this product the opportunity to resolve the claim or dispute. If your claim or dispute is not resolved within sixty (60) days, you may commence arbitration proceedings in accordance with the terms of this Agreement.

b. The arbitration of any claim or dispute under this Agreement shall be conducted pursuant to the American Arbitration Association's ("AAA") United States Commercial Dispute Resolution Procedures and Supplementary Procedures for Consumer-Related Disputes. These rules and procedures are available by calling the AAA or by visiting its web site at www.adr.org.

c. The arbitration of any claim or dispute under this Agreement shall be conducted in the State of California or the location in which you received this Agreement.

d. All administrative expenses of arbitration proceedings commenced under this Agreement shall be divided equally between you and the seller of this product, except that: (a) if the claim or dispute that is the subject of the arbitration proceedings is less than ten thousand dollars (US\$10,000), you will be responsible for no more than one hundred twenty-five dollars (US\$125) in administrative expenses; (b) if the claim or dispute that is the subject of the arbitration proceedings is more than ten thousand dollars (US\$10,000) but less than seventy-five thousand dollars (US\$75,000), you will be responsible for no more than three hundred seventy-five dollars (US\$375) in administrative expenses; and (c) if the claim or dispute that is the subject of the arbitration proceedings is more than seventy-five thousand dollars (US\$75,000), then you will be responsible for administrative expenses in accordance with the Commercial Fee Schedule provided by the AAA. You acknowledge and agree that each party shall pay the fees and costs of its own counsel, experts and witnesses.

4. CHOICE OF LAW. This Agreement shall be governed by the United States Federal Arbitration Act and the laws of the state of California.

5. SEVERABILITY. If any provision of this Agreement is declared or found to be unlawful, unenforceable or void, such provision will be ineffective only to the extent that it is found unlawful, unenforceable or void, and the remainder of the provision and all other provisions shall remain fully enforceable.

