

Use and Care Guide



TO THE INSTALLER: PLEASE LEAVE THIS INSTRUCTION BOOK WITH THE UNIT.
TO THE CONSUMER: PLEASE READ AND KEEP THIS BOOK FOR FUTURE REFERENCE.

KitchenAid®
FOR THE WAY IT'S MADE.®

A Note to You.....	2
Important Safety Instructions.....	3
Parts and Features.....	7
Cookware.....	10
Electric Cooktop with Cast-Iron Surface Units	
Use.....	11
Care.....	13
Electric Ceramic Cooktop with Radiant/Halogen Surface Units	
Use.....	16
Care.....	18
Gas Cooktop with Sealed Burners	
Use.....	20
Care.....	22
Electric Grill	
Use.....	27
Care.....	29
Side Mount Downdraft Vent System	
Use.....	31
Care.....	32
Troubleshooting.....	34
Requesting Assistance or Service.....	35
Warranty.....	36

1-800-422-1230

Call with questions or comments.

KITCHENAID® Create-A-Cooktop

Models: KECT025 KECC027 KGCT025
KECG020 KSVD060B

A Note to You

Thank you for buying a KITCHENAID® appliance!

KitchenAid designs the best tools for the most important room in your house. To ensure that you enjoy many years of trouble-free operation, we developed this Use and Care Guide.

It contains valuable information concerning how to operate and maintain your new appliance properly and safely. Please read it carefully. Also, please complete and mail the enclosed Product Registration Card.

Please record your model's information.

Whenever you call our Consumer Assistance Center at **1-800-422-1230** or request service for your appliance, you need to know your complete model number and serial number. You can find this information on the model and serial number plate (see illustration on page 7 for location of plate).

Please also record the purchase information.

Model Number _____

Serial Number _____

Purchase/
Installation Date _____

Builder/Dealer
Name _____

Address _____

Phone _____

NOTE: You must provide proof of purchase or installation date for in-warranty service.

Keep this book and the sales slip together in a safe place for future reference.

WARNING: If the information in this manual is not followed exactly, a fire or explosion may result causing property damage, personal injury or death.

– **Do not store or use gasoline or other flammable vapors and liquids in the vicinity of this or any other appliance.**

– **WHAT TO DO IF YOU SMELL GAS:**

- **Do not try to light any appliance.**
- **Do not touch any electrical switch; do not use any phone in your building.**
- **Immediately call your gas supplier from a neighbor's phone. Follow the gas supplier's instructions.**
- **If you cannot reach your gas supplier, call the fire department.**

– **Installation and service must be performed by a qualified installer, service agency or the gas supplier.**

Important Safety Instructions

Your safety and the safety of others is very important.

We have provided many important safety messages in this manual and on your appliance. Always read and obey all safety messages.



This is the safety alert symbol.

This symbol alerts you to hazards that can kill or hurt you and others.

All safety messages will be preceded by the safety alert symbol and the word “DANGER” or “WARNING.” These words mean:

⚠ DANGER

You will be killed or seriously injured if you don't follow instructions.

⚠ WARNING

You can be killed or seriously injured if you don't follow instructions.

All safety messages will identify the hazard, tell you how to reduce the chance of injury, and tell you what can happen if the instructions are not followed.

IMPORTANT SAFETY INSTRUCTIONS

WARNING – To reduce the risk of fire, electrical shock, injury to persons, or damage when using the cooktop, follow basic precautions, including the following:

- **CAUTION** – Do not store items of interest to children in cabinets above the cooktop – children climbing on the cooktop to reach items could be seriously injured.
- Proper Installation – The cooktop, when installed, must be electrically grounded in accordance with local codes or, in the absence of local codes, with the *National Electrical Code, ANSI/NFPA 70*. Be sure the cooktop is properly installed and grounded by a qualified technician.
- This cooktop is equipped with a three-prong grounding plug for your protection against shock hazard and should be plugged directly into a properly grounded receptacle. Do not cut or remove the grounding prong from this plug.

- Disconnect the electrical supply before servicing the cooktop.
- Never Use the Cooktop for Warming or Heating the Room.

Injuries may result from the misuse of the cooktop such as stepping, leaning, or sitting on the top surface.

- Maintenance – Keep cooktop area clear and free from combustible materials, gasoline, and other flammable vapors and liquids.
- Storage on Cooktop – Flammable materials should not be stored on or near surface units.
- Top burner flame size should be adjusted so it does not extend beyond the edge of the cooking utensil.

– SAVE THESE INSTRUCTIONS –



Important Safety Instructions

IMPORTANT SAFETY INSTRUCTIONS

- **DO NOT TOUCH SURFACE UNITS OR AREAS NEAR UNITS** – Surface units may be hot even though they are dark in color. Areas near surface units may become hot enough to cause burns. During and after use, do not touch, or let clothing or other flammable materials contact surface units or areas near units until they have had sufficient time to cool. Among those areas are the cooktop and surfaces facing the cooktop.
- **Use Proper Pan Size** – This cooktop is equipped with one or more surface units of different size. Select utensils having flat bottoms large enough to cover the surface unit heating element. The use of undersized utensils will expose a portion of the heating element to direct contact and may result in ignition of clothing. Proper relationship of utensil to burner will also improve efficiency.
- **Never Leave Surface Units Unattended at High Heat Settings** – Boilover causes smoking and greasy spillovers that may ignite.
- **Glazed Cooking Utensils** – Only certain types of glass, glass/ceramic, ceramic, earthenware, or other glazed utensils are suitable for cooktop service without breaking due to the sudden change in temperature.
- **Utensil Handles Should Be Turned Inward and Not Extend Over Adjacent Surface Units** – To reduce the risk of burns, ignition of flammable materials, and spillage due to unintentional contact with the utensil, the handle of a utensil should be positioned so that it is turned inward, and does not extend over adjacent surface units.
- **Do Not Cook on Broken Cooktop** – If cooktop should break, cleaning solutions and spillovers may penetrate the broken cooktop and create a risk of electric shock. Contact a qualified technician immediately.
- **Clean Cooktop With Caution** – If a wet sponge or cloth is used to wipe spills on a hot cooking area, be careful to avoid steam burn. Some cleaners can produce noxious fumes if applied to a hot surface.

For units with ventilating hood –

- **Clean Ventilating Hoods Frequently** – Grease should not be allowed to accumulate on hood or filter.
- **When flaming foods under the hood, turn the fan off.** The fan, if operating, may spread the flame.

– SAVE THESE INSTRUCTIONS –



IMPORTANT SAFETY INSTRUCTIONS

Vent system

- Do not block the vent system.
- Do not put hands in vent box when fan is on. Injury could result.
- Filter must be in place for proper vent system operation.

Care and cleaning

- Clean cooktop with care. Some cleaners can produce noxious fumes if applied to a hot surface. If a wet paper towel is used to wipe spills on a hot cooking area, be careful to avoid steam burns.
- Do not repair or replace any part of the cooktop unless specifically recommended in this manual. All other servicing should be referred to a qualified technician.
- Any additions, changes, or conversions required in order for this appliance to satisfactorily meet the application needs must be made by an authorized dealer.

- Disconnect the electrical supply and/or gas supply at the shutoff valve near the cooktop before servicing the cooktop.

Gas cooktop

- Gas fuels and their use in appliances can cause minor exposures to benzene, formaldehyde, carbon monoxide, and soot, primarily from incomplete combustion. Significant exposure to these substances can be a health risk. Properly adjusted burners with a blue, rather than a yellow, flame will minimize incomplete combustion. Venting with a hood or an open window will further minimize exposure.
- Never use a match or other flame to look for a gas leak. Explosion and injury could result.
- Know where your main gas shutoff valve is located.

– SAVE THESE INSTRUCTIONS –

continued on next page



IMPORTANT SAFETY INSTRUCTIONS

WARNING: To reduce the risk of fire, electric shock, or injury to persons, observe the following:

- Use this unit only in the manner intended by the manufacturer. If you have questions, contact the manufacturer.
- Before servicing or cleaning unit, switch power off at service panel and lock the service disconnecting means to prevent power from being switched on accidentally. When the service disconnecting means cannot be locked, securely fasten a warning device such as a tag, to the service panel.

WARNING: To reduce the risk of a range top grease fire:

- Keep fan, filters and grease laden surfaces clean.
- Always turn hood ON when cooking at high heat.
- Use high range setting on range only when necessary. Heat oil slowly on low to medium setting.
- Don't leave range unattended when cooking.
- Always use cookware and utensils appropriate for the type of food being prepared.

WARNING: To reduce the risk of injury to persons in the event of a range top grease fire, observe the following:

- SMOTHER FLAMES with a close-fitting lid, cookie sheet, or metal tray, then turn off the burner. BE CAREFUL TO PREVENT BURNS. If the flames do not go out immediately, EVACUATE and CALL THE FIRE DEPARTMENT.
- NEVER PICK UP A FLAMING PAN – You may be burned.
- DO NOT USE WATER, including wet dishcloths or towels – a violent steam explosion will result.
- Use an extinguisher ONLY if:
 1. You know you have a Class ABC extinguisher and you already know how to operate it.
 2. The fire is small and contained in the area where it started.
 3. The fire department is being called.
 4. You can fight the fire with your back to an exit.

Caution: For General Venting Use Only. Do Not Use To Exhaust Hazardous Or Explosive Materials and Vapors.

– SAVE THESE INSTRUCTIONS –

Parts and Features

Welcome to the world of customized cooktop cooking!

With your Create-A-Cooktop, you can combine several cooktops into one. Depending on which capabilities you want your cooktop to have, your unit can include one or more of any of the following components: Electric Cooktop with Cast-Iron Surface Units, Electric Ceramic Cooktop with Radiant/Halogen Surface Units, Gas Cooktop with Sealed Burners, Electric Grill, and Side

Mount Downdraft Vent System. (For information on installing your Create-A-Cooktop, see the Installation Instructions included with your unit.)

This section contains captioned illustrations of each component available to you. Use them to become familiar with the location and appearance of all parts and features.



Electric cooktop with cast-iron surface units (Model KECT025)

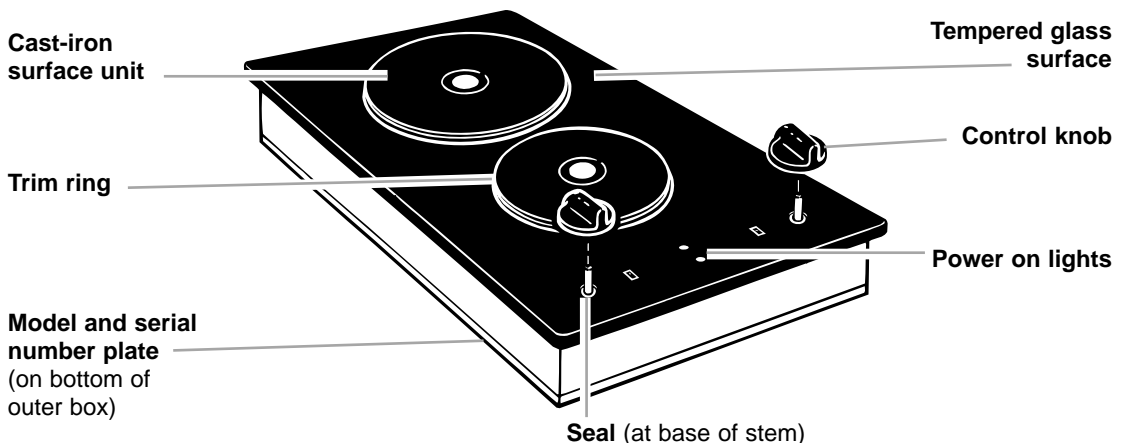



Parts and Features

Electric ceramic cooktop with radiant/halogen surface units (Model KECC027)

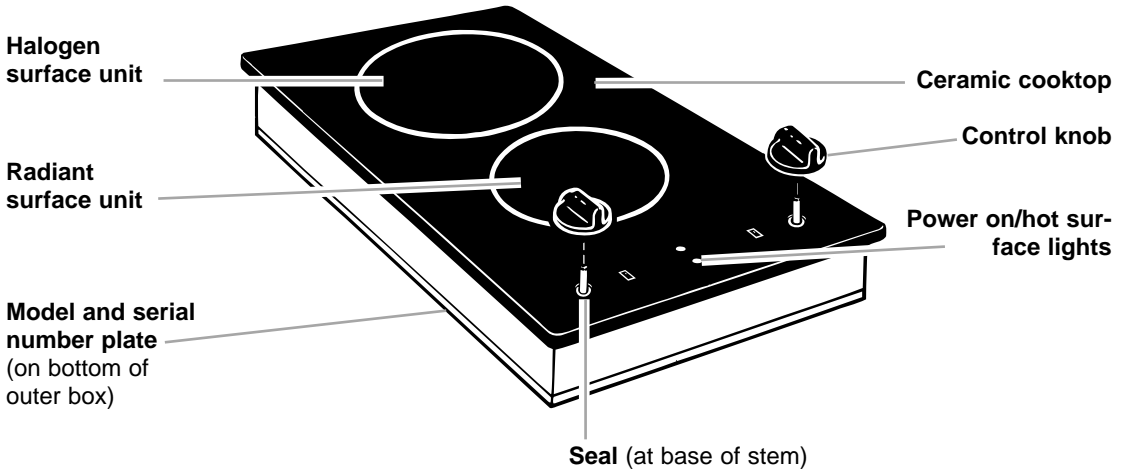

Gas cooktop with sealed burners (Model KGCT025)

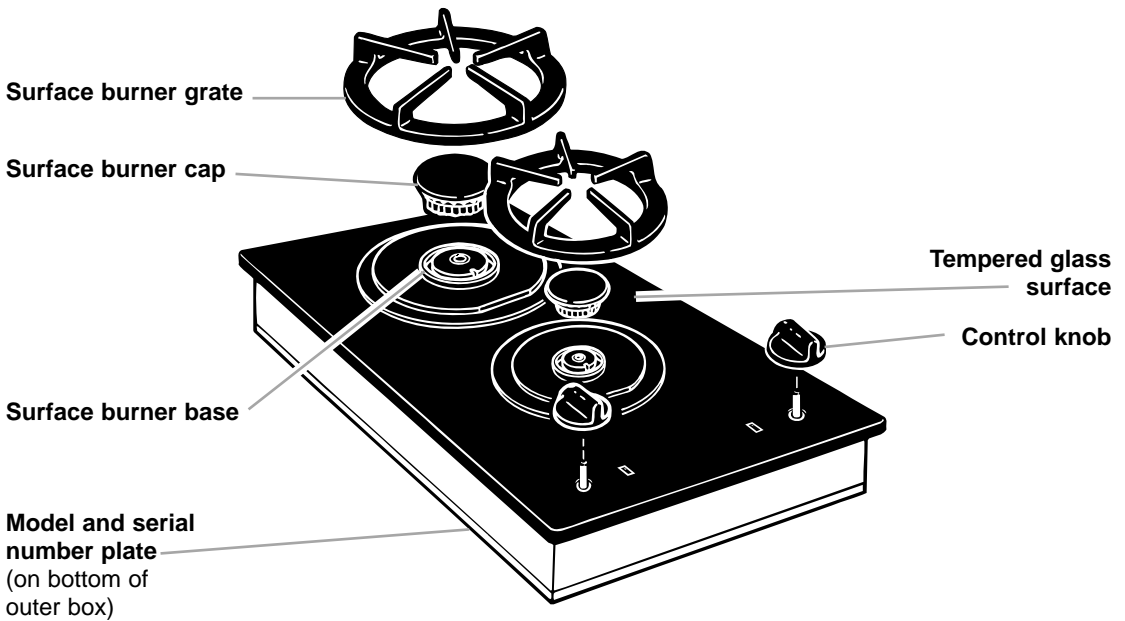



Electric grill (Model KECG020)

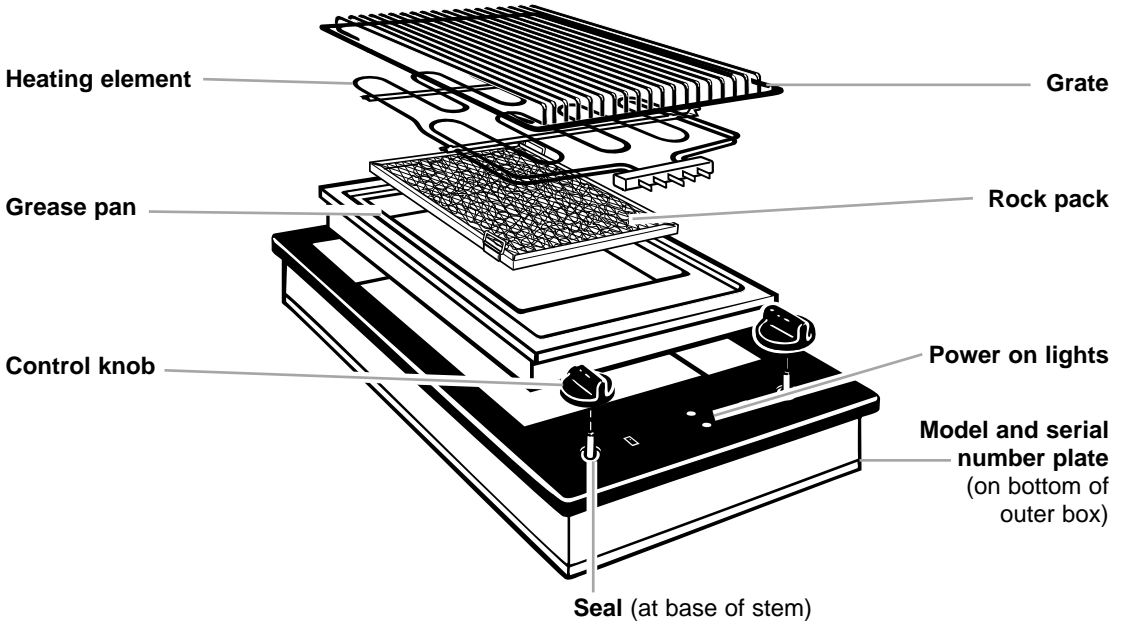

Side mount downdraft vent system (Model KSVD060B)

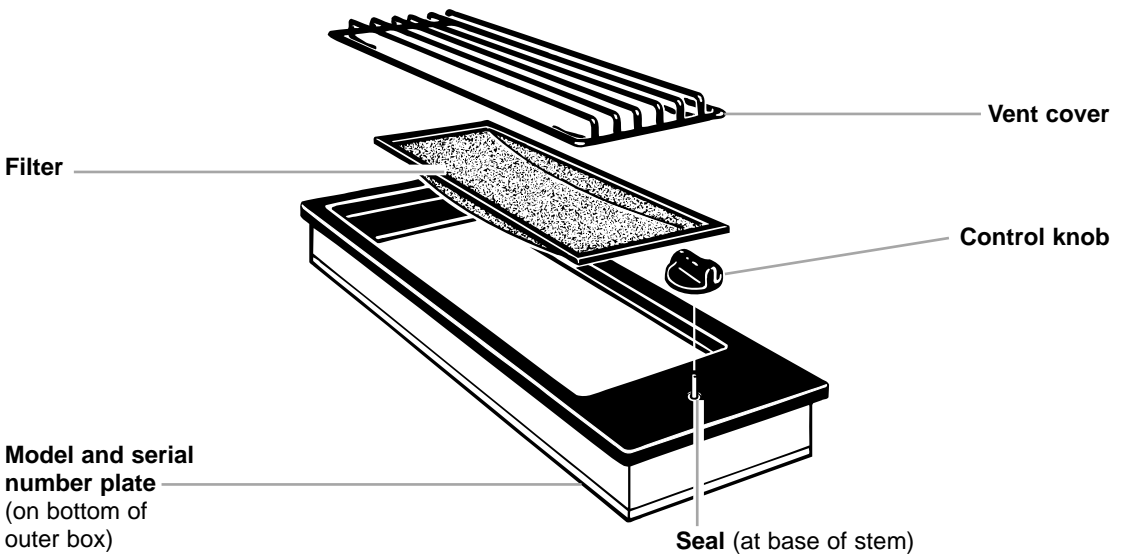

Cookware

Cookware tips

- **Select a pan** that is about the same size as the surface cooking area. Cookware should not extend more than 1 inch (2.5 cm) outside the area.
- **For best results and greater energy efficiency**, use only flat-bottomed cookware that makes good contact with the surface cooking area. Cookware with rounded, warped, ribbed (such as some porcelain enamelware), or dented bottoms could cause uneven heating and poor cooking results.
- **Cookware designed** with slightly indented bottoms or small expansion channels can be used.
- **Cookware with non-stick finish** has heating characteristics of the base material.
- **Check for rough spots** on the bottom of metal or glass cookware which will scratch the ceramic glass surface.
- **Use flat bottom cookware** for best heat conduction from the surface cooking area to the cookware. Determine flatness with the ruler test. Place the edge of a ruler across the bottom of the cookware. Hold it up to the light. No light should be visible under the ruler. Rotate the ruler in all directions and look for any light.
- **Do not leave** empty cookware, or cookware that has boiled dry, on a hot surface cooking area. The cookware could overheat, causing damage to the cookware or the surface cooking area.

Characteristics of cookware materials

The pan material affects how fast heat transfers from the surface cooking area through the pan material and how evenly heat spreads over the pan bottom. Choose pans that provide the best cooking results.

Aluminum	<ul style="list-style-type: none">• Heats quickly and evenly.• Use for all types of cooking.• Medium or heavy thickness is best for most cooking.• Used as a core or base in cookware to provide even heating.
Cast iron	<ul style="list-style-type: none">• Heats slowly and evenly.• Good for browning and frying.• Maintains heat for slow cooking.• Can be coated with porcelain enamel.
Ceramic or ceramic glass	<ul style="list-style-type: none">• Heats slowly and unevenly.• Use on low to medium settings.• Follow manufacturer's instructions.
Copper	<ul style="list-style-type: none">• Heats very quickly and evenly.• Used as a core or base in cookware to provide even heating.
Earthenware	<ul style="list-style-type: none">• Can be used for cooktop cooking if recommended by the manufacturer.• Use on low settings.
Porcelain enamel-on-steel or enamel-on-cast iron	<ul style="list-style-type: none">• See cast iron and stainless steel.
Stainless steel	<ul style="list-style-type: none">• Heats quickly but unevenly.• A core or base of aluminum or copper on the cookware provides even heating.• Can be coated with porcelain enamel.

Electric Cooktop with Cast-Iron Surface Units

Use

In This Section	Page	Page	
Power on lights	11	Control setting guide	12
Surface unit markers	11	The cast-iron surface units	12

Cast-iron surface units may retain heat for a longer period of time than standard surface units. To get the most out of this cooktop, please read the following instructions.

Power on lights

The Power On Lights on the control panel glow when a surface unit is turned on. The top light works with the rear surface unit, while the bottom light works with the front surface unit.

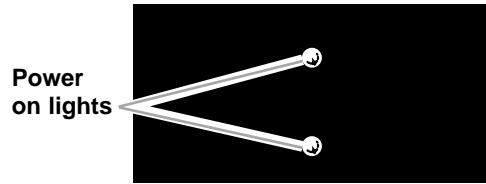

Surface unit markers

The solid dot in the surface unit marker shows which surface unit is turned on by that knob.

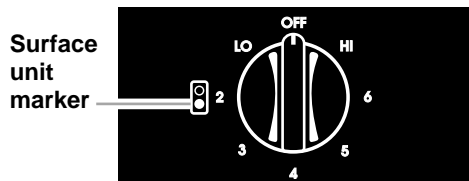



Using Your Electric Cast-Iron Surface Unit Cooktop

Control setting guide

⚠ WARNING



Fire Hazard

Turn off all controls when done cooking.

Failure to do so can result in death or fire.

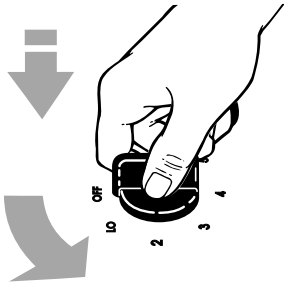

Push in controls before turning to a setting. You can set them anywhere between HI and OFF.

Until you get used to the settings, use the chart below as a guide. For best results, start cooking at the high setting; then turn the control knob down to continue cooking.

SETTING	RECOMMENDED USE
HI	<ul style="list-style-type: none"> • To start food cooking. • To bring liquid to a boil.
6-5	<ul style="list-style-type: none"> • To hold a rapid boil. • To quickly brown or sear meat.
4	<ul style="list-style-type: none"> • To make pudding, sauce, or gravy. • To maintain a slow boil. • To fry poultry or meat.
3-2	<ul style="list-style-type: none"> • To stew or stem food. • To simmer food.
LO	<ul style="list-style-type: none"> • To maintain liquid just below simmer. • To melt chocolate or butter. • To keep food warm.

The cast-iron surface units

Cast-iron surface units are made of heavy cast-iron to provide even cooking. Each surface unit has a built-in protective limiter as a safety feature.

The limiter senses uneven cooking temperatures when:

- **A pan boils dry.**
- **A pan is removed** and the surface unit is left on.
- **The bottom of the pan** is too large or too small for the surface unit. This will result in longer cooking times.
- **The bottom of the pan** is rounded, warped, ribbed, or dented and does not make full contact with the surface unit.

The limiter will automatically reduce the heat level to provide even cooking temperatures and to protect the surface unit.

NOTE: Cast-iron surface units stay hot for a long time. Do not use the HI setting for long periods of time or leave pans on hot surface units when cooking is done. Burned food and damage to the cookware could result. You may want to turn the cast-iron surface unit off a few minutes before you finish cooking.

Before placing a pan on cast-iron surface units for the first time, heat on HI setting for five minutes. The surface units will give off smoke as the protective coating, applied at the factory, finishes bonding to the surface.



Care

In This Section	Page	Page	
Control knobs	13	The cast-iron surface units	14
Tempered glass surface	13	Cleaning chart	15

Your cooktop is designed for easy care. You can do most cleaning with items found around your home. Clean your cooktop whenever spills or soiling occurs to help keep it looking and operating like new.

NOTE: Let cooktop cool before cleaning.

Control knobs

1. **Make sure** all control knobs are turned to OFF.
2. **Pull** the control knobs straight off.
3. **Wash** control knobs with sponge and warm, soapy water. **Rinse** well and **dry** with a soft cloth. Do not soak.
4. **Replace** control knobs by pushing them firmly into place.

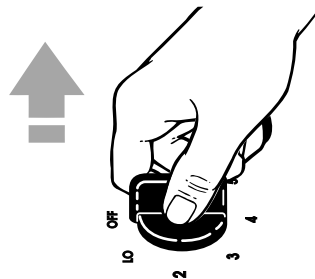

NOTES:

- **When cleaning**, never use steel wool, abrasives, or commercial oven cleaners which may damage the finish. After cleaning, make sure all control knobs point to OFF.
- **To prevent** moisture from collecting in control area, do not remove seals under control knobs. Wipe up spills in control area as soon as they occur.

Tempered glass surface

1. **Wipe** with sponge and warm, soapy water or paper towel and mild glass cleaner.
2. **Dry** with a soft cloth.
3. If soap or detergent solutions are used, **make sure** to rinse thoroughly to prevent filmy residue.



NOTE: When cleaning cooktop with knobs removed, DO NOT allow water to run down inside unit. When cleaning, never use steel wool, abrasives, or commercial oven cleaners which may damage the finish.



Caring for Your Electric Cast-Iron Surface Unit Cooktop

The cast-iron surface units

- 1. For best results, wipe off** surface units with a damp sponge and soapy water after each use. **Remove** burned-on food with a nonabrasive, soap-filled scouring pad. The red spot in the center of the surface unit will gradually wash off. This is normal and will not affect the operation of the surface unit.
- 2. Dry** the surface unit completely after cleaning. **Turn on** the surface unit for a few minutes to thoroughly dry.
- 3. After the surface unit has cooled, use** a paper towel to apply a thin coat of salt-free oil to the surface units to season and restore the finish. **Wipe** excess oil off trim rings.
- 4. Then heat** 3-5 minutes. Some smoking may occur; this is normal. If surface units have dark spots caused by grease and food, the oil treatment will improve their appearance but not eliminate the spots.

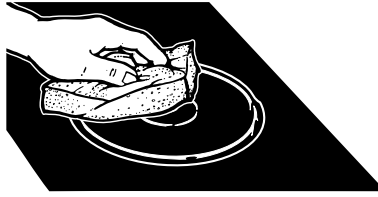

NOTE: You can apply optional Electrol dressing to the surface units to improve their appearance.

To obtain order information for Electrol dressing (Part No. 814030), write to:

KitchenAid
Parts Distribution Center
123 Koomler Drive
LaPorte, IN 46350

OR

Call **1-800-422-1230** to order. You must have a major credit card to order by phone.



Cleaning chart

Use this chart for proper and effective cleaning of your cast-iron surface unit cooktop.

PART	WHAT TO USE	HOW TO CLEAN
Control knobs	Warm, soapy water and a sponge	<ul style="list-style-type: none"> • Wash, rinse, and dry well. • Do not soak. • Do not remove seals under control knobs.
Tempered glass surface	Sponge and warm, soapy water or paper towel and spray glass cleaner	<ul style="list-style-type: none"> • Wipe off regularly when cooktop is cool. • If soap or detergent solutions are used, wipe with clean water thoroughly to prevent filmy residue. • Dry with a soft cloth.
Cast-iron surface units	<p>Warm, soapy water and a sponge</p> <p>Soapy, nonabrasive scrubbing pad or scouring powder</p> <p>Salt-free oil on a paper towel</p> <p>Electrol dressing</p>	<ul style="list-style-type: none"> • Clean when cooktop and surface units are cool. • Wipe off the surface units after each use. • NOTE: After each cleaning, heat surface units until dry. • To darken surface units or to remove rust spots: • Make sure surface units are cool. • After each cleaning, apply thin coat of oil to surface units, then heat for 3-5 minutes. Slight smoking of oil will occur. • Follow the directions on the dressing. • NOTE: Oil and dressing will improve surface unit appearance, but will not eliminate dark spots caused by grease and food.
Trim rings (with oxide coating)	<p>Sponge and warm, soapy water or paper towel and spray glass cleaner</p> <p>Soapy, nonabrasive scrubbing pad</p> <p>DO NOT use a soapy steel-wool pad</p>	<ul style="list-style-type: none"> • Clean when cooktop and surface units are cool.

Electric Ceramic Cooktop with Radiant/Halogen Surface Units

Use

In This Section		Page	Page
Power on/hot surface lights.....	16	Control setting guide	17
Surface unit markers	16	The ceramic cooktop	17

The ceramic cooktop features a smooth, streamlined surface for ease of cooking and cleaning. However, because ceramic cooktops operate differently than standard coil surface unit cooktops, you should review this section carefully for proper use.



! WARNING

Fire Hazard

Turn off all controls when done cooking.

Failure to do so can result in death or fire.

Power on/hot surface lights

One of the Power On/Hot Surface Lights on the control panel glows when a surface unit is turned on or is hot. The top light works with the rear surface unit, while the bottom light works with the front surface unit.

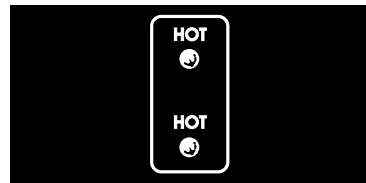

Surface unit markers

The solid dot in the surface unit marker shows which surface unit is turned on by that knob.

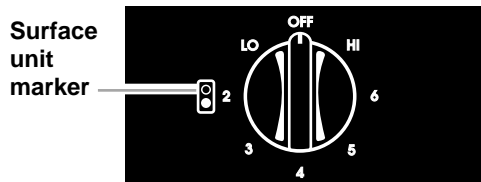



Control setting guide

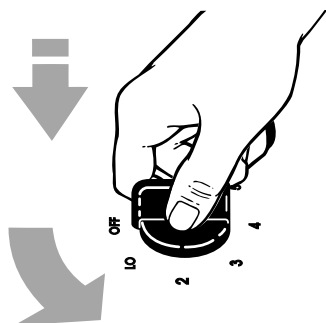

Push in controls before turning to a setting. You can set them anywhere between HI and OFF.

Until you get used to the settings, use the chart at right as a guide. For best results, start cooking at the high setting; then turn the control knob down to continue cooking.

SETTING	RECOMMENDED USE
HI	<ul style="list-style-type: none"> • To start food cooking. • To bring liquid to a boil. • Turn to LO or 3-2 when sizzle starts.
6-5	<ul style="list-style-type: none"> • To hold a rapid boil. • To fry poultry or meat. • Turn to LO or 3-2 when sizzle starts.
4	<ul style="list-style-type: none"> • To make pudding, sauce, or gravy. • To cook large amounts of vegetables. • Turn to LO to finish cooking.
3-2	<ul style="list-style-type: none"> • To keep food cooking after starting it on a higher setting.
LO	<ul style="list-style-type: none"> • To keep food warm.

The ceramic cooktop

The rear surface unit features a halogen element. This element lights up as soon as you turn it on and is brighter than regular coil elements.

Cooking on the ceramic glass cooktop is similar to cooking on coil elements. There are, however, a few differences:

- **The surface cooking area** will glow red when the element is turned on. You will see the element cycling on and off – even on the HI setting – to help the area stay at the temperature setting you chose.
- **Do not cook foods** directly on the cooktop.
- **Do not cook popcorn** that comes in prepackaged aluminum containers on the cooktop. The container could leave aluminum marks on the cooktop that cannot be removed completely.
- **Make sure the bottoms** of pots and pans are clean and dry before using them. Food and water particles left on the bottoms can leave deposits on the cooktop when it is heated.
- **Lift pots and pans** onto and off of the cooktop. Sliding pots and pans on the cooktop could leave marks that are difficult to remove or could leave permanent marks.
- **Dropping a heavy or hard object** on the cooktop could crack it. Be careful when using heavy skillets and large pots. Do not store jars or cans above the cooktop.
- **Do not use** the cooktop as a cutting board.
- **Do not allow** anything that could melt, such as plastic, to come in contact with the cooktop while it is hot.
- **Sugary spills and soils** can cause pitting. See “Cleaning the cooktop and control panel” in the “Caring for Your Cooktop” section for more information.
- **Wiping off the cooktop** before and after each use will help keep the surface free from stains and give you the most even heating. See “Cleaning the cooktop and control panel” in the “Caring for Your Cooktop” section for care and cleaning suggestions.



Care

In This Section

	Page	Page
Control knobs	18	Cleaning your cooktop.....19
Ceramic cooktop and control panel	18	

Your cooktop is designed for easy care. You can do most cleaning with items found around your home. Cleaning your cooktop whenever spills or soiling occurs helps to keep it looking and operating like new.

NOTE: Let cooktop cool before cleaning.

Control knobs

1. **Make** sure all control knobs are turned to OFF.
2. **Pull** the control knobs straight off.
3. **Wash** control knobs with sponge and warm, soapy water. **Rinse** well and **dry** with a soft cloth. Do not soak.
4. **Replace** control knobs by pushing them firmly into place.

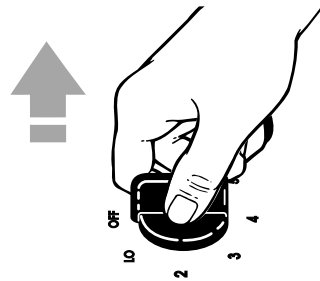

NOTES:

- **When cleaning**, never use steel wool, abrasives, or commercial oven cleaners which may damage the finish. After cleaning, make sure all control knobs point to OFF.
- **To prevent** moisture from collecting in control area, do not remove seals under control knobs. Wipe up spills in control area as soon as they occur.

Ceramic cooktop and control panel

This cooktop is designed for easy care. However, ceramic glass cooktops need to be maintained differently than standard electric coil elements. Foods spilled directly on the cooktop will not burn off as on coil elements. Because of this, the surface should be dust-free and soil-free before heating.

The Cooktop Polishing Creme included with your cooktop, paper towels or a sponge is all you need to clean your cooktop. For proper cleaning methods, please review the "How to keep your cooktop looking like new" chart. Follow this chart after each use to ensure top performance and to preserve that uniquely elegant look.



NOTE: Let cooktop cool before cleaning.



Cleaning your cooktop

Cleaning tips

What to use:

- **Cooktop Polishing Creme** included with your cooktop with a paper towel or clean, damp sponge. This creme has been developed especially for cleaning and polishing your cooktop. When using, follow instructions on container.
- **Razor scraper** – Use to remove cooked-on soils from your ceramic glass cooktop. To avoid scratches, keep the razor blade as flat against the cooktop as possible. **Store razor blades out of reach of children.**
- **Do not use** steel wool, plastic cleaning pads, abrasive powdered cleansers, chlorine bleach, rust remover, ammonia, or glass cleaning products with ammonia. These products could damage the cooktop surface.

Steps to follow:

1. **Most spills** can be wiped off easily using a paper towel or clean, damp sponge as soon as Hot Surface Indicator Light goes off.
2. **For stubborn spills**, rub Cooktop Polishing Creme into cooked-on soil using a paper towel. If some soil remains, leave some creme on the spot(s) and follow Step 3.
3. **Carefully scrape** spots with the razor scraper.
4. **Finish by polishing** entire cooktop with Cooktop Polishing Creme and a paper towel.

To order Cooktop Polishing Creme (Part No. 3184477), call 1-800-422-1230 and follow the instructions and telephone prompts you hear.

NOTE: Always wipe and dry your cooktop thoroughly after using cleanser to prevent streaking or staining.

How to keep your cooktop looking like new:

IF THERE ARE	WHAT TO DO
Sugary spills and soils (such as jellies and candy syrups)	To prevent pitting on the cooktop, wipe up with a paper towel or clean, damp sponge while ceramic glass surface is still warm. Remove as soon as possible after spill occurs.
Burned-on soils	Rub Cooktop Polishing Creme or nonabrasive cleanser into soil using a paper towel. Reapply creme to spots remaining. Hold razor scraper as flat to surface as possible, scrape spots. Polish entire cooktop with creme and paper towel. Rinse and dry. Store razor blades out of reach of children.
Dark streaks, specks, and discoloration	Use Cooktop Polishing Creme or nonabrasive cleanser with a damp paper towel or sponge.
Metal marks (from copper or aluminum pans)	Use Cooktop Polishing Creme or nonabrasive cleanser with a damp paper towel or sponge before heating the cooktop again. If heated before cleaning, metal marks may not come off.
Tiny scratches or abrasions	Scratches and abrasions do not affect cooking. In time, they will become less visible as a result of cleaning. To prevent scratches and abrasions, use Cooktop Polishing Creme regularly.

Gas Cooktop with Sealed Burners

Use

In This Section		Page	Page
Surface burner markers	20	Surface burners	21
Control setting guide	21		

Your gas cooktop with sealed burners provides you with even heat and a clean, modern look. For the most effective cooking, please read the following instructions.

! WARNING



Fire Hazard

Do not let the burner flame extend beyond the edge of the pan.
Turn off all controls when not cooking.
Failure to follow these instructions can result in death or fire.

Surface burner markers

The solid dot in the surface burner marker shows which surface burner is turned on by that knob.

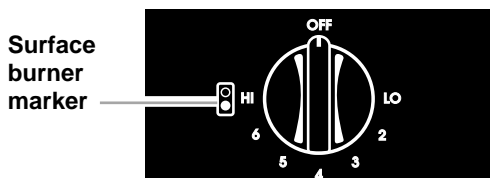



Control setting guide

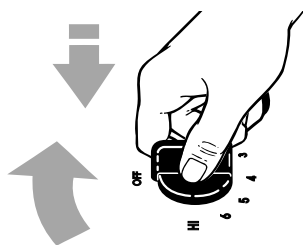

Push in controls before turning to a setting. You can set them anywhere between HI and OFF.

Until you get used to the settings, use the chart at right as a guide. For best results, start cooking at the high setting; then turn the control knob down to continue cooking.

NOTE: Cooking times may need to be adjusted when using a vent system with your gas cooktop.

SETTING	RECOMMENDED USE
HI	<ul style="list-style-type: none"> To start food cooking. To bring liquid to a boil.
6-5	<ul style="list-style-type: none"> To hold a rapid boil. To quickly brown or sear meat.
4	<ul style="list-style-type: none"> To make pudding, sauce, or gravy. To maintain a slow boil. To fry poultry or meat.
3-2	<ul style="list-style-type: none"> To stew or stem food. To simmer food.
LO	<ul style="list-style-type: none"> To maintain liquid just below simmer. To melt chocolate or butter. To keep food warm.

Surface burners

The gas sealed burners have an auto-reignition system. The sealed burners spread heat evenly across the bottom of the cooking utensil and provide infinite heat control. The auto-reignition system senses when a burner flame has gone out and will automatically reignite that burner.

Your cooktop is factory-set for use with Natural Gas. If you wish to use L.P. gas, L.P. Gas Conversion Kits are available from your authorized KitchenAid dealer or parts outlet. Use Kit No. 4175444 for Model KGCT025Y. Use Kit No. 4173627 for Model KGCT025A. In all cases, the conversion must be done by a qualified service technician.

When to use the rear burner:

Use this burner for cooking large quantities of food, deep-fat frying, or cooking with a large cooking utensil.

When to use the front burner:

Use this burner for simmering or for cooking smaller quantities of food requiring a small cooking utensil.

How to use the surface burners:

1. **Grasp** the control knob.
2. **Push down** and **turn** to the left to HI. The electric spark ignitor will ignite the gas flowing into the burner. When you hear a clicking sound, you know that the ignitors are working. Gas is flowing as long as the control knob is not set at OFF.
3. **When the burner is lit, turn** the control knob to the left to the desired flame setting. (See guide above.) The ignitor will turn off and the clicking will stop when the burner ignites.

NOTES:

- **The ignitors** may click a number of times before the burner lights. This is normal.
- **Both burner ignitors** will spark regardless of which burner you are using.
- **Visually check** that burner has lit. If the burner does not ignite, listen for the clicking sound. If you do not hear the ignitor click, **TURN THE BURNER OFF.** Check that the service cord is firmly in



Caring for Your Gas Sealed Burner Cooktop

place in the wall receptacle. Check for a tripped circuit breaker or blown fuse. Check that the control knob is pressed completely down on valve shaft. **If the spark ignitor still fails to operate, call your nearest authorized KitchenAid service company.**

Proper grounding and polarity is necessary for correct operation of the electric ignition system. If the wall receptacle does not provide correct polarity, the ignitor will become grounded and click every once in a while, even after the burner has ignited. A qualified electrician should check the wall receptacle to see if it is wired with correct polarity.

- **Do not use** this gas sealed burner cooktop for canning.

In case of a prolonged power failure

Surface burners can be manually lighted.

1. **Hold** a lighted match near a burner and **turn** the control knob to HI.
2. **After the burner lights, turn** the control knob to the desired setting.

NOTES:

- **Be careful** when lighting burner.
- **Do not leave** cooktop unattended when cooking.

Care

In This Section

	Page		Page
Control knobs	23	Gas sealed burners	24
Tempered glass surface	23	Caring for your cooktop.....	25
		Cleaning chart	26

Your cooktop is designed for easy care. You can do most cleaning with items found around your home. Cleaning your cooktop whenever spills or soiling occurs helps to keep it looking and operating like new.

NOTE: Let cooktop cool before cleaning.



Control knobs

1. **Make sure** all control knobs are turned to OFF.
2. **Pull** the control knobs straight off.
3. **Wash** control knobs with sponge and warm, soapy water. **Rinse** well and **dry** with a soft cloth. Do not soak.
4. **Replace** control knobs by pushing them firmly into place.

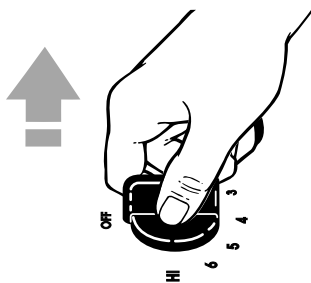

NOTES:

- **When cleaning**, never use steel wool, abrasives, or commercial oven cleaners which may damage the finish. After cleaning, make sure all control knobs point to OFF.
- **To prevent** moisture from collecting in control area, do not remove seals under control knobs. Wipe up spills in control area as soon as they occur. Moisture can cause the ignitor switches to fail.

Tempered glass surface

1. **Wipe** with sponge and warm, soapy water or paper towel and mild glass cleaner.
2. **Dry** with soft cloth.
3. If soap or detergent solutions are used, **rinse** thoroughly to prevent filmy residue.

NOTES:

- **When cleaning** cooktop with knobs removed, DO NOT allow water to run down inside unit. When cleaning, never use steel wool, abrasives, or commercial oven cleaners which may damage the finish.
- **When cleaning** the cooktop or the area around the burner base, remove the grate but leave the burner cap in place to protect the ignitor from possible damage. If a cleaning cloth catches the ignitor, it could damage or break the ignitor. If the ignitor is damaged or broken, the surface burner will not light.



Caring for Your Gas Sealed Burner Cooktop

Gas sealed burners

Surface burner grates

1. **Make sure** all surface burners are off and the surrounding parts are cool.

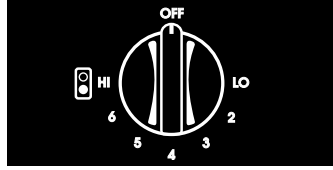

2. **Lift off** the burner grates.

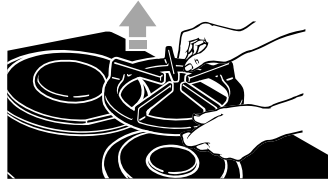

3. **Wash** the grates with warm, soapy water. **Use** a non-abrasive plastic scrubbing pad for heavily soiled areas. **Rinse** and **dry** well. **Do not place grates in a dishwasher.**



4. **Replace** burner grates.

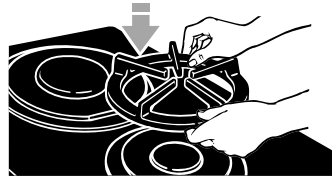



Caring for your cooktop

Your cooktop is designed for easy care. You can do most cleaning with items found around the home. Cleaning your cooktop whenever spills or soiling occurs will help to keep it looking and operating like new.

NOTES:

- **Before cleaning** make sure all controls are off and the cooktop is cool.
- **Do not obstruct** the flow of combustion and ventilation air.
- **If knobs are removed** while cleaning, be careful not to spill liquids through holes in the control area.
- **Be careful** not to allow moisture to collect in control area. Moisture could cause ignitor switches to fail.

Surface burners

- **The burner caps** should be routinely removed and cleaned. Always clean burner caps after a spillover. Keeping the burner caps clean prevents improper ignition and an uneven flame.
- **For proper flow** of gas and ignition of the burner, **DO NOT ALLOW SPILLS, FOOD, CLEANING AGENTS, OR ANY OTHER MATERIAL TO ENTER THE GAS TUBE OPENING.**
- **Occasionally check** the burner flames for proper size and shape as shown later in this section. A good flame is blue in color. If flames lift off ports, are yellow, or are noisy when turned off, you may need to clean the burners.

NOTE: To check oven burner flames for proper size and shape, see the Installation Instructions also included with the range.

To clean burners and burner caps:

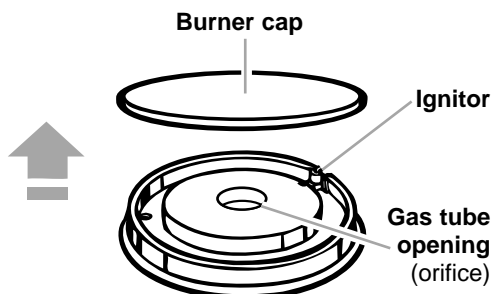

1. **Lift** the burner cap straight up from the burner base.
2. **Clean** burner cap with warm, soapy water and a sponge. For stubborn stains, clean with a mildly abrasive plastic scrubbing pad and powdered cleanser. Do not clean burner cap in dishwasher.
3. **If the gas tube opening** or the orifice, located inside the opening, has become soiled or clogged, **use** a cotton swab or a soft cloth to clean the area.
4. **If ports are clogged**, clean with a straight pin. **Do not enlarge or distort port. Do not leave anything stuck in the ports.**
5. **After cleaning** the gas tube opening and ports, **replace** the burner cap. **To replace burner cap, make sure** cap is properly aligned and leveled.
6. **Check** the burner after cleaning for proper lighting.



Caring for Your Gas Sealed Burner Cooktop

Cleaning chart

Use this chart for proper and effective cleaning of your sealed burner cooktop.

	! WARNING
	<p>Explosion Hazard</p> <p>Do not store flammable materials such as gasoline near this appliance.</p> <p>Doing so can result in death, explosion, or fire.</p>

PART	WHAT TO USE	HOW TO CLEAN
Control knobs	Sponge and warm, soapy water	<ul style="list-style-type: none"> • Turn knobs to OFF and pull straight away from control panel. • Wash, rinse, and dry thoroughly. Do not soak. • Do not use steel wool or abrasive cleansers. They may damage the finish of the knobs. • Replace knobs. Make sure all knobs point to OFF.
Tempered glass surface	Sponge and warm, soapy water OR Paper towel and spray glass cleaner	<ul style="list-style-type: none"> • Remove grates. • Wash, wipe with clean water, and dry thoroughly. • Use nonabrasive, plastic scrubbing pad on heavily soiled areas. • Do not use steel wool, abrasives, or harsh cleansers. They may damage the finish. • If you use soap or detergent solutions, rinse thoroughly to prevent filmy residue. <p>NOTE: When cleaning cooktop with knobs removed, do not allow water to run down inside unit.</p> <ul style="list-style-type: none"> • Replace grates.
Surface burner grates and caps	Warm, soapy water and a mildly abrasive plastic scrubbing pad and/or powdered cleanser	<ul style="list-style-type: none"> • Clean as soon as they become dirty and when they are cool enough to handle. • Wash with a mildly abrasive plastic scrubbing pad and warm, soapy water. • For stubborn stains, clean with a scrubbing pad and/or a powdered cleanser and water. Repeat these cleaning steps as needed.
Surface burners		See "Caring for Your Cooktop" earlier in this section for cleaning instructions.

Electric Grill

Use

In This Section	Page	Page	
Power on lights	27	Grill	27
Grill markers	27		

Your electric grill gives you that outdoor flavor in the convenience and comfort of your home. To get the most out of your grill, please review this section carefully.

Power on lights

The Power On Lights on the control panel glow when a grill element is turned on. The back light works with the rear grill element, while the front light works with the front grill element.

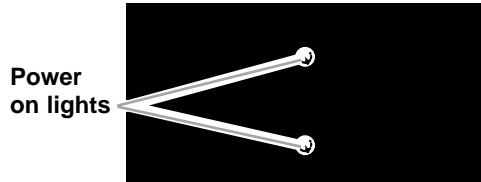

Grill markers

The solid dot in the grill marker shows which grill element (rear or front) is operated by the control knob.

To set the control knob, push in and turn to the desired setting. (See "Grill chart" on page 30 for recommended settings for commonly cooked foods.)

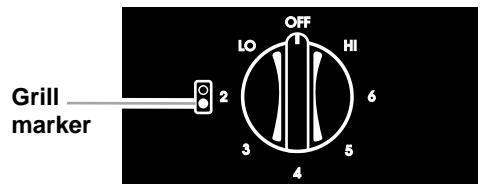

Grill

⚠ WARNING



Fire Hazard

Turn off all controls when done cooking.

Failure to do so can result in death or fire.

Before you use the grill for the first time:

Wash with warm, soapy water and a soft cloth, rinse, and dry. You can also use soapy plastic scrubbing pads on the grill.



Using Your Electric Grill

Grill chart

Preheat 10 minutes on HI for best results. Then use the chart below to help you select a grill setting and cooking time. Grilling times are approximate and may need to be adjusted to individual tastes.

FOOD	SETTING	GRILLING TIME (in minutes)	
		SIDE 1	SIDE 2
Beef steak (½-¾")			
• rare	HI	5-8	5-6
• medium	HI	10	8
• well-done	HI	14	12
Beef steak (1")			
• rare	HI	8-9	6
• medium	HI	9-11	10
• well-done	HI	15-16	14
Hamburgers	6	20-25*	
Hot dogs	6	10-15*	
Pork chops	6	25-35*	
Spare ribs, barbecued	6	50-60*	
Lamb chops	HI	25-35*	
Chicken pieces	HI	45-60*	
Ham slices	5	20-25*	
Garlic bread	HI	3-5*	

*Total grilling time. Turn food as needed.

Cooking tips

• **Do not cover** the entire cooking surface with meat. Leave space between the food items to allow smoke and steam to ventilate properly.

- **Meat with a normally high fat content** will produce more smoke and flare-ups. Trim fat from meat before placing on the grill to prevent excessive smoke or flare-ups.
- **If meat begins to cook** too quickly, turn the grill control knob to a lower setting.
- **Do not leave grill** unattended.
- **Move meat** around and turn as needed for even cooking.
- **Brush** on barbecue sauce during last 5-10 minutes of cooking, if desired.
- **Butter French bread** and sprinkle with garlic salt before grilling.
- **You can use** one or both elements, depending upon the amount of food you are grilling.

NOTE: To remove smoke that may be produced, use your vent system (updraft or downdraft). Different vent systems can affect cooking results. Grilling times may need to be adjusted depending on the type of vent system used and the vent fan speed. For example, you may need to extend grilling times when using a downdraft vent system.

! WARNING



Fire Hazard

Grease can cause large flare-ups.

To put out fire:

Make sure vent system has been switched on.

Turn grill control off, cover grill with large metal pan, and remove food from grill.

Do not put water on a grease fire.

To prevent fire and burns:

Do not use pots or pans on grill. They will become very hot.

Failure to follow these instructions can result in death, fire, or burns.



Care

In This Section

	Page	Page
Steps to follow	29	Cleaning chart
		30

Your grill is designed for easy care. You can do most cleaning with items found around your home. Cleaning your grill whenever spills or soiling occurs helps to keep it looking and operating like new.

Steps to follow

Food cooked on the grill may spatter. Clean all parts of your grill, except the heating element, after each use. A soiled heating element cleans itself by burning off spills and spatters.

To remove grill:

1. **Lift off** grate.
2. **Lift** heating element slightly.
3. **Pull** heating element away from you to unplug terminal from receptacle.

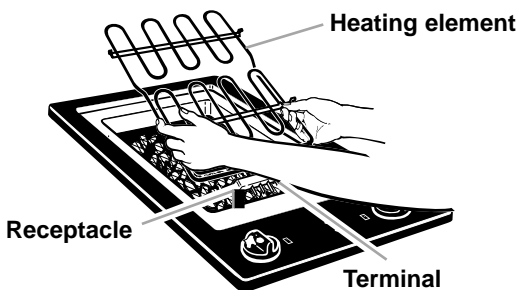
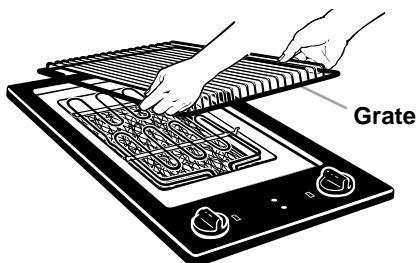



Caring for Your Electric Grill

4. **Lift out** rock pack.

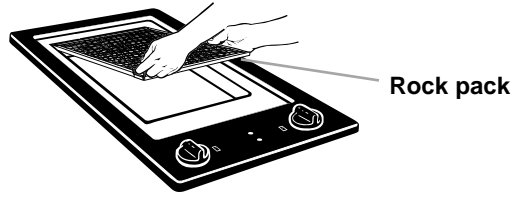

5. **Lift and remove** the grease pan, being careful not to spill drippings.

Wash grate with warm, soapy water and a nonabrasive plastic scrubbing pad. Use a wet, soapy steel-wool pad for heavily soiled areas. Rinse and wipe dry.

Wash the rock pack and grease pan in warm, soapy water. Use a plastic scrubbing pad for heavily soiled areas. Rinse and wipe dry. The grease pan and rock pack may be cleaned in a dishwasher. To remove stains from rocks in rock pack, place in an oven (on oven rack) during the Self-Cleaning cycle.

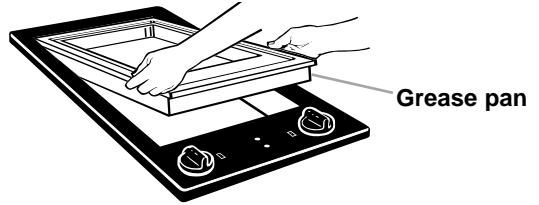

To replace grill:

1. **Lower** the grease pan into opening.
2. **Put in** rock pack.

3. **Plug** heating element terminal into receptacle.
4. **Place** grate over heating element.

Cleaning chart

Use this chart for proper and effective cleaning of your grill.

PART	WHAT TO USE	HOW TO CLEAN
Control knobs	Warm, soapy water and a sponge	<ul style="list-style-type: none"> • Wash, rinse, and dry well. • Do not soak. • Do not remove seals under control knobs.
Grate and grease pan	Warm, soapy water and a nonabrasive plastic scrubbing pad	<ul style="list-style-type: none"> • Clean after each use. • Wash, rinse, and dry. • Do not use metal scouring pads or harsh cleansers. • Grease pan may be cleaned in a dishwasher.
Heating element		<ul style="list-style-type: none"> • Do not clean. Do not put element in water. Soil burns off.
Rock pack	Warm, soapy water and a sponge	<ul style="list-style-type: none"> • Wash, rinse, and dry, or place in a dishwasher. • For heavy stains, place in an oven (on oven rack) during the Self-Cleaning cycle. Follow instructions in your oven Use and Care Guide.

Side Mount Downdraft Vent System

Use

Using the cooktop's downdraft vent system removes cooking vapors, odor, and smoke. Always turn on the vent fan when using the grill.

When using surface units or burners, turn the Vent Fan control knob clockwise to HI or LO. You will hear a click when the fan comes on. Turn counterclockwise to turn the fan OFF.

The fan filter must be in place for the fan to operate properly.

NOTE: Extend cooking times as needed when using the downdraft vent system.

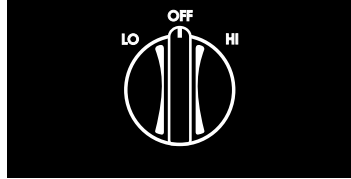

⚠ WARNING



Cut Hazard

Do not put hands into vent when fan or controls are on.

Doing so can result in serious cuts.



Care

In This Section

	Page	Page
Steps to follow	32	Cleaning chart
		33

Your vent system is designed for easy care. You can do most cleaning with items found around your home. Cleaning your vent system regularly will help to keep it operating like new.

Steps to follow



⚠ WARNING

Electric Shock Hazard

Disconnect power before servicing.

Turn fan and cooktop controls off before cleaning the vent system.

Do not put hand into vent when fan or controls are on.

Failure to follow these instructions can result in death, electrical shock, or cuts.

1. **Disconnect** power.
 2. **Remove** the vent cover and **wash** in warm, soapy water or **wipe** with a damp sponge. **Do not use metal scrubbing pads or abrasive cleansers.**
 3. **Lift up** vent filter, which is directly below vent cover. **Wash** in warm, soapy water or dishwasher.
- NOTE:** Use care when washing the vent filter in a dishwasher. Do not place vent filter near hard or sharp objects that could cause the filter to bend.
4. **Wipe** in and around the vent box with a damp cloth. **Clean up** spills with a sponge.
 5. **Replace** the vent filter. **Be sure** the vent filter is replaced flat and rests on side edges of trim. Do not replace vent filter at an angle.
 6. **Replace** the vent cover.
 7. **Reconnect** power.

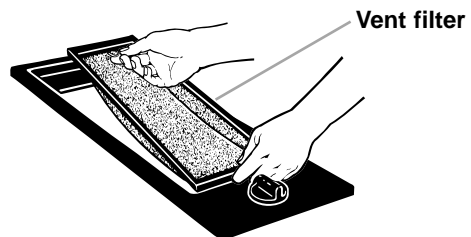
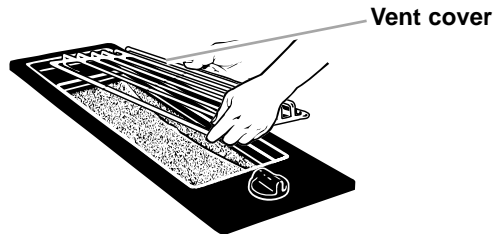



NOTE: Vent filter must be in place for the fan to operate properly. Replacement filters can be ordered from a KitchenAid servicer or dealer. Order Part Number 786220 (two filters). If you are unable to obtain the name of a local authorized KitchenAid servicer, call our toll-free Consumer Assistance Center telephone number 1-800-422-1230.

Cleaning chart

Use this chart for proper and effective cleaning of your vent system.

PART	WHAT TO USE	HOW TO CLEAN
Control knob	Warm, soapy water and a sponge	<ul style="list-style-type: none"> • Wash, rinse, and dry well. • Do not soak. • Do not remove seal under control knob.
Cover and filter	Warm, soapy water and a sponge; or a dishwasher	<ul style="list-style-type: none"> • Clean often. • Wash, rinse, and dry well.
Vent box	Warm, soapy water and a sponge	<ul style="list-style-type: none"> • Clean often. • Wipe out grease residue with a paper towel. Sponge out spills.

Troubleshooting

You can solve many common cooktop problems easily, saving you the cost of a possible service call. Try the suggestions below to see if you can solve your problem without outside help. If the suggestions do not work, see "Requesting Assistance or Service" on page 35.

PROBLEM	POSSIBLE CAUSE	SOLUTION
Nothing will operate	The unit is not wired into a live circuit with proper voltage. A household fuse has blown or a circuit breaker has tripped.	Wire the unit into a live circuit with proper voltage. (See Installation Instructions.) Replace household fuse or reset circuit breaker.
The surface cooking areas will not operate	A household fuse has blown or a circuit breaker has tripped. You are not setting the control knobs correctly.	Replace household fuse or reset circuit breaker. Push control knobs in before turning to a setting.
Control knob(s) will not turn	You are not pushing in before turning.	Push control knob(s) in before turning to a setting.
Cooking results are not what you expected	The cooktop is not level. The pan used is not the correct type or size. Cookware does not fit the surface cooking area being used.	Level cooktop. (See Installation Instructions.) Refer to a reliable cookbook for recommended pan type and size. Pan should be the same size or slightly larger than surface cooking area being used.

Requesting Assistance or Service

Before calling for assistance or service, please check the “Troubleshooting Guide” section. It may save you the cost of a service call. If you still need help, follow these instructions.

If you need assistance or service:

Call the KitchenAid Consumer



Assistance Center toll free: 1-800-422-1230.
Our consultants are available to assist you.

When calling:

Please know the purchase date, and the complete model and serial number of your appliance (see the “A Note to You” section). This information will help us to better respond to your request.

Our consultants provide assistance with:

- Features and specifications on our full line of appliances.
- Installation information.

- Use and maintenance procedures.
- Accessory and repair parts sales.
- Specialized customer assistance (Spanish speaking, hearing impaired, limited vision, etc.).
- Referrals to local dealers, service companies, and repair parts distributors.

KitchenAid service technicians are trained to fulfill the product warranty and provide after-warranty service, anywhere in the United States.

To locate the authorized KitchenAid service company in your area, you can also look in your telephone directory Yellow Pages.

If you need replacement parts

If you need to order replacement parts, we recommend that you only use factory authorized parts. These parts will fit right and work right, because they are made with the same precision used to build

every new KITCHENAID® appliance. To locate factory authorized replacement parts in your area, call our Consumer Assistance Center telephone number or your nearest authorized service center.

For further assistance

If you need further assistance, you can write to KitchenAid with any questions or concerns at:

KitchenAid Brand Home Appliances
Consumer Assistance Center
c/o Correspondence Dept.
2000 North M-63
Benton Harbor, MI 49022-2692

Please include a daytime phone number in your correspondence.

KitchenAid®

Cooktop

Warranty

LENGTH OF WARRANTY:	KITCHENAID WILL PAY FOR:	KITCHENAID WILL NOT PAY FOR:
ONE-YEAR FULL WARRANTY FROM DATE OF PURCHASE.	Replacement parts and repair labor costs to correct defects in materials or workmanship. Service must be provided by an authorized KitchenAid servicing outlet.	A. Service calls to: <ol style="list-style-type: none"> 1. Correct the installation of the cooktop. 2. Instruct you how to use the cooktop. 3. Replace house fuses or correct house wiring. 4. Correct house plumbing.
SECOND-THROUGH FIFTH-YEAR LIMITED WARRANTY FROM DATE OF PURCHASE.	Replacement parts for any electric element to correct defects in materials or workmanship. Replacement ceramic glass if breakage is due to defects in materials or workmanship.	B. Repairs when cooktop is used in other than normal home use. C. Damage resulting from accident, alteration, misuse, abuse, fire, flood, and acts of God, improper installation, or installation not in accordance with local electrical or plumbing codes. D. Any labor costs during the limited warranties. E. Replacement parts or repair labor costs for units operated outside the United States. F. Pickup and delivery. This product is designed to be repaired in the home. G. Repairs to ceramic glass cooktop if it has not been cared for as recommended in this Use and Care Guide. H. Repairs to parts or systems resulting from unauthorized modifications made to the appliance.

5/98

KITCHENAID DOES NOT ASSUME ANY RESPONSIBILITY FOR INCIDENTAL OR CONSEQUENTIAL DAMAGES. Some states do not allow the exclusion or limitation of incidental or consequential damages, so this exclusion or limitation may not apply to you.

This warranty gives you specific legal rights and you may also have other rights which may vary from state to state.

If you need service, first see the "Requesting Assistance or Service" section of this book. After checking "Requesting Assistance or Service," additional help can be found by calling our Consumer Assistance Center telephone number, **1-800-422-1230**, from anywhere in the U.S.