

Ceramic Glass Hob

Operating and Assembly Instructions

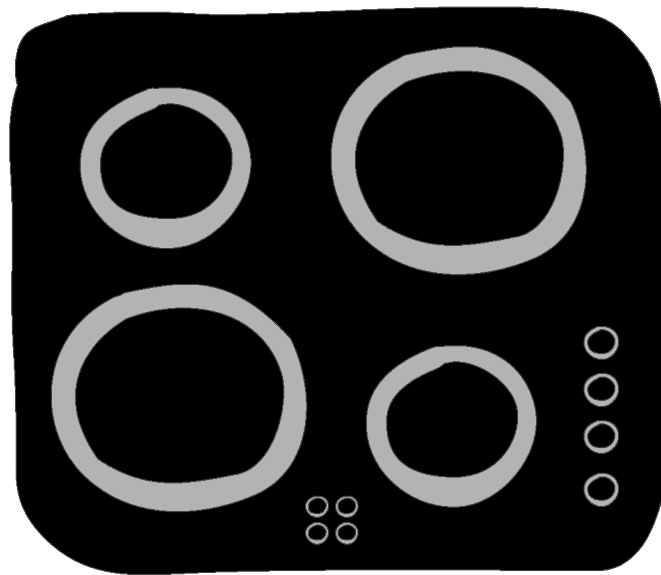

EHP 601 K

Dear Customer

Please read these instructions carefully for using your new appliance. Pay special attention to the chapter "Hints on safety".

Keep these instructions in a safe place for future reference and pass them on to any subsequent owner of the appliance.



The warning triangle and/or specific words (warning, caution, important) are used to highlight information that is important for your safety or the functioning of the appliance.



After this symbol you will find supplementary information on operating and practical use of the appliance.



Tips and instructions for the economical and environmentally sound use of the appliance are marked with this symbol.

These instructions contain informations on how to rectify faults yourself. See the section "What to do if ..."

Should you require further assistance, please contact your local Service Force Centre.

Customer Care Department
Electrolux
55-77 High Street
Slough
Berkshire
SL1 1DZ

Tel: 08705 950950*

* Calls to this number may be recorded for training purposes.

Help us to help you

To register your 12 month guarantee, please complete and return the enclosed guarantee card.

Content

For the user

Dear Customer	2
Safety information	4
Disposal	5
of packaging material	5
Hints of disposal	5
Description of the hob	6
Before the first use	6
Cleaning for the first time	6
Operating instructions	7
General information	7
Heat control knobs	7
Residual heat indicator	7
Application, charts, tips	8
Cooking and frying utensils	8
General hints	8
Energy consumption	8
Chart: boiling and frying	8
Cleaning and care	9
Ceramic glass surface	9
Light soilage	9
Stubborn soilage	9
Special soilage	10
Sugar	10
Dark spots and decor damages	10
Scratches in the ceramic glass surface	10
The hob frame	10
What to do ...	16
Guarantee conditions, Customer care	17

For the installer

Installation instructions	12
Hints on safety	12
Building into the kitchen worktop	12
Electrical connection	14
Technical data, rating plate	15

Important Safety Information

This information is provided in the interest of your safety. Please read it carefully before installing or using the hob. If you are unsure of any of these warnings please contact our Customer Care Department on 08705 950950.

Electrical safety

- This appliance must be installed by qualified personnel.
- Repairs to the appliance should only be carried out by authorised service engineers. Improper repairs can lead to injury or serious malfunction. If your appliance needs repairing please contact your local Service Force Centre.

i Please observe this instruction, otherwise the guarantee will not cover any damage that may occur.

- Built-in appliances must be installed in built-in cupboards and worktops. The cupboards have to be located and fastened in a way that they are stable. The protection against accidental contact required by the VDE will then be ensured.
- Damaged appliances must not be installed.
- Do not use the hob if the ceramic glass is damaged:
 - switch off the cooking zones,
 - disconnect from the electricity supply.

Safety for children

- This appliance is designed to be operated by adults only. Do not allow children to play with the product or tamper with the controls.
- The appliance gets hot when it is in use. Children should be kept away until it has cooled.
- Children can also injure themselves by pulling pots or pans off the hob.

Safety during use

- This hob is intended for domestic cooking only. It is not designed for commercial or industrial purposes.
- The appliance gets hot when in use. In case of careless handling there is **danger of burning** oneself at the heating zones.
- Do not use the cooking zones to heat the room.
- Take care when plugging electrical items into mains sockets near the hob. Connecting leads must not come into connection with the hot surface or vessels.

- Hot oils can ignite very quickly. Do not leave the hob unattended when preparing foods in pans of oil, i.e. frying chips.
- The sensor technique provides best-possible safety with the manipulation of the appliance, but to the same extent it needs care when setting cooking zones, output or periods of time.
- After use make sure that the appliance is switched off.

Safety when cleaning

- Ensure that all heating zones are switched off while cleaning the hob.
- For safety reasons do not clean the appliance with a steam jet or high pressure cleaner.

How to avoid damaging your appliance

- Do not use the hob surface as a working surface or for storage.
- Do not use the cooking zones with empty pans or without pans. This could cause damage to the pans or the hob.
- Ceramic glass is insensitive to temperature shock and very robust, however, it is not unbreakable. Hard and sharp objects, in particular, can damage the cooking surface if they fall on it.
- Do not use cast iron pots or pans with damaged bases that are rough or burred. Scratching may occur when the pans are slid.
- Do not place any pans on the hob frame. Scratching may occur or the paint damaged.
- Ensure that liquids containing acids, e.g. vinegar, lemon limescale removing agents do not come into contact with the hob frame, otherwise matt spots will appear.
- If sugar or a dish containing sugar comes into contact with a hot cooking zone and then melts, remove the soiling immediately whilst still warm, using a glass scraper. If it cools, damage to the surface may occur.
- Keep all items and materials that melt away from the ceramic glass surface, e.g. plastics, aluminium foil or oven foils. If something of this nature should melt onto the ceramic glass surface, it must be removed immediately using a glass scraper.

Disposal

Disposal of packaging material



All parts of the packaging can be recycled and hard foam parts are appropriately marked.

PE = Polyethylene

(outer wrapping and the bag inside)

PS = Polystyrene foam (eg. packing pieces)

Please dispose of all packaging and old appliances with due regard for safety and the environment.



Please observe the national and regional regulations on appliances and packing material as well as the material marking (material separation, refuse collection, waste disposal sites).

Hints on disposal



The appliance must not be disposed of with the household rubbish.

Please contact your local council or Environmental Health Office to see if there are facilities in your area to recycle the appliance.

Description of the hob

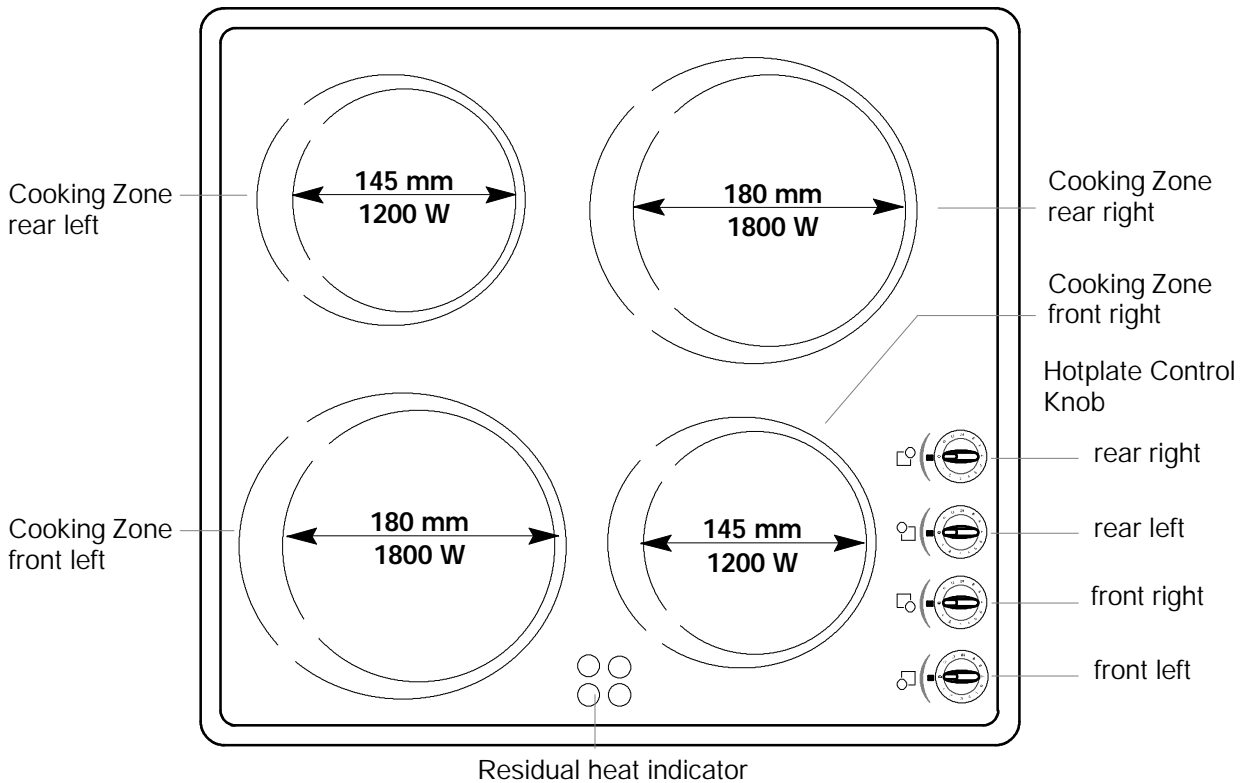

Before the first use

Cleaning for the first time

The hob has to be cleaned thoroughly before it is first used.

- Wash the ceramic glass surface and the frame with warm water with a little washing up liquid added and wipe dry.

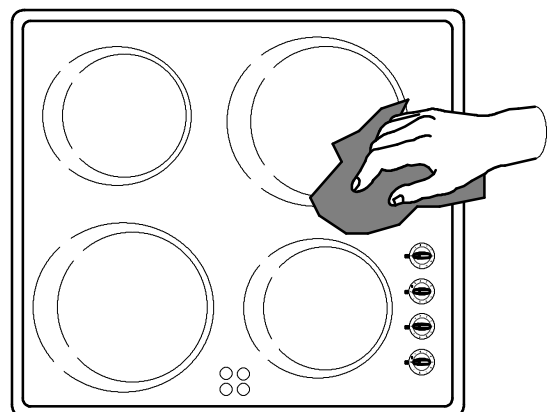

 Never use aggressive or abrasive cleaning agents, they may damage the ceramic glass and hob frame.



Operating Instructions

General information

The cooking surface is made of proven ceramic glass and consists of 4 cooking zones. The rapid glowing cooking zones are especially efficient radiant heating elements which will considerably reduce the duration of heating-up.

-  The cooking surface is insensitive to rapid changes in temperature. Pots can therefore be moved from a hot to cold zone.
-  When switching on a cooking zone you may hear a short buzz. That is a characteristic of all ceramic glass cooking zones and does not impair the function or the lifetime of the appliance.
-  Always put pots and pans onto the cooking zone before switching on.

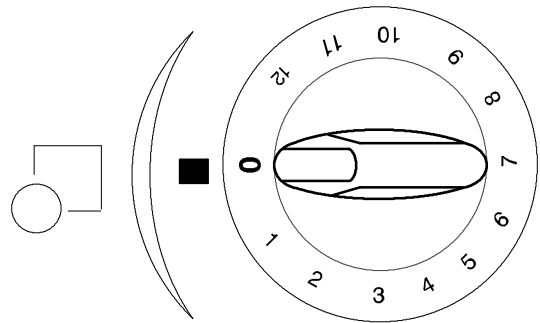

Heat Control Knobs

The control knobs regulate the heating capacity of the cooking zones.

The control knobs for the cooking zone can be turned to the left and to the right to the desired position.

- 1 = minimum setting
- 12 = maximum setting.

Setting it back to „0“ turns off the cooking zone.

Always put pans or pots on the cooking zones, before switching on.

Residual heat indicator

Each cooking zone is related to one indicator. The warning lamp lights up when the surface of the corresponding cooking zone reaches a temperature which could cause burns.

This light remains lit after the relevant zone has been switched off as long as the residual heat of the corresponding cooking surface can cause burns. The light will go out when the temperature falls below 60 °C.

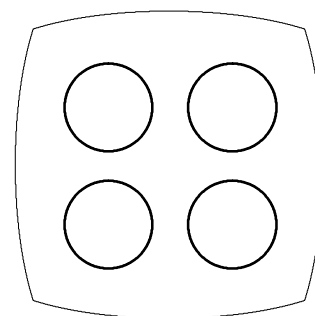

Application, Charts, Tips

Cooking and frying utensils

i The better the pot or the pan, the better the boiling or frying result.

- You can recognise good quality pans by their base. The base should be thick and as flat as possible.
- Rough bases (i.e. burrs and sharp edges) will scratch the ceramic glass surface.
- Utensils with aluminium and copper bases can leave behind metallic discolourations which can only be removed with difficulty or sometimes not at all.
- Saucepans and frying pans should not be smaller than the cooking zone, and preferably not more than 10–15 mm larger than the diameter of the cooking zone.
- When cold, pan bases normally curve slightly inwards (are concave). In no case should they curve outwards (be convex).
- When buying new pots or pans pay attention to the base diameter. Manufacturers often state the upper diameter of the edge of a dish.
- If you are using special cooking utensils like pressure cookers or a WOK, follow the manufacturer's instructions.
- Follow any guidelines provided by the saucepan manufacturer. Ensure they are recommended for use on ceramic hobs.

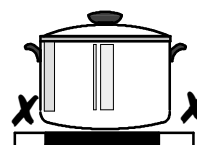
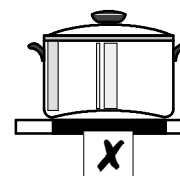
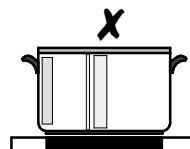
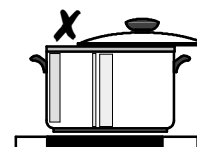
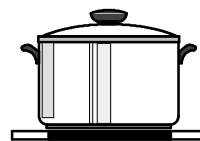

General hints

- The bases should always be clean and dry.
- To avoid scratching or damaging the ceramic glass surface, pots and pans should be moved on the hob by lifting them, and not by sliding.
- Scratches can also be caused by grains of sand (e.g. originating from the previous washing of vegetables), drawn over the cooking surface with the pan, or by burrs and the rims of pan bases.
- Use high sided pans for dishes with a lot of liquid, so that nothing boils over.

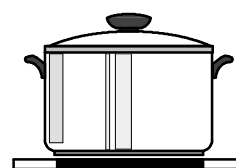

Energy consumption

To save energy, you should:

- place pots and pans in position before switching on the cooking zone.
- use only cooking and frying utensils with smooth, flat bases.

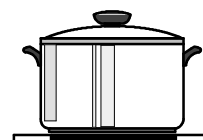

- wherever possible, cover pots and pans with a lid.
- never place pots or pans on cooking zones with a larger diameter.
- wet or dirty cooking zones and pots will waste energy.
- switch off the cooking zone a few minutes before the end of the cooking time, in order to make use of the residual heat.
- When using pressure cookers you can reduce the cooking time by up to 50%. As well as saving energy, more vitamins and minerals are retained in the food.

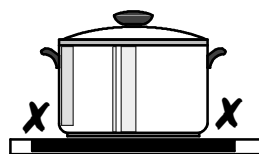
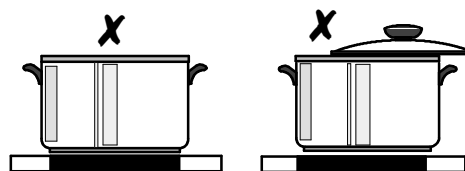

Chart: Boiling and frying

i The setting position required for cooking processes is dependent on the quality of the pots and on the type and amount of the food.

Switch position	Cooking method	Examples
12	Parboiling Quick frying	Starting of cooking and roasting, cooking of large quantities of liquid, then switch-back to appropriate setting
10-11	Frying Deep fat frying	French fries, pan cakes Fillet of pork and beef, steaks goulash
8-10	Roasting Frying without crust	Frying of meat, schnitzel, cutlets, meat-balls, sausages, liver, fish-fillet in deep fat, Frying eggs or chops
4 - 7	Boiling Braising	Boiled potatoes, stews, soups, hot-pot, sauces in large quantities
3 - 5	Simmering Stewing	Simmering of vegetables, braising of meat, lightly cooking small amount of fruit with little liquid
1 - 3	Gentle simmering	Simmering of rice and food with milk (sometimes stirring), Stewing of smaller amount of potatoes or vegetables, Warming up of prepared meal
1-2	Keeping warm Melting	Omelette, fried eggs, Hollandaise sauce, Keeping warm a meal or small amount of hot-pot Melting of butter, chocolate, gelatine.
0	Residual heat	Residual heat, OFF-position

i When heating up or frying, we recommend heat setting "10-12", and then continue cooking foods at an appropriate lower heat setting.

Cleaning and care

⚠ Attention! Cleaners must not get onto the **hot** ceramic glass surface! After cleaning all residues of cleaners must be removed with sufficient clean water, as they may be caustic when being reheated.

Never use aggressive or abrasive agents, such as oven sprays, stain or rust removers, scouring powder, or sponges with an abrasive effect.

i Suitable cleaning materials are: clean cloth or household paper, hot water with detergent, suitable commercial cleaners and cleaning scrapers. Cleaning scrapers and ceramic glass cleaners are available from the expert trade and in markets for building material.

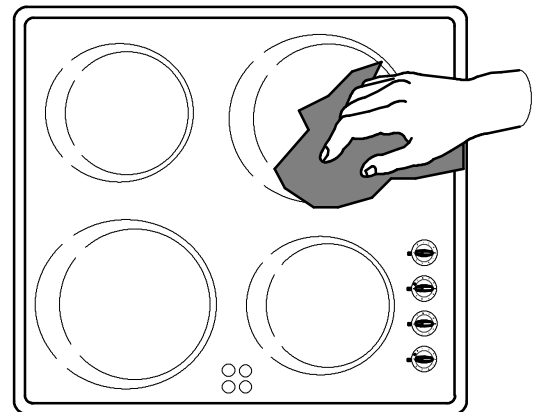
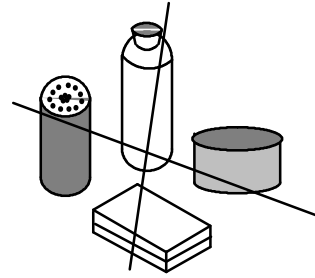

Ceramic glass surface

- Clean the ceramic glass surface after every use when it is hand warm or cold. This will avoid spills becoming burnt on.
- Remove scale and water marks, fat spots and metallic shimmering discoloration with a commercial ceramic glass cleaner such as Vitroclen.

Light soilage

- Wipe the ceramic glass surface with a damp cloth, and a little washing up liquid.
- Then rub dry with a clean cloth. No residues of cleaner must be left on the surface.
- Once a week, thoroughly clean the entire ceramic glass surface with a commercial ceramic glass cleaner such as "Vitroclen". Always ensure that the hob is dry after cleaning.

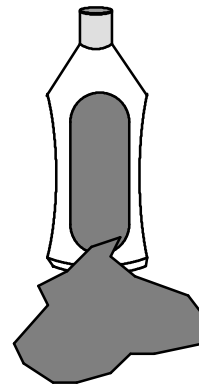

Stubborn soilage

- To remove food that has boiled over or burnt on spots, use a glass scraper.
- Place the glass scraper at an angle to the ceramic glass surface. Remove soiling by sliding the scraper.

Special soilage

Sugar

- Remove burnt-on sugar, melted plastics, aluminum foil immediately - when they are **still warm** - using a glass scraper, otherwise damage may be caused.

 Warning! When using the cleaning scraper on the warm cooking zone care should be taken.

- Afterwards clean the cooking surface normally.

 If the cooking zone and melted material has cooled down, reheat the cooking zone gently to aid the cleaning process.

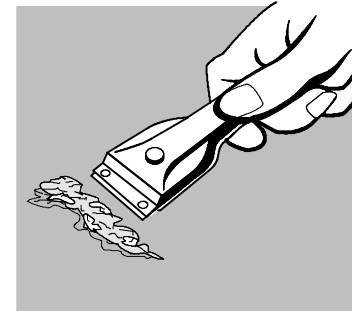
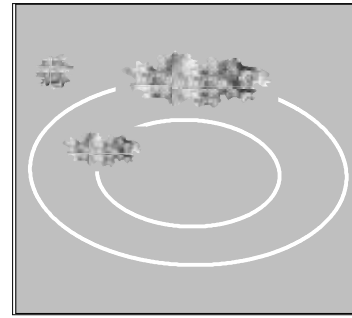

Dark spots, decor damages

 If aggressive cleaners or pans with abrasive bases are used, then the decor will take on an abraded appearance and dark spots will appear over time.

These marks cannot be removed. However, they do impair the functionality of the hob.

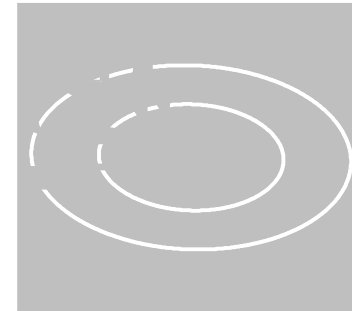

Scratches in the ceramic glass surface

 Scratches in the ceramic glass surface resulting from burrs on a pan base or sand grains cannot be removed.

However, they do not impair the function of the hob.

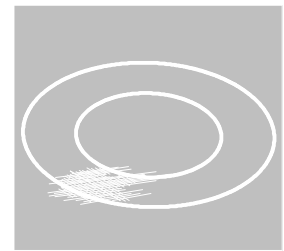
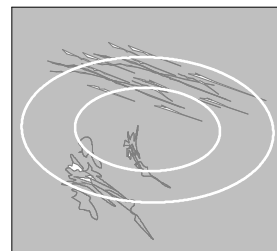

The hob frame

 Do not allow vinegar, lemons or scale removers to come into contact with the hob frame, matt spots will appear.

- Clean the hob frame with water and a little washing up liquid.
- Soften dried dirt with a wet cloth. Then wipe off and rub dry.

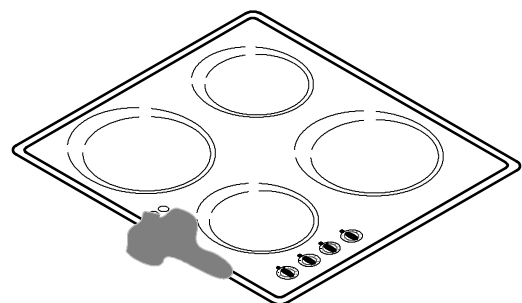

Installation instructions

Hints on safety

⚠ This appliance must be installed and connected by a qualified electrician or competent person. Please observe this instruction, otherwise the warranty will not cover any damage which may occur.

During the installation and in case of a service failure the appliance must not be connected to the mains.

The general rules for the operation of electric appliances, the provisions by the competent electricity supply board and the specifications of these instructions for installation have to be strictly adhered to.

Building into the kitchen worktop

⚠ Electrical safety is to be ensured by professional installation.

Protection against accidental contact according to the regulations set by VDE or other local authorities must be ensured by correct installation of the appliances. The same refers to the back of the appliance which, even in case of built-in installation away from the wall, must not be freely accessible.

Built-in cupboards have to be located and fastened in a way that they are stable.

- Note down the data from the rating plate of your appliance in the printed rating plate form in this manual. These numbers are needed in case of service calls.

Installation dimensions

The opening in the cabinet must correspond to the standard dimensions. The necessary information can be found in the dimensional sketch.

- The separation between the lower surface of the hob and the parts of the furniture below it must be at least 20 mm
- The lateral separation between the sides of the hob and the cabinet must be at least 50 mm, and must be at least 55 mm from the rear panel.

i With regard to the protection against overheating of surrounding furniture surfaces this appliance corresponds to type Y. This appliance or the built-in cupboard for the appliance respectively may be located with the rear wall and one side wall to whatever high walls or furniture respectively and with the other side to another appliance or furniture of the same height as this appliance.

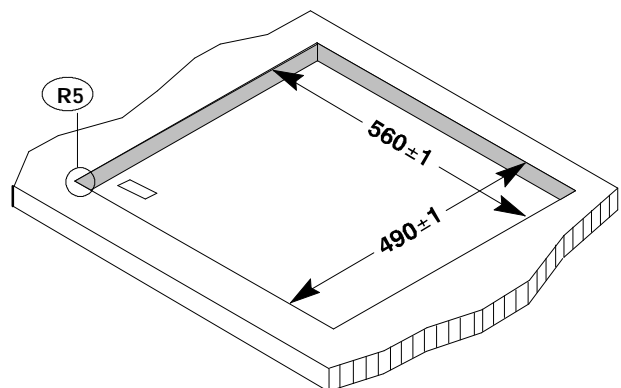
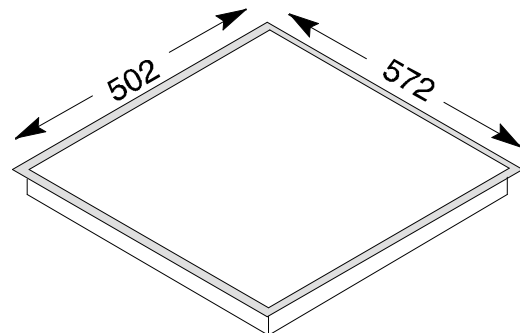
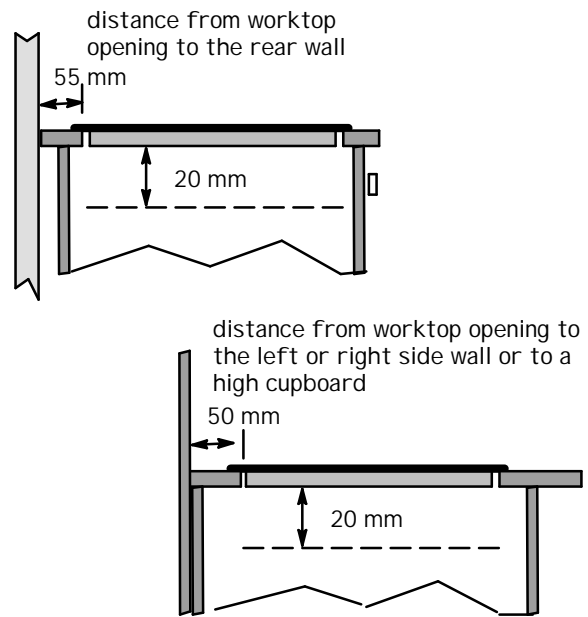

Hob installation

- Cut out the worktop according to the cutout size. The tolerances must not be exceeded. Precisely saw at the marked line.
- With tile-coated worktop areas any slits in the surface of the cooking area must be filled up completely.
- Clean the worktop in the cutout area
- The hob is fitted from the top into the cut-out section, centered and firmly pressed on until the springs will catch.
- Check the sealing in the supporting frame for perfect seating and resting without a gap. **Please do not apply additional silicone sealing material.** It will make it harder to dismantle the hob in case of service.
- 5 holes in the bottom of the build-in case are provided for the screws of the fitting plates.
- At first screw on the fitting plates with a screwdriver and afterwards tighten the plates alternatively and diagonally, until the frame of the cooking area is perfectly laying on the worktop.
- Over-tightening must be avoided! Electric screwdrivers are to be exclusively used with slip clutch (setting value 1 - 1.1 Nm).

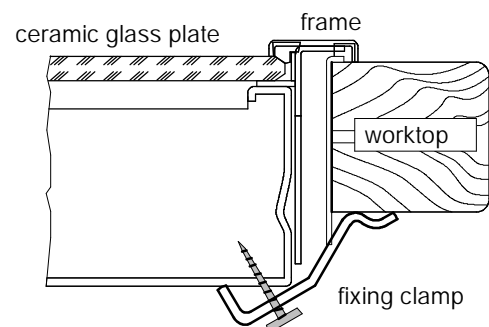
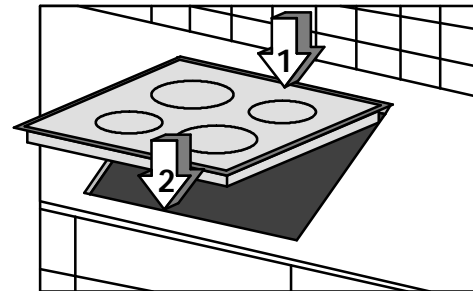
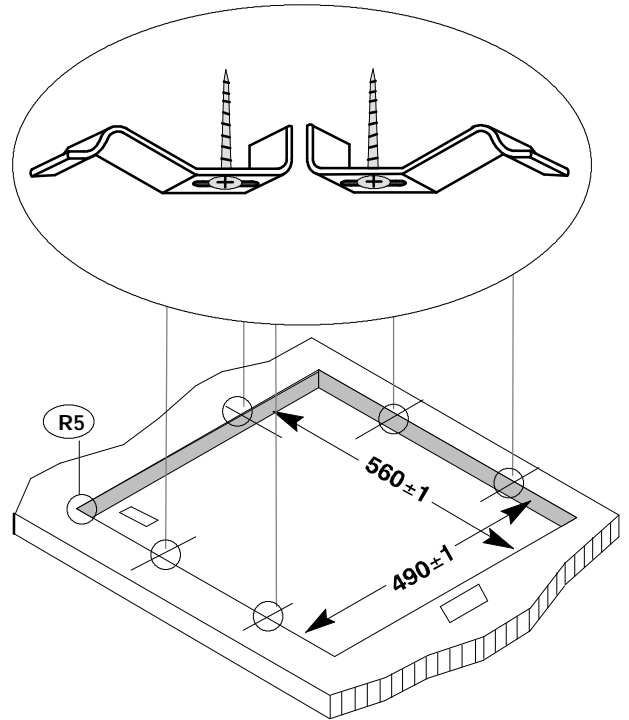

Electrical connections







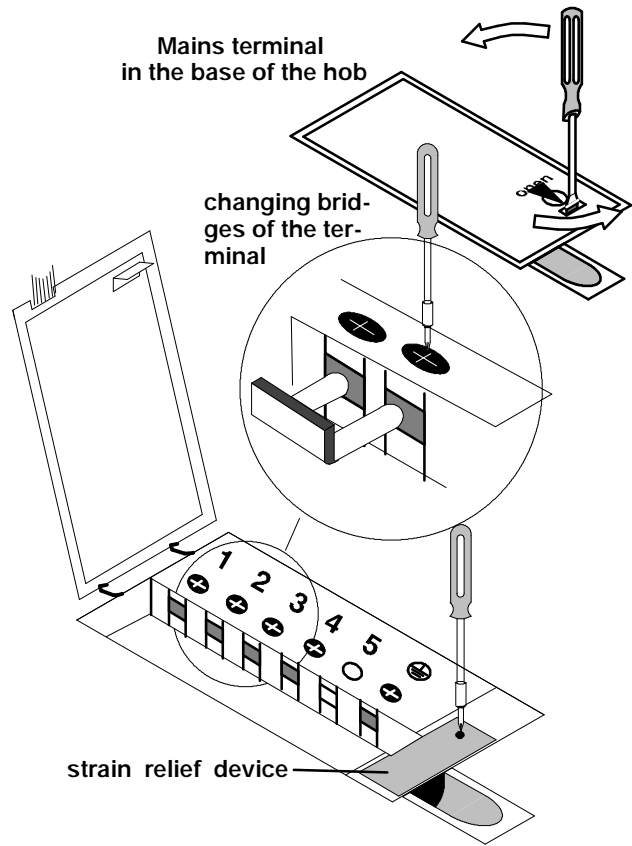

⚠ Before connecting the appliance, check that the voltage quoted on the rating plate - that is, the nominal voltage of the appliance - corresponds to the available mains voltage. The rating plate can be found on the base of the ceramic glass hob.

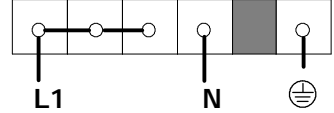
- The mains connection must be carried out by an expert electrician. The VDE-regulations and the valid regulations by the local electricity supply boards have to be complied with.
- Prior to connection it should be checked whether the voltage stated on the rating plate - i.e. the nominal voltage of the appliance - is identical with the mains voltage. The rating plate is located on the base of the hob.
- The heating element voltage is to 230 V ~. The appliance will also perfectly perform with the lower mains voltage of 220 V ~.
- The mains connection must be carried out in a way that an all-pole insulating device is existing with a contact opening of at least 3 mm, e.g. LS-automatism, earth-leakage circuit-breaker or fuse.
- A wire of type H05VV-F or of higher rating is to be used as supply cable.
- The mains terminal is located in the bottom of the appliance under a plastic cover. It can be opened using a screwdriver (see picture).
- Subject to the existing mains voltage, the appliance has to be connected as shown opposite. The links of the terminal block must be changed accordingly, if appropriate.
- The earth conductor is to be connected to terminal . The earth conductor must be longer than live leads.
- **The cable connections have to be connected as shown and the terminal screws be firmly tightened.**
- Afterwards the supply cable has to be secured by the cable clamp and the cover must be fitted by firmly pressing down until it engages.

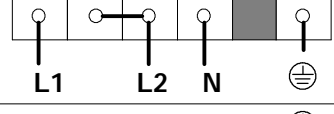
⚠ Prior to first use remove any existing labels and protective film from the ceramic glass plate or the frame of the hob.

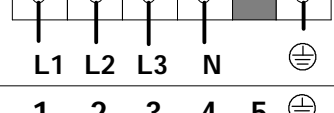
After connecting the electrical supply, all cooking zones should be briefly switched on one after the other at their maximum power, in order to test whether they are operational.

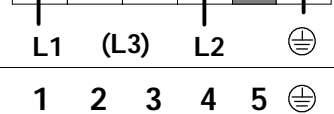

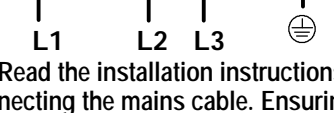
Connecting possibilities						
1	2	3	4	5		UK only 230 V ~
						1 L + N
1	2	3	4	5		400 V 2 N ~
						2 L + N
1	2	3	4	5		400 V 3 N ~
						3 L + N
1	2	3	4	5		230 V 2 ~
						2 L
1	2	3	4	5		230 V 3 ~
						3 L

Read the installation instructions before connecting the mains cable. Ensuring that the links are fitted correctly to the terminal block

Technical data

Dimensions of the appliance :

Length	572 mm
Depth	502 mm
Height	49 mm

Cut-out dimensions

Length	560 mm
Depth	490 mm
Radius	R5

Power of cooking zones:

Cooking zone front left	1800 W
Cooking zone rear left	1200 W
Cooking zone rear right	1800 W
Cooking zone front right	1200 W

Total connected load max. 6,0 kW

Voltage 230 V ~50 Hz

Specifications, Standards, Guidelines

This appliance corresponds to the following standards:

- EN 60 335-1 and EN 60 335-2-6 with regard to the safety of electric appliances for domestic use and similar purposes
- DIN 44546 / 44547 / 44548 with regard to the criteria for electric cookers for domestic use.
- EN 55014-2 / VDE 0875 part 14-2
- EN 55014 / VDE 0875 part 14 / 12.93
- EN 61000-3-2 / VDE 0838 part 2
- EN 61000-3-3 / VDE 0838 part 3 with regard to the basic protection demands for electromagnetic compatibility (EMC).



This appliance corresponds to EC-guidelines

- 73/23/EC dt. 19.02.1973 (low-voltage-guideline)
- 89/336/EC dt. 03.05.1989 (EMC-guideline inclusive of amendment-guideline 92/31/EC)

Rating plate

Note down here the data from the rating plate of your appliance. The rating plate is on the base of the hob. The rating plate is not visible after the hob has been built-in.

This information will be required:

- when requesting a service call
- when ordering spare parts or accessories
- with technical queries.

Modell	EHP 601 K	Prod.Nr.	949 590 492
Typ:	PEE2 001	230 V AC 50 Hz	
Made in Germany	F.Nr.:	6,0 kW	

Something not working

If your hob is not functioning correctly please carry out the following checks before calling out an engineer.

Important: If you call out an engineer to a fault listed below, or to repair a fault caused by incorrect use or installation, a charge will be made even if the appliance is under guarantee.

Symptom	Possible Solution
<ul style="list-style-type: none"> The cooking zones do not function 	<ul style="list-style-type: none"> Check the mains fuse has not failed Check a power level has been selected
<ul style="list-style-type: none"> After switching off a cooking zone the hob hot indicator is not illuminated 	<ul style="list-style-type: none"> The cooking zone may have only been switched on for a short while, and is therefore below 60 °C
<ul style="list-style-type: none"> A buzzing is heard when a cooking zone is switched on 	<ul style="list-style-type: none"> This is not a fault, the buzzing will reduce as the zone heats up
<ul style="list-style-type: none"> Discolourations appear in the cooking zone 	<ul style="list-style-type: none"> This is probably a result of burned on remnants that have not been removed regularly. They will not affect the function of the hob.

If after carrying out the above checks there is still a fault, contact your local Electrolux Service Force Centre.

Service and Spare Parts

If you require an engineer or you wish to purchase spare parts contact your local Electrolux Service Force Centre by telephoning:

08705 929929

Your call will be routed to the Service Centre covering your post code area. The addresses are listed on the pages headed Electrolux Service Forces Centres.

When you contact the Service Centre you will need to give the following details:

- 1 Your name, address and post code.
- 2 Your telephone number.
- 3 Clear and concise details of the fault.
- 4 The model and serial number of the appliance (Found on the rating plate).
- 5 The purchase date.

In guarantee customer should ensure that the checks listed in „Something not working“ have been made as the engineer will make a charge if the fault is not a mechanical or electrical breakdown.

Customer Care

For general enquiries or for further information on Electrolux products, please contact our Customer Care Department.

Electrolux
55-77 High Street
Slough
Berkshire
SL1 1DZL

Tel: 08705 950950*

*Calls to this number may be recorded for training purposes.

Guarantee Conditions

Standard guarantee conditions

We, Electrolux, undertake that if within 12 months of the date of the purchase this Electrolux appliance or any part thereof is proved to be defective by reason only of fault workmanship or materials, we will, at our option repair or replace the same FREE OF CHARGE for labour, materials or carriage on condition that:

- The appliance has been correctly installed and used only on the electricity supply stated on the rating plate.
- The appliance has been used for normal domestic purposes only, and in accordance with the manufacturer's instructions.
- The appliance has not been serviced, maintained repaired, taken apart or tampered with any person not authorised by us.
- All service work under this guarantee must be undertaken by an Electrolux Service Force Center.
- Any appliance or defective part replaced shall become to Company's property.
- This guarantee is in addition to your statutory and other legal rights.

Home visits are made between 8.30 am and 5.30 pm Monday to Friday. Visits may be available outside these hours in which case a premium will be charged.

Exclusions

This guarantee does not cover:

- Damage or calls resulting from transportation, improper use or neglect, the replacement of any light bulbs or removable parts of glass or plastic.
- Costs incurred for calls to put right an appliance which is improperly installed or calls to appliances outside the United Kingdom.
- Appliances found to be in use within a commercial environment, plus those which are subjected to rental agreements.
- Products of Electrolux manufacture which are not marketed by Electrolux.

European Guarantee

If you should move to another country within Europe then your guarantee moves with you to your new home subject to the following qualifications:

- The guarantee starts from the date you first purchased your product.
- The guarantee is for the same period and to the same extent for labour and parts as exists in the new country of use for this brand or range of products.
- This guarantee relates to you and cannot be transferred to another user.
- Your new home is within the European community (EC) or European Free Trade Area.
- The product is installed and used in accordance with our instructions and is only used domestically, i.e. a normal household.
- The product is installed taking into account regulations in your new country.

Before you move please contact your nearest Customer Care Center, listed below, to give them details of your new home. They will then ensure that the local Service Organisation is aware of your move and able to look after your appliances.

France	Senlis	+33 (0)3 44 62 22 22
Germany	Nürnberg	+49 (0)911 3232 2600
Italy	Pordenone	+39 (0)1678 47053
Sweden	Stockholm	+46 (0)20 78 77 50
UK	Slough	+44 (0)1753 219898

© Electrolux Household Appliances Limited 2000

*IBNr.319 5725-00
PE-D 2000.11.27*