

EN User manual

2

Ceramic glass hob

USER MANUAL

ZVM64N

la vita è bella
ZANUSSI
ITALIAN SINCE 1916

Contents

Safety information _____	2	Helpful hints and tips _____	6
Installation _____	2	Care and cleaning _____	6
Description of the appliance _____	5	What to do if... _____	7
Operating the appliance _____	5	Environment concerns _____	7

Subject to change without notice

Safety information

 For your safety and correct operation of the appliance, read this manual carefully before installation and use. Always keep these instructions with the appliance even if you move or sell it. Users must fully know the operation and safety features of the appliance.

General safety

 **Warning!** Persons (including children) with reduced physical sensory, mental capabilities or lack of experience and knowledge must not use the appliance. They must have supervision or instruction for the operation of the appliance by a person responsible for their safety.

Child safety

- Only adults can use this appliance. Children must get supervision to make sure that they do not play with the appliance.
- Keep all packaging away from children. There is a risk of suffocation.
- Keep children away from the appliance when it is on.

 **Warning!** Start the child safety device to prevent small children and pets from an accidental activation of the appliance.

Safety during operation

- Remove all packaging, stickers and layers from the appliance before the first use.
- Set the cooking zones to "off" after each use.
- Risk of burns! Do not put cutlery or saucepan lids on the cooking surface, as they can become hot.

Installation

 **Before the installation**, note down this data from the rating plate:

- Model description (Modell).....

 **Warning! Fire danger!** Overheated fats and oils can ignite very quickly.

Correct operation

- Always monitor the appliance during operation.
- Only use the appliance for domestic cooking tasks!
- Do not use the appliance as a work or a storage surface.
- Do not put or keep very flammable liquids and materials, or fusible objects (made of plastic or aluminium) on or near the appliance.
- Be careful when you connect the appliance to the near sockets. Do not let electricity bonds touch the appliance or hot cookware. Do not let electricity bonds tangle.





How to prevent a damage to the appliance

- If the objects or cookware fall on the glass ceramic, the surface can be damaged.
- Cookware made of cast iron, cast aluminium or with damaged bottoms can scratch the glass ceramic if you move them on the surface.
- Do not let cookware boil dry to prevent the damage to cookware and glass ceramics.
- Do not use the cooking zones with empty cookware or without cookware.
- Do not cover any part of the appliance with aluminium foil.

 **Warning!** If there is a crack on the surface, disconnect power supply to prevent the electric shock.

- Product number (Prod. Nr.)
- Serial number (Ser. Nr.)

You find the rating plate of the appliance on its lower casing.

Modell ZVM 64N		Prod.Nr. 949 592 736 02	
Typ 58PEE11AO	220-240 V 50-60-Hz		
Made in Germany	Ser.Nr.	6,0 kW	
ZANUSSI		 	

Safety instructions

 **Warning!** You must read these!

Make sure that the appliance is not damaged because of transportation. Do not connect a damaged appliance. If it is necessary, speak to the supplier. Only an authorised service technician can install, connect or repair this appliance. Use only original spare parts. Only use built-in appliances after you assemble the appliance into correct built-in units and work surfaces that align to the standards.

Do not change the specifications or modify this product. Risk of injury and damage to the appliance.

Fully obey the laws, ordinances, directives and standards in force in the country where you use the appliance (safety regulations, recycling regulations, electrical safety rules etc.)!

Keep the minimum distances to other appliances and units!

Install anti-shock protection, for example install the drawers only with a protective floor directly below the appliance!

Protect the cut surfaces of the worktop against moisture with a correct sealant!

Seal the appliance to the work top with no space left with a correct sealant!

Protect the bottom of the appliance from steam and moisture, e.g. from a dishwasher or oven!

Do not install the appliance adjacent to doors and below windows! If not, hot cookware can be hit off the hob when you open doors or windows.

 **Warning!** Risk of injury from electrical current.

Carefully obey the instructions for electrical connections.

- The electrical mains terminal is live.
- Make electrical mains terminal free of voltage.
- Install correctly to give anti-shock protection.
- Loose and incorrect plug and socket connections can make the terminal become too hot.
- A qualified electrician must install the clamping connections correctly.
- Use a strain relief clamp on cable.
- Use the correct mains cable of type H05BB-F Tmax 90°C (or higher) for a single-phase or two-phase connection.
- Replace the damaged mains cable with a special cable (type H05BB-F Tmax 90°C; or higher). Speak your local Service Force Centre.

The appliance must have the electrical installation which lets you disconnect the appliance from the mains at all poles with a contact opening width of minimum 3 mm.

You must have correct isolation devices: line protecting cut-outs, fuses (screw type fuses removed from the holder), earth leakage trips and contactors.

Assembly

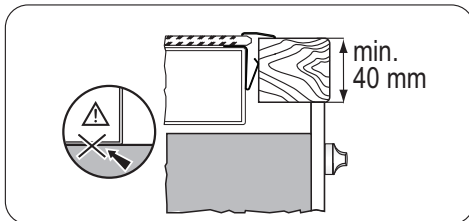
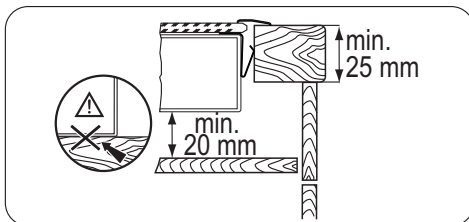
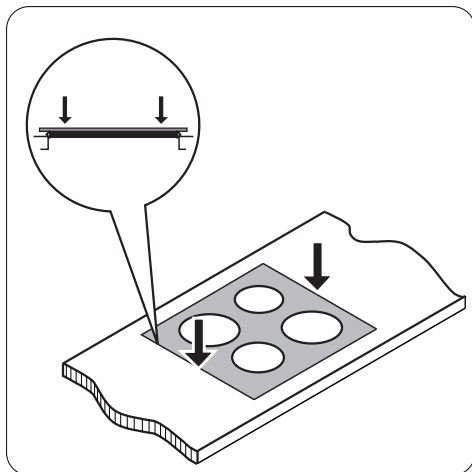
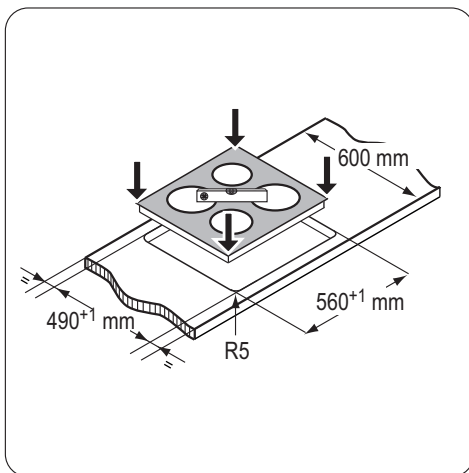
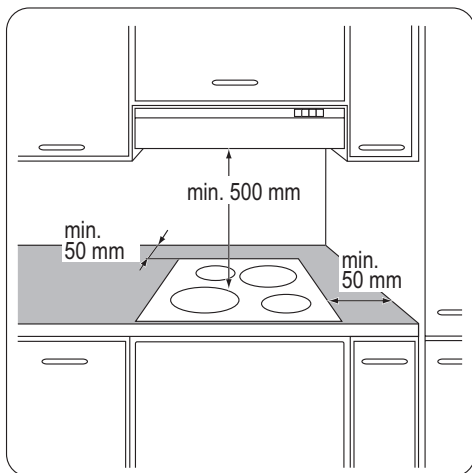

Description of the appliance

Cooking surface layout

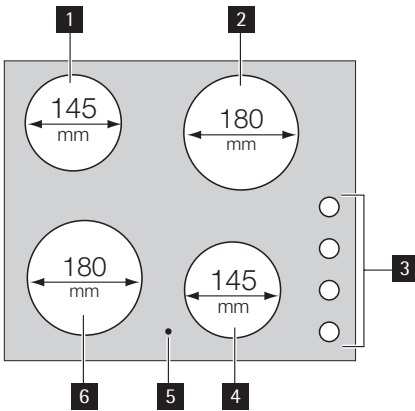

- 1** Single cooking zone 1200 W
- 2** Single cooking zone 1800 W
- 3** Control Knobs
- 4** Single cooking zone 1200 W
- 5** Residual heat indicator
- 6** Single cooking zone 1800 W

Hob cooking zone control knob

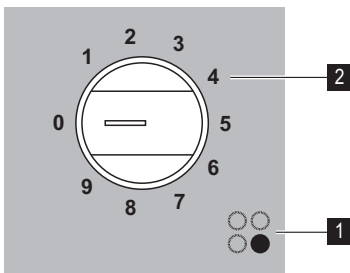

- 1** Assignment of control knobs
- 2** Heat setting (0-9)

Residual heat indicator

The residual heat indicator comes on when a cooking zone is hot.

Warning! Risk of burns from residual heat!

Operating the appliance

To switch on and increase the heat setting turn the knob clockwise. To decrease the heat setting turn the knob counter-clockwise. To switch off turn the knob to the 0.

zones and does not show that the appliance operates incorrectly.

i When a cooking zone operates, it hums for a short time. This is typical of all ceramic glass cooking

Helpful hints and tips

Cookware

-  • The bottom of the cookware must be as thick and flat as possible.
- Cookware made of enamelled steel and with aluminium or copper bottoms can cause discoloration on glass ceramic surface.

Energy saving

-  • If possible, always put the lids on the cookware.
- Put cookware on a cooking zone before you start it.

- Stop the cooking zones before the end of the cooking time to use residual heat.
- The bottom of pans and cooking zones must have the same dimension.

Examples of cooking applications

The data in the table is for guidance only.

Heat setting	Use to:	Time	Hints
1	Keep cooked foods warm	as required	Cover
1-2	Hollandaise sauce, melt: butter, chocolate, gelatine	5-25 min	Mix occasionally
1-2	Solidify: fluffy omelettes, baked eggs	10-40 min	Cook with a lid on
2-3	Simmer rice and milkbased dishes, heating up ready-cooked meals	25-50 min	Add at least twice as much liquid as rice, stir milk dishes part way through
3-4	Steam vegetables, fish, meat	20-45 min	Add a few tablespoons of liquid
4-5	Steam potatoes	20-60 min	Use max. ¼ l water for 750 g of potatoes
4-5	Cook larger quantities of food, stews and soups	60-150 min	Up to 3 l liquid plus ingredients
6-7	Gentle fry: escalope, veal cordon bleu, cutlets, rissoles, sausages, liver, roux, eggs, pancakes, doughnuts	as required	Turn halfway through
7-8	Heavy fry, hash browns, loin steaks, steaks	5-15 min	Turn halfway through
9	Boil large quantities of water, cook pasta, sear meat (goulash, pot roast), deep fry chips		

Information on acrylamides

Important! According to the newest scientific knowledge, if you brown food (specially the one which contains

starch), acrylamides can pose a health risk. Thus, we recommend that you cook at the lowest temperatures and do not brown food too much.

Care and cleaning

Clean the appliance after each use.

Always use cookware with clean bottom.

 **Warning!** Sharp objects and abrasive cleaning agents will damage the appliance.

For your safety, do **not** clean the appliance with steam blasters or high-pressure cleaners.

 Scratches or dark stains on the glass ceramic have no effect on how the appliance operates.

Removing the dirt:

1. – **Remove immediately:** melting plastic, plastic foil, and food containing sugar. Use a special glass

ceramic scraper. Put the scraper on the glass ceramic surface at an acute angle and slide the blade on the surface.

– **Stop the appliance and let it cool down** before you clean: limescale rings, water rings, fat stains, shiny metallic discolorations. Use a special cleaner for glass ceramic or stainless steel.

2. Clean the appliance with a damp cloth and some detergent.

3. At the end **rub the appliance dry with a clean cloth.**

What to do if...

Problem	Possible cause and remedy
The appliance does not operate.	<ul style="list-style-type: none">• Set the heat setting.• Examine the fuse in the electrical system of the house in the fuse box. If the fuses blow time after time, speak to an authorised electrician.
The residual heat indicator does not come on.	The cooking zone is not hot because it operated only for a short time. If the cooking zone must be hot, speak to the after sales service.

If you tried the above solutions and cannot repair the problem, speak to your dealer or the Customer Care Department. Give the data from the rating plate, three-digit-letter code for the glass ceramic (it is in the corner of the cooking surface) and an error message that comes on.

If you operated the appliance incorrectly, the servicing by a customer service technician or dealer will not be free of charge, even during the warranty period. The instructions about the customer service and conditions of guarantee are in the guarantee booklet.

Environment concerns

The symbol  on the product or on its packaging indicates that this product may not be treated as household waste. Instead it should be taken to the appropriate collection point for the recycling of electrical and electronic equipment. By ensuring this product is disposed of correctly, you will help prevent potential negative consequences for the environment and human health, which could otherwise be caused by inappropriate waste handling of this product. For more detailed

information about recycling of this product, please contact your local council, your household waste disposal service or the shop where you purchased the product.

Packaging material

 The packaging materials are friendly to the environment and can be recycled. The plastic components are identified by marking: >PE<,>PS<, etc. Discard the packaging materials as household waste at the waste disposal facilities in your municipality.

To buy accessories, consumables and spare parts at our online shop please visit:
www.zanussi.co.uk

892932524-A-012010