

**INSTRUCTIONS FOR THE USE & CARE
OF YOUR ZANUSSI COOKER**

SC9412/SC5412

ZANUSSI
USE & CARE
MANUAL

CONTENTS

Please refer to the sections in this leaflet as appropriate to the features on your particular model.

	Page
Warnings to Users	1
Installation	3
Before Use	3
Manual Control	3
Reversible Main Oven Door	4
The Control Panel	5
The Grill	6
The Main Oven	7
Timer Control	8
Cleaning	
Cleaning the hob	15
Cleaning the grill	15
Cleaning the oven	15
Stayclean Liners	
Cooking	16
Cleaning	16
Oven Cooking Chart	17
Instructions for Cooking a Complete Meal	18
Guarantee Record	20
Before Calling a Service Engineer Check List	21



IMPORTANT:
PLEASE READ THE
INSTRUCTION BOOK
BEFORE USING THIS
APPLIANCE

WARNINGS - ELECTRIC COOKERS

IT IS MOST IMPORTANT THAT THIS INSTRUCTION BOOK SHOULD BE RETAINED WITH THE APPLIANCE FOR FUTURE REFERENCE. SHOULD THE APPLIANCE BE SOLD OR TRANSFERRED TO ANOTHER OWNER, OR SHOULD YOU MOVE HOUSE AND LEAVE THE APPLIANCE, ALWAYS ENSURE THAT THE BOOK IS SUPPLIED WITH THE APPLIANCE IN ORDER THAT THE NEW OWNER CAN BE ACQUAINTED WITH THE FUNCTIONING OF THE APPLIANCE AND THE RELEVANT WARNINGS. PLEASE ENSURE THAT YOU HAVE READ THE WHOLE INSTRUCTION BOOK BEFORE USING THE APPLIANCE AND THAT YOU FOLLOW THE RECOMMENDATIONS GIVEN.

THESE WARNINGS ARE PROVIDED IN THE INTERESTS OF YOUR SAFETY. YOU MUST READ THEM CAREFULLY BEFORE INSTALLING OR USING THE APPLIANCE.

- This appliance is designed to be operated by adults only. Children should not be allowed to tamper with the controls or play with or near the product.
- Any installation work must be undertaken by a qualified electrician or competent person. The appliance must be installed according to the instructions.
- Any electrical work required to install this appliance should be carried out by a qualified electrician or competent person.
- Do not try to move the appliance by pulling the door handles. Refer to installation instructions.
- It is dangerous to alter the specifications or modify the product in any way.
- This product should be serviced by an authorised Zanussi Network Service Centre and only genuine approved spare parts should be used. Details of servicing arrangements are supplied.
- Under no circumstances should you attempt to repair the machine yourself. Repairs carried out by inexperienced persons may cause injury or more serious malfunctioning. Refer to your local Zanussi Network Service Centre. Always insist on approved spare parts. Details of servicing arrangements are supplied.
- Always ensure that all control knobs are in the 'off' position when not in use.
- Take great care when heating fats and oils as they will ignite if they become too hot.
- For hygiene and safety reasons this appliance should be kept clean at all times. A build-up of fats or other foodstuffs could result in a fire.
- Do not leave utensils containing foodstuffs e.g. fat or oil in or on the appliance in case it is inadvertently switched on.
- This product has been designed for cooking edible foodstuffs only, and must not be used for any other purposes.
- Always switch off the isolator switch at the cooker point and allow the appliance to cool before any maintenance or cleaning work is carried out.
- Only clean this appliance in accordance with the instructions given in this book.
- This appliance is heavy and care must be taken when moving it.
- Cookers and hobs become very hot with use, and retain their heat for a long period of time after use. You must

therefore take care when using the appliance, supervise children at all times and do not allow them to touch the cooker or hob surface or be in the vicinity of the appliance until it has cooled after use.

- Ensure that all packaging, both inside and (where applicable) outside the appliance is removed before the appliance is used.
- If you use a saucepan which is smaller than the heated area on the hob the handle may become hot. Ensure that you protect your hand before touching the handle.
- Never cook directly on the hob surface without a saucepan/cooking utensil. Never place plastic or any other material which may melt on the hob surface or in the oven itself.
- Always carefully lift saucepans on and off the hob. This will prevent accidents caused by spillage and will also keep cleaning to a minimum. Similarly ensure saucepans and cooking utensils are large enough to contain foods and prevent spillages and boil overs.
- Unstable or misshapen pans are dangerous and should not be used on the hotplate as unstable pans may tip or spill and cause an accident. You must follow the recommendations for saucepans given in this book.
- For ceramic hobs - Do not use the appliance if the ceramic glass is damaged. Contact your Zanussi Network Service Centre. Details supplied.
- Do not place heavy weights on the ceramic glass.

- Always use oven gloves to remove and replace the grill pan handle when grilling. Do not leave the handle in position when grilling as it will become hot.
- Always support the grill pan when it is in the withdrawn or partially withdrawn position.
- Always ensure that all vents (where fitted) are left unobstructed to ensure ventilation of the oven cavity.
- Never line any part of the appliance with aluminium foil.
- Ensure that the anti-tip oven shelves are put in place in the correct way. (See instructions).
- Take care when removing items from the oven to avoid spillages and burns.
- Always stand back from the appliance when opening the oven door(s) to allow any build up of steam or heat to release.
- Keep feet and legs clear when opening the drop down oven door (where applicable). Do not allow it to 'fall' open - support it using the door handle, until it is fully open.
- Do not place sealed cans or aerosols inside the oven. They may explode if they are heated.
- Do not stand on the appliance or on the open oven doors.
- Do not hang towels or dishcloths from the appliance or its handles. They are a safety hazard.
- Do not use this appliance if it is in contact with water. Similarly never operate it with wet hands.

Installation

Connection to the electricity supply must be made by a competent electrician, using a suitable double pole switch. Ensure that the cooker is standing level. On some models levelling feet are fitted to accommodate uneven floors.

The cable connecting the electricity supply to this appliance must have conductors of sufficiently high cross sectional area to prevent overheating and degradation.

Six square millimetres is the minimum recommended cross sectional area. The cord should also be routed away from potentially hot areas.

The appliance must be protected by a suitably rated fuse or circuit breaker. The rating of the appliance is given on the rating plate.

WARNING: THIS APPLIANCE MUST BE EARTHED

Positioning the Cooker

460 mm (18 in) models –

Allow an air gap of at least 10 mm ($\frac{3}{8}$ ") between the cooker and adjacent cabinets, walls, etc. This will also give extra space when moving the cooker for cleaning.

Some models have rollers fitted to the rear to assist when moving the cooker.

550 mm (21 in) models –

The cooker has adjustable feet to assist in positioning the cooker and is designed to slot-in between kitchen cabinets.

The space either side need only be sufficient to allow withdrawal of the cooker for servicing or cleaning.

It can be fitted with cabinets on one or both sides as well as in a corner setting. It can also be situated as a free-standing model.

Adjacent side walls which project above hob level, should be protected by heat resistant material, but in any case should not be nearer to the cooker than 75 mm (3 in). Any overhanging surface or cooker hood should not be nearer than 685 mm (27 in) above the hob.

Some models have rollers fitted to the rear to assist when moving the cooker.

To move the cooker, open the oven door and raise the cooker by lifting the inside top of the oven. Do not move the cooker by pulling the top compartment door or door handle.

Before Use

Record the model and serial numbers on the back of this leaflet.

Please ensure that any protective film and all packaging has been removed from the cooker before switching on.

Allow all elements to run for a short period to burn off any residue from the surfaces of the elements. If the odour emitted during the initial burning off is unpleasant, it may be necessary to open a window for ventilation.

During Use

This cooker has passed all the approved temperature and safety requirements. However, when using various parts of the cooker, certain areas may become hot.

Manual Control

If your cooker is fitted with a timer control and the oven indicator light does not glow when the oven control dial is turned on, it is most likely that the cooker is set for automatic cooking.

To return the cooker to manual operation:

For the Fully Automatic Timer Control (with start and stop knobs)

Turn the clock through 12 hours and push in the STOP knob. Alternatively turn the START and STOP knobs to the time set on the clock and allow the knobs to spring out. Then push in the STOP knob.

Or for the Delay Timer (with single control knob)

Turn the control knob to manual  .

This appliance complies with the Radio Interference requirements of EEC Directive 82/499/EEC.

Reversible Main Oven Door

On some models the main oven door of the cooker can be changed from left to right hand hinging, if required.

This is a reasonably simple operation if carried out in accordance with these instructions.

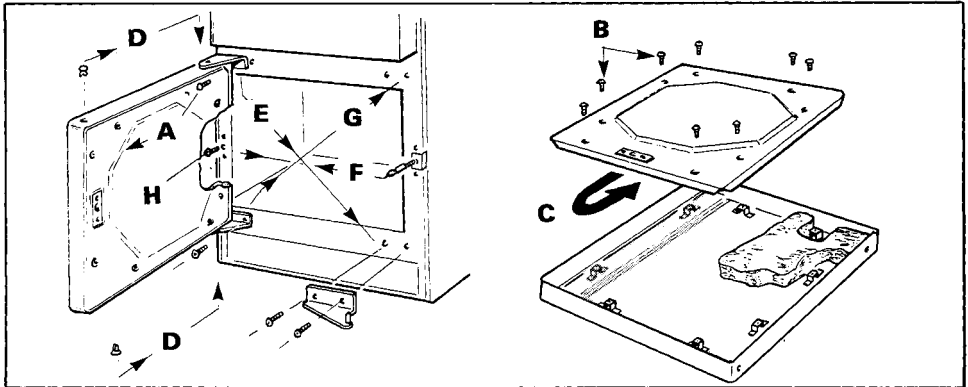

Vitreous Enamel Exterior Main Oven Door

1 pozi-drive screwdriver and 1 small adjustable spanner are needed.

(i) Open door wide and support whilst removing the two screws from the top L.H. hinge bracket. Remove hinge bracket and place to one side. Having done so, the door can now be lifted off the bottom hinge pin **(A)**.

(ii) Remove the eight screws that secure the inner door panel to the outer door panel, and remove the inner panel being careful not to disturb the insulation material **(B)**.

(iii) The inner door panel can now be turned through 180°. The door latch roller assembly will then be on the opposite end of the door (L.H.). Replace and secure inner door panel to outer door panel **(C)**.

(iv) Remove button plugs and hinge bushes (top and bottom) and transfer positions **(D)**.

(v) The upper L.H. hinge bracket (already removed) should now be transferred to the R.H. lower position **(E)**.

(vi) Remove the door catch striker and plate from R.H. side of chassis **(F)**.

Remove blanking screw from L.H. side of chassis **(H)**.

Replace blanking screws to R.H. side of chassis.

Refit door catch and plate into opposite L.H. position (Do not tighten at this stage).

(vii) The door can now be located onto the R.H. bottom hinge and held in place while the R.H. top hinge is fitted to the door and then secured to the chassis.

(The R.H. top hinge is the same hinge removed from the bottom L.H.) **(G)**.

(viii) Final adjustment: With the door still closed the door catch adjustment is automatic and can now be tightened from the side.

Inner Glass Door (where fitted)

Open inner glass door to 90° and remove by lifting up and out. Release the top hinge from the inside of the oven by removing the two fixing screws. Remove hinge pin by loosening the fixing screws, and replace into opposite end of hinge, re-tightening the screw. Remove blanking screws from holes in right hand side of oven, and using these holes

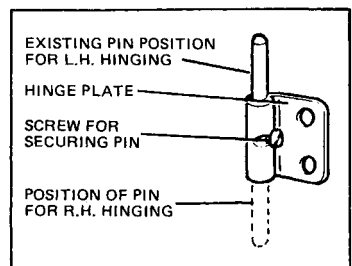







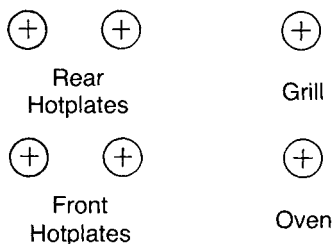

replace hinge in new position with pin upright. Repeat procedure for bottom hinge. Replace blanking screws in left hand hinge positions in oven. Remove glass door stop and replace in new position on opposite side of oven, invert glass door and rehang in new position.

THE CONTROL PANEL

The control panel knob layout may be as follows (there are no symbols on the control panel).



Some models have symbols on the control panel. Here is a guide to identify these:

-  Back left hotplate (where fitted)
-  Front left hotplate
-  Front right hotplate
-  Back right hotplate
-  Grill
-  Oven
-  Automatic timer operation - set
-  Automatic timer operation - end

THE HOB

Use of the Hob

The hotplates give rapid heat and are fast boiling. The control switches provide a very flexible control from slow simmer to fast boil. The highest number is the hottest setting. These switches have intermediate positions.

The numbers do not denote any set temperature, but after using the hob a few times no difficulty will be experienced in selecting an appropriate setting.

The control knobs can be turned in either direction to vary the heat setting; turn the control knobs to the highest setting for fast cooking.

To reduce the heat to cook more slowly or simmer, choose a lower setting although this will vary with the size and type of saucepan, the quantity and type of food and whether or not a lid is used.

Saucepans

For fastest, most economical cooking, we recommend pans with flat bases and close fitting lids. The saucepans should cover the hotplates as much as possible - up to 225 mm (9") diameter saucepans on a nominal 180 mm (7") hotplate. If using larger diameter pans, only use pans with ground bases. Damage may occur to the hob if large preserving pans or fish kettles are placed across two hotplates. Saucepans should be lifted onto and off hotplates and not slid on, since this may in time scratch the surface finish of the hob.

Never leave the hotplates on for long periods when not covered with a pan ... never place a utensil with a skirt on the hotplate e.g. a bucket ... never use an asbestos mat, or line the spillage tray with aluminium foil.

Any guidelines or recommendations given by the saucepan or cooking utensil manufacturer should be followed.

Special Frying Note:

For safety purposes when deep fat frying, fill the pan only one-third full of fat or oil. **Do not** cover the pan with a lid, and **do not** leave the pan unattended. In the unfortunate event of a fire, leave the pan where it is and switch **off** at the electricity supply. Place a damp cloth or correct fitting lid over the pan to assist in smothering the flames.

Do not use water on the fire. Leave the pan to cool for at least 30 minutes.

Do not leave the fat or oil in the frying pan on the hob to store it, in case the hob is inadvertently switched on.

To Raise the Hob

On some models the hob is hinged to allow easy cleaning of the spillage tray.

Lift the hob and secure in a raised position by means of the support arm, where fitted. Cleaning of the under side of the hob and spillage tray can now be carried out. On models where the hob is not hinged, simply slide out the spillage tray for cleaning.

The chromium plated hotplate trims may be removed for cleaning, but the hotplate spider supports should not be removed.

THE GRILL

Operation of the Grill

To operate the grill turn the grill control clockwise from the '0' position.

For grilling and toasting, the control should normally be turned to 5 for initial pre-heating of 3 minutes and then adjusted as necessary. The pre-heating may be increased to 8-12 minutes when flash grilling blue, rare or medium steaks.

The grill pan is supplied with a removable handle. To remove the handle, press the knob on the handle with the thumb, and pivot handle upwards.

Reverse this action when replacing handle.

Positioning the Grill Pan

For 460 mm (18 in) wide models - the grill pan is placed on runners in the grill compartment. For 550 mm (21 in) wide models - the grill pan is placed on the shelf, ensuring that the cut out on the underside of the handle bracket locates over the front edge of the shelf.

The runners in the grill compartment side panels provide alternative grilling positions, in addition, there is a reversible grid within the pan.

When toasting bread we suggest that the top runner position is used with the grid in either position. This is dependant on the thickness and freshness of the bread and the grid position must be adjusted to suit.

Do not line the grill pan or grid with aluminium foil. It is advisable **not** to leave food, i.e. fat or oil in the meat pan, grill pan or in a fry pan in or on the cooker, in case the cooker is inadvertently switched on.

The grill door must be left open during grilling.

The pan may be stored in this compartment with the handle removed.

THE OVEN

Use of the Main Oven

1. The oven door should be opened by pulling at the top right hand corner and closed by a gentle push.

2. The oven is supplied with specially designed non-tip shelves. To ensure that these can be pulled out to attend to food without tipping, they should be fitted in the runners with the straight rods uppermost and the forms to the back of the oven.

The runners give a variety of positions and before switching the oven ON arrange the shelves as required. (A guide to shelf positions is given in the oven cooking chart). In addition non-critical dishes can be cooked on the floor of the oven.

3. Set the oven control dial to the required temperature. The oven indicator light will glow until the oven has reached the desired temperature, and then go out. It will cycle On and Off periodically during cooking showing that the temperature is being maintained.

4. The oven is fitted with side elements. The top of the oven is the hottest and the bottom is the coolest, although there is very little temperature differential between the top and bottom.

5. Do not line any part of the oven with aluminium foil.

6. The use of oven thermometers are not recommended as they do not give accurate temperature readings and therefore can give misleading information to the user.

Inner Glass Door

Some models are fitted with an inner glass door and food can be seen during cooking without loss of heat. It is advisable to use an oven cloth when opening the inner glass door.

TIMER CONTROL (where fitted) Fully Automatic Timer

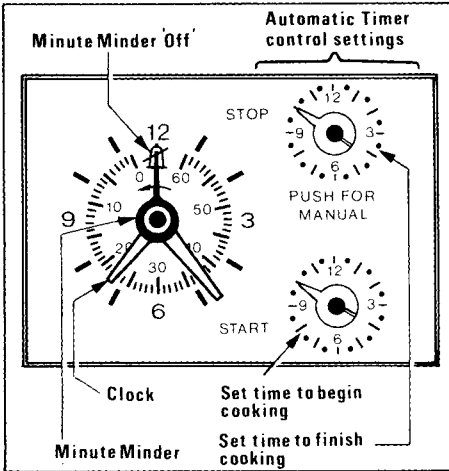

(Horizontal version illustrated but timer may be mounted vertically).

This timer will automatically switch the oven on and off at the selected 'start' and 'stop' times.

It also includes a clock and minute minder.

Clock

The clock will operate even if the automatic control is not being used. If the cooker is switched off at the wall control panel, the clock will stop. It will start as soon as the cooker is switched on again. To set the correct time of day, push in and turn the clock knob until the hands indicate the right time.

Minute Minder

The minute minder gives an audible reminder for any period of cooking up to 60 minutes. It is not part of the automatic control and is operated by the clock knob.

To set, do not push in, but turn the knob in the direction of the arrow until the pointer reaches the desired time period. At the end of the set period, a continuous buzz will be heard. To cancel, turn the clock knob to the 'Off' position (indicated by the bell symbol ).

Automatic Cooking

When the main oven is set on the timer control, the grill can be operated manually.

Auto-Timer Lights

Where fitted these are situated on the control panel.

When using the timer control for the first time it is advisable to let it operate while you are at home. The indicator lights (**see setting the timer control**) can be checked to show that it is operating correctly and you will then feel confident to leave a meal to cook automatically in the future.

Notes



A. The delay time plus the cooking period must not exceed 11½ hours.

B. Although the automatic timer control and minute minder operate within limits which ensure excellent cooking results, their accuracy is subject to a small variation in the set cooking period. The electric clock keeps accurate time.

Setting the Timer Control

Follow these simple steps:

A. TO SET THE TIMER TO SWITCH 'ON' AND 'OFF' AUTOMATICALLY

OPERATION	NOTES
1. Make sure the electricity supply is switched ON.	
2. Place food in oven.	
3. Check that the clock shows the correct time of day. Adjust if necessary.	<i>Push in and turn clock knob clock-wise or anti-clockwise as required.</i>
4. Set the STOP time.	<i>Push in and turn the STOP knob in either direction until the pointer is at the time you wish the food to STOP cooking.</i>
5. Set the START time.	<i>Push in and turn START knob in either direction until the pointer is at the time you wish the food to START cooking.</i>
6. Set the oven control to the required temperature.	<i>Both the oven indicator light and the auto end  light should be OFF. The auto set  light will be ON as an indication that the timer is set and ready to operate.</i>

When the automatic timed period starts, the **auto set**  light will switch OFF and the oven thermostat light will cycle on and off as usual.

B. TO SET THE TIMER TO SWITCH 'OFF' ONLY

Follow Points 1-3 previously, then:

4. Set the STOP time.	<i>Push in and turn the STOP knob in either direction until the pointer is at the time you wish the food to STOP cooking.</i>
5. Override the START time.	<i>Push in the start knob slightly. DO NOT TURN. Allow to spring out.</i>
6. Set the oven to the required temperature.	



To Return the Cooker to Manual Operation

Follow the steps below to ensure that after use the oven is returned to manual, otherwise it will **not** operate.

At the end of a timed cooking operation the **auto end**  light will come on.

*Ignore the **auto set**  light as this may be either on or off due to the cycle of the thermostat.*

Turn oven control to off position '0'.

*The **auto end**  light will remain on. If the **auto set**  light is on at the end of cooking it will now go out.*

Push in STOP knob.

*The **auto end**  light will go out.*

Turn the oven controls on to check that the ovens operate manually.

The thermostat lights will come on.

Turn the oven controls OFF.

No indicator lights should operate.

Note: During manual use of the oven the start clock will rotate with the time of day.

To Cancel the Timer

If there is any doubt that the timer is set for automatic cooking and the oven will not switch on manually:

1. Turn START knob to the time of day, indicated on the clock.

The knob will pop out and the oven indicator light will come ON.

2. Turn the STOP knob to the time of day, indicated on the clock.

*The knob will pop out and the oven indicator light will go OFF.
The **auto end**  light will operate.*

3. Push in STOP knob lightly.

DO NOT TURN.

4. The oven should now be operating manually.

The oven indicator light should be ON.

5. Turn oven control OFF.

Delay Timer (where fitted)

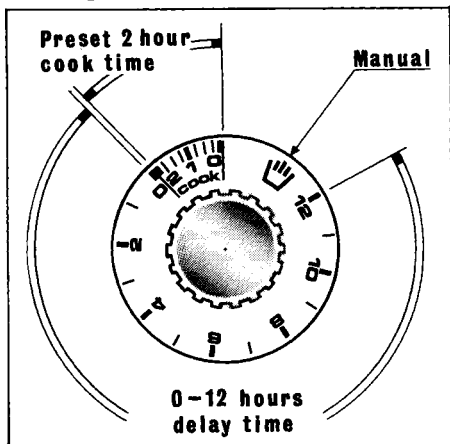

The delay timer, which is extremely easy to operate, offers the facility of a maximum of 12 hours delay with a preset 2 hour cooking period. This means that the cooker will automatically switch on after the chosen delay time, cook for 2 hours and then switch off. If a period of either **less** than 2 hours or **more** than 2 hours is required, the cooker must be switched off manually (for less than 2 hours cook) or returned to the manual position  after the 2 hour cook period, (for more than 2 hours cook).

Examples

A meal which requires 2 hour cook time

Cook Temperatures	: 190°C
Time Meal Required	: 6 pm
Cook Time	: 2 hrs
Time Oven to Switch On	: 4 pm
Time Now	: 7 am
Delay Required	: 9 hr

1. Set timer control to 9 hours on the delay period time display.
2. Set the oven control dial to 190°C. (The timer control will switch the oven on at 4 pm after the 9 hours delay period and switch off at 6 pm).
3. Turn the oven control off and return the timer control to manual.

A meal which requires **MORE** than 2 hour cook time

Cook Temperatures	: 150°C
Time Meal Required	: 1 pm
Cook Time	: 3 hrs
Time Oven to Switch On	: 10 am
Time Now	: 6 am
Delay Required	: 4 hrs

1. Set timer control to 4 hours on the delay period time display.
2. Set the oven control dial to 150°C. (The timer control will switch the oven on at 10 am after the 4 hour delay period).
3. At 12 o'clock the timer control will switch the oven off. Therefore the timer control must be returned to the manual position to allow the meal to carry on cooking for the final hour. Alternatively, reset the cook period on the timer control to 1 hour.
4. At the end of the 3 hours cook time, the oven control dial should be switched off and the timer control returned to the manual position.

A meal which requires **LESS** than 2 hour cook time

Cook Temperature	: 200°C
Time Meal Required	: 8 pm
Cook Time	: 1½ hrs
Time Oven to Switch On	: 6.30 pm
Time Now	: 2 pm
Delay Required	: 4½ hrs

1. Set timer control to 4½ hours on the delay period time display.
2. Set the oven control dial to 200°C. (The timer control will switch the oven on at 6.30 pm after the 4½ hours delay period).
3. At 8 pm the oven control dial should be switched off and the timer control returned to the manual position. (If the oven is not switched off as given in Point 3, the timer control will automatically switch off at 8.30 pm after the 2 hour preset cooking period).

A meal which requires to switch off only, i.e. no delay

Cook Temperature	: 210°C
Time Meal Required	: 2 pm
Cook Time	: 1½ hrs
Time Oven to Switch On	: Now
Time Now	: 12.30
Delay Required	: None

1. Set timer control to 1½ hours on the preset 2 hour cook time.
2. Set the oven control dial to 210°C.
(The oven will now be switched on. At 2 pm the timer control will switch the oven off).
3. Turn the oven control off and return the timer control to manual.

When a delay/cook time has been set, slight vibration may be felt through the knob. This is perfectly normal and is caused by the timer mechanism working.

TIMER CONTROL (where fitted) Fully Automatic Timer

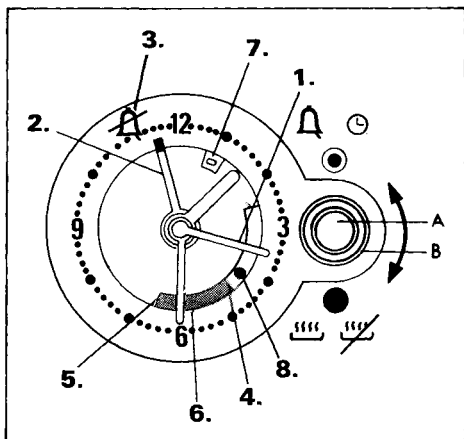

- A.** Inner section of control knob.
- B.** Outer section of control knob.
- 1.** Clock second hand.
- 2.** Hand for minute minder.
- 3.** Off position for minute minder.
- 4.** Start time indicator line.
- 5.** Stop time indicator.
- 6.** Cook time.
- 7.** Area indicating completion of automatic programme. When only this area is visible, return cooker to manual (see page 14).
- 8.** Dot indicator

This timer will automatically switch the oven on and off at the selected cook period and off at the selected 'stop' time. It also includes a clock and minute minder.

Clock

The clock will operate even if the automatic control is not being used. If the cooker is switched off at the wall control panel, the clock will stop. It will start as soon as the cooker is switched on again. To set the correct time of day, push in and turn the inner section, of the knob (**A**) in either direction until the hands indicate the right time.

Minute Minder

The minute minder gives an audible reminder for any period of cooking up to 55 minutes. It is not part of the automatic control and is operated by the inner section of the knob (**A**).

To set, do not push in, but turn the knob in either direction until the pointer reaches the desired time period. At the end of the set period, a continuous audible signal will be heard. To cancel, turn the inner section of the knob (**A**) to the 'Off' position (indicated by the bell symbol ).

Automatic Cooking

Either the main and/or second oven can be set on the timer control. However, both ovens can only be used on the timer control when the same delay period and cooking time is required for each oven. When the timer control has been set for one oven only it is not possible to use the other oven for manual cooking.

When the main oven is set on the timer control, the grill can be operated manually.

When using the timer control for the first time it is advisable to let it operate while you are at home. You will then feel confident to leave a meal to cook automatically in the future.





Notes

- A.** Maximum cooking duration is 3½ hours
- B.** The delay time plus the cooking period must not exceed 15 hours.
- C.** Although the automatic timer control and minute minder operate within limits which ensure excellent cooking results, their accuracy is subject to a small variation in the set cooking period. The electric clock keeps accurate time.

Setting the Timer Control

Follow these simple steps:

A. TO SET THE TIMER TO SWITCH 'ON' AND 'OFF' AUTOMATICALLY

OPERATION	NOTES
1. Make sure the electricity supply is switched on .	
2. Place food in oven.	
3. Check that the clock shows the correct time of day. Adjust if necessary.	<i>Push in and turn the inner section of the knob (A) clockwise or anticlockwise as required.</i>
4. Set the stop time. (This must be set first)	<i>Turn the outer section of the knob (B) clockwise towards  until the stop time indicator (5) and dot indicator are at the time you wish the food to stop cooking.</i>
5. Set the start time.	<i>Turn the outer section of the knob (B) anticlockwise towards  to bring the start time indicator line (4) to the time at which cooking is to start (The  area shows the cook time).</i>
6. Set the oven control to the required  The oven indicator light should be off .	

When the automatic timed period starts, the oven thermostat light will cycle on and off as usual and the  area will gradually disappear giving an indication of the cook time remaining.

B. TO SET THE TIMER TO SWITCH 'OFF' ONLY

Follow points 1-4 previously, then:

5. To start cooking immediately.	<i>Turn the outer section of the knob (B) anticlockwise until the start time indicator line is exactly in line with the hour hand.</i>
6. Set the oven temperature control to the required temperature, if the oven is not already on.	

CLEANING

THE ELECTRICITY SUPPLY MUST BE SWITCHED OFF BEFORE CLEANING

In the interests of your own safety, please **DO NOT** attempt to remove the timer, or any part of the timer (such as the control knobs for cleaning). Removal of the timer or any parts of the timer should be undertaken by an authorised technician.

All exterior surfaces are hard wearing, easily cleaned and impervious to all normal heat and spillage encountered during cooking. Vitreous enamel can be chipped by a hard blow and reasonable care should be exercised. The exterior surfaces including the oven doors should be cleaned using a little liquid detergent in hot water, and polished with a soft cloth.

Cleaners which contain bleach should not be used as they may dull the surface. Harsh abrasives may also affect the finish and should not be used. When removing parts of the cooker for cleaning, we recommend that they are not subjected to thermal shock, i.e. do not plunge a very hot grill pan or meat pan into warm or cold water.

Note:

Before using any proprietary oven cleaner, ensure that it is suitable for application on polished surfaces e.g. chromium, anodized aluminium, stainless steel, vitreous enamel. Certain cleaners may have an adverse effect.

Cleaning the Hob

The chromium plated hotplate trims may be removed for cleaning, but the hotplate spider supports should not be removed.

Spillage will pass through the open spiral radiant hotplate elements and drain away to the coolest part of the spillage tray below. Remove obstinate soilage with a soap impregnated steel wool pad. Non-abrasive cleaners may be used on the hob to remove obstinate marks.

Cleaning the Grill

It is essential to keep the underside of the removable vitreous enamel grill deflector absolutely clean. After grilling, thorough cleaning of the surface with a soap impregnated steel wool pad is advised.

The deflector can be removed by opening the grill compartment door without lifting the hob. Clean the grill pan in a similar manner.

When replacing the grill deflector make sure it is in position immediately above the grill element, with the front lip down.

Cleaning the Oven

If 'STAY CLEAN' panels have been fitted to this oven, instructions for cleaning these panels are given under 'Care of Stay-Clean'.

Vitreous enamel may be cleaned using normal oven cleaners.

Oven shelves if heavily soiled will wipe clean if first soaked in hot soapy water.

Inner Glass Door (where fitted)

To assist cleaning, the glass door may be removed from its hinges. The door should be opened 90 degrees to enable it to be lifted off easily. This allows the door to be completely soaked to remove obstinate soilage, alternatively clean with a warm soapy cloth. Rough abrasives should be avoided as these will scratch the surface.

Note:

If aerosol cleaners are used on any parts of the cooker the manufacturers' instructions must be followed, and it is recommended that all parts are well rinsed afterwards. **AEROSOL CLEANERS MUST NOT BE USED ON 'STAY-CLEAN' LINERS, AND MUST NOT BE ALLOWED TO COME INTO CONTACT WITH THE ELEMENTS AS THIS MAY CAUSE DAMAGE.**

STAY-CLEAN LINERS (where fitted)

Care of Stay-Clean

Cleaning of the 'Stay-Clean' surface is initiated by an inclusion of special oxides in the enamel; these are activated when the temperature of the oven is raised, and aided by oxygen, result in the soilage i.e. food splatter and grease being destroyed. The linings clean themselves during normal roasting and baking.

As cleaning may be improved by exposure to a higher temperature, it may be necessary to run the oven at maximum temperature for an hour or two per week. Manual cleaning is not advisable on 'Stay-Clean' panels. Do not use soap impregnated steel wool pads, aerosol cleaners, or any abrasive cleaners as these may damage the surface of the panels. Slight discolouration may occur in time, together with polishing of the surface finish by the oven shelves but this will not affect the cleaning properties of the panels.

In order to ensure that the liners retain their Stay-Clean properties and give years of excellent service, it may be worthwhile understanding the following points:-

Cooking

To minimise oven soilage

1. Cook at the recommended temperatures. Higher temperatures during roasting will increase soilage. Try cooking at lower temperatures for an increased length of time, you will save energy and often the joint is more tender.
2. Use minimal, if any, extra cooking oil or fat when roasting meat; potatoes only require brushing with fat before cooking. Extra fat in the oven during roasting will increase splashing and soilage.

3. It is not necessary to add water to the meat tin when roasting. The water and the fat juices from the joint create excessive splattering during cooking - even at normal temperatures as well as causing condensation.

4. Covering joints during cooking will also prevent splashings onto the interior panels; removing the covering for the last 20-30 minutes will allow extra browning if required. Some large joints and turkeys especially will benefit by this method of cooking, allowing the joint to cook through before the outside is over-browned.

5. Do use (where supplied) the trivet in the roasting tin. During roasting, the fat from the joint will be contained beneath the trivet and therefore prevent it from splattering onto the Stay-Clean liners.

Cleaning

1. The linings will clean themselves during normal roasting and baking. It is important to ensure that a build up of soilage does not occur as excessive soilage can prevent the Stay-Clean properties of the catalytic enamel from working.

2. After roasting, always check the Stay-Clean liners for soilage. If baking between roasts, this will assist in the cleaning of the liners.

3. As cleaning is improved by exposure to a higher temperature, it may be necessary to run the oven at maximum temperature for an hour or two per week or after each roast.

4. The panels which are directly next to the oven elements reach higher temperatures and clean more readily. It may be necessary to expose the roof or back panel, where fitted, to a radiant grill element to assist in burning off excessive soilage. This is not normally necessary but is worth remembering if required.

OVEN COOKING CHART

The oven temperatures are intended as a guide only. It may be necessary to increase or decrease the temperature by 10°C to suit individual preferences and requirements.

Note:

Shelf positions are counted from the bottom of the oven.

FOOD	MAIN OVEN	
	SHELF POSITIONS	COOKING TEMPERATURE °C
Biscuits	4 and 6	190-200
Bread	1 and 5	220-230
Casseroles	3	150
Cakes: Small and Queen	2 and 6	190-200
Sponges	2 and 6	190
Madeira	3	180
Rich Fruit	3	160
Christmas	2	150
Meringues	2	100
Fish	3	180-190
Fruit Pies and Crumbles	4	220
Milk Puddings	2	160
Pastry: Choux	Depending on dish	
Shortcrust		
Flaky		
Puff		
Plate Tarts	2 and 6	200
Scones	2 and 6	240
Roasting: Meat and Poultry	2	180-200

INSTRUCTIONS FOR COOKING A COMPLETE MEAL IN THE MAIN OVEN

Many people today like to cook meat at comparatively low temperatures. When these lower temperatures are used the joint is often more tender; also there is very little splashing of fat onto the oven interior during cooking. When a 'Full Meal' including a joint, roast potatoes, fruit pie and Yorkshire Pudding is required, cooking times may vary slightly according to the thickness of the joint and how 'well done' one likes the meat and potatoes etc. Slight temperature adjustment may be necessary. We hope this will prove to be a useful guide to your new cooker.

Roast Beef, Roast Potatoes, Yorkshire Pudding, Apple Pie

Preparation

Beef	1½kg (3 lb)	Arrange in the roasting tin.
Potatoes	600g (1½ lb)	Brush with melted fat or oil, sprinkle with salt and arrange around joint.
Yorkshire Pudding	250 ml (½ pt) pouring batter	Mix together 100g (4 oz) p flour and a pinch of salt. Gradually mix in a beaten egg and 250 ml (½ pt) milk until smooth.
Apple Pie	300 g (12 oz) 1 kg (2 lb)	Shortcrust pastry; Prepared fruit. Sugar to taste. Place fruit and sugar in 1 litre (2 pt) oval pie dish and cover the fruit with rolled out pastry.

Cooking

Pre-heat oven to 220°C

Arrange Beef, Potatoes and Apple Pie in the oven as follows:

Beef and Potatoes	Shelf position 1
Apple Pie	Shelf position 4

Cook at 220°C for approximately 50 minutes.

Remove pie and raise temperature to 230°C.

Yorkshire Pudding: Heat 25g (1oz) lard in a 23 cm (9 in) square tin for approximately 5 minutes on shelf position 4. Pour in batter. Cook for 35 minutes approximately.

TOTAL COOKING TIME APPROXIMATELY: 1 hour 30 minutes.

These instructions are a guide only and should be altered to suit individual requirements. If the joint is preferred very well cooked we suggest allowing an extra 15-30 minutes cooking time after removing the pie and before cooking the Yorkshire Pudding.

Peace of mind for twelve months

ZANUSSI STANDARD GUARANTEE CONDITIONS

This guarantee is in addition to your statutory and other legal rights which will not be excluded or in any way diminished by the return of this guarantee card.

We, IAZ International (UK) Ltd, undertake that if, within twelve months of the date of the purchase, this ZANUSSI appliance or any part thereof is proved to be defective by materials, we will, at our option, repair or replace the same **FREE OF ANY CHARGE** for labour, materials or carriage on condition that:

- The appliance has been correctly installed and used only on the electricity supply stated on the rating plate.
- The appliance has been used for normal domestic purposes only, and in accordance with the manufacturer's operating and maintenance instructions.
- The appliance has not been serviced, maintained, repaired, taken apart or tampered with by any person not authorised by us.
- The appliance is still in the possession of the original purchaser.

All service work under this guarantee must be undertaken by a Zanussi Network Service Centre.

Any appliance or defective part replaced shall become our property.

Exclusions

This guarantee does not cover:

Damage or calls resulting from transportation, improper use or neglect, the replacement of any light bulb or removable parts of glass or plastic.

Costs incurred for calls to put right machines improperly installed for calls to machines outside the UK and the Republic of Ireland.

Appliances found to be in use within a commercial environment, plus those which are the subject of rental agreements.

or five years

ZANUSSI 5 YEAR COVER GUARANTEE

For a once-only payment you can extend your Standard Guarantee to 5 years. All the conditions and exclusions of the Standard Guarantee apply.

Notes

1. Products supplied as 'seconds' refurbished, damaged or shop-soiled are not eligible for Zanussi 5 Year Cover.
2. The issue of a cover does NOT by virtue of our having done so, nullify the exclusions.
3. The Engineer will need to check the details of your Cover card and may make a charge for his services if it is not presented to him at the time of his call.
4. The date of purchase, or the date of initial payment (deposit) of the appliance will be deemed the date of commencement of cover.
5. Covers issued are not refundable or transferable.

Guarantee record

Appliance purchased from _____

Guarantee card no _____

Serial No _____

Your name _____

Address _____

on _____

Model No _____

**(These details may be
taken from your
Guarantee Record
Card)**

BEFORE CALLING A SERVICE ENGINEER

We strongly recommend that you carry out the following checks on your appliance before calling a Service Engineer. It may be that the problem is a simple one, which you can solve yourself without the expense of a Service call. If our Service Engineer finds that the problem is listed below you will be charged for the call whether or not the appliance is under guarantee:

Problem	Solution
The cooker does not work	<ul style="list-style-type: none">(i) check that it is switched on at the control panel.(ii) check that the main cooker fuse is working.(iii) check that the oven is set for manual operation. See instructions page.
The oven(s) indicator light does not come on and the oven(s) does not heat up	<ul style="list-style-type: none">(i) check with the instructions that the oven timer (if fitted) is set for manual cooking and is not left on an automatic setting.
The timer control does not work	<ul style="list-style-type: none">(i) check that the operating instructions are being followed, particularly when setting an automatic programme and returning the cooker to manual operation after automatic use. See instructions.
The hotplates are slow to boil	<ul style="list-style-type: none">(i) check that the recommended saucepans are being used. See instructions
The hotplates simmer inadequately	<ul style="list-style-type: none">(i) check that the recommended saucepans are being used. See instructions
The oven temperature is too high or too low	<ul style="list-style-type: none">(i) check that the temperatures recommended in this Instruction book are being followed. Be prepared to adjust the temperature up or down by 10°C to achieve the result you want.
The oven is not cooking evenly	<ul style="list-style-type: none">(i) check that the cooker is level. (see Installation instructions)
The side opening oven door will not stay open properly.	<ul style="list-style-type: none">(i) check that the oven is level. (see Installation instructions).



ZANUSSI

The Appliance of Science