

ELECTRIC COOKTOPS



USE & CARE INFORMATION

WOLF[®]



CONTENTS

Introducing Wolf Electric Cooktops	3
Safety Instructions & Precautions	4
Wolf Electric Cooktop Features	6
Wolf Electric Cooktop Use & Care	12
Wolf Troubleshooting Guide	21
Wolf Service Information	22
Wolf Warranty	23

As you read this Use & Care Information, take particular note of the CAUTION and WARNING symbols when they appear. This information is important for safe and efficient use of the Wolf equipment.

▲ CAUTION

signals a situation where minor injury or product damage may occur if you do not follow instructions.

▲ WARNING

states a hazard that may cause serious injury or death if precautions are not followed.

In addition, this Use & Care Information may signal an IMPORTANT NOTE which highlights information that is especially important.



THANK YOU

Your purchase of a Wolf electric cooktop attests to the importance you place upon the quality and performance of your cooking equipment. We understand this importance and have designed and built your cooktop with quality materials and workmanship to give you years of dependable service.

We know you are eager to start cooking, but before you do, please take some time to read this Use & Care Information. Whether you are a beginning cook or an expert chef, it will be to your benefit to familiarize yourself with the safety practices, features, operation and care recommendations of the Wolf electric cooktop.

We appreciate your choice of a Wolf Appliance product and welcome any suggestions or comments you may have. To share your opinions with us, please call 800-332-9513.

Your Wolf electric cooktop is protected by a warranty that is one of the finest in the industry. Take a moment to read the warranty statement on page 23 and refer to it should service become necessary.

CONTACT INFORMATION

**Wolf Customer
Service:
800-332-9513**

**Website:
wolfappliance.com**

SAFETY INSTRUCTIONS AND PRECAUTIONS



WHAT TO DO

- **IMPORTANT NOTE: Read all instructions before using this appliance.**
- **Read this Use & Care Information carefully before using your new cooktop** to reduce the risk of fire, electric shock or injury to persons.
- **Ensure proper installation and servicing.** This appliance must be properly installed and grounded by a qualified technician. Have the installer show you where the fuse box is located so that you know where to turn off power.
- **Wear proper apparel.** Never let loose clothing or other flammable materials come in contact with the elements while in operation. Fabric may ignite and result in personal injury.
- **Use only dry pot holders when removing pans from the cooktop.** Wet or damp pot holders on hot surfaces may result in burns from steam. Do not let pot holders touch hot heating elements.
- **Select cookware of the proper size, material and construction** for the particular type of cooking being done. This unit is equipped with one or more surface units of different size. Refer to Cookware Selection on page 19.
- **Always turn pan handles inward** so they do not extend over adjacent work areas, heating elements or edges of cooktop to reduce the risk of burns, ignition of flammable materials and spillage due to unintentional contact with pan. Do not turn handles toward the room, where they may be bumped or easily hit.
- **Always use a setting of eight bars or less on the bridge element when cooking on a griddle.** Higher settings are not needed and can damage the cooktop and cookware. Refer to Bridge-Zone Element on page 15.



WHAT **NOT TO DO**

- **Never use your cooktop to warm or heat a room.**
- **When using the cooktop DO NOT TOUCH THE GLASS SURFACE directly above or adjacent to the heating elements.** The glass surface may become hot enough to cause burns.
- **Do not leave children alone or unattended in the area where the cooktop is in use.** Never allow children to sit or stand on the appliance. Do not let children play with the cooktop.
- **Do not repair or replace any part of the appliance** unless it is specifically recommended in literature you received. All service should be referred to a Wolf authorized service center.
- **Do not use water on grease fires.** Smother the flame or use a dry chemical or foam-type extinguisher.
- **Never leave the cooktop unattended when using high heat settings.** Boilovers and greasy spillovers may smoke or ignite.
- **Do not operate the cooktop if the ceramic glass top is broken or severely pitted.** Call a Wolf authorized service center to repair the appliance.
- **Do not store flammable materials near hot components** or let grease or other flammable substances accumulate on the cooktop.
- **Do not clean the cooktop while it is still hot.** If using a damp sponge or cloth, wait until the cooktop has cooled sufficiently to prevent steam burns. Also, some cleaners give off noxious fumes when applied to hot surfaces. Refer to Cooktop Cleaning on page 18 and Cooktop Care on page 20.
- **Do not use a griddle, open roaster or fish poacher across two heating elements unless the bridge element is turned on.** This type of use without the bridge element turned on could damage or crack the glass. Refer to Bridge-Zone Element on page 15.
- **Do not block the cooling fan exhaust or intake vents.** The cooling fan automatically turns on to cool internal parts. It may continue to run even after the cooktop has been turned off.

⚠ CAUTION

DO NOT store items of interest to children above or at the back of the cooktop, as they could climb on the appliance to reach items and be injured.



FRAMED ELECTRIC COOKTOPS



Model CT15E

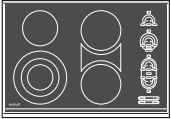

Model CT30E



Model CT36E

- Classic, platinum and carbon stainless steel trim finishes—Model CT15E in classic stainless only
- Easy-to-clean black ceramic glass surface is resistant to scratching, staining, impact and heat—translucent surface allows you to see the glow of hot elements
- High-frequency pulsation elements improve cooking performance and control
- Temperature limiter to ensure that safe operating temperature of ceramic glass is never exceeded
- Illuminated touch controls with graduated control lighting
- True Simmer setting on all elements
- Melt setting on one element
- Hot-surface indicator light in control panel
- Lock mode—cooktop can be locked so that no elements can be turned on
- Universal OFF turns all elements off
- Countdown timer with 1 to 99 minute range and adjustable sound frequency and volume
- CSA certified for US and Canada
- Two and five year residential warranty



These appliances are certified by Star-K to meet strict religious regulations in conjunction with specific instructions found on www.star-k.org.

MODEL CT15E
15" (381) Framed Electric Cooktop

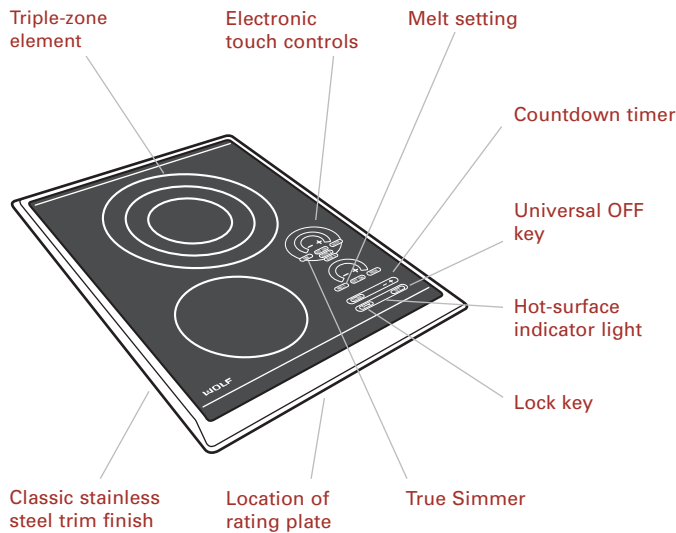



FRAMED ELECTRIC COOKTOPS

15" (381) FRAMED COOKTOP

- Two heating elements with four zones
- Triple-zone element power: 900 W/1800 W/2500 W (maximum)
- Single element power: 1200 W (maximum)
- Electric rating: 3.7 kW at 240 V AC, 2.8 kW at 208 V AC

30" (762) FRAMED COOKTOP

- Three heating elements with seven zones
- Triple-zone element power (maximum)—
Model CT30E: 900 W/1800 W/2500 W
Model CT30E-208/S: 825 W/1750 W/2300 W
- Single element power: 1200 W (maximum)
- Bridge-zone element power—(2) 1800 W single elements with 800 W bridge: 4400 W (maximum)
- Electric rating—
Model CT30E: 8.1 kW at 240 V AC, 6.1 kW at 208 V AC
Model CT30E-208/S: 7.9 kW at 208 V AC

**WOLF
WARRANTY**

Wolf products are covered by a two and five year residential warranty (exclusions apply). See warranty details at the end of this guide.

MODEL CT30E

30" (762) Framed Electric Cooktop

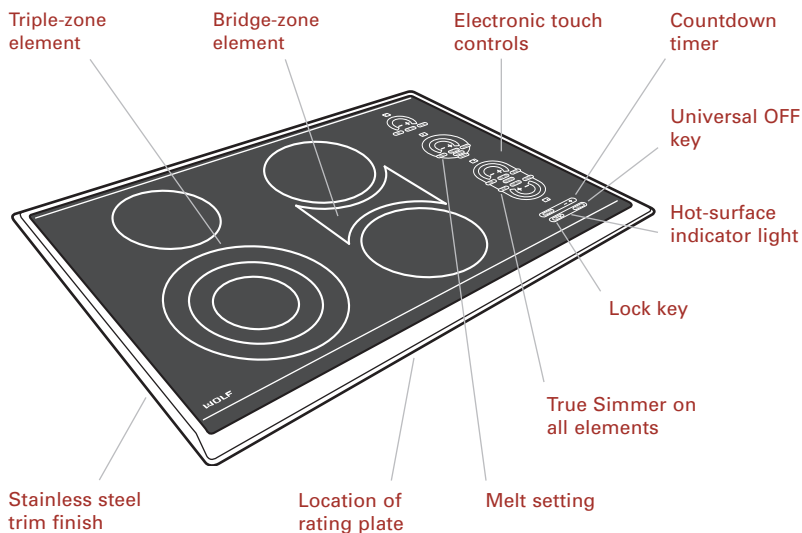

Dimensions in parentheses are in millimeters unless otherwise specified.



WOLF
WARRANTY

Wolf products are covered by a two and five year residential warranty (exclusions apply). See warranty details at the end of this guide.

FRAMED ELECTRIC COOKTOPS

36" (914) FRAMED COOKTOP

- Four heating elements with nine zones
- Triple-zone element power: 1050 W/2200 W/2700 W (maximum)
- Dual-zone element power: 700 W/2200 W (maximum)
- Single element power: 1200 W (maximum)
- Bridge-zone element power—(2) 1800 W single elements with 800 W bridge: 4400 W (maximum)
- Electric rating: 10.5 kW at 240 V AC, 7.9 kW at 208 V AC



These appliances are certified by Star-K to meet strict religious regulations in conjunction with specific instructions found on www.star-k.org.

MODEL CT36E

36" (914) Framed Electric Cooktop

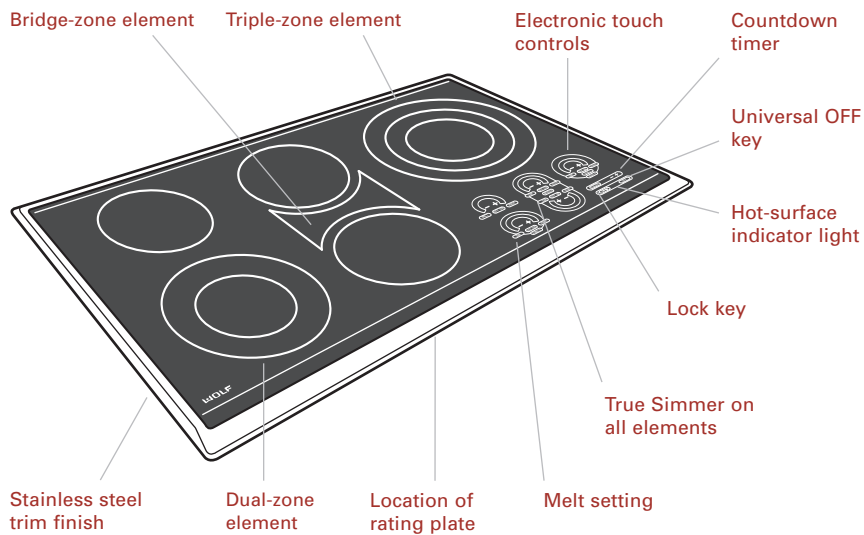

**VENTILATION** OPTIONS

IMPORTANT NOTE: It is recommended that you operate the Wolf electric cooktop with either a Wolf cooktop ventilation hood, downdraft system or Pro ventilation hood. Contact your Wolf dealer for details.

- **Cooktop Wall Hood** – 30" (762) or 36" (914) widths in classic stainless steel.
- **Cooktop Island Hood** – 42" (1067) width in classic stainless steel.
- **Downdraft Ventilation System** – 30" (762), 36" (914) or 45" (1143) widths, with top cover and control panel in classic, platinum and carbon stainless steel finishes—45" (1143) downdraft available in classic finish only. Not for use with Model CT30EU or Model CT36EU.
- **Pro Wall Hood** – 22" (559), 24" (610) or 27" (686) depths and 30" (762) to 66" (1676) widths in classic stainless steel.
- **Pro Wall Chimney Hood** – 36" (914) to 54" (1372) widths in classic stainless steel.
- **Pro Island Hood** – 36" (914) to 66" (1676) widths in classic stainless steel.
- **Pro Hood Liner** – available in widths to accommodate 36" (914) to 60" (1524) hoods.

All hoods have welded seams, sealed halogen lighting and removable, dishwasher-safe filters.



UNFRAMED ELECTRIC COOKTOPS



Model CT30EU



Model CT36EU

- Can be mounted flush with top of countertop or as a frameless installation sitting on top of the countertop surface
- Easy-to-clean black ceramic glass surface is resistant to scratching, staining, impact and heat—translucent surface allows you to see the glow of hot elements
- High-frequency pulsation elements improve cooking performance and control
- Temperature limiter to ensure that safe operating temperature of ceramic glass is never exceeded
- Illuminated touch controls with graduated control lighting
- True Simmer setting on all elements
- Melt setting on one element
- Hot-surface indicator light in control panel
- Lock mode—cooktop can be locked so that no elements can be turned on
- Universal OFF turns all elements off
- Countdown timer with 1 to 99 minute range and adjustable sound frequency and volume
- CSA certified for US and Canada
- Two and five year residential warranty



These appliances are certified by Star-K to meet strict religious regulations in conjunction with specific instructions found on www.star-k.org.

MODEL CT30EU
30" (762) Unframed Electric Cooktop

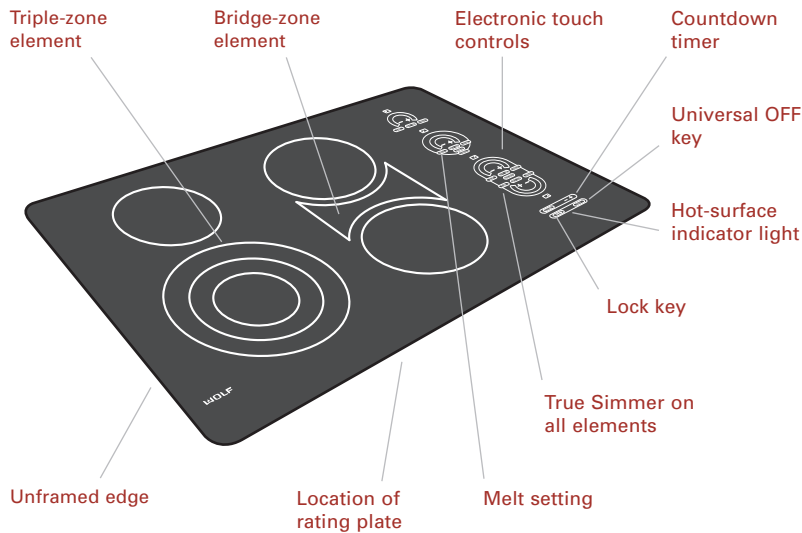



UNFRAMED ELECTRIC COOKTOPS

30" (762) UNFRAMED COOKTOP

- Three heating elements with seven zones
- Triple-zone element power: 900 W/1800 W/2500 W (maximum)
- Single element power: 1200 W (maximum)
- Bridge-zone element power—(2) 1800 W single elements with 800 W bridge: 4400 W (maximum)
- Electric rating: 8.1 kW at 240 V AC, 6.1 kW at 208 V AC

36" (914) UNFRAMED COOKTOP

- Four heating elements with nine zones
- Triple-zone element power: 1050 W/2200 W/2700 W (maximum)
- Dual-zone element power: 700 W/2200 W (maximum)
- Single element power: 1200 W (maximum)
- Bridge-zone element power—(2) 1800 W single elements with 800 W bridge: 4400 W (maximum)
- Electric rating: 10.5 kW at 240 V AC, 7.9 kW at 208 V AC

MODEL CT36EU

36" (914) Unframed Electric Cooktop

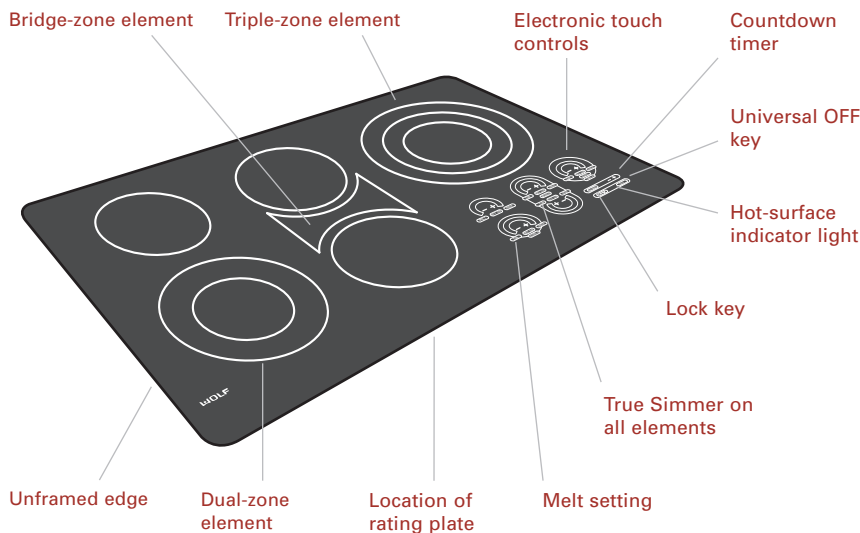

Dimensions in parentheses are in millimeters unless otherwise specified.

CONTROL OPERATION

The Wolf electric cooktop operates by using high-frequency pulsation, cycling the heating elements between zero power and full power. As the heat is increased on the control panel, the element will stay at full power for longer periods and have shorter periods of zero power.

When using the dual-zone or triple-zone elements, all sections of the element will cycle at the same rate. For safety reasons, the outer elements cannot be turned on independently from the center section.

TOUCH CONTROL PANEL

The control panel of your electric cooktop is illuminated for instant visual indication that one or more elements are in use. The control panel features touch controls with graduated control lighting. The illustrations below show the control panel of Model CT36E.

MODES OF OPERATION**LOCK MODE**

In **Lock mode**, all touch pad operations on the control panel are disabled and all heating elements are turned off. A steady glowing light within the “**key**” symbol indicates that the unit is locked. Refer to the illustration below.

- **To lock the control panel**, touch and hold the **key** for 3 seconds. The unit will beep three times and the light within the **key** symbol will illuminate. The control unit is now in **Lock mode**.
- **To unlock the control panel**, touch and hold the **key** for 3 seconds. The unit will beep twice and the light within the **key** symbol will go out. The control unit is now in **Idle mode**.

IMPORTANT NOTE: When the unit is powered up for the first time or if there has been a power outage for longer than 5 seconds, the cooktop will default to **Lock mode**.

IDLE MODE

After unlocking the control panel as described in Lock Mode, the unit enters the **Idle mode** of operation. The only valid touch pad operations are **OFF ON** for each element, the **Lock mode key** and the timer functions.

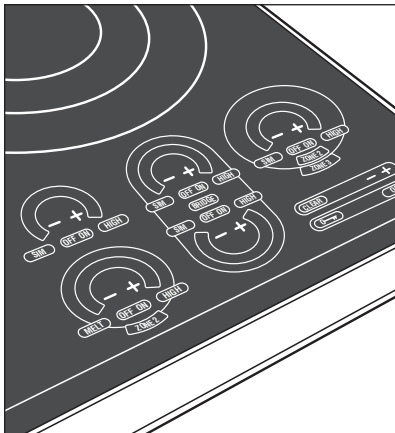

Touch control panel

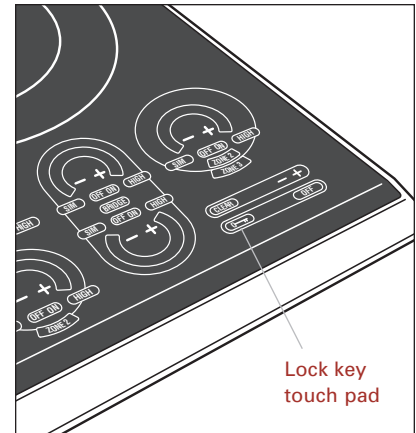

Lock mode key touch pad

**HOT-SURFACE** INDICATOR

As a safety precaution, a hot-surface indicator light will illuminate when the surface temperature of any one of the heating elements rises above 150°F (65°C). "HOT" will illuminate in the control panel. It will remain illuminated until the entire surface temperature has decreased to a safe level. Even if the cooktop controls are turned off, you are alerted that an area of the cooktop remains hot.

COOLING FAN

The electric cooktop is equipped with a cooling fan that automatically turns on to cool internal parts. The fan will turn off once internal temperatures have been lowered. During extended use, the cooling fan may continue to run even after the cooktop has been turned off until internal temperatures have been lowered.

INITIAL **START-UP**

Before operating the cooktop for the first time, please read the entire Use & Care Information.

Clean the cooktop surface as outlined in the Ceramic Glass Top cleaning section on page 18. The cooktop surface must be free of any foreign substances, especially those that could melt and permanently adhere to the glass.

During the first uses of your new electric cooktop, you may smell a slight burning odor or see light smoke. Both of these conditions are normal in new ceramic glass cooktops.

⚠ CAUTION

Make sure that the cooktop surface is clean and dry before operating.

⚠ CAUTION

Do not place hot cooking utensils directly over the control panel.

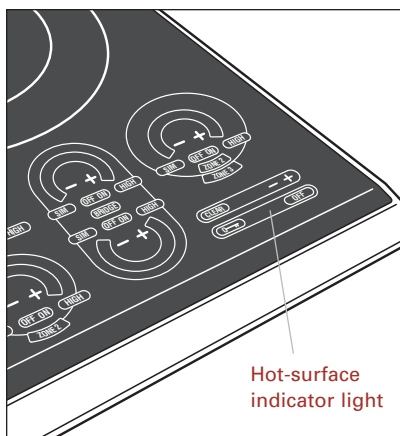

Hot-surface
indicator light

Hot-surface indicator light

Dimensions in parentheses are in millimeters unless otherwise specified.

COOKTOP OPERATION**SINGLE ELEMENT AND INNER ZONE**

To turn on a heating element, touch the **OFF ON** touch pad that corresponds to the element you wish to use. The power bar indicator graph will begin to blink and show a half-power status.

Touch one of the following symbols or touch pads of the element control while the power bar indicator graph is still blinking:

- Touch **HIGH** to set the element at the highest heat setting.
- Touch the "+" or "-" symbol to set the heat setting at half-power output.
- Touch **SIM** or **MELT** to set the element at the lowest heat setting.

To change the heat setting:

- Touch the "+" or "-" symbol to change the heat setting incrementally up or down.
- Touch **HIGH** to set the element at the highest heat setting.
- Touch **SIM** or **MELT** to set the element at the lowest heat setting.
- Touch **OFF ON** to turn the element off.

IMPORTANT NOTE: To quickly turn off all heating elements, use the universal **OFF** touch pad located in the lower right area of the control panel. Refer to the illustration below.

DUAL-ZONE ELEMENT

To turn on a dual-zone heating element, touch the **OFF ON** touch pad of the control that corresponds with the dual-zone element. Refer to the illustration on the following page.

- Set the heat setting for the inner element zone as described previously.
- Touch **ZONE 2** and the outer element zone will be set to the same heat setting as the inner zone. A light will remain on under the **ZONE 2** touch pad to indicate the outer element zone has been turned on.
- Changing the heat setting to the entire dual-zone element is the same as for a single element.
- Touch **ZONE 2** again to turn off the outer element zone. The light under the **ZONE 2** touch pad will go out.

The illustrations below show the control panel of Model CT36E.

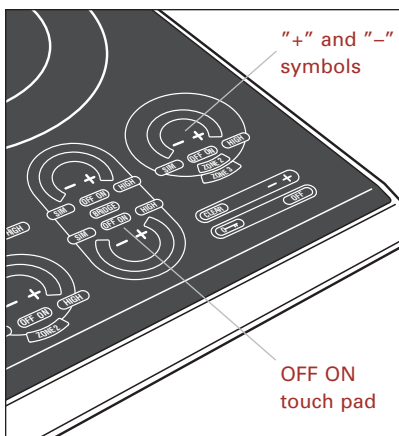
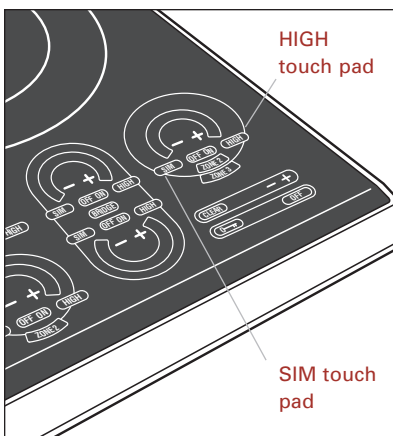
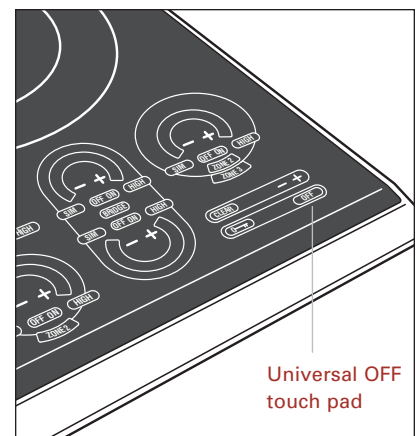
**Heating element activation****Heat settings****Universal OFF touch pad**



COOKTOP OPERATION

TRIPLE-ZONE ELEMENT

To turn on a triple-zone heating element, touch the **OFF ON** touch pad of the control that corresponds with the triple-zone element. Refer to the illustration below.

- Set the heat setting for the inner element zone as described on page 14.
- Touch **ZONE 2** and the middle element zone will be turned on to the same heat setting as the inner zone. A light will remain on under the **ZONE 2** touch pad to indicate the middle element zone is on.
- Touch **ZONE 3** and the outer element zone will be turned on to the same heat setting as the inner and middle element zones. A light will remain on under the **ZONE 3** touch pad to indicate the outer element zone is on.
- Changing the heat setting to the entire triple-zone element is the same as for a single element.

If **ZONE 3** is turned on directly, **ZONE 2** will automatically be turned on. Similarly, if all three zones are turned on, turning off **ZONE 2** will automatically turn off **ZONE 3**.

When **ZONE 3** is turned on, lights under the other two zones will dim. This is normal.

BRIDGE-ZONE ELEMENT

When activated, the bridge-zone element creates an oblong heating area for use with a griddle, open roaster or fish poacher.

To turn on the bridge-zone heating element, touch the **OFF ON** touch pad of either control that corresponds with the bridge zone element. Refer to illustration below.

- Set the heat setting for either the front or rear element as described on page 14.
- Touch **BRIDGE**. The bridge element and the element that is not turned on will both be set to the same heat setting as the first element. Lights will remain on under the front, rear and bridge element touch pads to indicate the bridge-zone elements are on.
- Changing the heat setting of the entire bridge-zone element is done the same as for a single element. All three elements maintain the same heat setting.
- Touch **BRIDGE** again to turn off the bridge element. The light under the bridge element touch pad will go out. The front and rear elements will remain at the current heat setting and will become independent of one another.

The illustrations below show the control panel of Model CT36E.

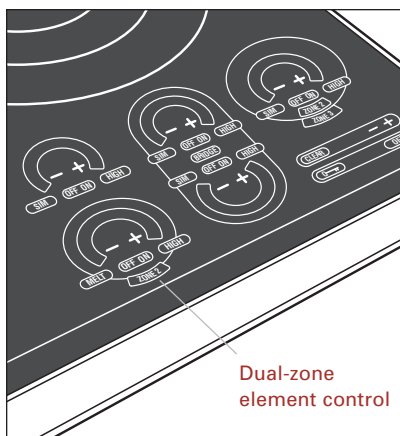

Dual-zone element

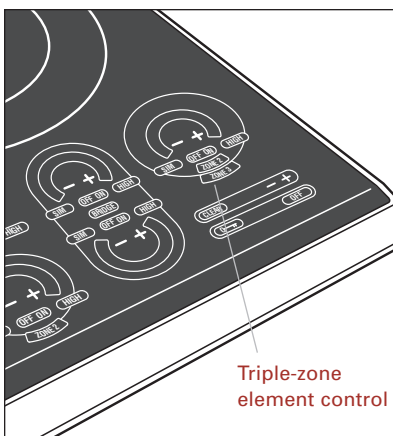

Triple-zone element

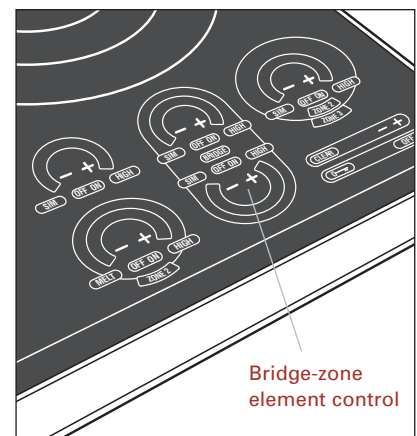

Bridge-zone element

Dimensions in parentheses are in millimeters unless otherwise specified.

COOKTOP OPERATION**BRIDGE-ZONE ELEMENT GRIDDLE USE**

Always use a setting of 8 bars or less on the bridge-zone element when cooking on a griddle. Higher settings are not needed and can damage the cooktop and cookware.

To preheat the griddle, set the bridge element at 14 bars for 5 minutes, then turn the heat down to 8 bars for cooking.

⚠ CAUTION

A griddle, open roaster, or fish poacher should not be used when the bridge-zone is off or on any of the other combination of circular heating elements.

TIMER OPERATION

The electric cooktop features a countdown timer located in the control panel. Refer to the illustration below.

The timer may be set to any one-minute increment from 1 to 99. Once set, the remaining time will be illuminated in the control panel as it counts down. The timer is available for use in any mode except **Lock mode**.

- **To turn on the timer**, touch "+" on the timer control.
- Touch and hold "+" or "-" until the desired time is reached. The timer will start 3 seconds after the last change in value.
- When the timer reaches 0, the unit will sound. The reminder will continue to sound until **CLEAR** is pressed.

The illustration below shows the control panel of Model CT36E.

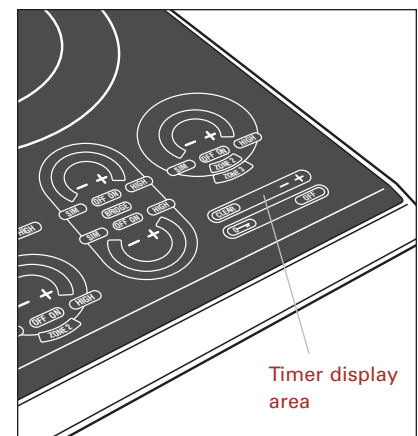

Countdown timer

**SOUND CONTROL**

The electric cooktop is equipped with the ability to change the volume and frequency, or tone, of the touch controls through the user option, activated through the timer controls.

- **To turn on user option**, the cooktop must be in **Idle mode**.
- Touch and hold **CLEAR** for 3 seconds to turn on the volume adjustment option. The three-digit display will show "Uol."
- Touch and hold **CLEAR** for more than 5 seconds to turn on the frequency adjustment option. The three-digit display will show "FRE."

Both the volume and frequency are adjusted using the "+" and "-" touch pads. One touch equals one step up or down in volume or frequency. The triple-zone element power bar indicator graph will show the current status of the volume or frequency and will change with the user's input. (1 bar = low, 8 bars = medium and 16 bars = high.)

As the volume/frequency is adjusted, the cooktop will beep with each change. The beep will represent the volume/frequency level that is currently displayed by the power bar graph.

- To exit the user option and return the cooktop to **Idle mode**, touch and hold **CLEAR** for more than 7 seconds.
- Or, if no touch pad is touched for 10 seconds, the level is then stored and the cooktop returns to **Idle mode**.

TEMPERATURE SETTING GUIDE

SETTING	USES
MELT 1 Bar	Melting, holding chocolate Melting butter Heating, holding delicate sauces Warming foods
SIMMER 2–10 Bars	Melting large quantities Simmering sauces Steaming rice
MEDIUM 12 Bars	Frying eggs Heating milk, cream sauces, gravies, puddings and cream soups Panfrying Simmering large quantities Boiling vegetables in water
MEDIUM HIGH 14–15 Bars	Sautéing Browning Braising Panfrying Maintain fast boil on large quantities Quick frying
HIGH All Bars	Boiling water Deep fat frying (to heat oil only) Heating broth soups, stocks
BRIDGE-ZONE 14 Bars, then change to 8 Bars HIGH, then reduce heat	Griddling French toast, pancakes and bacon Heating gravy (in open roaster) Poaching fish (in fish poacher)



COOKTOP CLEANING

CERAMIC GLASS TOP

Lock the cooktop before cleaning by touching and holding the **key** symbol for 3 seconds.

Clean the top surface thoroughly before operating the cooktop for the first time. Apply approximately 1 teaspoon (5 ml) of nonabrasive cleaner (such as Elco Cook Top Cleaning Creme) to the surface of the ceramic glass with a lightly dampened clean cloth. Use a second clean cloth to remove any remaining cleaner residue. Wipe the cooktop surface with a dry cloth to completely eliminate any remaining moisture.

The cooktop should be cleaned after each use. To avoid personal injury, be careful not to wipe or clean any hot areas. It will be safe to clean each element area whenever the hot-surface indicator light has gone out.

To remove heavy or burned-on spills, allow the cooktop to cool. Use the razor blade scraper provided with the cooktop to scrape off any burned-on substances. Remove any remaining residue using the cleaning method described above.

▲ CAUTION

Pitting of the ceramic glass is possible if spills with a high sugar content are left in the hot zone. Use the razor blade provided to move the spill to a cool area for cleaning after the cooktop cools.

COOKTOP FRAME (FRAMED MODELS)

For general cleaning after each use, apply a nonabrasive cleaner to the stainless steel cooktop frame and gently wipe with a clean towel or cloth. Be sure to remove any cleaner residue from the frame and ceramic glass surface before using the cooktop.

**COOKWARE SELECTION**

Cooktops with a ceramic glass surface do not require special pots and pans; however, cookware will affect overall cooking efficiency. For best results, we recommend medium- to heavy-gauge metal cookware with flat, thick and smooth bottoms and a good-fitting lid. Use the following guidelines when selecting cookware:

- Select cookware with a diameter that matches the cooking zone. When a pan is placed on the heating element, it should not extend beyond the ring around the cooking zone. Cookware for the bridge-zone element should match the cooking zone size as closely as possible. Refer to the Cookware Selection Guide.
- Look for pans that are made of materials with good heat conductivity, such as aluminum and copper. These metals are sometimes found "sandwiched" between the inner and outer layers of the pan. If present, whether visible from the outside or not, they aid in evenly conducting heat.
- Cast iron and especially glass cookware will be slower to heat. Glass cookware should only be used as recommended by the cookware manufacturer.
- Cover pans while cooking; covers improve cooking efficiency. Water boils faster, using less energy, and the kitchen stays cooler.
- Select high-sided (deep) pans rather than ones with very wide bases and low sides. High sides will minimize liquids boiling over the pan.
- Avoid pots and pans with uneven or rounded bottom surfaces. Some specialty cookware such as woks, pressure cookers, canning modules and deep fat fryers must be carefully selected to meet the guidelines above.

COOKWARE SELECTION GUIDE

Choose cookware that corresponds to the following element diameters and dimensions (bridge-zone element):

ELEMENT	POWER OUTPUT	DIAMETER
Triple-Zone Element 36" (914) cooktops	1050 W (inner)	6" (152)
	2200 W (middle)	8" (203)
	2700 W (outer)	12" (305)
Triple-Zone Element* 30" (762) and 15" (381) cooktops	900 W (inner)	5" (127)
	1800 W (middle)	7" (178)
	2500 W (outer)	10" (254)
Dual-Zone Element 36" (914) cooktops	700 W (inner)	5" (127)
	2200 W (outer)	9" (229)
(2) Single-Zone Elements 30" (762) and 36" (914) cooktops	1800 W (each)	8" (203)
Bridge-Zone Element 30" (762) and 36" (914) cooktops	800 W (bridge only)	8" x 17"
	4400 W (bridge and elements)	(203 x 432)
Single-Zone Element All electric cooktops	1200 W	6 ¹ / ₂ " (165)

**Power output differs for Model CT30-208/S. Refer to page 7 for this model.*

**COOKTOP CARE****CERAMIC GLASS TOP CARE****⚠ CAUTION**

Follow these guidelines to avoid injury and prevent permanent damage to the cooktop.

- **Do not** use the cooktop as a cutting board.
- **Do not** slide rough-bottom cookware, such as cast iron, across the glass surface. Remove any resulting marks immediately using the razor blade scraper and cleaning cream as mentioned in Cooktop Cleaning on page 18.
- **Do not** allow any item that could melt to come in contact with the hot ceramic glass surface. If such a condition occurs, remove it immediately from the hot element with a razor blade.
- **Do not** place food directly on cooktop surface when it is warm or hot.
- **Do not** operate the cooktop if the ceramic glass surface is broken. Contact a Wolf authorized service center.
- **Do not** place a trivet, wok support ring or other metal stand directly onto the cooktop surface.
- **Do not** apply chlorine bleach, ammonia or other strong chemicals or cleaners to the cooktop surface.
- **Do not** use abrasive cleaners or applicators.
- **Do not** wipe the cooktop surface with a sponge or dish cloth that may leave a film of detergent; it will cause the cooktop to discolor during the next heating cycle.

⚠ CAUTION

Do not set hot cooking utensils near the sealed outer edges of flush-mounted Models CT30EU or CT36EU. This will cause damage to the silicone seal.

MAINTENANCE

The electric cooktop is a sealed system that does not require internal maintenance. The cleaning and care information outlines the necessary maintenance for the ceramic glass surface. A Wolf authorized service center must perform all other maintenance.



TROUBLESHOOTING GUIDE

PROBLEM	PROBABLE CAUSE	CORRECTION
Cooktop does not function at all	Cooktop is in Lock mode.	Touch and hold the "key" symbol for 3 seconds to unlock the control panel.
	Cooktop is in Lock mode and the timer display shows an error code.	Errors may be cleared by pressing the "clear" button. If the error reappears, contact Wolf Customer Service.
	No electricity is being supplied to the cooktop.	Have an electrician check the house power supply.
	Fuse is blown or circuit breaker is tripped.	Have an electrician replace the fuse or reset the circuit breaker.
	Cooktop is not connected to a proper electrical circuit.	Have an electrician verify that the proper voltage is being applied to the cooktop.
Heating elements do not heat properly	Power supply connection is loose.	Have an electrician tighten connections at the electrical box.
	Cooktop is not connected to a proper electrical circuit.	Have an electrician verify that the proper voltage is being applied to the cooktop.
	Improper cookware is being used.	Select proper cookware as outlined in Cookware Selection Guide on page 19.
Heating elements cycle off when unit is set for full power	Heating element temperature limiters are temporarily shutting off element due to temperatures approaching the maximum allowable limit of the ceramic glass.	This is a normal function of the cooktop. The elements will turn on when the temperatures have cooled sufficiently.

SERVICE INFORMATIONCONTACT
INFORMATION

**Wolf Customer
Service:**
800-332-9513

Website:
wolfappliance.com

When requesting information, literature, replacement parts or service, always refer to the model and serial number of your cooktop. This information is found on the rating plate located on the underside of the cooktop. For location of the rating plate, refer to the illustration for your specific model on pages 6–11. Record the rating plate information below for future reference.

Model Number _____

Serial Number _____

Installation Date _____

Wolf Authorized Service Center and Phone

Wolf Dealer and Phone

BEFORE CALLING FOR SERVICE

Before calling your Wolf authorized service center, refer to the Troubleshooting Guide on page 21. Check the household fuse or circuit breaker to see if it has been blown or tripped and that the electrical connection to the appliance has not been disconnected. A power outage may also have caused a disruption in service.

PRODUCT REGISTRATION

Register your new Wolf product today so that we may ensure your satisfaction. You may register by one of the following options:

- 1)** Mail in the completed Wolf Product Registration Card.
- 2)** Register online at **wolfappliance.com**.
- 3)** Register by phone by calling the Wolf Customer Service Department at **800-332-9513**.

The model and serial numbers of your appliance are printed on the enclosed Wolf Product Registration Card. If you provide us with your e-mail address, we will send you exciting new product updates and recipes as they become available, along with information on special events.

The information and images in this book are the copyright property of Wolf Appliance, Inc., an affiliate of Sub-Zero, Inc. Neither this book nor any information or images contained herein may be copied or used in whole or in part without the express written permission of Wolf Appliance, Inc., an affiliate of Sub-Zero, Inc.

©Wolf Appliance, Inc. all rights reserved.

WOLF APPLIANCE PRODUCTS LIMITED WARRANTY

RESIDENTIAL USE ONLY

FULL TWO YEAR WARRANTY*

For two years from the date of original installation, your Wolf Appliance product warranty covers all parts and labor to repair or replace any part of the product that proves to be defective in materials or workmanship. All service provided by Wolf Appliance under the above warranty must be performed by a Wolf Appliance authorized service center, unless otherwise specified by Wolf Appliance. Service will be provided in the home during normal business hours.

LIMITED THIRD THROUGH FIFTH YEAR WARRANTY

From the third through fifth year from the date of original installation, Wolf Appliance will repair or replace the following parts that prove to be defective in materials or workmanship. Labor to remove and replace defective parts is not covered. Wolf Appliance recommends that you use a Wolf Appliance authorized service center to perform such service.

Gas Burners (excluding appearance), Electric Heating Elements, Blower Motors (vent hoods),
Electronic Control Boards, Magnetron Tubes and Induction Generators

LIMITED LIFETIME WARRANTY

For the life of the product, Wolf Appliance will repair or replace any outdoor gas grill body or hood that rusts through due to defective material or workmanship. Labor to remove and replace defective parts is not covered. Wolf Appliance recommends that you use a Wolf Appliance authorized service center to perform such service.

TERMS APPLICABLE TO EACH WARRANTY

The warranty applies only to products installed for normal residential use. The warranty applies only to products installed in any one of the fifty states of the United States, the District of Columbia or the ten provinces of Canada. This warranty does not cover any parts or labor to correct any defect caused by negligence, accident or improper use, maintenance, installation, service or repair.

THE REMEDIES DESCRIBED ABOVE FOR EACH WARRANTY ARE THE ONLY ONES THAT WOLF APPLIANCE, INC. WILL PROVIDE, EITHER UNDER THIS WARRANTY OR UNDER ANY WARRANTY ARISING BY OPERATION OF LAW. WOLF APPLIANCE, INC. WILL NOT BE RESPONSIBLE FOR ANY CONSEQUENTIAL OR INCIDENTAL DAMAGES ARISING FROM THE BREACH OF THIS WARRANTY OR ANY OTHER WARRANTY, WHETHER EXPRESS, IMPLIED OR STATUTORY.

Some states do not allow the exclusion or limitation of incidental or consequential damages, so the above limitation or exclusion may not apply to you. This warranty gives you specific legal rights and you may also have other legal rights that vary from state to state.

To receive parts and/or service and the name of the Wolf Appliance authorized service center nearest you, contact Wolf Appliance, Inc., P.O. Box 44848, Madison, Wisconsin 53744; check the Constant Care section of our website, wolfappliance.com, or call 800-332-9513.

*Stainless Steel (classic, platinum and carbon) doors, panels and product frames are covered by a limited 60 day parts and labor warranty for cosmetic defects





WOLF APPLIANCE, INC. P. O. BOX 44848 MADISON, WI 53744 800-332-9513 WOLFAPPLIANCE.COM

WOLF[®]

808696

8/2007



808696\$RevA