

GB

English,1

GF750TX
GF761RFX

GB

Contents

Installation, 2-5

Positioning
Gas connection
Data plate
Burner and nozzle specifications

Electrical connection,6

Description of the appliance, 7

Overall view

Start-up and use, 8-9

Practical advice on using the burners

Precautions and tips, 10

General safety
Disposal
Recycling & Disposal Information

Maintenance and care, 11

Switching the appliance off
Cleaning the appliance
Gas tap maintenance

Troubleshooting, 12

Guarantee, 13

After Sales Service, 14

Installation

GB

! Before operating your new appliance please read this instruction booklet carefully. It contains important information for safe use, installation and care of the appliance.

! Please keep these operating instructions for future reference. Pass them on to possible new owners of the appliance.

Positioning

! Keep packaging material out of the reach of children. It can become a choking or suffocation hazard (see *Precautions and tips*).

! The appliance must be installed by a qualified professional according to the instructions provided. Incorrect installation may cause harm to people and animals or may damage property.

! This unit may be installed and used only in permanently ventilated rooms in accordance with British Standard Codes Of Practice: B.S. 6172 / B.S. 5440, Par. 2 and B.S. 6891 Current Editions. The following requirements must be observed:

- The room must be equipped with an air extraction system that expels any combustion fumes. This may consist of a hood or an electric fan that automatically starts each time the appliance is switched on.

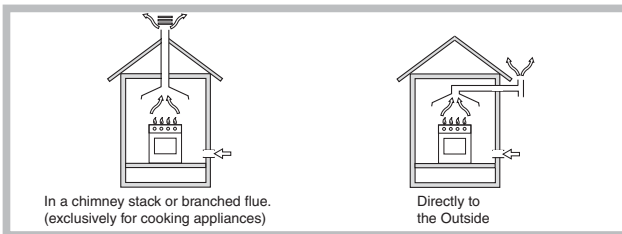

- The room must also allow proper air circulation, as air is needed for combustion to occur normally. The flow of air must not be less than 2 m³/h per kW of installed power.

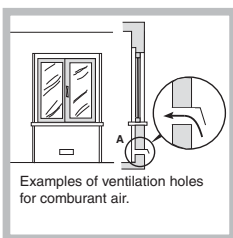

The air circulation system may take air directly from the outside by means of a pipe with an inner cross section of at least 100 cm²; the opening must not be vulnerable to any type of blockages.

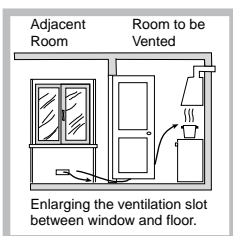

The system can also provide the air needed for combustion indirectly, i.e. from adjacent rooms fitted with air circulation tubes as described above. However, these rooms must not be communal rooms, bedrooms or rooms that may present a fire hazard.

- Liquid petroleum gas sinks to the floor as it is heavier than air. Therefore, rooms containing LPG cylinders must

also be equipped with vents to allow gas to escape in the event of a leak. As a result LPG cylinders, whether partially or completely full, must not be installed or stored in rooms or storage areas that are below ground level (cellars, etc.). It is advisable to keep only the cylinder being used in the room, positioned so that it is not subject to heat produced by external sources (ovens, fireplaces, stoves, etc.) which could raise the temperature of the cylinder above 50°C.

Fitting the appliance

Gas and mixed hobs are manufactured with type X degree protection against overheating. The following precautions must be taken when installing the hob:

- Kitchen cabinets adjacent to the appliance and taller than the top of the hob must be at least 600 mm from the edge of the hob.
- Hoods must be installed according to their relative installation instruction manuals and at a minimum distance of 650 mm from the hob.
- Place the wall cabinets adjacent to the hood at a minimum height of 420 mm from the hob (see figure).

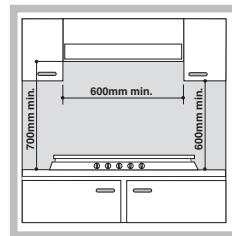

If the hob is installed beneath a wall cabinet, the latter must be situated at a minimum of 700 mm above the hob (see figure).

- The installation cavity should have the dimensions indicated in the figure. Fastening hooks are provided, allowing you to fasten the hob to tops that are between 20 and 40 mm thick. To ensure the hob is securely fastened to the top, we recommend you use all the hooks provided.

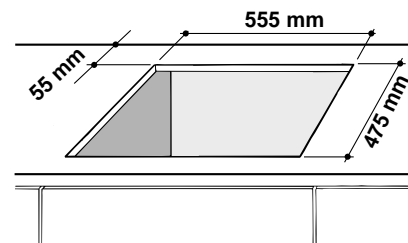

Hook fastening diagram

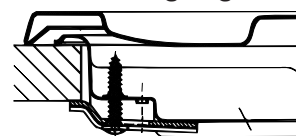

Hooking position for top H=20 mm

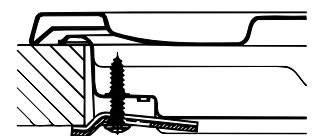

Hooking position for top H=30 mm

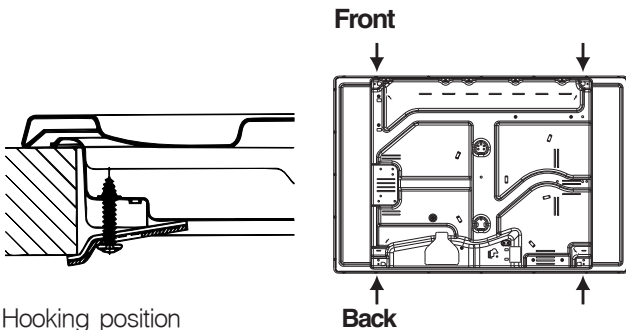

Hooking position for top **H=40 mm**

! Use the hooks contained in the “accessory pack”

- Where the hob is not installed over a built-in oven, a wooden panel must be installed as insulation. This must be placed at a minimum distance of 20 mm from the lower part of the hob.

Ventilation

To ensure adequate ventilation, the back panel of the cabinet must be removed. It is advisable to install the oven so that it rests on two strips of wood, or on a completely flat surface with an opening of at least 45 x 560 mm (see diagrams).

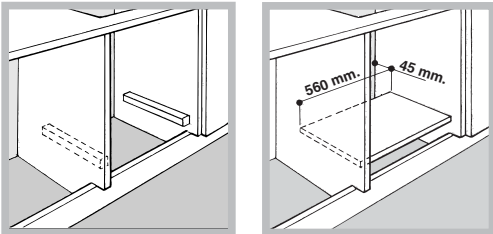

! The hob can only be installed above built-in ovens with a cooling ventilation system.

Gas connection

The appliance should be connected to the main gas supply or to a gas cylinder in compliance with current national regulations. Before carrying out the connection, make sure the cooker is compatible with the gas supply you wish to use. If this is not the case, follow the instructions indicated in the paragraph “Adapting to different types of gas.”

When using liquid gas from a cylinder, install a pressure regulator which complies with current national regulations.

! Check that the pressure of the gas supply is consistent with the values indicated in Table 1 (“Burner and nozzle specifications”). This will ensure the safe operation and longevity of your appliance while maintaining efficient energy consumption.

Connection with a rigid pipe (copper or steel)

! Connection to the gas system must be carried out in such a way as not to place any strain of any kind on the appliance.

There is an adjustable L-shaped pipe fitting on the appliance supply ramp and this is fitted with a seal in order to prevent leaks. The seal must always be replaced after rotating the pipe fitting (seal provided with appliance). The gas supply pipe fitting is a threaded 1/2 gas cylindrical male attachment.

Connecting a flexible jointless stainless steel pipe to a threaded attachment

The gas supply pipe fitting is a threaded 1/2 gas cylindrical male attachment.

These pipes must be installed so that they are never longer than 2000 mm when fully extended. Once connection has been carried out, make sure that the flexible metal pipe does not touch any moving parts and is not compressed.

! Only use pipes and seals that comply with current national regulations.

Checking the tightness of the connection

! When the installation process is complete, check the pipe fittings for leaks using a soapy solution. Never use a flame.

Adapting to different types of gas

To adapt the hob to a different type of gas other than default type (indicated on the rating plate at the base of the hob or on the packaging), the burner nozzles should be replaced as follows:

1. Remove the hob grids and slide the burners off their seats.
2. Unscrew the nozzles using a 7 mm socket spanner, and replace them with nozzles for the new type of gas (see table 1 “Burner and nozzle characteristics”).
3. Reassemble the parts following the above procedure in the reverse order.
4. Once this procedure is finished, replace the old rating sticker with one indicating the new type of gas used. Sticker are available from any of our Service Centres.

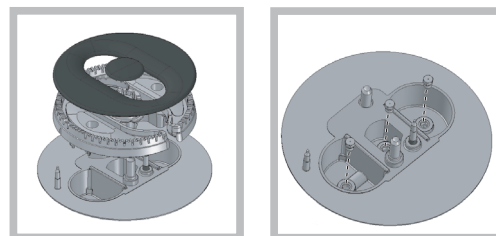

Replacing the nozzles on separate “double flame “ burners:

- remove the grids and slide the burners from their housings. The burner consists of 2 separate parts (see figure);
- unscrew the burners with a 7 mm wrench spanner. The internal burner has a nozzle, the external burner has two (of the same size). Replace the nozzle with models suited to the new type of gas (see table 1).
- replace all the components by repeating the steps in reverse order.
 - Adjusting the burners' primary air :
Does not require adjusting.

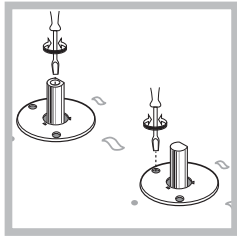



- Remove the knob and adjust the adjustment screw, which is positioned in or next to the tap pin, until the flame is small but steady.

- Having adjusted the flame to the required low setting, while the burner is alight, quickly change the position of the knob from minimum to maximum and vice versa several times, checking that the flame does not go out.
- Some appliances have a safety device (thermocouple) fitted. If the device fails to work when the burners are set to the low flame setting, increase this low flame setting using the adjusting screw.
- Once the adjustment has been made, replace the seals on the by-passes using sealing wax or a similar substance.

! If the appliance is connected to liquid gas, the regulation screw must be fastened as tightly as possible.

! Once this procedure is finished, replace the old rating sticker with one indicating the new type of gas used. Stickers are available from any of our Service Centres.

! Should the gas pressure used be different (or vary slightly) from the recommended pressure, a suitable pressure regulator must be fitted to the inlet pipe (in order to comply with current national regulations).

DATA PLATE	
Electrical connections	see data plate
 	This appliance conforms to the following European Economic Community directives: -2006/95/EEC dated 12/12/06 (Low Voltage) and subsequent amendments - 2004/108/EEC dated 15/12/04 (Electromagnetic Compatibility) and subsequent amendments - 93/68/EEC dated 22/07/93 and subsequent amendments. - 2009/142/EEC dated 30/11/09 (Gas) and subsequent amendments. - 2002/96/EC and subsequent amendments.

Burner and nozzle specifications

Table 1

Burner	Diameter (mm)	Thermal power kW (p.c.s.* Ridot.	Liquid Gas				Natural Gas			
			Thermal power kW (p.c.s.*) Nomin.	By-Pass 1/100 (mm)	Nozzle 1/100 (mm)	Flow* g/h *** **	Thermal power kW (p.c.s.*) Nomin.	Nozzle 1/100 (mm)	Flow* l/h	
Reduced Fast (RR)	100	0.70	2.60	39	80	189	186	2.60	110 (Y)	248
Semi Fast (S)	75	0.40	1.90	28	70	138	136	1.90	106	181
Auxiliary (A)	55	0.40	1.00	28	50	73	71	1.00	79	95
Triple Crown (TC)	130	1.50	3.30	61	91	240	236	3.60	145 (H1)	343
Semi-Fishburner (SP)	—	0.70	1.50	39	60	109	107	1.50	88	143
Double flame (DCDR internal)	30	0.40	0.90	28	44	65	64	0.90	74	86
Double flame (DCDR external) 2 nozzle	130	1.50	4.10	61	70	298	293	4.10	110	390
Supply Pressures	Nominal (mbar) Minimum (mbar) Maximum (mbar)					28-30 20 35	37 25 45	20 17 25		

- * At 15°C and 1013 mbar - dry gas
- ** Propane P.C.S. = 50.37 MJ/Kg
- *** Butane P.C.S. = 49.47 MJ/Kg
- Natural P.C.S. = 37.78 MJ/m³

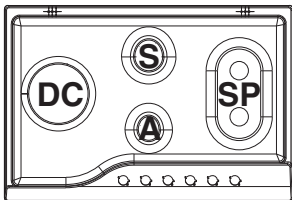

GF761RFX

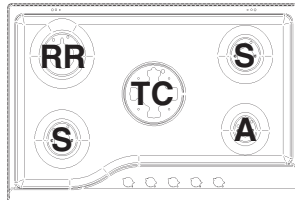

GF750TX

! The hob can only be installed above built-in ovens with a cooling ventilation system.

Electrical Connection

GB

Power supply voltage and frequency: 220-240V a.c. 50/60Hz.

! The supply cable must be positioned so that it never reaches at any point a temperature 50°C higher than the room temperature. The cable must be routed away from the rear vents. Should you require it, you may use a longer cable, however, you must ensure that the cable supplied with the appliance is replaced by one of the same specifications in accordance with current standards and legislation.

Your appliance is supplied with a 13 amp fused plug that can be plugged into a 13 amp socket for immediate use. Before using the appliance please read the instructions below.

! THIS APPLIANCE MUST BE EARTHED. THE FOLLOWING OPERATIONS SHOULD BE CARRIED OUT BY A QUALIFIED ELECTRICIAN.

Replacing the fuse

When replacing a faulty fuse, a 13 amp ASTA approved fuse to BS 1362 should always be used, and the fuse cover re-fitted. If the fuse cover is lost, the plug must not be used until a replacement is obtained.

Replacement fuse covers

If a replacement fuse cover is fitted, it must be of the correct colour as indicated by the coloured marking or the colour that is embossed in words on the base of the plug. Replacements can be obtained directly from your nearest Service Depot.

Removing the plug

If your appliance has a non-rewireable moulded plug and you should wish to remove it to add a cable extension or to re-route the mains cable through partitions, units etc., please ensure that either:

- the plug is replaced by a fused 13 amp re-wireable plug bearing the BSI mark of approval.
- or:
- the mains cable is wired directly into a 13 amp cable outlet, controlled by a switch, (in compliance with BS 5733) which is accessible without moving the appliance.

Please note: for appliances with a rating greater than 13 amp (eg: electric hob, double ovens and freestanding electric cookers etc.) the mains cable must be wired into a cooker output point with a

rating of 45 amp. In this case the cable is not supplied.

Disposing of the plug

Ensure that before disposing of the plug itself, you make the pins unusable so that it cannot be accidentally inserted into a socket. Instructions for connecting cable to an alternative plug:

! The wires in the mains lead are coloured in accordance with the following code:

Green & Yellow - Earth
Blue - Neutral
Brown - Live

If the colours of the wires in the mains lead do not correspond with the coloured markings identifying the terminals in your plug, proceed as follows:

Connect Green & Yellow wire to terminal marked "E" or \perp or coloured Green or Green & Yellow.

Connect Brown wire to terminal marked "L" or coloured Red.

Connect Blue wire to terminal marked "N" or coloured Black.

If a 13 amp plug (BS 1363) is used it must be fitted with a 13 amp fuse. A 15 amp plug must be protected by a 15 amp fuse, either in the plug or adaptor or at the distribution board. If you are in any doubt about the electrical supply to your machine, consult a qualified electrician before use.

How to connect an alternative plug

The wires in this mains lead are coloured in accordance with the following code:

BLUE "NEUTRAL" ("N")
BROWN "LIVE" ("L")
GREEN AND YELLOW "EARTH" ("E")

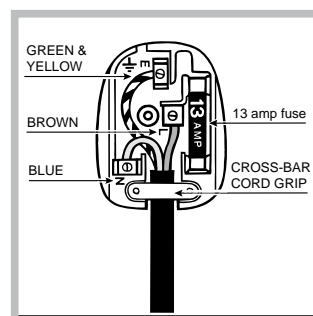

Disposing of the appliance

When disposing of the appliance please remove the plug by cutting the mains cable as close as possible to the plug body and dispose of it as described above.

Overall view

GB

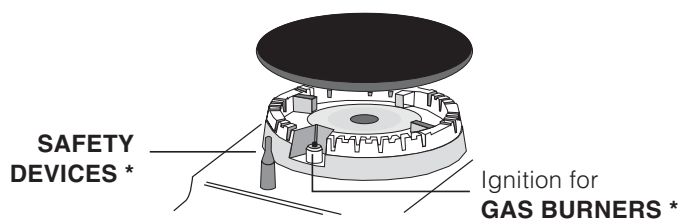
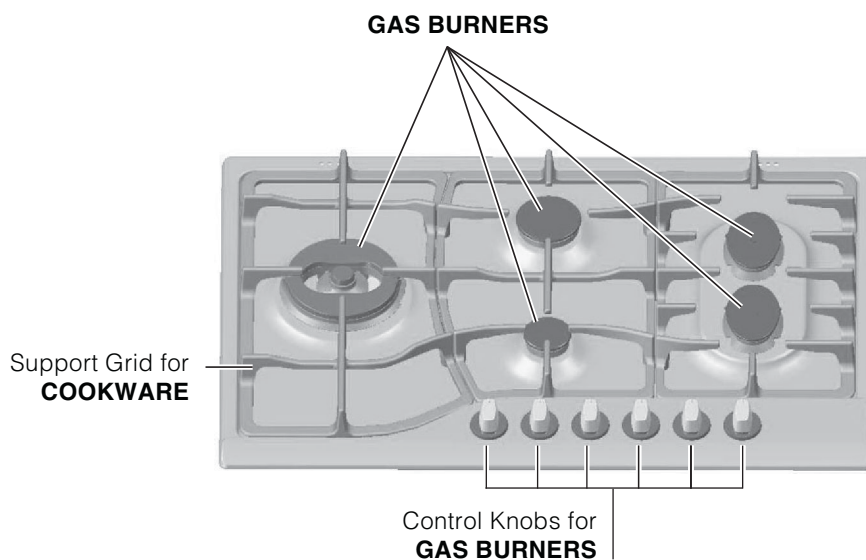

- **GAS BURNERS** differ in size and power. Use the diameter of the cookware to choose the most appropriate burner to cook with.
- Control Knobs for **GAS BURNERS** adjust the power or the size of the flame.

- **GAS BURNER ignition*** enables a specific burner to be lit automatically.
- **SAFETY DEVICE*** stops the gas flow if the flame is accidentally extinguished.

* Only available on certain models.

Start-up and use

GB

! The position of the corresponding gas burner or electric hotplate* is shown on every knob.

Gas burners

Each burner can be adjusted to one of the following settings using the corresponding control knob:

- Off
- ☹ Maximum
- ☹ Minimum

To light one of the burners, hold a lit match or lighter near the burner and, at the same time, press down and turn the corresponding knob anti-clockwise to the maximum setting.

Since the burner is fitted with a safety device, the knob should be pressed for approximately 2-3 seconds to allow the automatic device keeping the flame alight to heat up.

When using models with an ignition button, light the desired burner pressing down the corresponding knob as far as possible and turning it anticlockwise towards the maximum setting.

! If a flame is accidentally extinguished, turn off the control knob and wait for at least 1 minute before trying to relight it.

To switch off the burner, turn the knob in a clockwise direction until it stops (when reaches the “•” position).

The “separate double flame” burner*

This burner consists of two concentric burners which can operate either together or separately. Use of the double flame on the maximum setting gives a very high power which reduces cooking times with respect to conventional burners.

Moreover the double flame crown provides a more uniform distribution of heat on the bottom of the pan, when using both burners on minimum.

To ensure that the double-flame burner is used to its full potential, never set the inside ring to minimum and the outside ring to maximum at the same time.

Pots and pans of all sizes can be used. In the case of the smaller pots and pans we recommend the use of only the internal burner.

There is a separate control knob for each of the “separate double flame” burners.

The knob marked by the symbol ☹ operates the external burner;

The knob marked by the symbol ☹ operates the internal burner.

To turn on one of the rings, press the relative knob in all the way and turn it anti-clockwise to the high

setting ☹. The burner is fitted with an electronic igniter that automatically starts when the knob is pressed in.

Since the burner is equipped with a safety device, after lighting the burner keep the knob pressed in for about 2-3 seconds to allow the device which keeps the flame lit automatically to heat up.

The selected burner can be regulated using the corresponding knob, as follows:

- Off
- ☹ Maximum
- ☹ Minimum

To switch off the burner, turn the knob in a clockwise direction until it stops (when reaches the “•” position).

Practical advice on using the burners

To ensure the burners operate efficiently:

- Use appropriate cookware for each burner (see table) so that the flames do not extend beyond the bottom of the cookware.
- Always use cookware with a flat base and a cover.
- When the contents of the pan reach boiling point, turn the knob to minimum.

Burner	∅ Cookware diameter (cm)
Reduced Rapid (RR)	24 - 26
Semi-Rapid (S)	16 - 20
Auxilliary (A)	10 - 14
Half-Fishburner (SP)	16 - 20
Triple Crown (TC)	24 - 26
Double flame (DCDR internal)	10 - 14
Double flame (DCDR external)	26 - 28

! On the models supplied with a reducer shelf, remember that this should be used only for the Double flame internal (DCDR internal) burner when you use casserole dishes with a diameter under 12 cm. To identify the type of burner, refer to the designs in the section entitled, "Burner and Nozzle Specifications".

* Only available on certain models.

Practical Advice on Using the Half Fish-Kettle Burner *

The two "Half Fish-Kettle" burners, are elliptic in form and can be turned up to 90°. This makes the cooktop more flexible in terms of how it can be used.

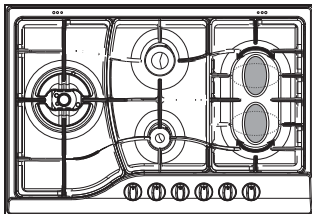

To turn the two burners 90°, proceed as follows:

- Make sure that the burners are cool;
- Lift the burner completely out of its housing;
- Replace it in its housing in the position desired;
- Make sure that the burners are positioned correctly before use.

In addition, the two burners can be used in tandem or separately with cookware of different shapes and sizes:

- Double burner for a fish-kettle or oval cookware (Fig.A).
- Double burner for a griddle or rectangular/square cookware with minimum dimensions of 28x28 cm (Fig.B)
- Single burner for medium size cookware (diameter of 16-20 cm) (Fig.C).
- **NEVER use the double burner in the configuration represented in figure D.**

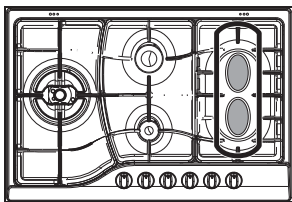

Fig. A

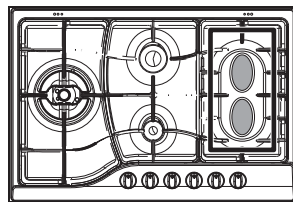

Fig. B

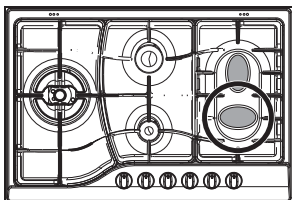

Fig. C

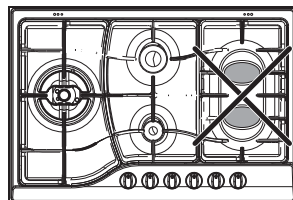

Fig. D

* Only available on certain models.

Precautions and tips

GB

! This appliance has been designed and manufactured in compliance with international safety standards. The following warnings are provided for safety reasons and must be read carefully.

General safety

- **This is a class 3 built-in appliance.**
- **Gas appliances require regular air exchange to maintain efficient operation. When installing the hob, follow the instructions provided in the paragraph on “Positioning” the appliance.**
- **These instructions are only valid for the countries whose symbols appear in the manual and on the serial number plate.**
- The appliance was designed for domestic use inside the home and is not intended for commercial or industrial use.
- The appliance must not be installed outdoors, even in covered areas. It is extremely dangerous to leave the appliance exposed to rain and storms.
- Do not touch the appliance with bare feet or with wet or damp hands and feet.
- **The appliance must be used by adults only for the preparation of food, in accordance with the instructions outlined in this booklet. Any other use of the appliance (e.g. for heating the room) constitutes improper use and is dangerous. The manufacturer may not be held liable for any damage resulting from improper, incorrect and unreasonable use of the appliance.**
- Ensure that the power supply cables of other electrical appliances do not come into contact with the hot parts of the oven.
- The openings used for ventilation and dispersion of heat must never be covered.
- Always make sure the knobs are in the “●”/“○” position when the appliance is not in use.
- When unplugging the appliance always pull the plug from the mains socket, do not pull on the cable.
- Never carry out any cleaning or maintenance work without having detached the plug from the mains.
- In case of malfunction, under no circumstances should you attempt to repair the appliance yourself. Repairs carried out by inexperienced persons may cause injury or further malfunctioning of the appliance. Contact a Service Centre (see *Assistance*).
- Always make sure that pan handles are turned towards the centre of the hob in order to avoid accidental burns.
- Do not close the glass cover (if present) when the gas burners or electric hotplates are still hot.
- Do not leave the electric hotplate switched on without a pan placed on it.
- Do not use unstable or deformed pans.
- **Remove any liquid from the lid before opening it.**

- Prevent children and the disabled from coming into contact or having access at the ceramic glass cooking surface (if present) immediately before and after use, as the cooking surface will remain hot for at least a half hour after being turned off;
- Contact service centers authorized by the manufacturer in the event the ceramic glass cooking surface breaks.
- It is recommended that you follow the guidelines below:
- Disconnect the appliance from the electrical supply in the event the ceramic glass cooking surface breaks.
- The appliance should not be operated by people (including children) with reduced physical, sensory or mental capacities, by inexperienced individuals or by anyone who is not familiar with the product. These individuals should, at the very least, be supervised by someone who assumes responsibility for their safety or receive preliminary instructions relating to the operation of the appliance.
- Do not let children play with the appliance.
- **The appliance is not intended to be operated by means of an external timer or separate remote-control system.**

Disposal

- When disposing of packaging material: observe local legislation so that the packaging may be reused.
 - The European Directive 2002/96/EC on Waste Electrical and Electronic Equipment (WEEE), requires that old household electrical appliances must not be disposed of in the normal unsorted municipal waste stream. Old appliances must be collected separately in order to optimise the recovery and recycling of the materials they contain and reduce the impact on human health and the environment. The crossed out “wheeled bin” symbol on the product reminds you of your obligation, that when you dispose of the appliance it must be separately collected.
- Consumers may take their old appliance to public waste collection areas, other communal collection areas, or if national legislation allows return it to a retailer when purchasing a similar new product.
- All major household appliance manufacturers are active in the creation of systems to manage the collection and disposal of old appliances.



Recycling & Disposal Information

As part of Hotpoint's continued commitment to helping the environment, Hotpoint reserves the right to use quality recycled components to keep down customer costs and minimise material wastage.

Please dispose of packaging and old appliances carefully. To minimise risk of injury to children, remove the door, plug and cut mains cable off flush with the appliance. Dispose of these parts separately to ensure that the appliance can no longer be plugged into a mains socket, and the door cannot be locked shut.

Switching the appliance off

Disconnect your appliance from the electricity supply before carrying out any work on it.

Cleaning the appliance

! Do not use abrasive or corrosive detergents such as stain removers, anti-rust products, powder detergents or sponges with abrasive surfaces: these may scratch the surface beyond repair.

! Never use steam cleaners or pressure cleaners on the appliance.

- It is usually enough to wash the hob with a damp sponge and dry it with absorbent kitchen roll.
- The removable parts of the burners should be washed frequently with warm water and soap and any burnt-on substances removed.
- For hobs which light automatically, the terminal part of the electronic instant lighting devices should be cleaned frequently and the gas outlet holes should be checked for blockages.
- Stainless steel can be marked by hard water that has been left on the surface for a long time, or by aggressive detergents containing phosphorus. After cleaning, rinse and dry any remaining drops of water.

Gas tap maintenance

Over time, the taps may become jammed or difficult to turn. If this happens, the tap must be replaced.

! This procedure must be performed by a qualified technician authorised by the manufacturer.

Troubleshooting

GB

It may happen that the appliance does not function properly or at all. Before calling the service centre for assistance, check if anything can be done. First, check to see that there are no interruptions in the gas and electrical supplies, and, in particular, that the gas valves for the mains are open.

Problem

The burner does not light or the flame is not even around the burner.

Possible causes/Solution

- The gas holes on the burner are clogged.
- All the movable parts that make up the burner are mounted correctly.
- There are draughts near the appliance.

The flame dies in models with a safety device.

- You pressed the knob all the way in.
- You keep the knob pressed in long enough to activate the safety device.
- The gas holes are not blocked in the area corresponding to the safety device.

The burner does not remain lit when set to minimum.

- The gas holes are not blocked.
- There are no draughts near the appliance.
- The minimum setting has been adjusted properly.

The cookware is unstable.

- The bottom of the cookware is perfectly flat.
- The cookware is positioned correctly at the centre of the burner.
- The pan support grids have been positioned correctly.

If, despite all these checks, the hob does not function properly and the problem persists, call the nearest Customer Service Centre. Please have the following information handy:

- The appliance model (Mod.).
- The serial number (S/N).

This information can be found on the data plate located on the appliance and/or on the packaging.

! Never use unauthorised technicians and never accept replacement parts which are not original.



Guarantee

12 months Parts and Labour Guarantee

Your appliance has the benefit of our manufacturer's guarantee, which covers the cost of breakdown repairs for twelve months from the date of purchase.

This gives you the reassurance that if, within that time, your appliance is proven to be defective because of either workmanship or materials, we will, at our discretion, either repair or replace the appliance at no cost to you.

This guarantee is subject to the following conditions:

- The appliance has been installed and operated correctly and in accordance with our operating and maintenance instructions.
- The appliance is used only on the electricity or gas supply printed on the rating plate.
- The appliance has been used for normal domestic purposes only.
- The appliance has not been altered, serviced, maintained, dismantled, or otherwise interfered with by any person not authorised by us.
- Any repair work must be undertaken by us or our appointed agent.
- Any parts removed during repair work or any appliance that is replaced become our property.
- The appliance is used in the United Kingdom or Republic of Ireland.

The guarantee does not cover:

- Damage resulting from transportation, improper use, neglect or interference or as a result of improper installation.
- Replacement of any consumable item or accessory. These included but not limited to: plugs, cables, batteries, light bulbs, fluorescent tubes and starters, covers and filters.
- Replacement of any removable parts made of glass or plastic.

THIS GUARANTEE WILL NOT APPLY IF THE APPLIANCE HAS BEEN USED IN COMMERCIAL OR NON-DOMESTIC PREMISES.

5 Year Parts Guarantee

Hotpoint also offers you a free 5 year parts guarantee. This additional guarantee is conditional on you registering your appliance with us and the parts being fitted by one of our authorised engineers. There will be a charge for our engineer's time. To activate the extra parts warranty on your appliance, simply call our registration line on **08448 24 24 24 (Republic of Ireland 01 230 0800)**

Extended Guarantees

We offer a selection of protection plans that enable you to fully cover yourself against the expense of repair bills for the life of your policy. To find the ideal plan for you please call our advice line on **08448 226 226 (Republic of Ireland 01 230 0233)**.

Free Helpdesk Service

We have a dedicated team who can provide free advice and assistance with your appliance if you experience any technical difficulties within the first 90 days of ownership. Simply call our Hotpoint Service Hotline on **08448 224 224 (Republic of Ireland 0818 313 413)** for telephone assistance, or, where necessary, to arrange for an engineer to call.



After Sales Service

No one is better placed to care for your Hotpoint appliance during the course of its working life than us – the manufacturer.

Essential Contact Information

Hotpoint Service

We are the largest service team in the country offering you access to 400 skilled telephone advisors and 1000 fully qualified engineers on call to ensure you receive fast, reliable, local service.

UK: 08448 224 224
Republic of Ireland: 0818 313 413
www.hotpointservice.co.uk

Please note: Our advisors will require the following information:

Model number:

Serial number:

Parts and Accessories

We supply a full range of genuine replacement parts as well as accessory products that protect and hygienically clean your appliance to keep it looking good and functioning efficiently throughout its life.

UK: 08448 225 225
Republic of Ireland: 0818 313 413
www.hotpointservice.co.uk

Appliance Registration

We want to give you additional benefits of Hotpoint ownership. To activate your free 5 year parts guarantee you must register your appliance with us.

UK: 08448 24 24 24
Republic of Ireland: 01 230 0800
www.hotpointservice.co.uk

Indesit Company UK Ltd. Morley Way, Peterborough, PE2 9JB
Indesit Company Unit 49 Airways Industrial Estate, Dublin 17

Recycling and Disposal Information

As part of Hotpoint's continued commitment to helping the environment, Hotpoint reserves the right to use quality, recycled components to keep down customer costs and minimise material wastage.

Please dispose of packaging and old appliances carefully. To minimise the risk of injury to children, remove the door, plug, and cut the mains cable off flush with the appliance. Dispose of these parts separately to ensure that the appliance can no longer be plugged into mains socket, and the door cannot be locked shut.

GB