

TRICITY BENDIX

*OPERATING & INSTALLATION
INSTRUCTIONS*

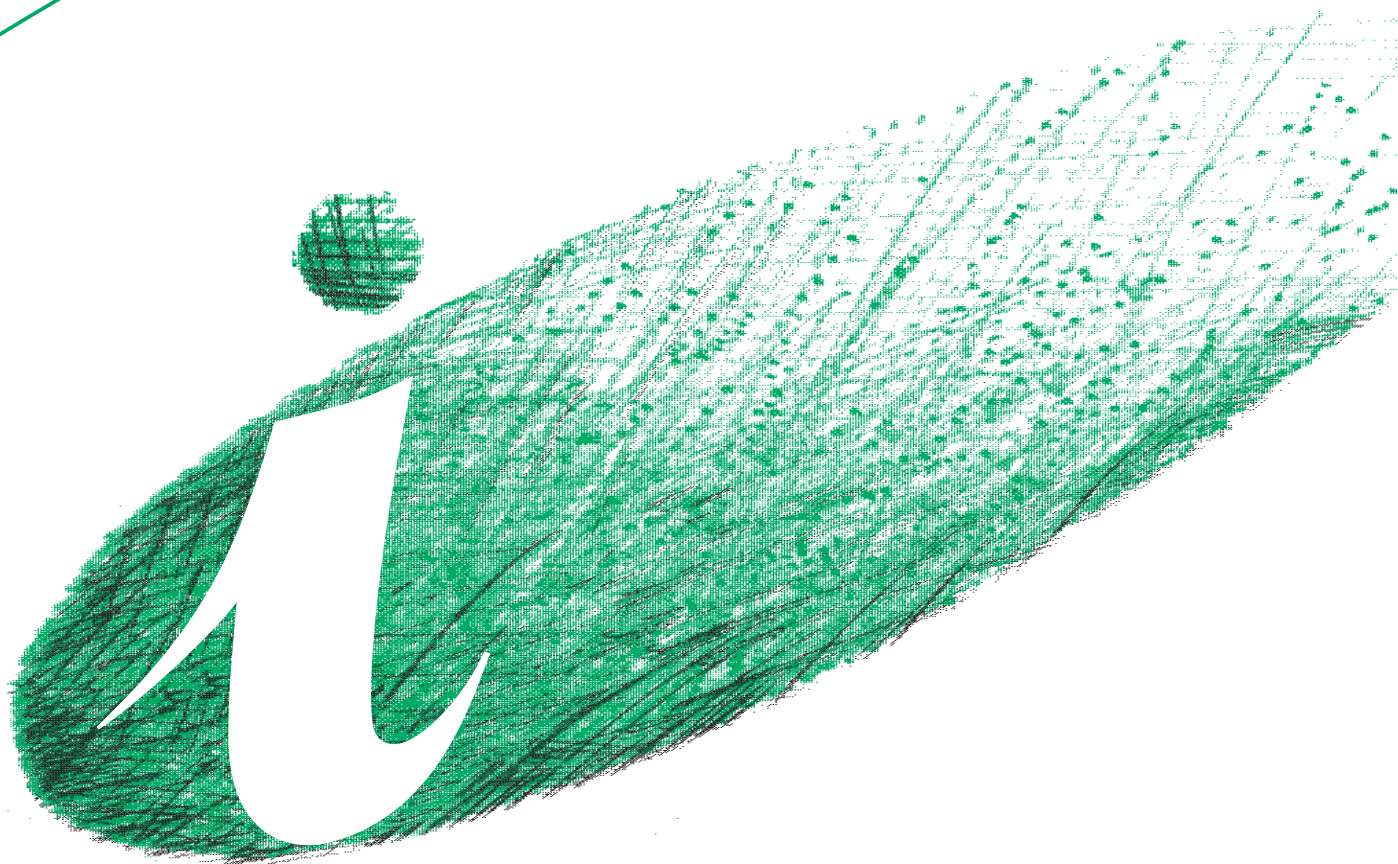

SLIP IN ELECTRIC COOKER

SE323

PLEASE READ THIS INSTRUCTION BOOKLET BEFORE USING THE APPLIANCE

TECHNICAL DETAILS

MODEL NO. SE 323

Voltage:	230-240 Volts AC 50Hz
Wattage:	9.3-10.2kW
Height:	900mm
Width:	500mm
Depth:	600mm
Weight:	55 kg

 This appliance complies with: European Council Directive 73/23/EEC.
EMC Directive 89/336/EEC.
CE Marking Directive 93/68/EEC

CONTENTS

Technical Details	2
Contents	3
Preface	5
Safety	6
Before Installation	6
During Operation	6
After Use	7
General	7
Introduction	8
Rating Plate	8
Installation	8
General Notes on Using Your Appliance	9
About Condensation and Steam	9
Oven Indicator Neon	9
Grill and Oven Furniture	9
Getting to Know Your Appliance	10
The Control Panel	10
The Electronic Minute Minder	11
The Sealed Hotplates	14
Recommended Saucepans	14
Hints and Tips	14
Deep Fat Frying	15
Preserving	15
The Grill	16
Selecting the Grill	16
Things to Note	16
The Grill Pan and Handle	16
Hints and Tips	17
Grilling Chart	17
The Fan Oven	18
Uses of the Fan Oven	18
Selecting the Fan Oven	18
Things to Note	18
To Fit the Fan Oven Shelves	18
Hints and Tips	19

CONTENTS

Oven Cooking Chart	20
Oven Roasting Chart	21
Defrost Feature	22
Uses of Defrost Feature	22
Selecting Defrost	22
Things to Note	22
Hints and Tips	22
Care and Cleaning	23
Cleaning Materials	23
Cleaning the Handles	23
Cleaning the Outside of the Appliance	23
Cleaning the Sealed Hotplates and Hotplate Trims	23
Things to Note	23
Cleaning the Grill and Oven Furniture	24
Cleaning Inside the Grill and Oven Compartments	24
Care of Stayclean Surfaces	24
Hints and Tips	24
Cleaning between the Outer and Inner Door Glass	25
Something Not Working?	26
Service and Spare Parts	27
Guarantee Conditions	28
Notes	29

PREFACE

Dear Customer,

Thank you for buying a Tricity Bendix appliance. With our 80 years experience in developing and manufacturing the very best in U.K. appliances, you can be assured that you have purchased a hard working, reliable, quality product.

Tricity Bendix appliances comply with British Standard safety and performance requirements. They have been approved by BEAB (British Electrotechnical Approvals Board) and are covered by a 12 month parts and labour guarantee.

To get the best from your new Tricity Bendix appliance, we ask that you PLEASE READ THESE INSTRUCTIONS CAREFULLY. Particular attention should be made to cooking times and temperatures, which may differ, from your previous appliance.

It is most important that this instruction book is retained with the appliance for future reference. Should the appliance be sold, or if you move house and leave the appliance, always ensure that the book remains with the appliance. This will enable the new owner to be acquainted with the functioning of the appliance and the relevant warnings.

Please read the whole instruction book before attempting to use the appliance ensuring you follow the recommendations given.

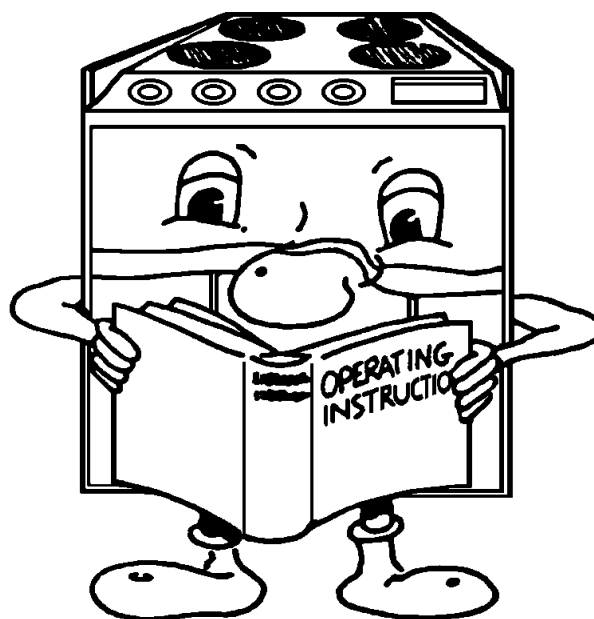

SAFETY

THESE WARNINGS ARE PROVIDED IN THE INTERESTS OF YOUR SAFETY. ENSURE THAT YOU UNDERSTAND THEM ALL BEFORE INSTALLING OR USING THE APPLIANCE.

PLEASE
READ
CAREFULLY

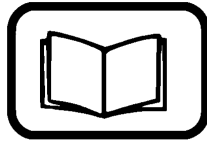

BEFORE INSTALLATION



This appliance is heavy and care **must** be taken when moving it.



Ensure that all packaging, both inside and outside the appliance has been removed before the appliance is used.

If the appliance is to be placed on a base, measures must be taken to prevent the appliance slipping from the base.



Do not try to *lift* or move the appliance by pulling the door handles.

The electrical installation work **must** be undertaken by a qualified electrician/competent person.



It is dangerous to alter or modify the specifications of the appliance in any way.



Do not allow young children to play with any part of the packaging.



After installation, please dispose of the packaging with due regard to safety and the environment, your local authority can arrange this.

DURING OPERATION

This appliance is not intended to be operated by means of an external timer or separate remote control system.



Do not use this appliance if it is in contact with water. **Never** operate it with wet hands.



This appliance is designed to be operated by adults. Young children **must not** be allowed to tamper with the appliance or play with the controls.

During use the appliance becomes **Hot**. Care should be taken to avoid touching the heating elements inside the oven.

CAUTION: Accessible parts may be hot when the grill is in use. Young children should be kept away.



Take **great care** when heating fats and oils, as they will ignite if they become too **hot**.

This appliance has been designed for cooking edible foodstuffs only, and **must not** be used for any other purposes.



Never place plastic or any other material which may melt in the oven or on the hob.



Ensure cooking utensils are large enough to contain foods to prevent spillages and boil overs.

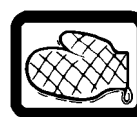

The handles of saucepans which are smaller than the heated area on the hob will become hot. **Ensure** your hand is protected before handling the pan.



Take care to follow the recommendations given for tending the food when grilling.



Do not leave the grill pan handle in position when grilling as it will become hot.



Always use oven gloves to remove and replace food in the oven. Similarly always use oven gloves to remove and replace the grill pan handle when grilling. Follow the recommendations on page 16.



Ensure that you support the grill pan when it is in the withdrawn or partially withdrawn position.

Ensure that all vents are left unobstructed to ensure ventilation of the oven cavity.

Ensure the anti-tilt shelves are put in place correctly. Refer to instructions on pages 16 and 18.

Never line any part of the appliance with foil. **Do not** allow heatproof cooking materials e.g. roasting bags, to come into contact with oven elements.

Always stand back from the appliance when opening the oven door to allow any build up of steam or heat to release.

Never leave the appliance unattended when the doors are open.

Do not place sealed cans or aerosols inside the oven. They may explode if they are heated.

Do not leave the hotplates switched ON for long periods when not covered by a saucepan. The controls and cabinets may overheat.

AFTER USE



Ensure that all control knobs are in the OFF position when not in use.



For hygiene and safety reasons this appliance should be kept clean at all times. A build-up of fats or other foodstuffs could result in a fire, especially in the grill pan.



Do not leave utensils containing foodstuffs, e.g. fat or oil in or on the appliance in case it is inadvertently switched ON.



Cookers and hobs become **very hot**, and retain their heat for a long period of time after use. Children should be kept well away from the appliance until it has cooled.

GENERAL

Under no circumstances should any repairs be carried out by an inexperienced person as this may cause injury or serious malfunction.

This appliance should be serviced by an authorised service Engineer and only genuine-approved spare parts should be used. Details of repair and servicing arrangements are supplied on page 27 of this book.

Do not stand on the appliance or on the open oven door.

Do not hang towels, dishcloths or clothes from the appliance or its handle. They are a safety hazard.

Only clean this appliance in accordance with the instructions given in this book.

Your safety is of paramount importance.

Therefore, if you are unsure about any of the meanings of these WARNINGS contact the:

**Customer Care Department
Telephone 0870 5 950950**

INTRODUCTION

WARNING: THIS APPLIANCE MUST BE EARTHED

RATING PLATE

This is situated on the lower front frame of the appliance and can be seen upon opening the door. Alternatively the rating plate may also be found on the back or top of some models (where applicable).

The appliance must be protected by a suitably rated fuse or circuit breaker. The rating of the appliance is given on the rating plate.

Do not remove the rating plate from the appliance as this may invalidate the guarantee.

INSTALLATION

If your appliance has been damaged in transit, contact your supplier immediately. **DO NOT** attempt to install it.

Your appliance left the factory fully packaged to protect it from damage. If it is delivered without packaging and damage has occurred, the manufacturer cannot accept responsibility. Contact your supplier for advice.

Once the packaging has been removed the appliance should only be moved by hand. **DO NOT** use a sack barrow or any other aid to lift the appliance as damage may occur.

Connection to the electricity supply must be carried out by a qualified electrician/competent person.

The electrical connection should be made using a double pole isolating switch (cooker socket) with at least 3mm contact separation in all poles. The cable must have conductors of sufficiently high cross-sectional area to prevent overheating and deterioration.

The recommended cross-section area is six square millimetres (6.00mm^2).

The cable should be routed away from potentially hot areas marked by X in the diagram below.

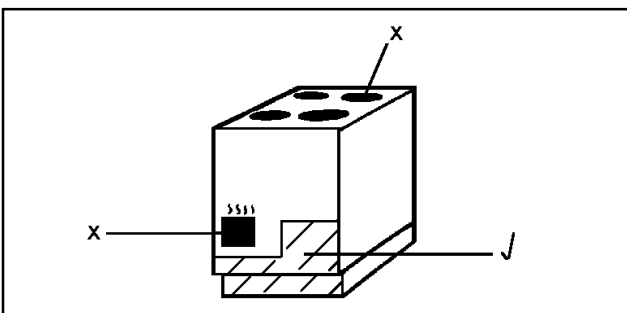

To move the appliance, open the oven door, and lift the appliance by holding inside the top of the compartment.

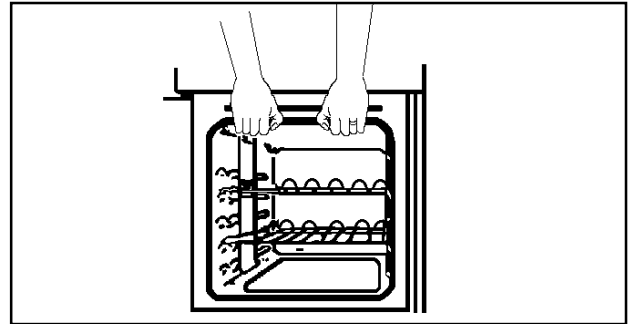

This is a type X appliance, which means it is free-standing and can be fitted with cabinets on one or both sides. It may also be fitted in a corner setting.

Side walls which are above hob level should be protected by heat resistant non-combustible material and **MUST NOT** be nearer than 40mm to the hob side.

A nominal air gap of 2mm at either side of the appliance is required to enable the appliance to be moved into position. It is recommended that proprietary trims are fitted to protect the worktops of either side of the appliance. These are available from most DIY stores.

Always ensure an air gap is maintained at hotplate level. Tiles or other forms of deep wall covering should not obscure this gap.

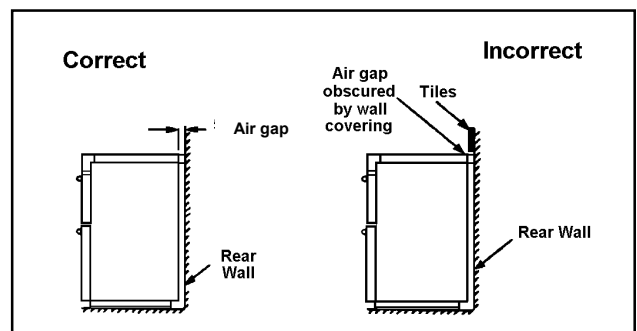

Overhanging surfaces or a cooker hood should be a minimum of 685mm above the hob.

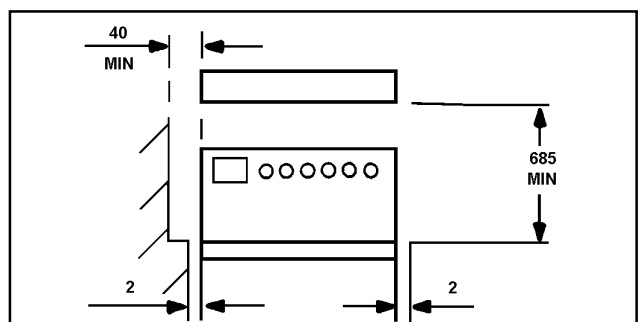

It is important to ensure that the appliance is level after installation. Levelling feet are fitted to the appliance to accommodate uneven floors.

GENERAL NOTES ON USING YOUR APPLIANCE

We suggest that you run the oven elements for 10 – 15 minutes at 220°C to burn off any residue from their surfaces. The procedure should be repeated with the grill for approximately 5 – 10 minutes. During this period an odour may be emitted, it is therefore advisable to open a window for ventilation.

ABOUT CONDENSATION AND STEAM

When food is heated it produces steam similar to a boiling kettle. The oven is vented to allow some of this steam to escape between the wall and the rear of the appliance. However, always stand back from the appliance when opening the oven door to allow any build up of steam or heat to release.

If the steam comes into contact with a cool surface on the outside of the appliance, e.g. a trim, it will condense and produce water droplets. This is quite normal and is not caused by a fault on the appliance.

To prevent discolouration, regularly wipe away condensation and also soilage from surfaces.

For your safety wall coverings at the rear of the appliance should be securely fixed to the wall.

CONTROL PANEL INDICATOR NEON

The light will indicate whether the oven is switched on, the neon also indicates when the set temperature has been reached. The neon will turn on and off during use to show that the temperature is being maintained.

THE COOLING FAN FOR THE CONTROLS

The cooling fan may not switch on except when used for a longer period of time. The cooling fan may run on, and turn on and off after the control knobs have been switched off, until the appliance has cooled. **Do not** switch the appliance off at its power point until the fan has cooled the appliance down.

GRILL AND OVEN FURNITURE

The following items of grill/oven furniture have been supplied with the appliance:

1 grill pan

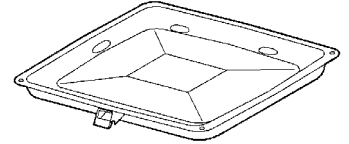

1 grill pan handle

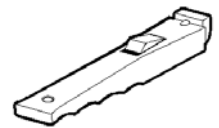

1 grill pan grid

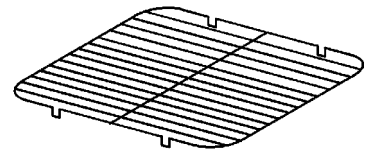

1 straight shelf
for grilling only

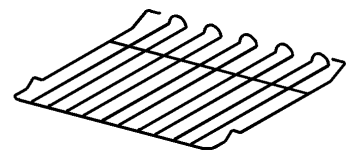

2 straight shelves
for fan oven cooking

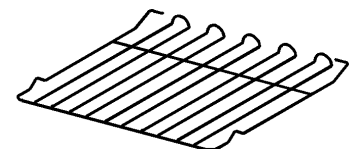

GETTING TO KNOW YOUR APPLIANCE

THE CONTROL PANEL

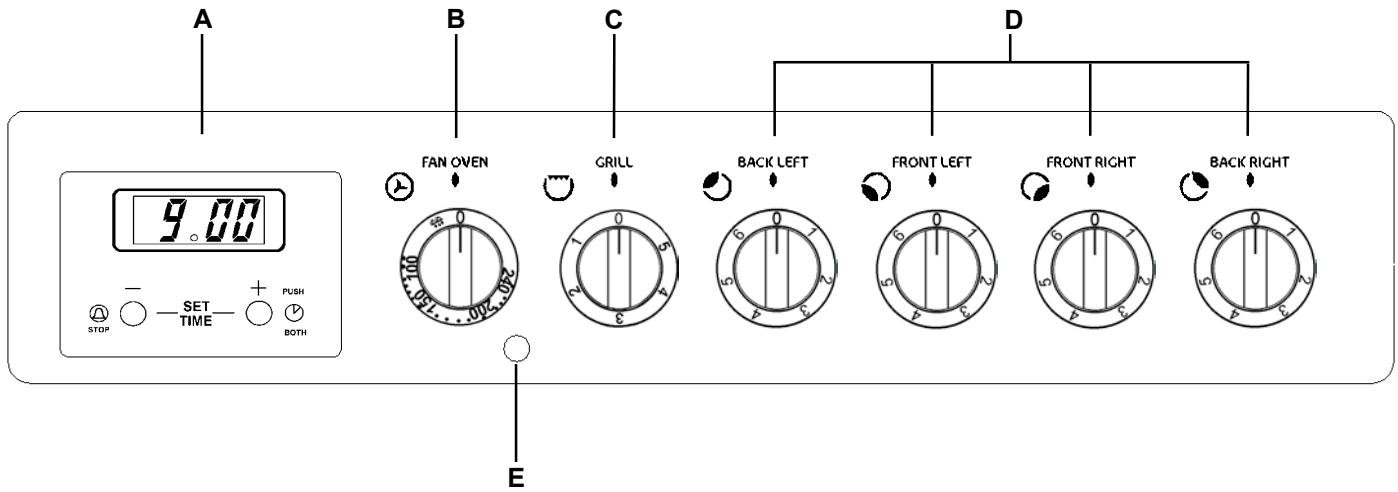

FEATURES

- A - Electronic Minute Minder
- B - Fan Oven Temperature Control
- C - Grill Control
- D - Hotplate Controls
- E - Fan Oven Indicator Neon

ELECTRONIC MINUTE MINDER

- 1 = (-) DECREASE CONTROL & MINUTE MINDER
- 2 = (+) INCREASE CONTROL
- () COOKPOT SYMBOL

The electronic minute minder can indicate the time of day, operate as a minute minder and it can be used to time and switch off the oven.

Please note that this is a 24 hour clock, for example 2.00pm is shown as 14.00.

In the following pages we explain how to use the minute minder and set the time of day. Read through them until you are familiar with the procedure.

1. SET THE TIME OF DAY

When the electricity supply is first switched ON, the display will flash 0.00. See Fig.1.

Press buttons (1) and (2) together. Release buttons, 0.00 will appear in the display as Fig. 2. **Within 5 seconds** press button (2), 12.00 will show in the display as Fig. 3.

Within 5 seconds press and hold either button (1) to decrease or button (2) to increase the time until the correct time of day on the 24 hour clock is reached, e.g. 14.30. See Fig. 4.

Note: The increase and decrease control buttons operate slowly at first, and then more rapidly. They should be pressed separately.

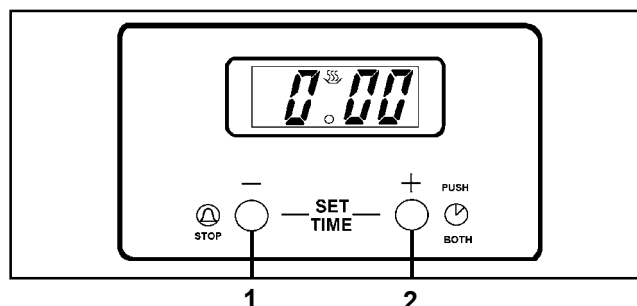

Fig.1

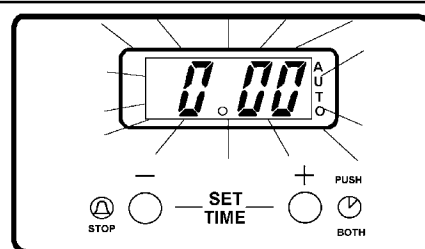

Fig.2

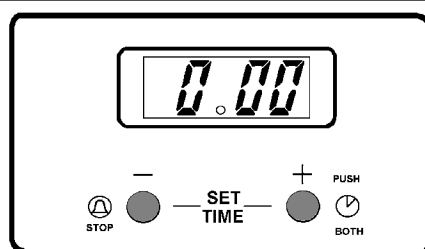

Fig.3

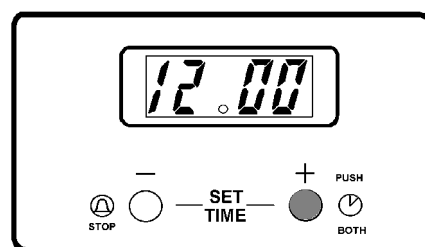
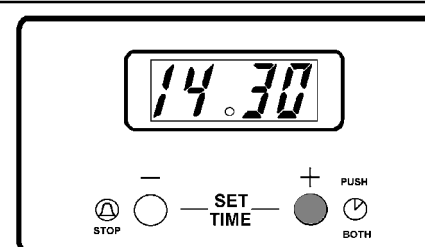

Fig.4



2. THE MINUTE MINDER

IMPORTANT

The minute minder can be used to time a set cooking period. At the end of the cook time the minute minder will automatically switch off the oven if in use.

The minute minder gives an audible reminder at the end of any period of cooking up to 23 hours and 59 minutes.

To set press button (1) and the display will read 0.00, see Fig. 5.

Release button (1) and press and hold button (2). The display will count up in one minute intervals until the interval to be timed is reached e.g. 30 minutes, see Fig. 6. If necessary press and hold button (1) to achieve the correct time interval.

The minute minder will begin to count down once set. The time of day will show in the display. To show the remainder of the cook time. Press button (1).

At the end of the timed period the minute minder will click, switching the oven OFF if in use.

An audible signal will sound for up to 2 minutes. The Auto symbol will flash and the cookpot symbol will go out. The time of day will show in the display. See Fig. 7.

To stop the sound press button (1). The display will stop flashing and show the time of day, e.g. 15.00. To return the timer to manual press button (1) again. See Fig. 8. If using the oven it will come on again once button (1) has been depressed. When cooking is complete remove food and turn OFF oven temperature control.

3. TO CANCEL THE MINUTE MINDER

If you change your mind and want to cancel the minute minder. Press and release button (1). Press and hold button (1) and the display will count down in one minute intervals to 0.00. See Fig. 9. Release button (1).

After a few seconds the time of day will show in the display. See Fig. 10.

If the oven is in use this will switch OFF after a few seconds.

To reset, press buttons (1) and (2) together. See Fig. 11.

4. THINGS TO NOTE

1. The time of day must be set before the oven will operate. There will be a few seconds delay before the oven switches on.
2. The minute minder function controls the oven and will switch the oven OFF at the end of a timed period. This function is useful if you want to begin cooking now and have the oven switch OFF automatically.
3. If you have used the minute minder to time food cooking in the oven you will need to reset the timer by pushing button (1) before the oven can operate again.

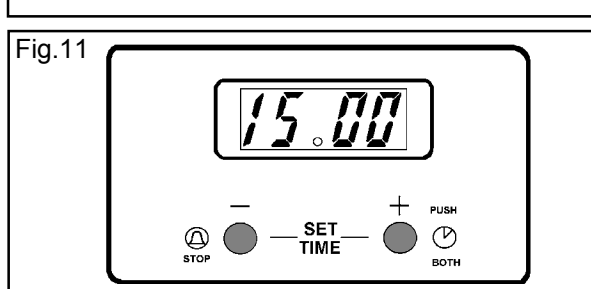
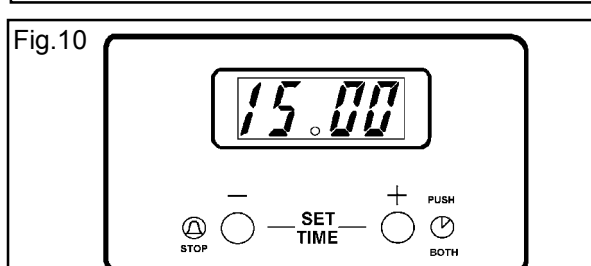
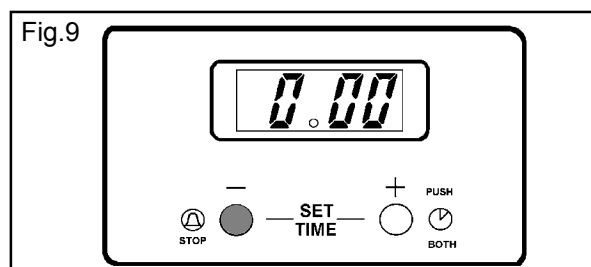
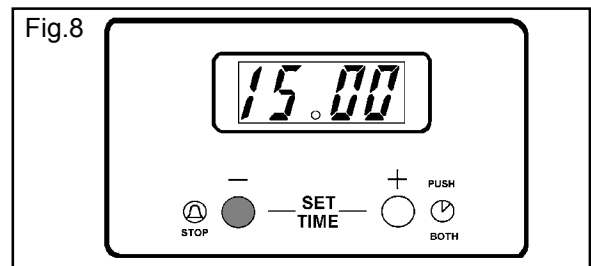
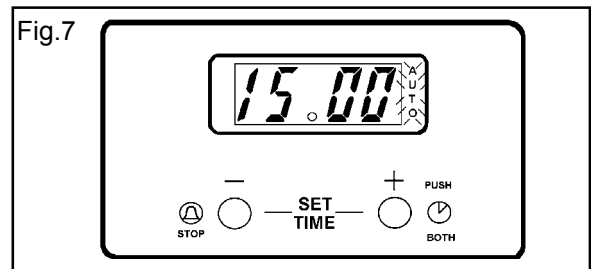
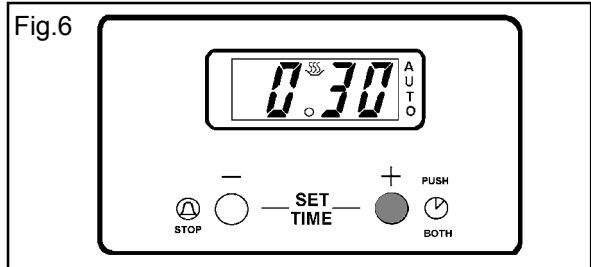
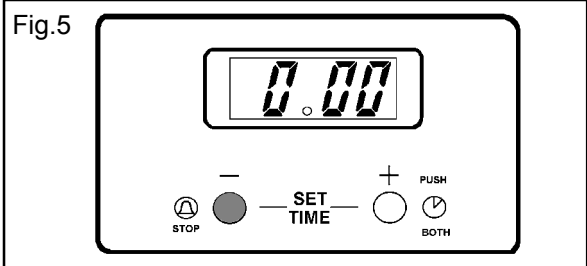

5. LOCK FEATURE - OVEN ONLY

Please read the following information with care.

TO LOCK THE OVEN USING THE TIMER

Press and hold Buttons (1) and (2) on your timer for 3 - 8 seconds. See Fig. 12.

'ON' will appear in the display. See Fig. 13.

Press Button (2) to change the display to 'Of'.

The key symbol () appears in the display.

The oven will now not operate.

After a few seconds the time of day will show in the display.

Wait 3 seconds before selecting another function.

TO UNLOCK THE OVEN

Press and hold Buttons (1) and (2) for 3 - 8 seconds.

'Of' will appear in the display. See Fig. 14.

Press Button (2) to change the display to 'On'.

The key symbol () will go out.

After a few seconds the time of day will show in the display.

The oven can now be operated normally.

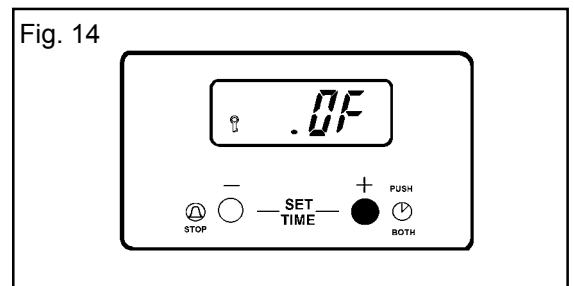
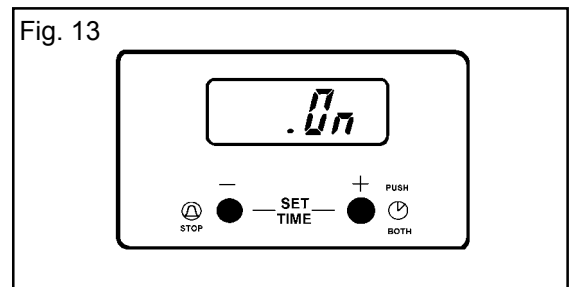
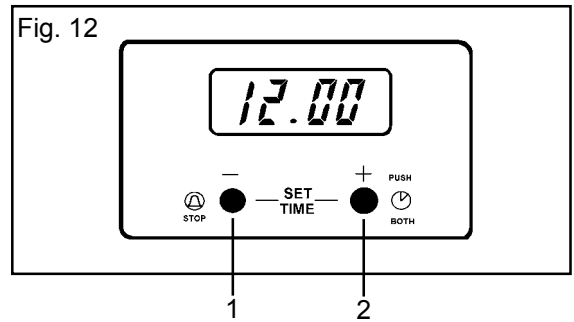

THE SEALED HOTPLATES

BEFORE USING THE HOTPLATES FOR THE FIRST TIME

Turn the control knob to a medium/high setting and allow the hotplate to heat, uncovered by a saucepan for 3-5 minutes. This hardens the protective coating on the hotplates and makes it more resistant to normal use. A harmless smoke will be given off from the hotplates.

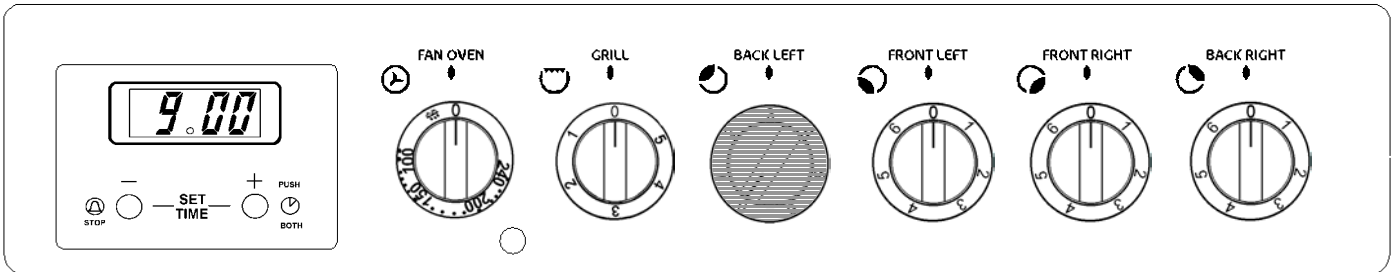

- To operate the hotplates turn the control knobs in either direction to vary the heat setting.
- The highest number represents the hottest setting and the lowest number represents the coolest setting. Choose a setting appropriate to the quantity and type of food to be cooked.

RECOMMENDED SAUCEPANS

For speed and economy only good quality saucepans with flat bases and close fitting lids are recommended.

To check the flatness of the saucepan, place a ruler across the pan base, hold at eye level and look for light showing. There should be very little or no light visible between the ruler and the pan base.

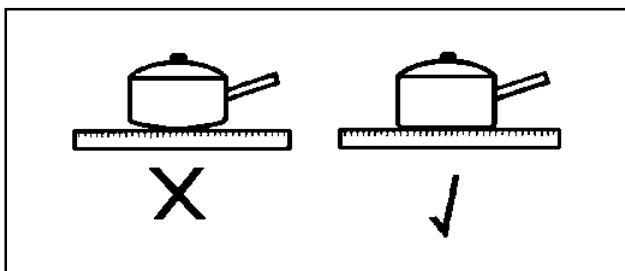

The size of the base of the saucepan should be the same or up to 2.5cm/1 inch larger than the hotplate. If the base is too small, energy will be wasted, boilovers will also be more difficult to deal with as spillage will fall directly onto the hotplate.

Pressure cookers, preserving pans etc., should comply with the recommendations given above. Traditional round bottomed Woks **must not be** used even with a stand. Woks with flat-bottomed bases are available and do comply with the above recommendations.

HINTS AND TIPS

- Lift, rather than slide saucepans on and off the hob to help reduce scratches and maintain the efficiency of the hotplates.

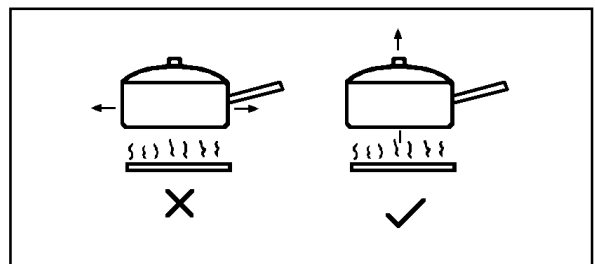

- Avoid the use of decorative covers as they can cause condensation to form on the hotplates which may lead to deterioration.
- Follow any guidelines provided by the saucepan manufacturer, particularly those relating to recommended heat settings.
- Avoid using thin, badly dented or distorted saucepans as they can lead to sticking and burning of food.

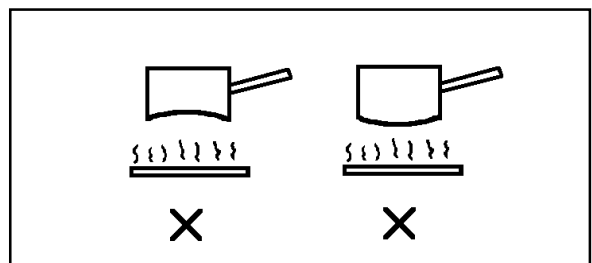

- To prolong the life of the hotplates:
 - Never use utensils with a skirt, e.g. a bucket.
 - Never use an asbestos mat.
 - Never leave the hotplates ON when not covered with a saucepan.

DEEP FAT FRYING

SPECIAL FRYING NOTE:

For safety purposes when deep fat frying, fill the pan one third full of oil, **DO NOT** cover the pan with a lid and **DO NOT** leave the pan unattended. In the unfortunate event of a fire, switch the appliance OFF at the electricity supply and cover the pan with a lid or damp cloth to assist in smothering the flames.

DO NOT use water on the fire. Leave the pan to cool for at least 30 minutes before moving it.

DO NOT leave the fat or oil in the frying pan on the hob to store it in case the hob is inadvertently switched ON.

1. Preparing the food.

Seal the food by coating with flour, egg and breadcrumbs or batter. **Do not** use a basket with batter coated foods as they will stick.

2. Amount of oil.

For safety purposes fill the pan only one-third full of oil.

3. Testing the temperature of the oil.

It is advisable to use a thermometer to test the temperature of the oil. Alternatively, drop a small cube of bread into the oil which should brown in just under a minute if the oil is at the correct temperature of 190°C/375°F.

4. Cooking the food.

Lower the food gently into the oil. **Do Not** add too much food at once or the temperature of the oil will be reduced and may result in soggy, greasy food.

Turn the food if necessary; doughnuts float to the surface so will not brown on the upperside if not turned. Once cooked, drain the food on absorbent paper.

5. Double frying chips.

Double frying will ensure good chips. First fry the chips for a few minutes at 170°C/340°F to seal the outside. Remove the chips from the oil. Increase the temperature of the oil to 190°C/375°F to finish cooking and brown the chips.

Chips may be kept for several hours after the first frying before finishing off with the second frying.

6. Frying temperatures

	Celsius Scale (°C)	Fahrenheit Scale (°F)
	150	300
First frying of potatoes	170 175 180	340 350 360
Second frying of potatoes Frying chicken and fish	190 195 200	375 380 390

PRESERVING

1. **DO NOT** use a pan that overlaps the perimeter of the hob trim.

2. To allow for a full rolling boil, the pan should be no more than one third full when all the ingredients have been added. It is better to use two pans rather than overfill one, or use half quantities.

3. Use firm fruit or vegetables and wash well before using.

4. Preserving sugar gives clear jam, however granulated sugar is cheaper and gives equally good flavour.

5. Crystallization may be caused if sugar is not completely dissolved before bringing jam to the boil. Over boiling will affect the flavour, setting properties and colour of the jam.

6. To test jam for setting:

If a jam thermometer is available, boil jam to 104°C. Marmalade should be boiled to 106°C.

If a jam thermometer is not available, remove pan from heat, place sample of jam on a cold dish and cool quickly (i.e. in a freezer or frozen food storage compartment of a refrigerator). When cold, it will crinkle and hold the mark of a finger run through it, if it is at setting point.

7. The scum should be removed as soon as possible after setting point has been reached. Marmalade should be allowed to cool before potting to prevent the peel rising.

THE GRILL

CAUTION – ACCESSIBLE PARTS MAY BECOME HOT WHEN THE GRILL IS IN USE. CHILDREN SHOULD BE KEPT AWAY.

SELECTING THE GRILL

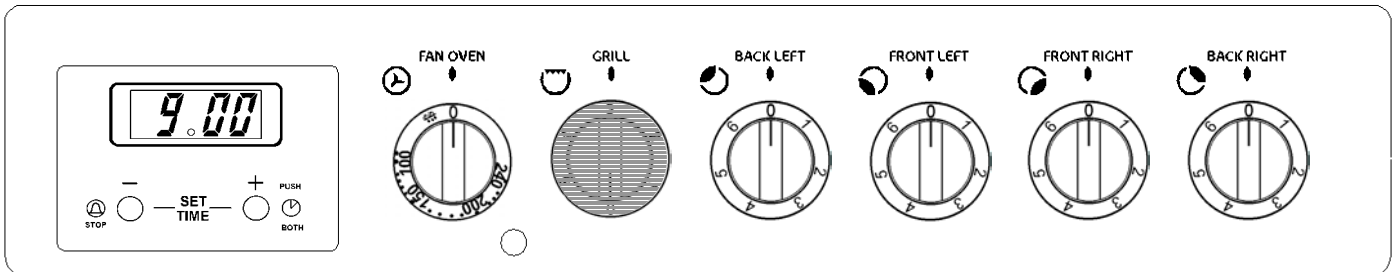

- To operate the grill open the grill door and turn the grill control in either direction.
- The highest number represents the hottest setting and the lowest number represents the coolest setting.
- Setting 5 represents the grill on Full.

At lower settings the grill may turn on and off over time and you may prefer to use these settings for keeping food warm. The food will however continue to cook gently if the grill is used for this purpose.

THINGS TO NOTE

THE GRILL DOOR MUST BE LEFT OPEN DURING GRILLING.

Closing the grill door will cut OFF the power to the grill element preventing incorrect use.

Some smoke from fat splashes may be evident as the grill cleans itself.

THE GRILL PAN AND HANDLE

The grill pan is supplied with a removable handle.

To insert the handle, press the button on the handle with the thumb and pivot the handle slightly upwards inserting the lip into the widest part of the bracket. Move the handle towards the left, lower into position and release the button.

Ensure the handle is positively located.

When removing the handle, press the button on the handle with the thumb and pivot the handle slightly upwards and towards the right to remove from the bracket.

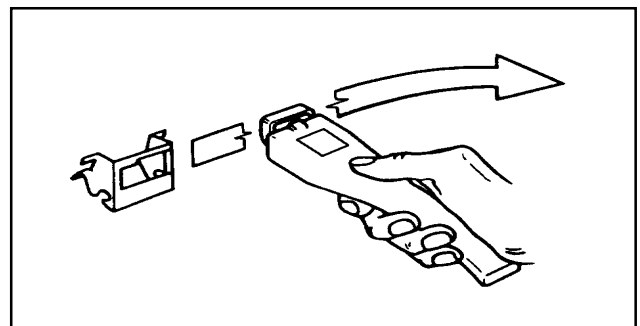

Ensure your hand is protected when removing the grill pan handle as the control panel trim and grill element can become very hot.

ALWAYS REMOVE THE GRILL PAN HANDLE DURING GRILLING.

To correctly locate the grill pan on the shelf, ensure that the cut out on the underside of the handle bracket locates over the front bar of the shelf.

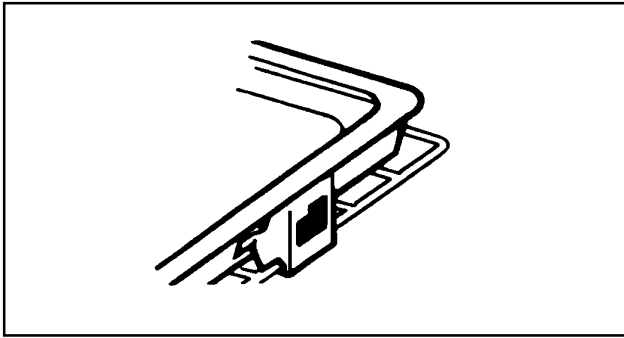

To check the progress of the food being grilled, the grill pan should be withdrawn on the shelf to tend the food during cooking.

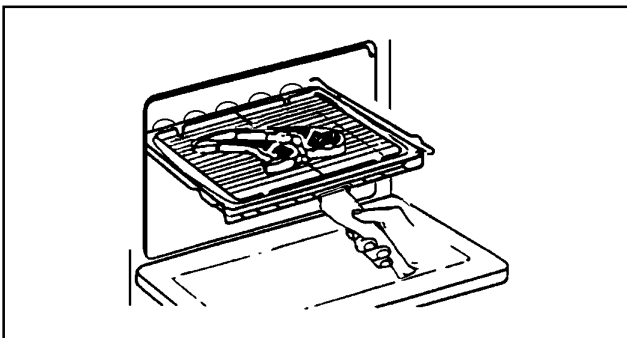

HINTS AND TIPS

- Food should be thoroughly dried before grilling to minimise splashing. Brush lean meats and fish lightly with a little oil or melted butter to keep them moist during cooking.
- Adjust the height of the grilling grid and grill pan runner position to allow for different thicknesses of foods.

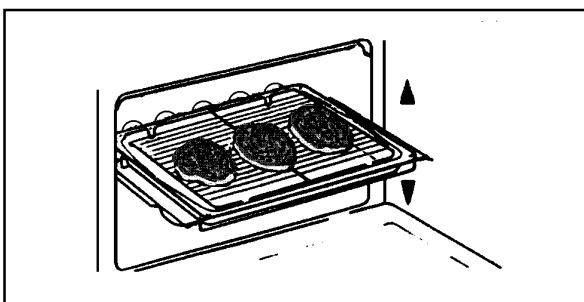

- Place food on the grill pan or grid directly onto the grill pan base.

- Accompaniments such as tomatoes and mushrooms may be placed underneath the grid when grilling meats.

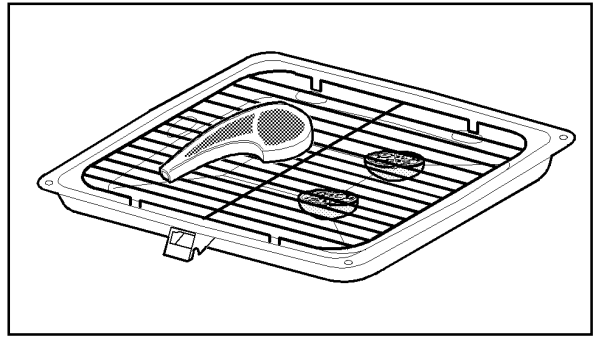

- When toasting bread use the shelf in position 1 with the grid in the high position and placing the bread in the centre of the grid.
- Preheat the grill on a full setting for five minutes before cooking. Adjust the shelf as necessary during cooking.
- The food should be turned over during cooking as required.

GRILLING CHART

FOOD	RUNNER POSITION	GRILL TIME (mins in total)
Bacon Rashers	1	2-3 each side
Beefburgers	1	6-10 each side
Chicken Joints	1	15-20 each side
Chops - Lamb	1	7-10 each side
Pork	1	10-15 each side
Fish – Whole Trout/Mackerel	1	8-12 each side
Filletts – Plaice/Cod	1	4-6 each side
Kebabs	1	10-15 each side
Kidneys – Lamb/Pig	1	4-6 each side
Liver – Lamb/Pig	1	5-10 each side
Sausages	1	10-15 each side
Steaks - Rare	1	3-6 each side
Medium	1	6-8 each side
Well Done	1	7-10 each side
Toasted Sandwiches	1	1¼-1½ each side

Shelf positions are counted from the bottom up.

The times quoted above are given as a guide and should be adjusted to suit personal taste.

THE FAN OVEN

USES OF THE FAN OVEN

The oven is heated by the element around the fan situated behind the back panel. The fan draws air from the oven, the element heats the air which is circulated into the oven via the vents in the back panel. The advantages of fan oven cooking are:

PREHEATING

The fan oven quickly reaches its temperature, so it is not usually necessary to preheat the oven. Without preheating however, you may find you need to add an extra 5 – 10 minutes on the recommended cooking times. For recipes needing high temperatures, e.g. bread, pastries, scones, soufflés etc., best results are achieved if the oven is preheated first. For best results when cooking frozen or cooked chilled ready meals always preheat the oven first.

COOKING TEMPERATURES

Fan oven cooking generally requires lower temperatures than conventional cooking. Follow the temperatures recommended in the chart on page 20. As a guide reduce temperatures by about 20°C – 25°C for your own recipes, using a conventional oven.

BATCH BAKING

The fan oven cooks evenly on both shelf levels, especially useful when batch baking.

SELECTING THE FAN OVEN

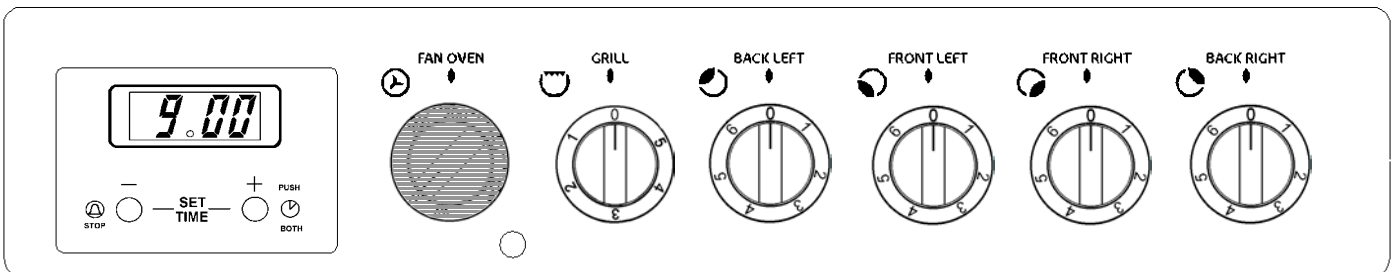

- Turn the fan oven temperature control to the required setting.

THINGS TO NOTE

- The fan oven indicator neon will glow until the oven has reached the desired temperature and then go out. It will turn ON and OFF periodically during cooking showing that the temperature is being maintained.
- The cooling fan for the controls may switch in after a time. See page 9 for more information on the operation of the cooling fan.

TO FIT THE FAN OVEN SHELVES

The shelves should be fitted with the straight rods uppermost on the frame and the forms towards the back of the oven. If not fitted correctly the anti-tilt and safety stop mechanism will be affected.

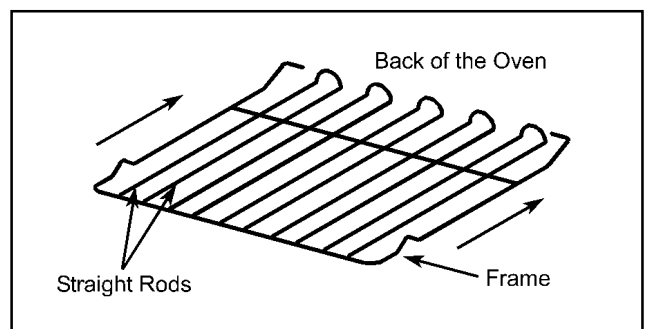

HINTS AND TIPS

- Arrange the shelves in the required positions before switching the oven ON. Shelf positions are numbered from the bottom upwards.

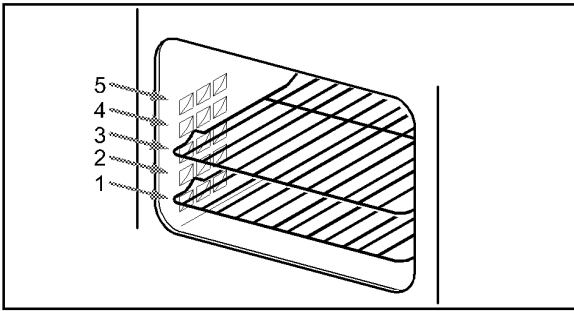

- When cooking more than one dish in the fan oven, place dishes centrally on different shelves rather than cluster several dishes on one shelf, this will allow the heat to circulate freely for the best cooking results.
- When batch baking one type of food, e.g. Victoria sandwich cakes, those of similar size will be cooked in the same time.

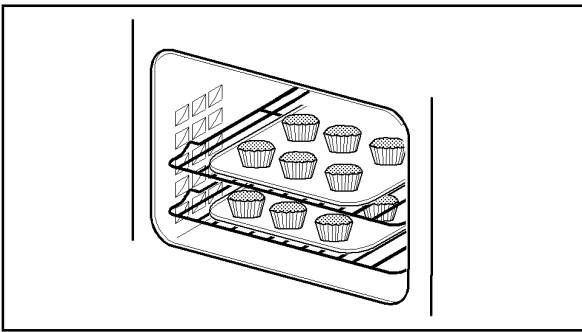

- It is recommended that when baking larger quantities the shelf positions should be evenly spaced to suit the load being cooked. A slight increase in cooking time may be necessary.
- The use of excessively high temperatures can cause uneven browning. It may be necessary to reduce temperatures slightly. Refer to the recommendations given in the oven cooking chart, see page 20.
- **Do not** place baking trays directly on the oven base as it interferes with the oven air circulation and can lead to base burning; use the lower shelf position.

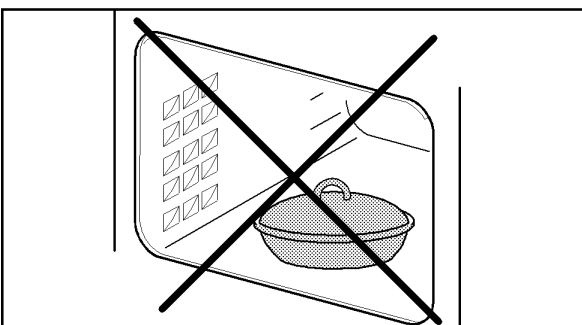

OVEN COOKING CHART

The oven temperatures are intended as a guide only. It may be necessary to increase or decrease the temperatures by 10°C to suit individual preferences and requirements.

FOOD	OVEN SHELF POSITIONS	COOKING TEMP (°C)	APPROXIMATE COOK (TIME MINS)
Biscuits	3	190 - 200	10 - 20
Flapjacks	3	180 - 190	25 - 30
Shortbread	3	150 - 160	45 - 65
Bread	2	220	30
Bread rolls/buns	2	220	30
Casseroles- Beef/Lamb	3	140 - 150	2 - 3 h
Chicken	3	180 - 190	1½ h
Cakes: Small & Queen	3	180 - 190	20 - 25
Victoria sandwich	2	180 - 190	20 - 25
Gingerbread	3	150 - 160	1¼ - 1½ h
Madeira	2	140 - 150	1 - 1¼ h
Rich fruit	2	150 - 160	2¼ - 2¾ h
Christmas	1	140 - 150	Depending on size 3 - 4½ h
Meringues	3	100	2½ - 3 h
Convenience foods	2	Follow instructions on the pack	
Fish	2	180 - 190	20 - 30
Fish pie (potato topped)	3	200 - 210	20 - 25
Shepherds pie	3	200 - 210	30 - 35
Fruit pies and crumbles	3	210 - 220	40 - 45
Milk puddings	3	150 - 160	1½ - 2 h
Pastry: Choux - Chocolate Eclairs	4	200 - 210	20 - 25
Profiteroles	4	200 - 210	20 - 25
Shortcrust – Mince pies	3	200 - 210	15 - 20
Flaky/Puff pies	3	220 - 230	30 - 40
Quiche Lorraine/tarts/flan	3	200 - 210	30 - 45
Meat pie	3	200 - 210	30 - 45
Plate tarts/pies	3	200 - 210	30 - 45
Scones	2	230 - 240	8 - 12
Soufflé	3	200	30 - 40
Roasting Meat and Poultry	2	180 - 200	See Roasting Chart
Pasta e.g. Lasagne	2	200	30 - 40
Vegetable dishes	3	200	1½ h
Baked jacket potatoes	3	200	1 - 1½ h
Roast potatoes	3	200 - 220	1 - 1½ h
Yorkshire puddings: Large	3	230	35 - 40
Individual	3	230	35 - 40

Note: Shelf positions are counted from the bottom of the oven.

ROASTING CHART

ROASTING CHART		
INTERNAL TEMPERATURES – Rare : 50-60°C; Medium : 60-70°C; Well done : 70-80°C		
MEAT	FAN OVEN	COOKING TIME
Beef	160-180°C	20-35 minutes per ½kg (1lb) and 20-35 minutes over
Beef, boned	160-180°C	25-35 minutes per ½kg (1lb) and 25-35 minutes over
Mutton and Lamb	160-180°C	25-35 minutes per ½kg (1lb) and 25-35 minutes over
Pork and Veal	160-180°C	30-40 minutes per ½kg (1lb) and 30-40 minutes over
Ham	160-180°C	30-40 minutes per ½kg (1lb) and 30-40 minutes over
Chicken	160-180°C	15-20 minutes per ½kg (1lb) and 20 minutes over
Turkey and Goose	160-180°C	15-20 minutes per ½kg (1lb) up to 3½kg (7lb) then 10 minutes per ½kg (1lb) over 3½kg (7lb)
Duck	160-180°C	25-35 minutes per ½kg (1lb) and 25-30 minutes over
Pheasant	160-180°C	35-40 minutes per ½kg (1lb) and 35-40 minutes over
Rabbit	160-180°C	20 minutes per ½kg (1lb) and 20 minutes over
Potatoes with meat	160-180°C	according to size
Potatoes without meat	180-190°C	according to size

The roasting temperatures and times given in the chart should be adequate for most joints, but slight adjustments may be required to allow for personal requirements and the shape and texture of the meat. However, lower temperatures and longer cooking times are recommended for less tender cuts or larger joints.

Wrap joints in foil if preferred, for extra browning uncover for the last 20 – 30 min. cooking time.

DEFROST FEATURE

USES OF DEFROST FEATURE

This fan oven function defrosts most foods faster than more conventional methods. It is particularly suitable for delicate frozen foods which are to be served cold e.g. cream filled gateaux, cakes covered with icings or frostings, cheesecakes, biscuits, scones, etc.

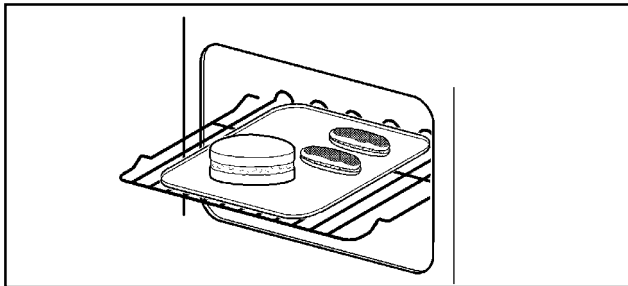

It is preferable to thaw fish, meat and poultry slowly in the fridge. However, this process can be accelerated by using the defrost function.

SELECTING DEFROST

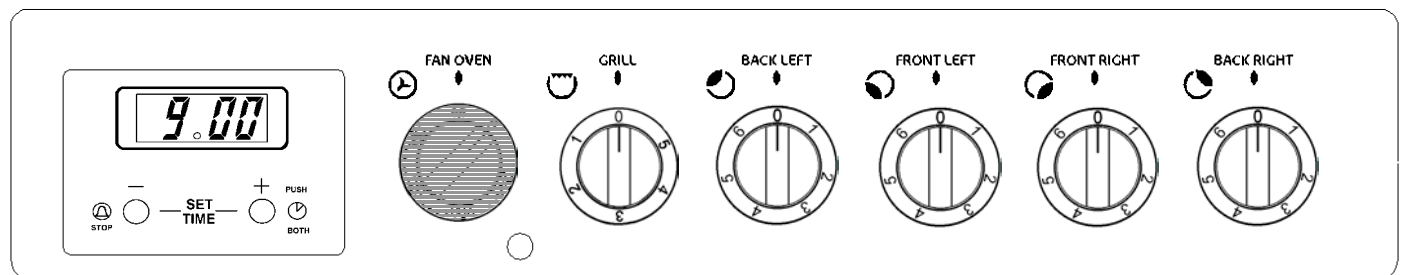

- Turn the fan oven temperature control to the defrost setting. 
- When defrost is selected, the oven indicator neon may come ON. It will stay ON until the oven reaches room temperature and then go OFF.
- It may turn ON and OFF periodically during defrosting to maintain a steady room temperature, inside the oven.

THINGS TO NOTE

Care must always be taken when handling foods in the home. Always follow the basic rules of food hygiene to prevent bacterial and microbial growth and cross contamination when defrosting, preparing, cooking, cooling and freezing foods.

Small or thin fish fillets, frozen peeled prawns, cubed or minced liver, thin chops, steaks etc., can be thawed in 1 – 2 hours.

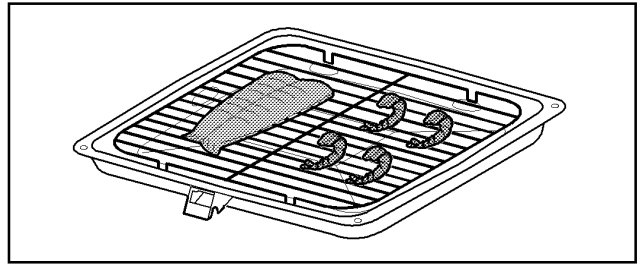

A 1kg/2¼lb oven ready chicken will be thawed in approximately 5 hours. Remove the giblets as soon as possible during the thawing process.

Joints of meat up to 2kg/4½lb in weight can be thawed using the defrost function.

ALL JOINTS OF MEAT AND POULTRY MUST BE THAWED THOROUGHLY BEFORE COOKING.

ALWAYS COOK THOROUGHLY IMMEDIATELY AFTER THAWING.

HINTS AND TIPS

- Place the frozen food in a single layer where possible and turn it over half way through the defrosting process.

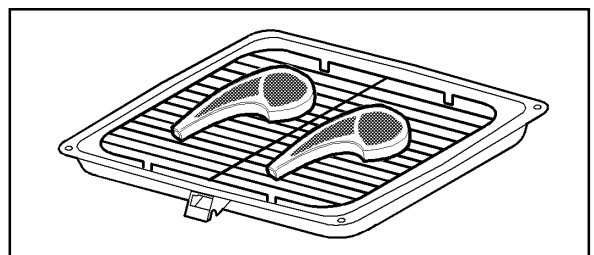

- The actual speed of defrosting is influenced by room temperature. On warm days defrosting will be faster than on cooler days.
- **DO NOT** leave food at room temperature once it is defrosted. Cook raw food immediately or store cooked food in the fridge, once it has cooled.

CARE AND CLEANING

BEFORE CLEANING THE APPLIANCE, ALWAYS ALLOW THE COOLING FAN TO COOL THE APPLIANCE DOWN BEFORE SWITCHING OFF THE ELECTRICITY SUPPLY.

CLEANING MATERIALS

Before using any cleaning materials on your appliance, check that they are suitable and that their use is recommended by the manufacturer.

Cleaners that contain bleach should NOT be used as they may dull the surface finishes. Harsh abrasives should also be avoided.

CLEANING THE HANDLES

It is strongly recommended that only soapy water is used for cleaning the handles.

CLEANING THE OUTSIDE OF THE APPLIANCE

DO NOT use abrasive cleaning materials, or scourers on the outside of the appliance as some of the finishes are painted and damage may occur. Regularly wipe over the control panel, oven doors and cooker sides using a soft cloth and liquid detergent.

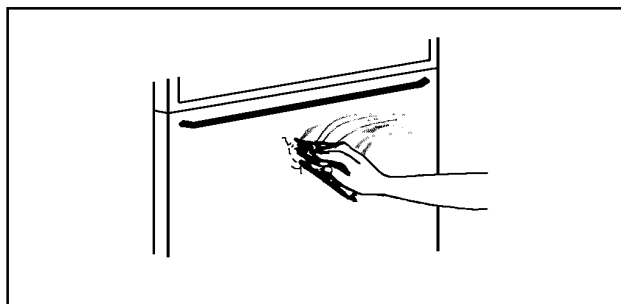

DO NOT ATTEMPT TO REMOVE ANY OF THE CONTROL KNOBS FROM THE APPLIANCE AS THIS MAY CAUSE DAMAGE AND IS A SAFETY HAZARD.

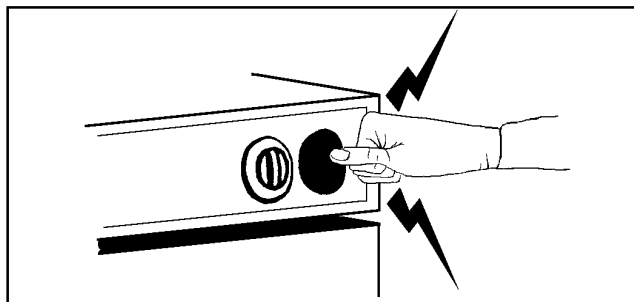

CLEANING THE SEALED HOTPLATES AND HOTPLATE TRIMS

In order to maintain the appearance of your appliance's sealed hotplates and trims, you are advised to use the recommended cleaning agents daily. If you do not allow spillages to burn on they will be much easier to clean off.

THINGS TO NOTE

The red spot in the centre of the hotplates may be removed with some abrasive cleaning agents. This is not a fault and does not affect the performance of the hotplates.

FOR NORMAL SOILAGE

Wipe over the hotplates and trims using a clean damp cloth then switch to a low or medium setting for a few minutes to thoroughly dry.

FOR HEAVY SOILAGE

Use a clean damp cloth or scourer with a cream cleaner e.g. 'Cif' or a powder cleaner e.g. 'Ajax' on the hotplate and trims. Follow the circular grooved pattern on the hotplate when cleaning. Rinse off cleaning agents thoroughly. Dry as for normal soilage.

For more stubborn marks warm the hotplate on a low setting for 30 seconds. Clean the sealed plate with 'Ajax' powder cleaner, 'Cif' or cream cleaner or a 'Brillo' pad. You may have to rub hard for several minutes.

Rinse off cleaning agents thoroughly with a damp cloth. Switch to a low or medium setting for a few minutes until the hotplate is thoroughly dry.

CLEANING THE HOTPLATE TRIMS

The stainless steel trims may become straw coloured during use. Using a proprietary stainless steel cleaner, e.g. 'Shiny Sinks' will help maintain a bright appearance. Alternatively a powder cleaner such as 'Bar Keepers Friend' may be used regularly.

CLEANING THE VITREOUS ENAMEL

Use a clean damp cloth or scourer made for non-stick saucepans with 'Cif' or cream cleaner.

AFTER CLEANING

To maintain the appearance of the hotplates occasionally apply a little salt free vegetable oil or commercial restorative agent.

To apply vegetable oil, first heat the hotplate on a medium setting for 30 seconds then turn OFF. Pour a very small amount of oil onto kitchen paper, apply the paper to the hotplate and wipe off any excess oil. Heat the hotplate on a medium setting for 1 minute.

To apply restorative agent, apply a thin coating of '4 Hob' or use a 'Minky' Hotplate Cleaning Cloth following the manufacturers instructions.

CLEANING THE GRILL AND OVEN FURNITURE

All removable parts except the grill pan handle can be washed in the dishwasher.

The grill pan, grill pan grid and oven shelves may be cleaned using a soap impregnated steel wool pad. Soaking first in hot soapy water will make cleaning easier.

CLEANING INSIDE THE OVEN AND GRILL COMPARTMENTS

The fan oven sides and back panel is coated with a Stayclean coating.

The Stayclean surfaces inside the oven should not be cleaned manually. See 'Care of Stayclean Surfaces'.

Aerosol cleaners must not be used on the Stayclean surfaces and must not come into contact with elements as this may cause damage.

For advice on how to keep the Stayclean finish in good condition see 'Care of Stayclean Surfaces'.

The vitreous enamel top oven / grill compartment and fan oven base can be cleaned using normal oven cleaners or aerosol oven cleaners with care. Ensure that the manufacturers instructions are followed and that all parts are well rinsed afterwards.

CARE OF STAYCLEAN SURFACES

The Stayclean surface destroys splashes of food and fats when the oven temperature is raised to around 220°C.

It is a good idea to run the oven for an hour or two per week to ensure continued good performance from the Stayclean finish.

HINTS AND TIPS

- Manual cleaning of the Stayclean surfaces IS NOT recommended. Damage will occur if abrasives or aerosol sprays of any kind are used.
- Slight discolouration and polishing of the Stayclean surfaces may occur in time. This **DOES NOT** affect the Stayclean properties in any way.
- A good time to allow the oven to run on is after the weekly roast. After removing the roast, turn the oven up to 220°C and allow to run for an hour or so. It is important not to allow a build-up of soilage as this can prevent the Stayclean surfaces from working.
- Follow the recommendations below to keep oven soilage to a minimum.
- Cook at the recommended temperatures. Higher temperatures during roasting will increase soilage. Try cooking at lower temperatures for an increased length of time, you will save energy and often the joint is more tender.
- Use minimal, if any, extra oil or fat when roasting meat, potatoes only require brushing with fat before cooking. Extra fat in the oven during roasting will increase splashing and soilage.
- It is **not** necessary to add water to a meat tin when roasting. The water and the fat juices from the joint create excessive splattering during cooking even at normal temperatures as well as causing condensation.
- Covering joints during cooking will also prevent splashing onto the interior surfaces. Removing the covering for the last 20-30 minutes will allow extra browning if required. Some large joints and turkeys especially benefit by this method of cooking, allowing the joint to cook through before the outside is over-browned.

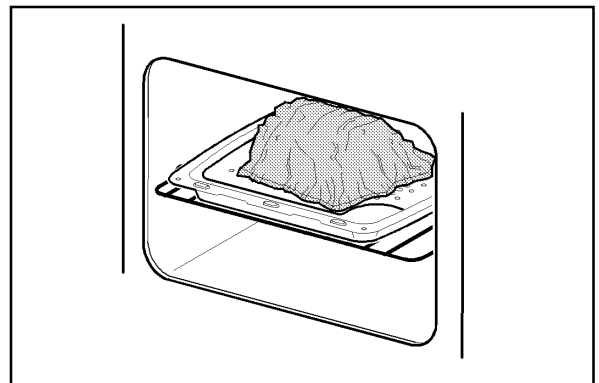

CLEANING THE DOOR GLASS



To prevent damaging or weakening the door glass panels avoid the use of the following:

- Household detergents and bleaches
 - Impregnated pads unsuitable for non-stick saucepans
 - Brillo/Ajax pads or steel wool pads
 - Chemical oven pads or aerosols
 - Rust removers
 - Bath/Sink stain removers
-

CLEANING BETWEEN THE OUTER AND INNER DOOR GLASS

The outer door glass is removable for cleaning.

TO REMOVE THE OUTER GLASS

1. Open the oven door slightly to gain access to the two cross head screws on the top of the oven door.
2. Loosen the two screws using a Pozidrive screwdriver.

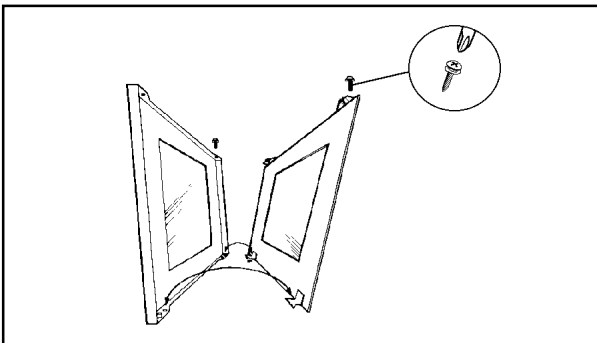

3. Hold the door glass securely in place with one hand before removing the screws completely with the other hand.
4. Using both hands, gently tilt the top of the door glass towards you, lift slightly to disengage the locators from the two bottom brackets.
5. Clean the outer and inner glass using hot soapy water or Hob Brite cleaner may be used with care. **DO NOT** use Hob Brite on the Stainless Steel or painted finishes. **DO NOT** try to clean the foil which is inside the door. The foil is there to help keep the door cool, if it is damaged it will not work. Ensure that all parts are well rinsed and thoroughly dried before attempting to replace the outer door panel.

TO REPLACE THE OUTER GLASS

1. Holding the oven door glass with both hands, gently place the locators into the holes of the brackets at the bottom of the oven door.
2. Push the top of the oven glass towards the oven door, ensuring the screw location holes line up.
3. Hold the glass in place with one hand and insert the cross head screws into the location holes with the other hand. Give the screws one turn to ensure the glass is secure.
4. Tighten the screws positively with a Pozidrive screwdriver before closing the oven door.

Do not attempt to use the oven without the glass being in place.

TO CLEAN THE INNER GLASS DOOR

The inner glass door is not removable. Clean using hot soapy water or Hob Brite and a soft cloth. Take care **NOT** to use abrasives as they may damage the glass or seal.



If the door glass panel becomes chipped or has deep scratches the glass will be weakened and must be replaced to prevent the possibility of the panel shattering. Please contact your local Service Force Centre who will be pleased to advise further.

SOMETHING NOT WORKING?

We strongly recommend that you carry out the following checks on your appliance before calling a Service Engineer. It may be that the problem is a simple one which you can solve yourself without the expense of a Service call.

If our Service Engineer finds that the problem is listed below you will be charged for the call whether or not the appliance is under guarantee.

The appliance does not work at all:

- * Check that the appliance has been wired in and is switched on at the wall.

- * Check that the main appliance fuse is working.

- * Check that the timer instructions have been followed correctly.

The oven temperature is too high or low:

- * Check that the recommended temperatures are being used (see page 20). Be prepared to adjust the temperature up or down by 10°C to achieve the results you want.

The hotplates and fan oven work but the grill does not:

- * Check that you have carefully followed the instructions for operation of the grill.

If the oven is not cooking evenly or the side opening door will not stay open:

- * Check that the appliance is correctly installed and that it is level.

- * Check that the recommended temperatures and shelf positions are being used.

The oven fan is noisy:

- * Check that the oven is level.

- * Check that bake ware and shelves are not vibrating in contact with the back panel in the oven.

SERVICE AND SPARE PARTS

In the event of your appliance requiring service, or if you wish to purchase spare parts, please contact your local Service Force Centre by telephoning:-

0870 5 929929

Your telephone call will be automatically routed to the Service Force Centre covering your post code area.

For the address of your local Service Force Centre and further information about Service Force, please visit the website at www.serviceforce.co.uk.

Before calling out an engineer, please ensure you have read the details under the heading "Something Not Working?".

When you contact the Service Force Centre you will need to give the following details:

1. Your name, address and post code.
2. Your telephone number.
3. Clear and concise details of the fault.
4. The model and serial number of the appliance (found on the rating plate).
5. The purchase date.

Please note that a valid purchase receipt or guarantee documentation is required for in-guarantee service calls.

For Customer Service in Ireland please contact us at the address below:

Tricity Bendix
Electrolux Group (Irl) Ltd
Long Mile Road
Dublin 12
Republic of Ireland

Tel: +353 (0) 1 4090752

Email: service.eid@electrolux.ie

CUSTOMER CARE DEPARTMENT

For general enquires concerning your Tricity Bendix appliance, or for further information on Tricity Bendix products, please contact our Customer Care Department by letter or telephone at the address below;

Customer Care Department
Tricity Bendix
55 – 77 High Street
Slough
Berkshire
SL1 1DZ
Tel: 0870 5 950950 (*)

*calls to this number may be recorded for training purposes.

GUARANTEE CONDITIONS

Standard guarantee conditions

We, Tricity Bendix, undertake that if within 12 months of the date of the purchase this Tricity Bendix appliance or any part thereof is proved to be defective by reason only of faulty workmanship or materials, we will, at our option repair or replace the same FREE OF CHARGE for labour, materials or carriage on condition that:

- The appliance has been correctly installed and used only on the electricity supply stated on the rating plate.
- The appliance has been used for normal domestic purposes only, and in accordance with the manufacturer's instructions.
- The appliance has not been serviced, maintained, repaired, taken apart or tampered with by any person not authorised by us.
- All service work under this guarantee must be undertaken by a Service Force Centre.
- Any appliance or defective part replaced shall become the Company's property.
- This guarantee is in addition to your statutory and other legal rights.

Home visits are made between **8.30am** and **5.30pm** Monday to Friday. Visits may be available outside these hours in which case a **premium** will be charged.

Exclusions

This guarantee does not cover:

- Damage or calls resulting from transportation, improper use or neglect, the replacement of any light bulbs or removable parts of glass or plastic.
- Costs incurred for calls to put right an appliance which is improperly installed or calls to appliances outside the United Kingdom.
- Appliances found to be in use within a commercial environment, plus those which are subject to rental agreements.
- Products of Tricity Bendix manufacture which are not marketed by Tricity Bendix.

European Guarantee

If you should move to another country within Europe then your guarantee moves with you to your new home subject to the following qualifications:

- The guarantee starts from the date you first purchased your product.
- The guarantee is for the same period and to the same extent for labour and parts as exists in the new country of use for this brand or range of products.
- This guarantee relates to you and cannot be transferred to another user.
- Your new home is within the European Community (EC) or European Free Trade Area.
- The product is installed and used in accordance with our instructions and is only used domestically, i.e. a normal household.
- The product is installed taking into account regulations in your new country.

Before you move please contact your nearest Customer Care centre, listed below, to give them details of your new home. They will then ensure that the local Service Organisation is aware of your move and able to look after you and your appliances.

France	Senlis	+33	(0) 3 44 62 20 13
Germany	Nürnberg	+49	(0) 800 234 7378
Italy	Pordernone	+39	(0) 800117511
Sweden	Stockholm	+46	(0) 20 78 77 50
UK	Slough	+44	(0) 1753 219898
Ireland	Dublin	+353	(0) 1 4090752

NOTES

NOTES

NOTES

TRICITY BENDIX

Tricity Bendix, 55-77 High Street, Slough, Berkshire SL1 1DZ

Consumer care telephone number 08705 950950

IMPORTANT NOTICE

In line with our continuing policy of research and development, we reserve the right to alter models and specifications without prior notice.

This instruction booklet is accurate at the date of printing, but will be superseded if specifications or appearance are changed.

SE323 - 311678600

© Electrolux plc 2003

 **From the Electrolux Group.** *The world's No.1 choice.*

The Electrolux Group is the world's largest producer of powered appliances for kitchen, cleaning and outdoor use. More than 55 million Electrolux Group products (such as refrigerators, cookers, washing machines, vacuum cleaners, chain saws and lawn mowers) are sold each year to a value of approx. USD 14 billion in more than 150 countries around the world.