

Start Here

Kodak ESP 3200 Series

All-in-One Printer



Print • Copy • Scan

*Includes Information on the:
ESP 3250 All-in-One Printer
ESP 3260 All-in-One Printer*

Note: A USB 2.0 cable is required to connect your KODAK All-in-One Printer to your WINDOWS or MACINTOSH OS Computer. Available in the KODAK Store or see your local retailer.

1 Unpacking the Printer

Included with your KODAK All-in-One Printer:



Power Cord and Adapter



Printhead

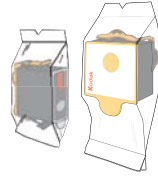

Black & Color Ink Cartridges



Software CD

IMPORTANT: To view a setup video for your printer, go to www.kodak.com/go/inkjetvideo.



- a.** Remove all shipping tape from the outside of the printer.

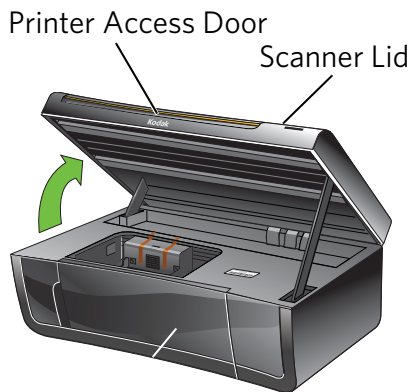

- b.** Lift the printer access door.
- c.** Remove all shipping tape and foam pieces from the inside of the printer.
- d.** Close the printer access door.

2 Connecting the Power

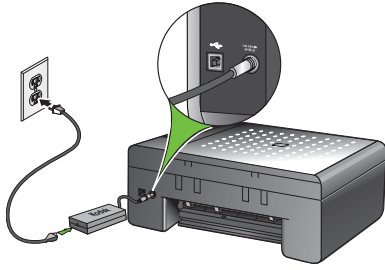

- a. Connect the:
- power cord to the adapter
 - adapter to the printer
 - power cord to the power source



Do not connect the USB cable to the printer until instructed during software install.

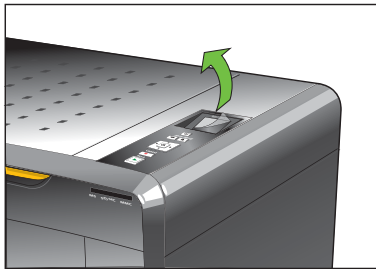

- b. Remove the plastic film from the LCD.

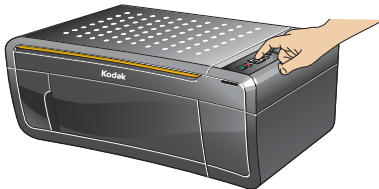

- c. Press ON .
- d. Select your language and press **OK**.

3 Inserting the Printhead

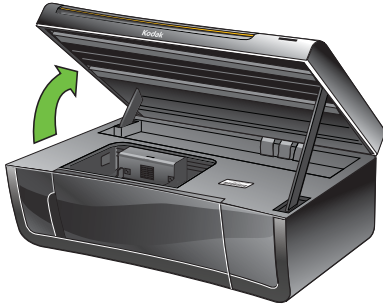

a. Lift the printer access door.

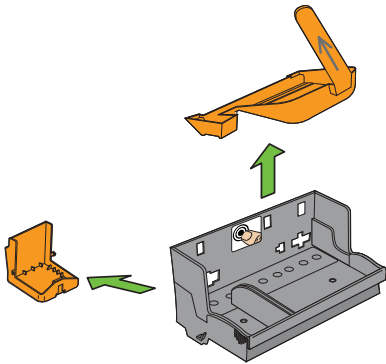

b. Carefully remove the printhead from its bag.

⚠ *Do not touch the copper-colored contacts.*

c. Remove the two plastic protective shields.

Carriage

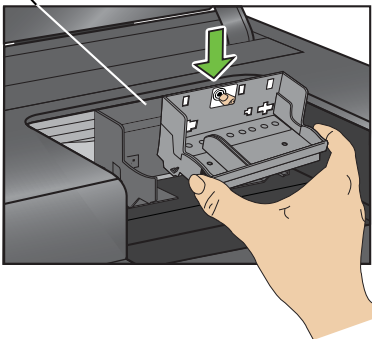

d. Place the printhead into the carriage.
Insert at the angle shown.

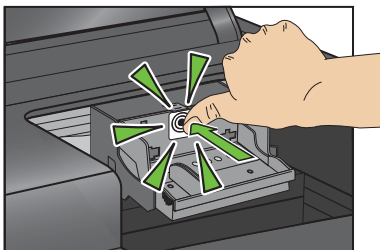

e. Push **firmly** against the target label of the printhead until you hear a **loud snap**.

4 Inserting the Ink Cartridge

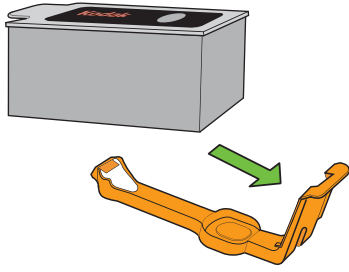

- a. Remove the black ink cartridge from its bag.
- b. Carefully remove and discard the orange cap.

 *Handle ink cartridges carefully to avoid ink transfer.*

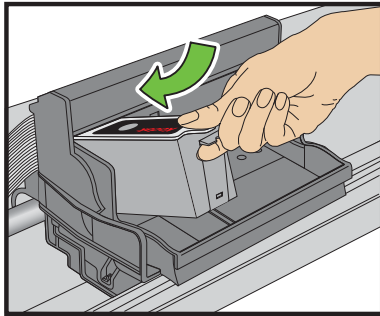

- c. Insert the black ink cartridge into the printhead.

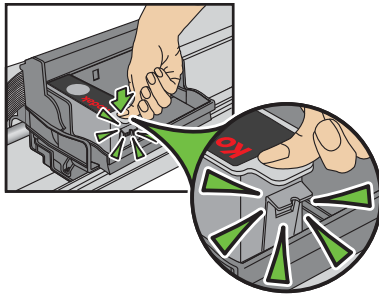

- d. Press down on the ink cartridge until you hear it click into position.
- e. **Repeat** steps 4a - 4d with the **color** ink cartridge.

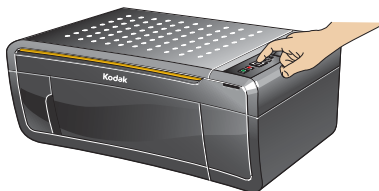

- f. Close the printer access door and press **OK**.

5 Loading Paper and Calibrating

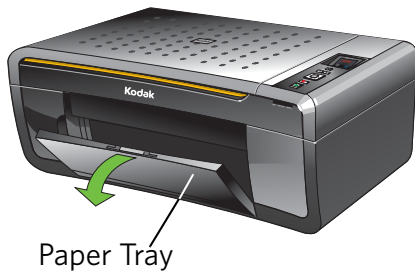

a. Open the paper tray.

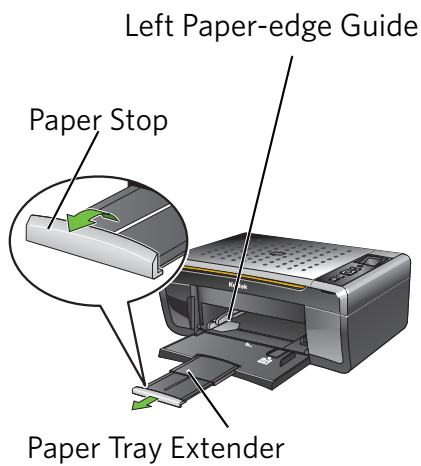

b. Pull out the paper tray extender until it is fully extended.

c. Lift the paper stop.

d. Make sure the left paper-edge guide is to the far left.

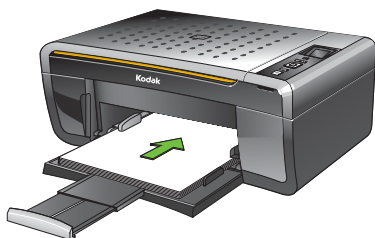

e. Carefully fan and stack the paper, then insert it into the tray.

f. Move the paper forward until it stops.

g. Move the left paper-edge guide until it stops.

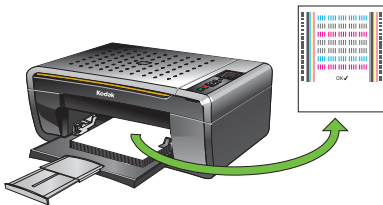

h. Press **Start**. Calibration will take two to three minutes.

6 Installing Software on WINDOWS OS



- a. Load the KODAK All-in-One Printer Software CD into the CD drive. Follow the on-screen instructions.

If the installer window does not open, click **Start**, then click **Computer** or **My Computer**, and double-click the CD drive.

NOTE: If your computer does not have a CD drive, go to www.kodak.com/go/downloads to download the software.

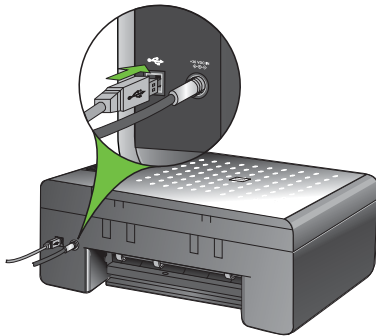

- b. Connect the USB cable to the USB port on the printer and to your computer. Continue to follow the on-screen instructions until installation is complete.

KODAK Home Center Software for WINDOWS OS



KODAK Home Center is installed with your KODAK All-in-One Printer Software. The Home Center icon will appear on your desktop. You can use it to browse and edit pictures, print, copy, scan, order supplies, access the User Guide, and configure your all-in-one printer from your computer.

7

Installing Software on MACINTOSH OS

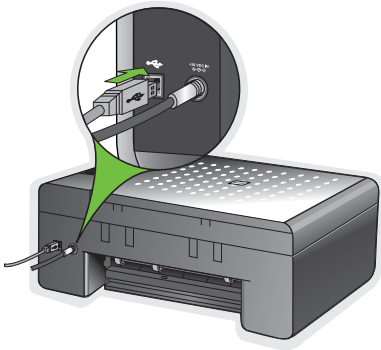

- a. Connect the USB cable to the USB port on the printer and to your MACINTOSH Computer.
- b. Load the KODAK All-in-One Printer Software CD into the CD drive. Follow the on-screen instructions.

If the installer window does not open, double-click the KODAK All-in-One Printer Software CD icon on the desktop.



KODAK Home Center Software for MACINTOSH OS



KODAK Home Center is installed with your KODAK All-in-One Printer Software. The Home Center icon will appear on your desktop. You can use it to order supplies and configure your all-in-one printer from your computer.

Warranty Information

Limited Warranty

Kodak warrants Kodak consumer electronic products and accessories (“Products”), excluding batteries, to be free from malfunctions and defects in both materials and workmanship for one year from the date of purchase. Retain the original dated sales receipt. Proof of the date of purchase will be required with any request for warranty repair.

Limited Warranty Coverage

Warranty service is only available from within the country where the Products were originally purchased. You may be required to send Products, at your expense, to the authorized service facility for the country where the Products were purchased. Kodak will repair or replace Products if they fail to function properly during the warranty period, subject to any conditions and/or limitations stated herein. Warranty service will include all labor as well as any necessary adjustments and/or replacement parts. If Kodak is unable to repair or replace a Product, Kodak will, at its option, refund the purchase price paid for the Product provided the Product has been returned to Kodak together with proof of the purchase price paid. Repair, replacement, or refund of the purchase price are the sole remedies under this warranty. If replacement parts are used in making repairs, those parts may be remanufactured or may contain remanufactured materials. If it is necessary to replace the entire Product, it may be replaced with a remanufactured Product. Remanufactured Products, parts and materials are warranted for the remaining warranty term of the original Product, or 90 days after the date of repair or replacement, whichever is longer.

Limitations

This warranty does not cover circumstances beyond Kodak’s control. This warranty does not apply when failure is due to shipping damage, accident, alteration, modification, unauthorized service, misuse, abuse, use with incompatible accessories or attachments (such as third party ink or ink tanks), failure to follow Kodak’s operation, maintenance or repacking instructions, failure to use items supplied by Kodak (such as adapters and cables), or claims made after the duration of this warranty. KODAK MAKES NO OTHER EXPRESS OR IMPLIED WARRANTY FOR THIS PRODUCT, AND DISCLAIMS THE IMPLIED WARRANTIES AND CONDITIONS OF MERCHANTABILITY AND FITNESS FOR A PARTICULAR PURPOSE. In the event that the exclusion of any implied warranty is ineffective under the law, the duration of the implied warranty will be one year from the purchase date or such longer period as required by law. The option of repair, replacement, or refund is Kodak’s only obligation. Kodak will not be responsible for any special, consequential or incidental damages resulting from the sale, purchase, or use of this product regardless of the cause. Liability for any special consequential or incidental damages (including but not limited to loss of revenue or profit, downtime costs, loss of the use of the equipment, cost of substitute equipment, facilities or services or claims of your customers for such damages resulting from the purchase, use or failure of the Product), regardless of cause, or for breach of any written or implied warranty is expressly disclaimed.

Your Rights

Some states or jurisdictions do not allow exclusion or limitation of incidental or consequential damages, so the above limitation or exclusion may not apply to you. Some states or jurisdictions do not allow limitations on how long an implied warranty lasts, so the above limitation may not apply to you. This warranty gives you specific rights, and you may have other rights which vary from state to state or by jurisdiction. Your statutory rights are not affected.

Outside the United States and Canada

In countries other than the United States and Canada, the terms and conditions of this warranty may be different. Unless a specific Kodak warranty is communicated to the purchaser in writing by a Kodak company, no warranty or liability exists beyond any minimum requirements imposed by law, even though defect, damage, or loss may be by negligence or other act.

Safety Information

- Read and follow these instructions before using KODAK Products.
- Always follow basic safety procedures.
- Follow all warnings and instructions marked on the equipment.

Warning Statements

- Do not expose this product to liquid, moisture, or extreme temperatures. KODAK AC Adapters are intended for indoor use only. The use of controls, adjustments, or procedures other than those specified herein may result in exposure to shock and/or electrical or mechanical hazards.
- Keep ink cartridges out of reach of children. Ink may be harmful if swallowed.
- Do not place your all-in-one printer on an unstable cart, stand, bracket, or table. Injury to persons and damage to the equipment may occur.
- The use of an accessory attachment that is not recommended by Kodak, such as an AC adapter, may cause fire, electric shock, or injury.
- Pushing objects through the equipment openings can result in an electric shock or risk of fire.

Cautionary Statements

- Adjust only those controls covered in the operating instructions.
- Do not disassemble this product; there are no user-serviceable parts inside. Refer servicing to qualified service personnel.
- The AC adapter power supply is equipped with 3-wire grounding type plugs. If you cannot insert the plug into the power outlet, contact an electrician to check or replace the power outlet.
- Do not plug the AC adapter into a household extension cord.
- If the power cord or plug is frayed or damaged, the equipment gets wet, or the equipment does not operate normally when the operating instructions are followed, unplug your printer from the power outlet and contact Kodak at www.kodak.com/go/contact for further instructions.
- For added protection from damage during a lightning storm, or any time when your printer and its associated AC adapter will be left unused for long periods of time, unplug the AC adapter from the power outlet and any attached fax line from the printer.
- To prevent your printer from overheating, do not place it near a heat register, or install it in a cabinet without proper ventilation.
- Do not use your printer near water or spill liquid on it.
- Unplug the equipment from the wall outlet before cleaning.
- Dropping your printer may damage the housing and result in extensive damage that will require repair by a qualified technician to restore normal operation.
- Excessive dust levels may damage internal parts.

For more information, go to www.kodak.com/go/MSDS.



Registration has its rewards—including a terrific offer.

Register your KODAK All-in-One Printer and get great support, expert tips, free software downloads—**plus a phenomenal deal on inkjet supplies to get you started**. Simply register right away when prompted during software installation or on the Web at www.kodak.com/go/register. Registration takes a minute—but the rewards are lasting.

Inkjet supplies offer valid for U.S. residents only.

Thank you for purchasing a KODAK All-in-One Printer.
In the unlikely event that your printer does not operate as expected,
please do not return it to the store.

Do the following steps to begin troubleshooting.



1. Power cycle the printer by unplugging the printer. Wait five seconds, and then plug the power cord back into the printer.



2. Confirm that you are using a USB 2.0 cable. You can purchase a USB 2.0 cable online at www.kodak.com/go/usbcable or at your local retailer.



3. Make sure that you have the most up-to-date software and firmware. Go to www.kodak.com/go/downloads to download the latest files.

For additional assistance:



Go to www.kodak.com/go/aiosupport, select your printer, and view Frequently Asked Questions (FAQs), Step-by-Step Solutions and Repairs, User Guides, and more.

Kodak

Eastman Kodak Company
Rochester, NY 14650 U.S.A.
© Eastman Kodak Company, 2009
MC/MR/TM: Kodak.



1K5812

Printed in
Windows® is a registered trademark of Microsoft Corporation.
Macintosh® is a registered trademark of Apple Inc.