

Start Here

1 Important setup information

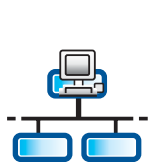

Wireless or wired network users: you must follow the instructions in this setup guide to be successful adding the HP All-in-One to your network.



USB cable users: Do not connect the USB cable until step A2.

2 Remove all tape and lift display

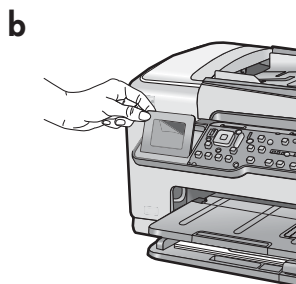
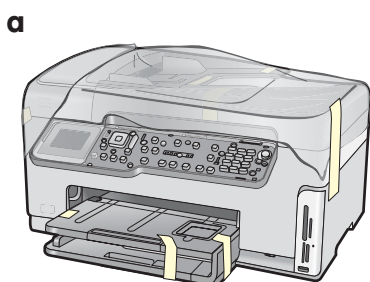

- a Remove all tape and protective film from the lid and from the front, back, and both sides of the device.
- b Lift the color graphics display and remove the protective film. You can adjust the height of the display to a position suitable for viewing.

3 Locate components



Windows CD



Mac CD



Documentation CD
This CD may be included for some languages where help is not available through the software.

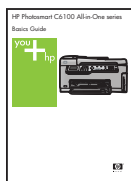

Basics Guide



4 x 6 in
(10 x 15 cm) photo paper

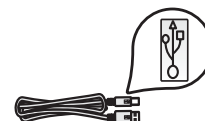

USB cable *



adapter

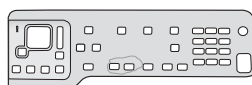

control panel faceplate
(may be pre-attached)



Ethernet cable *

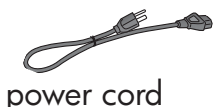

power cord

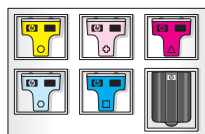

ink cartridges



phone cord

* May need to be purchased separately.

The contents of your box may differ.

4

Attach the control panel faceplate (if not attached)

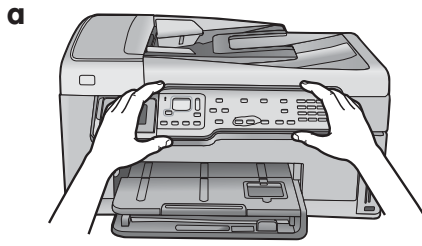

a Position the control panel faceplate over the buttons on the device.

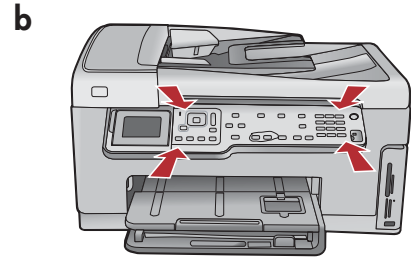

b Press down **firmly** on all edges of the faceplate until it **snaps** into place. Make sure all buttons come through the holes in the faceplate.

5

Load paper into bottom tray

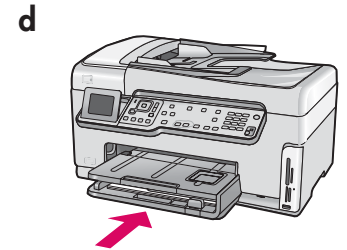
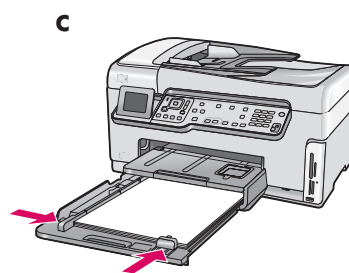
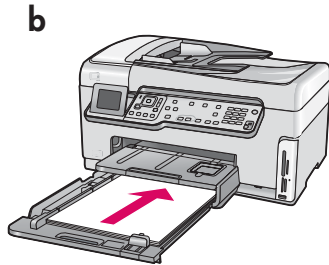
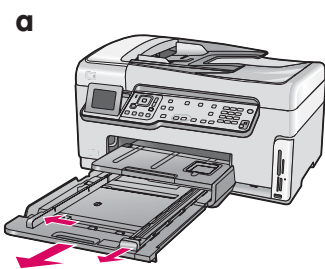

Load plain white paper in the bottom paper tray. Plain paper is needed for alignment.

6

Load photo paper

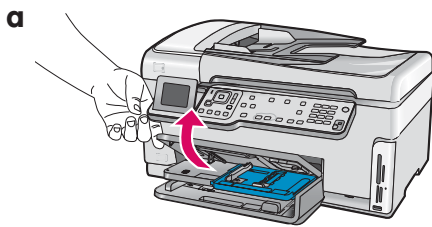

a Lift the output tray.

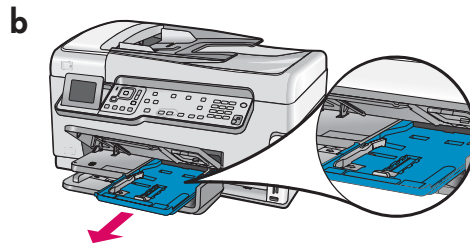

b Pull out the photo tray.

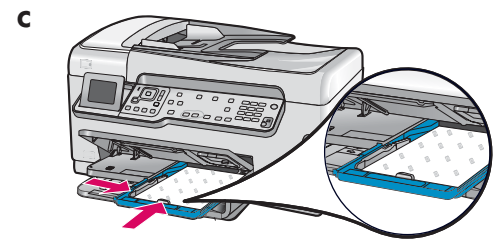

c Load the 4 x 6 inch (10 x 15 cm) photo paper from the sample pack with the glossy side down in the photo tray.

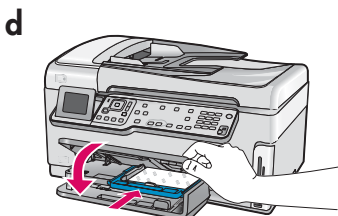

d Lower output tray and push in the photo tray.

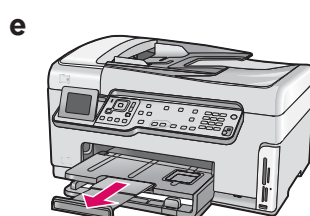

e Pull out the tray extender and lift up the paper catch.



Tip: If the paper is tabbed, make sure the tab is towards you.

7

Connect the supplied phone cord

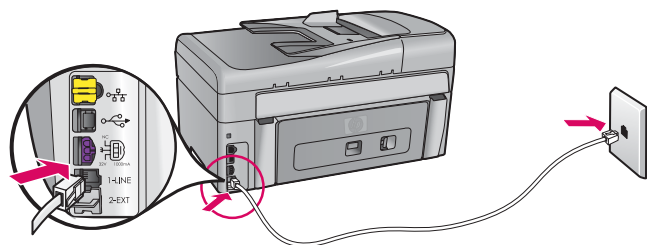

Connect one end of the supplied phone cord to the port labelled **1-LINE** and the other to a wall jack.

See the Basics Guide if you want to use your own phone cord or for help with other fax setup options.

8

Connect the power cord and adapter

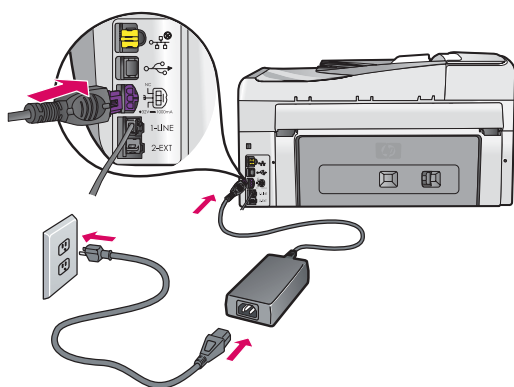

USB cable users: Do not connect the USB cable until instructed later in this guide.

9

Press the On button

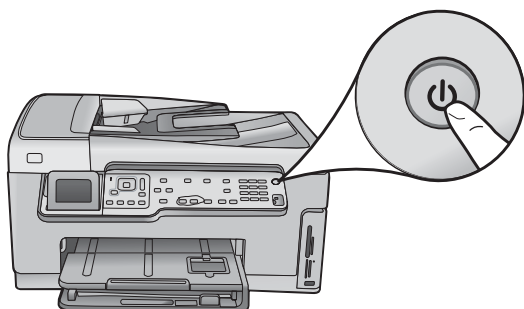

After you press the **On** button, wait for the prompt on the color graphics display before continuing.

10

Open the access door

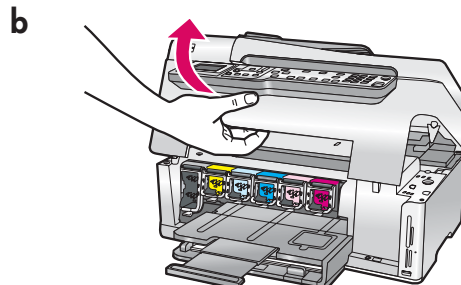
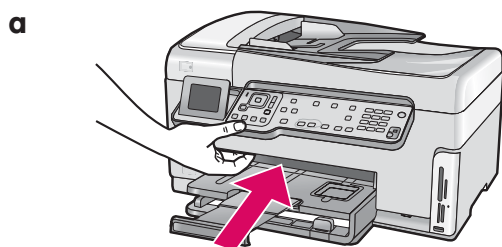

11

Lift latches inside of the device

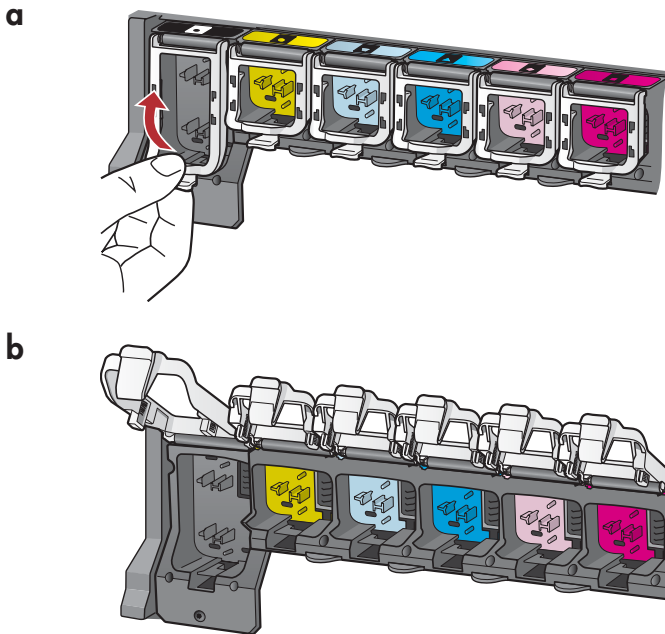

- a Squeeze the bottom of each latch to release it, and then lift the latch.
- b Lift all six latches.

12

Insert all six ink cartridges

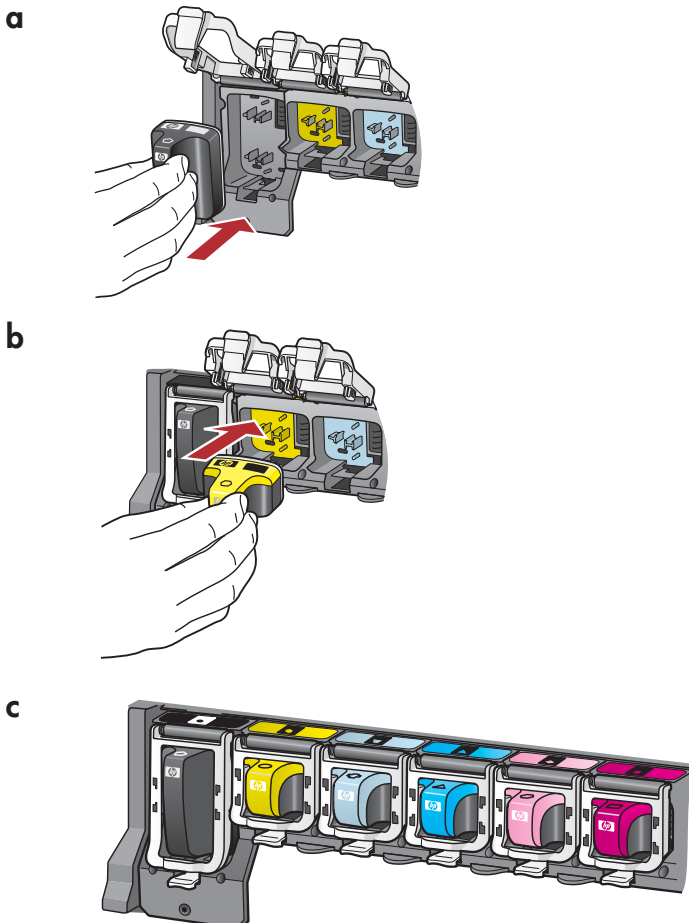

Match the color and pattern of the ink cartridge to the color and pattern on the print carriage.

- a Push the black ink cartridge in to the first slot on the left. Close the latch.
- b Repeat with each of the color ink cartridges.
- c Make sure each latch is secure.

Note: Use only the ink cartridges that came with the printer. The ink in these cartridges is specially formulated to mix with the ink in the print head assembly at first-time setup.

13 Close the access door and follow the prompts

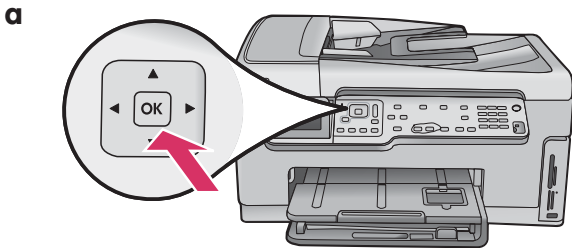

- a After you close the access door, a prompt appears to load plain white paper. Make sure paper is loaded, and then press **OK** to start the process. The device initializes the ink cartridges and aligns the printer. This takes approximately 5 minutes.

CAUTION: Do not disconnect or turn off the HP All-in-One during this time. You may hear the device making noises.

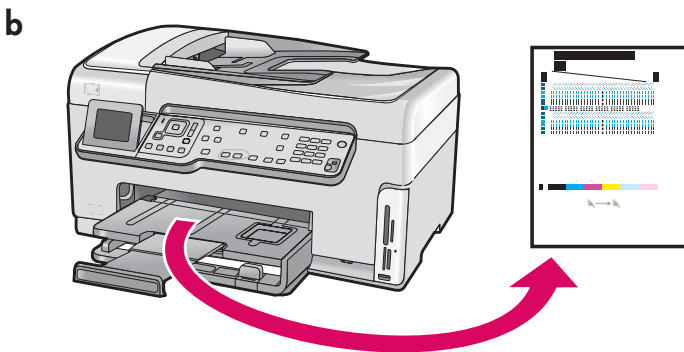

- b After the alignment page is printed, alignment is complete. Check the display for status, then press **OK**. Recycle or discard the alignment page.

14 Connect the HP All-in-One

Continue to the next page for instructions on connecting your HP All-in-One to your computer or your network.

A: USB Connection - Do not connect yet

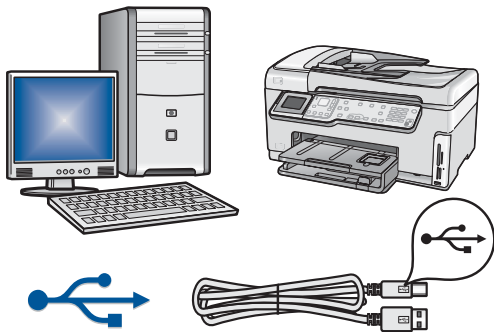

Use this connection type if you want to connect the HP All-in-One directly to one computer. **(Do not connect the USB cable until step A2).**

Equipment needed: USB cable.

For a USB connection, go to Section A (page 7) for instructions.

B: Ethernet (Wired) Network

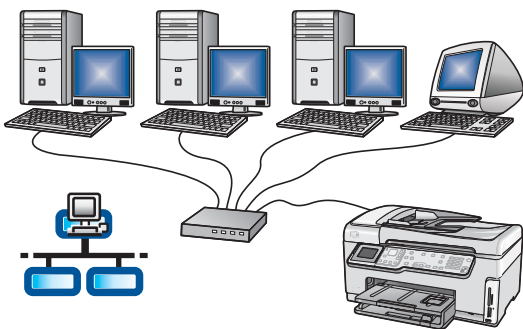

Use this connection type if you want an Ethernet cable connection between the HP All-in-One and your network.

Equipment needed: router and Ethernet cable.

For an Ethernet cable connection, go to Section B (page 9) for instructions.

C: Wireless Network

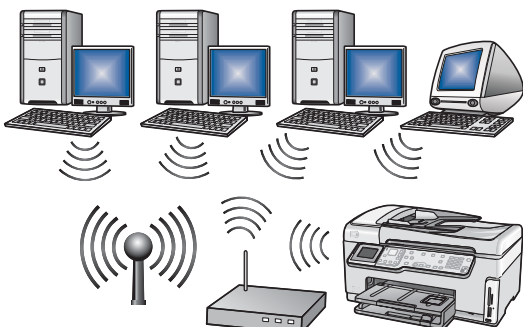

Use this connection type if you want a wireless (802.11 b or g) connection between the HP All-in-One and your network. Equipment needed: wireless router*.

For a wireless network connection, go to Section C1 (page 11) for instructions.

***Note:** If you do not have a wireless router, but want to connect your wireless computer to the HP All-in-One, see the **Wireless Ad Hoc Network Setup** section in the Basics Guide.



Section A: USB Connection

A1 Choose the correct CD

Windows Users:

- Turn on your computer, login if necessary, and then wait for the desktop to appear
- Insert the HP All-in-One **Windows** CD..

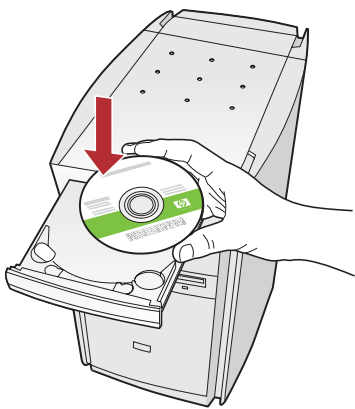

Note: If the startup screen does not appear, double-click **My Computer**, double-click the **CD-ROM** icon with the HP logo, and then double-click **setup.exe**.

- Follow the onscreen instructions to install the software.
- On the **Connection Type** screen, make sure to select **directly to this computer**. Continue to the next page.
- Continue to the next page.

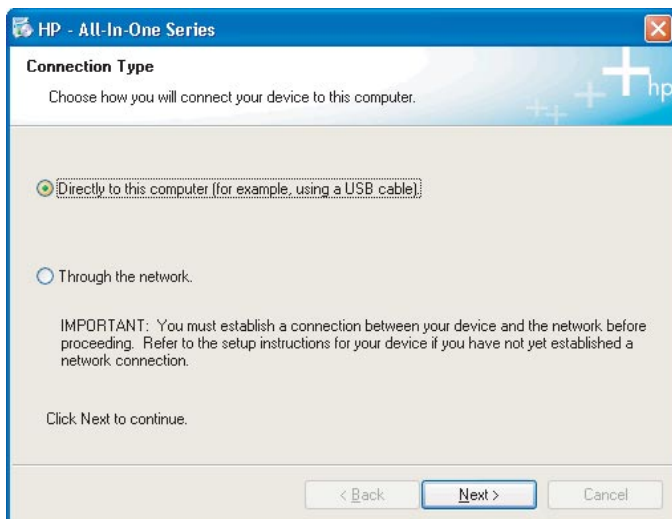

Mac Users:

- Turn on your computer, login if necessary, and then wait for the desktop to appear.



- Locate the HP All-in-One **Mac** CD.
- Continue to the next page.

A2 Connect the USB cable

Windows Users:

- a Follow the onscreen instructions until you see the prompt to connect the USB cable. (This may take several minutes.)

Once the prompt appears, connect the USB cable to the port on the back of the HP All-in-One, and then to **any USB port** on your computer.

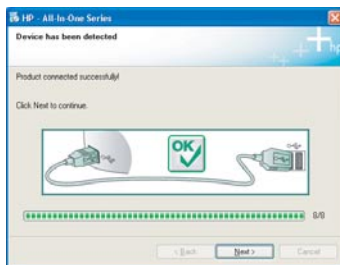
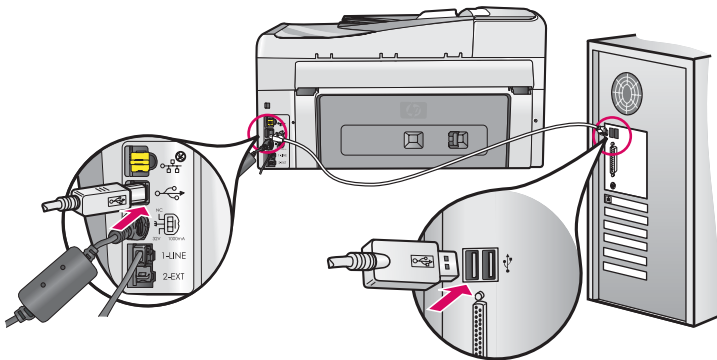

- b Follow the onscreen instructions to complete the software installation.

Mac Users:

- a Connect the USB cable from your computer to the USB port on the back of the device.

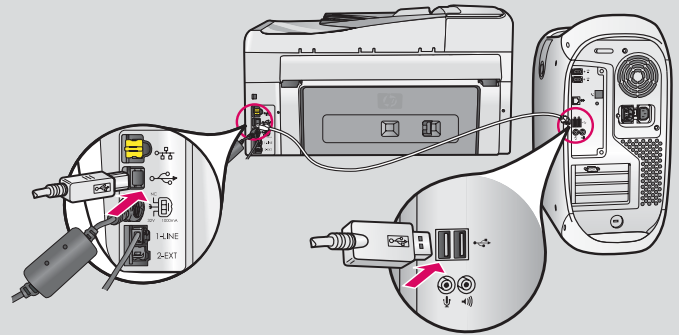

- b Double-click the **HP All-in-One Installer** icon.
- c Make sure you complete all screens, including the Setup Assistant.

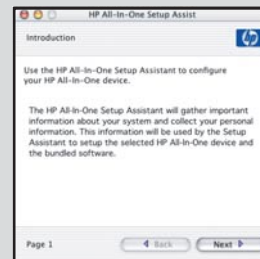

A3 Congratulations! Go to step 18 of this Setup Guide



Section B: Ethernet (wired) network

B1 Connect the Ethernet cable

b

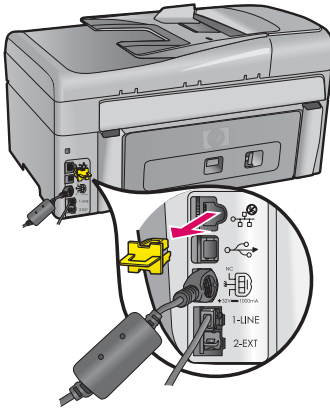

- a Locate the Ethernet cable that you may have purchased separately.
- b Remove the yellow plug from the back of the device.
- c Connect one end of the Ethernet cable to the Ethernet port on the back of the device.
- d Connect the other end of the Ethernet cable to the router.

c

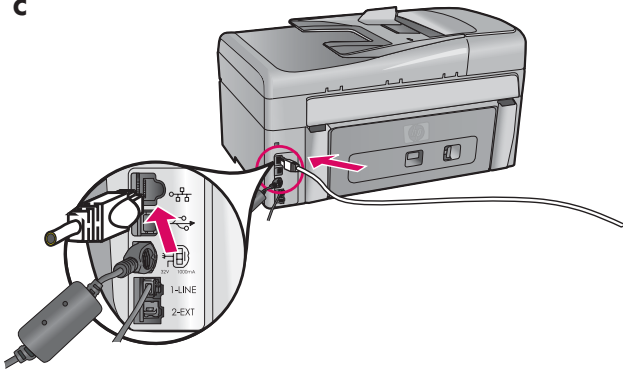

Important: Your computer and the HP All-in-One must be on the same active, working network. If you are using a DSL or cable modem, make sure you do not connect the Ethernet cable from the HP All-in-One to the cable modem. Connect it to the router only.

d

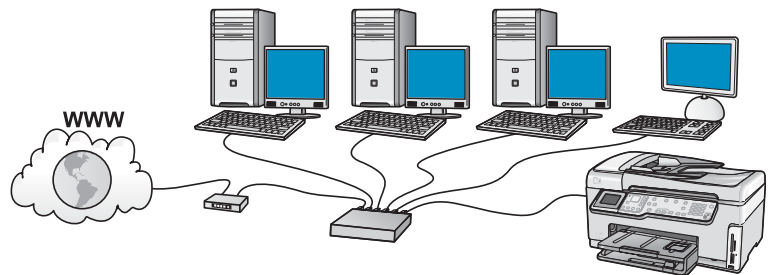
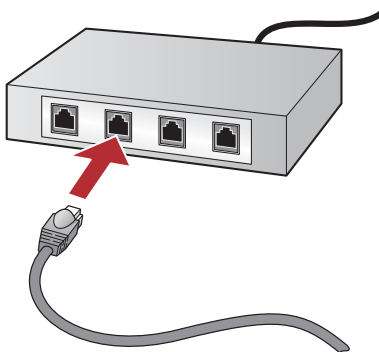

B2

Choose the correct CD

Windows Users:

- a Turn on your computer, login if necessary, and then wait for the desktop to appear.
- b Insert the HP All-in-One CD

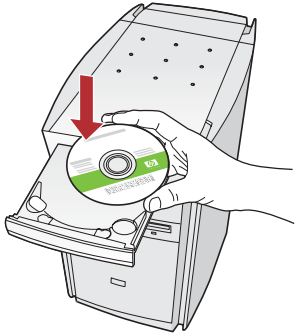

Note: If the startup screen does not appear, double-click **My Computer**, double-click the **CD-ROM** icon with the HP logo, and then double-click **setup.exe**.

- c Follow the onscreen instructions to install the software.
- d On the **Connection Type** screen, make sure to select **through the network**. Follow the onscreen instructions.

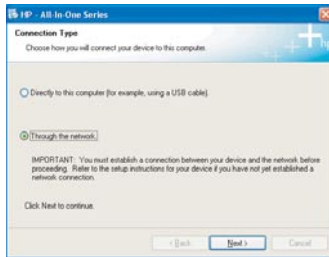

- e Your firewall software may provide prompts on your computer warning you that HP software is attempting to access your network. You should respond to these prompts so that access is "always" allowed. Then continue with the HP software installation.
- f Continue to the next page.

Questions: Anti-virus and anti-spyware applications may block software installation and may need to be disabled. Remember to turn them back on again following installation.

Mac Users:

- a Turn on your computer, login if necessary, and then wait for the desktop to appear.

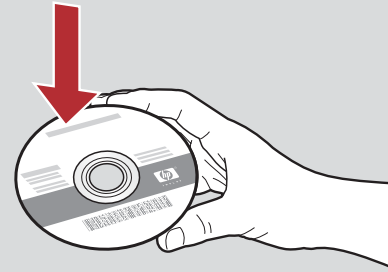

- b Insert the HP All-in-One **Mac** CD.
- c Double-click the **HP All-in-One installer** icon.



- d Make sure you complete all screens, including the Setup Assistant. To install software on additional computers, go to step 14.

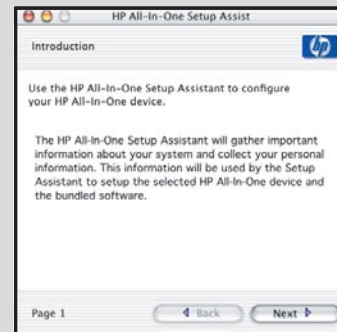

B3

Congratulations! Go to step 16 of this setup guide



Section C: Wireless Network

C1 Choose ONE wireless network option (A or B)

You have two options for connecting the HP All-in-One to your wireless network. You must choose one or the other:

- If you are **certain** that your network was originally set up using SecureEasySetup, go to **Option A: SecureEasySetup** in Section C2, below.
- If you are not certain, then go to **Option B: Typical Wireless Setup (Recommended)** in section C2, which is on the next page.



Tip: If you are unable to establish a wireless network connection to your HP device, you can connect to your network using an Ethernet cable or connect directly to your computer using a USB cable.

C2 Establish the wireless connection

Option A: SecureEasySetup

Requirements: You must have a wireless router that supports SecureEasySetup.

IMPORTANT: Use this method only if you have previously used SecureEasySetup to setup your network. Otherwise your network settings may be reset.

- a** Put the wireless router in SecureEasySetup mode. This often involves pressing a button on the wireless router.

IMPORTANT: You may have limited time to complete the next step after putting the wireless router into SecureEasySetup mode. See the documentation that came with the wireless router for information about SecureEasySetup.

- b** Press the **Setup** button on the HP All-in-One.

- c** Press ▼ until **Network** is highlighted, and then press **OK**. The Network Menu appears.

- d** Press ▼ to highlight **Wireless Setup Wizard**, and then press **OK**.

The network should be detected automatically and the wireless network connection will be established.

If the wireless connection is not established or you see the Select Network Name screen, it is likely that you ran out of time after putting the wireless router in SecureEasySetup mode. Put your wireless router into SecureEasySetup mode again, and then rerun the Wireless Setup Wizard.

- e** Follow the prompts on the display to complete the network setup. **If the connection is successful, go to step C3.**

If you have problems connecting to the network, see the Basics Guide for additional setup information.

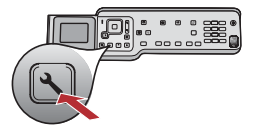

Option B: Typical Wireless Setup (Recommended)

- a Locate and write down your wireless router settings.

Network Name (also called SSID): _____

WEP key/WPA Passphrase (if needed): _____

IMPORTANT: If you do not know this information, you cannot continue with your wireless setup. To obtain the necessary information, you must consult the documentation for your wireless router, the router manufacturer, or the person who originally set up your wireless network. As much as HP would like to help you, HP is unable to answer questions about your wireless router or your network such as the Network Name, WEP key, or WPA passphrase.

- b Press the **Setup** button on the HP All-in-One.

- c Press ▼ until **Network** is highlighted, and then press **OK**. The Network Menu appears.

- d Press ▼ to highlight **Wireless Setup Wizard**, and then press **OK**.

In a few moments, a list of detected networks appears on the display. The network with the strongest signal appears first.

- e Do one of the following:

- Press ▼ to highlight the name of the network that you wrote down earlier, and then press **OK**.
- If the network name that you wrote down does not appear in the list, you can enter it manually. Press ▼ to highlight **Enter New Network Name (SSID)** and then press **OK**. See Display keyboard tips to enter text.

- f If your network uses security, a prompt appears for the WEP key or WPA passphrase. Both are case sensitive. Type the WEP key or WPA passphrase, as requested. See Display keyboard tips to enter text. If the WEP key or WPA passphrase is not accepted, refer to **Network Troubleshooting** on page 15.

Note: If your router provides 4 WEP keys, make sure you use the first one.

- g Follow the prompts on the display to complete the network setup. **If the connection is successful, go to step C3.**

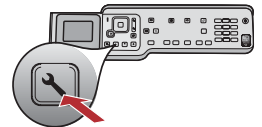

Display keyboard tips:

To Select: use Arrow keys to highlight, and then press **OK**.

For mistakes: Select **Clear**. Tip: If the **Clear** button does not appear, select **abc** to display it.

For lowercase: Select **abc**

For numbers: Select **123**

When you are finished: Highlight **Done**, and then press **OK**.



If you have problems connecting to the network, see the Basics Guide for additional setup information.

Windows Users:

- Turn on your computer, login if necessary, and then wait for the desktop to appear.
- Insert the HP All-in-One **Windows** CD

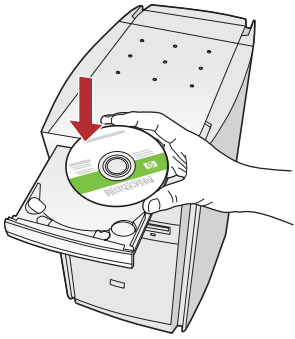

Note: If the startup screen does not appear, double-click **My Computer**, double-click the **CD-ROM** icon with the HP logo, and then double-click **setup.exe**.

- Follow the onscreen instructions to install the software.
- On the **Connection Type** screen, make sure to select **through the network**. Follow the onscreen instructions.



- Your firewall software may provide prompts on your computer warning you that HP software is attempting to access your network. You should respond to these prompts so that access is "always" allowed. Then continue with the HP software installation.

Questions: Anti-virus and anti-spyware applications may block software installation and may need to be disabled. Remember to turn them back on again following installation.

Mac Users:

- Turn on your computer, login if necessary, and then wait for the desktop to appear.

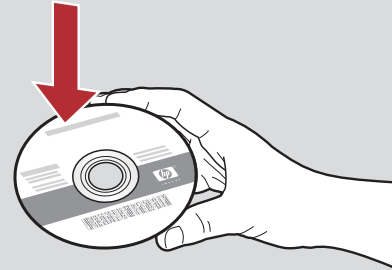

- Insert the HP All-in-One **Mac** CD.
- Double-click the **HP All-in-One installer** icon.



- Make sure you complete all screens, including the Setup Assistant. To install software on additional computers, go to step 14.

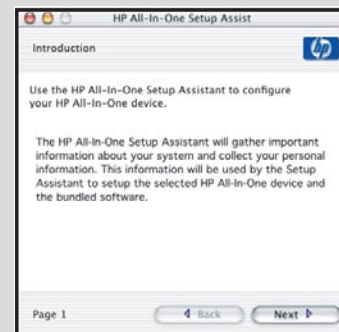

16

Install software on additional computers

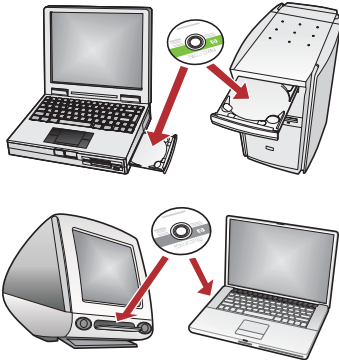

If you have additional computers on your network, install the HP All-in-One software on each computer. Choose the correct HP All-in-One CD for each installation.

Follow the onscreen instructions. Make sure that you choose the connection types between the network and your HP All-in-One (not between your computer and the network).

17

Go to step 18 at the back of this setup guide

Troubleshooting

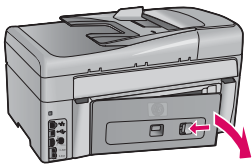

Problem: A **Paper Jam** message appears.

Action: Remove the back access door, and then gently pull out any paper. Turn the device off, and then on. Load the paper again.



Problem: You did not see the screen prompting you to connect the USB cable.

Action: Remove, and then re-insert the HP All-in-One **Windows** CD. Refer to Section A.

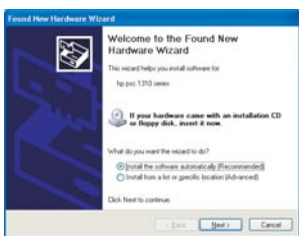

Problem: The Microsoft **Add Hardware** screen appears.

Action: Click **Cancel**. Unplug the USB cable, and then insert the HP All-in-One **Windows** CD. Refer to Section A.

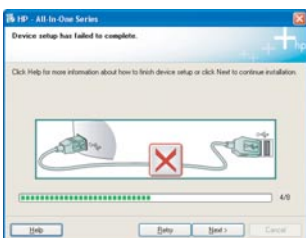

Problem: The **Device Setup Has Failed To Complete** screen appears.

Action: Verify that the control panel faceplate is firmly attached. Unplug the HP All-in-One and plug it in again. Check all connections. Make sure the USB cable is plugged into the computer. Do not plug the USB cable into a keyboard or non-powered hub. Refer to Section A.

Network Troubleshooting



Problem: You are not sure if your network is set up properly.

Action: For information on how to set up a network, go to www.hp.com/support. Enter **Photosmart C6100**, and then search for **Network Setup**.

Problem: You are trying to set up a wireless connection through the control panel, and the HP All-in-One does not connect to the network.

Action:

- On the wireless router, turn on broadcast network name options, and turn off silent broadcast name.
- Move the wireless router closer to the HP All-in-One and make sure there are no obstructions.
- Turn the wireless router off, wait 30 seconds, and then on again.
- Make sure you entered the correct wireless communication mode and authentication type. See steps **C1** through **C3**.
- See the Basics Guide for more details and troubleshooting information.

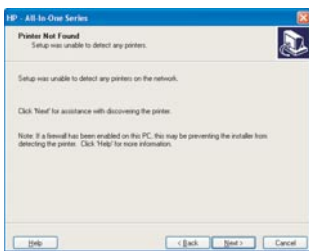

Problem: The **Printer Not Found** message appears.

Action: First make sure that you have an active connection with the HP All-in-One. Check your color graphics display for an icon. If you do not see an icon, go back to your connection type Section (B or C).

If you have an active connection, try the following:

- Turn the HP All-in-One off, wait 30 seconds, and then turn it back on.
- Try temporarily disconnecting your firewall.

Wired (Ethernet) network users:

- Check the cable between the router and the HP All-in-One.
- Check the cable between your computer and the HP All-in-One.
- Make sure your LAN card is set up properly.

Problem: An invalid WEP key or WPA passphrase. This problem could be caused by typing incorrectly, by changing the case of the key or passphrase or by inserting blank spaces at the beginning or end.

Action: Rerun the Wireless Setup Wizard, and type in the WEP key or WPA passphrase correctly, making sure there are no blank spaces at beginning or end.

Problem: I have SecureEasySetup, but when I ran the Wireless Setup Wizard, a list of available networks appeared or the Select Network Name screen appeared.

Action: It is likely that you ran out of time after putting the wireless router in SecureEasySetup mode. Put your wireless router into SecureEasySetup mode again, and then rerun the Wireless Setup Wizard.

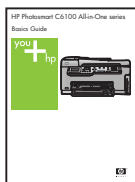

See the Basics Guide for more troubleshooting and additional set up information.

18 Print a 4 x 6 inch photo

a

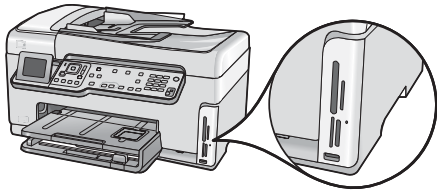

- a Insert the memory card from your camera into the appropriate memory card slot and press the **Photosmart Express** button.

The Photosmart Express menu appears on the color graphics display.

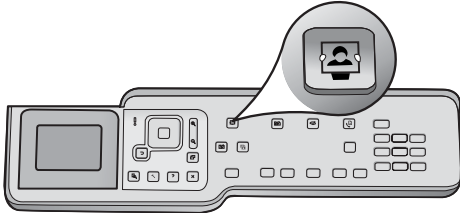

- b Press **OK** to select **View & Print**. The most recent photo on your memory card appears on the display.

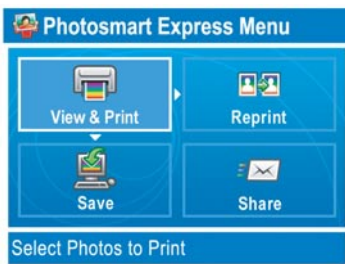

c

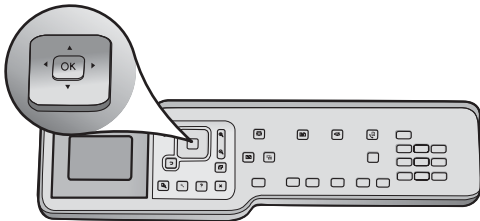

- c Press the arrow buttons to view the desired photo.

d

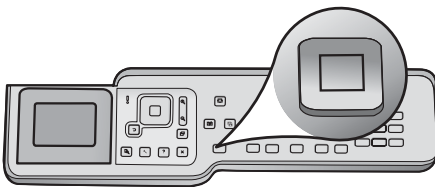

- d Keep pressing **OK** to print your photo.

If you are looking at a photo on the display, you could quickly print a 4 x 6 inch photo by pressing the **Print Photos** button.

The HP All-in-One makes a print of the photo on your memory card.



Tip: You could use the Reprint button to make a copy of an original photo.



Tip: To learn about printing photos from memory cards, and other features, see the User Guide and online help. For additional help, see www.hp.com/support.

