

User Manual



Tektronix

MTM400
MPEG Transport Stream Monitor
071-1224-04

Table of Contents

General Safety Summary	vii
Service Safety Summary	ix
Preface.....	xi
Related Material.....	xii
Manual Conventions	xiii

Getting Started

Overview.....	1-1
Accessories	1-2
Installing the MTM400	1-8
Powering Up the MTM400.....	1-13
The Remote User Interface	1-14

Operating Basics

Local Indicators	2-2
Remote User Interface	2-3
Using WebMSM	2-12
Using MLM1000	2-12
User Interface Version	2-12
Time Zones	2-13

Reference

Device View.....	3-1
Device Status	3-2
View Device Log	3-4
Device Configuration.....	3-6
Device Information	3-15
SNMP.....	3-16
Stream View	3-17
Monitoring Overview Screen (Summary Screen).....	3-20
Detail Screen.....	3-22
Tests Screen	3-23
Custom Screen	3-26
Information Screen.....	3-28
Programs Screen	3-30

PIDs Screen	3-34
PID Groups Screen.....	3-41
PCR Jitter Screen	3-48
SFN Screen.....	3-56
TMCC Screen.....	3-57
SI Graphs Screen.....	3-58
SI Tables Screen.....	3-62
Template.....	3-68
Recording	3-71
Log Screen	3-72
Configuration Screen	3-76
Service Log	3-80
MTM400 Configuration Files	3-85
Scheduling.....	3-91
Scheduling Activities	3-93
Triggered Recording.....	3-99
Triggered Recording Settings.....	3-100
Pre-Trigger Recordings	3-102
Triggered Recording Operation	3-103
Interface Configuration and Interpretation	3-107
QPSK (L-Band).....	3-109
QAM (Annex A and Annex C)	3-114
QAM (Annex B II).....	3-118
COFDM.....	3-122
8VSB	3-126
8PSK (Phase Shift Keying).....	3-129
SMPTE310 Settings	3-132
ASI Settings	3-132

Appendices

Appendix A: Network Installation	A-1
MAC Address	A-2
IP Address	A-3
Resetting the IP Address	A-3
Network Set-Up	A-7
Network Naming.....	A-8
Network Latency.....	A-8
Appendix B: Maintenance.....	B-1
Preventative Maintenance	B-1
Rack Mounting.....	B-2

Glossary

Index

List of Figures

Figure 1-1: MTM400 connectors (shown with QPSK interface).....	1-9
Figure 1-2: Logging on.....	1-15
Figure 1-3: Hotspot view.....	1-16
Figure 1-4: Summary view.....	1-16
Figure 2-1: Front panel.....	2-2
Figure 2-2: RUI overview.....	2-3
Figure 2-3: Hotspot view.....	2-4
Figure 2-4: Device view.....	2-5
Figure 2-5: Stream view.....	2-6
Figure 2-6: Combined view.....	2-9
Figure 2-7: Multiple view.....	2-10
Figure 2-8: Time zones - illustration.....	2-13
Figure 3-1: Device view.....	3-1
Figure 3-2: Device view - Status.....	3-2
Figure 3-3: Device view - Log.....	3-4
Figure 3-4: Device view - Configuration.....	3-6
Figure 3-5: Device view - Information.....	3-15
Figure 3-6: Stream view.....	3-17
Figure 3-7: Stream view - Overview.....	3-20
Figure 3-8: Stream view – Detail.....	3-22
Figure 3-9: Stream view - Tests.....	3-23
Figure 3-10: Stream view - Custom.....	3-26
Figure 3-11: Stream view - Information.....	3-28
Figure 3-12: Stream View - Programs.....	3-30
Figure 3-13: Stream view - PIDs.....	3-34
Figure 3-14: Stream view - PID groups.....	3-41
Figure 3-15: Stream view - PCR graph - PCR inaccuracy.....	3-50
Figure 3-16: Stream view - PCR graph - PCR arrival.....	3-51
Figure 3-17: Stream view - PCR graph - PCR overall jitter.....	3-52
Figure 3-18: Stream view - PCR graph - PCR frequency offset.....	3-53
Figure 3-19: Stream view - PCR graph - PCR drift rate.....	3-54
Figure 3-20: Stream view - PCR graph - PTS arrival.....	3-55
Figure 3-21: Stream view - SFN screen.....	3-56
Figure 3-22: Stream view - TMCC screen.....	3-57
Figure 3-23: Stream view - SI graphs screen - Example.....	3-58
Figure 3-24: DVB SI Tables dialog.....	3-63

Figure 3-25: ATSC SI Tables dialog.....	3-63
Figure 3-26: ISDB-T SI Tables dialog.....	3-64
Figure 3-27: SI Tables view - Tear off view	3-66
Figure 3-28: Stream view - Template.....	3-69
Figure 3-29: Stream view - Log	3-72
Figure 3-30: Stream view - Configuration (MTM400 DVB format)	3-76
Figure 3-31: Stream view - Configuration (MTM400 ISDB format).....	3-77
Figure 3-32: Stream view - Configuration (MTM400 ATSC format)	3-77
Figure 3-33: Service logging - Data storage.....	3-81
Figure 3-34: Stream view - Summary	3-82
Figure 3-35: Configuration file handling	3-85
Figure 3-36: Scheduling and time zones	3-97
Figure 3-37: Triggered Recording dialog box.....	3-99
Figure 3-38: Interface configuration - QPSK (L-Band)	3-109
Figure 3-39: Input card screen - QPSK (L-Band)).....	3-112
Figure 3-40: Interface configuration - QAM (Annex A and Annex C).....	3-114
Figure 3-41: Input card screen - QAM (Annex A and Annex C).....	3-116
Figure 3-42: Interface configuration – QAM Annex B II	3-118
Figure 3-43: Input card screen - QAM Annex B II (example).....	3-120
Figure 3-44: COFDM interface configuration (example)	3-122
Figure 3-45: Input card screen - COFDM (Example)	3-124
Figure 3-46: 8VSB interface configuration (example).....	3-126
Figure 3-47: Input card screen - 8VSB (Example).....	3-128
Figure 3-48: 8PSK interface configuration (example)	3-129
Figure 3-49: Input card screen (example - 8PSK).....	3-131
Figure A-1: Network set-up - Example	A-1
Figure A-2: Transport stream processor reset switches.....	A-6
Figure B-1: Chassis section rack slides.....	B-2
Figure B-2: Rack mounted sections	B-3
Figure B-3: Installing or removing the rack slides.....	B-4

List of Tables

Table 1-1: Standard MTM400 deliverables	1-2
Table 1-2: MTM400 options (continued)	1-2
Table 1-3: MTM400 power cord options.....	1-3
Table 1-4: MTM400 field upgrade kits.....	1-4
Table 1-5: MTM400 options summary (part 1 of 2).....	1-6
Table 1-6: Electrical operating requirements	1-9
Table 1-7: Transport stream Processor card connectors	1-10
Table 2-1: Button colors - Hot Spot views.....	2-11
Table 2-2: Button colors - Device and Stream views.....	2-11
Table 3-1: Button colors - Information view	3-29
Table 3-2: DVB Regional Options.....	3-78
Table 3-3: ISDB Regional Options	3-78
Table 3-4: Chinese Regional Options	3-78

General Safety Summary

Review the following safety precautions to avoid injury and prevent damage to this product or any products connected to it. To avoid potential hazards, use this product only as specified.

Only qualified personnel should perform service procedures.

To Avoid Fire or Personal Injury

Use Proper Power Cord. Use only the power cord specified for this product and certified for the country of use.

Ground the Product. This product is grounded through the grounding conductor of the mainframe power cord. To avoid electric shock, the grounding conductor must be connected to earth ground. Before making connections to the input or output terminals of the product, ensure that the product is properly grounded.

Ground Equipment Connected to the Product. Ensure that any equipment connected to this product is grounded and at the same potential.

Observe All Terminal Ratings. To avoid fire or shock hazard, observe all ratings and markings on the product. Consult the manual for further ratings information before making connections to the product.

Do Not Operate Without Covers. Do not operate this product with covers or panels removed.

Use Proper Fuse. Use only the fuse type and rating specified for this product.

Avoid Exposed Circuitry. Do not touch exposed connections and components when power is present.

Do Not Operate With Suspected Failures. If you suspect there is damage to this product, have it inspected by qualified service personnel.

Do Not Operate in Wet/Damp Conditions.

Do Not Operate in an Explosive Atmosphere.

Keep Product Surfaces Clean and Dry.

Provide Proper Ventilation. Refer to the installation instructions for details on installing the product so it has proper ventilation.

Symbols and Terms

Terms in this Manual. These terms may appear in this manual:



WARNING. *Warning statements identify conditions or practices that could result in injury or loss of life.*



CAUTION. *Caution statements identify conditions or practices that could result in damage to this product or other property.*

Terms on the Product. These terms may appear on the product:

DANGER indicates an injury hazard immediately accessible as you read the marking.

WARNING indicates an injury hazard not immediately accessible as you read the marking.

CAUTION indicates a hazard to property including the product.

Symbols on the Product. The following symbols may appear on the product:



CAUTION
Refer to Manual



Protective Ground
(Earth) Terminal

Service Safety Summary

Only qualified personnel should perform service procedures. Read this *Service Safety Summary* and the *General Safety Summary* before performing any service procedures.

Do Not Service Alone. Do not perform internal service or adjustments of this product unless another person capable of rendering first aid and resuscitation is present.

Disconnect Power. To avoid electric shock, switch off the instrument power, then disconnect the power cord from the mains power.

Use Care When Servicing With Power On. Dangerous voltages or currents may exist in this product. Disconnect power, remove battery (if applicable), and disconnect test leads before removing protective panels, soldering, or replacing components.

To avoid electric shock, do not touch exposed connections.

Preface

This manual describes the functions and use of the Tektronix MTM400 MPEG Transport Stream Monitor. The manual is organized into the following sections:

- *Getting Started*
An overview of the MTM400, installation instructions, starting the unit, and the remote user interface.
- *Operating Basics*
A basic guide to the MTM400 user interface(s).
- *Reference*
A complete reference to all of the MTM400 features as accessed through the user interface.
- *Appendix A: Networking*
Details on configuring the instrument for network operation.
- *Appendix B: Maintenance*
General care and service procedures.
- Glossary
- Index

- *MTM400 MPEG Transport Stream Monitor Technical Reference*
(071-1560-xx)
This manual provides product specifications, test parameters, configuration file syntax, and hardware maintenance procedures.
- *MTM400 MPEG Transport Stream Monitor Programmer Manual*
(071-1375-xx)
This manual specifies the remote control and status monitoring interfaces available to a management application.

Related Material

Additional documentation, such as Read Me files, may be included on the installation disks.

The following URLs access the Web sites for the standards organizations listed (the URLs listed were valid at the time of writing):

- MPEG-2 standards (International Organization for Standards)
<http://www.iso.ch/>
- DVB standards (European Technical Standards Institute)
<http://www.etsi.org/>
- ATSC standards (Advanced Television Systems Committee)
<http://www.atsc.org/>
- ISDB/ARIB standards (Association of Radio Industries and Businesses)
<http://www.arib.or.jp/english/>
- SCTE Society of Cable Television Engineers
<http://www.scte.org/>

Manual Conventions

Naming conventions for the interface elements are based on standard Windows naming conventions. Naming conventions for MPEG-2, ATSC, and DVB structures follow the conventions derived from the standards organizations listed on the previous page. In addition, the following formatting conventions apply to this manual:

- Mono-spaced text can indicate the following:
 - Text you enter from a keyboard
Example: Enter the network identity (`http://TSMonitor01`)
 - Characters you press on your keyboard
Example: Press CTRL+C to copy the selected text.
 - Paths to components on your hard drive
Example: The program files are installed at the following location:
`C:\Program Files\Tektronix\`



Getting Started

Getting Started

This section provides details of installing and powering up the Tektronix MTM400 MPEG Transport Stream Monitor.

Overview

The MTM400 is a single-stream, extended-confidence, MPEG-2 protocol, monitoring device. It is used to monitor a single transport stream in MPEG-2, DVB, ISDB and ATSC environments. The MTM400 is a rack-mounted device.

The basic MTM400 provides confidence monitoring by making key measurements and comparing them with preset parameters; inconsistencies can be reported as varying levels of error. Integrated flexibility allows the software to be upgraded with diagnostic capabilities and to supply detailed information to enable fault identification and analysis.

The user interface is accessed through a Remote User Interface (RUI). The RUI allows the status of the MTM400 to be determined from anywhere in the world and provides remote control of the measurements and configuration to the administrator. The RUI is accessed through Microsoft Internet Explorer (Version 6 SP 1); the Microsoft Java Virtual Machine (Version 5.00.3809) must also be installed.

The user interface can also be accessed by the Multi-Layer Monitor (MLM1000) and the Web Monitoring Systems Manager (WebMSM),

The WebMSM is a Java application that is installed on any personal computer; as for the RUI, Microsoft Java Virtual Machine (Version 5.00.3809) must be available. The installation, configuration, and operation of the WebMSM is described in the WebMSM User Manual (071-1239-xx).

The RUI and the WebMSM communicate with the MTM400 through the open standard Simple Network Management Protocol (SNMP) and Hypertext Transfer Protocol (HTTP).

ASI (Asynchronous Serial Interface) and SMPTE 310M (Society of Motion Picture and Television Engineers, 19.392 Mbps only) interfaces are provided as standard; optional QAM (Quadrature Amplitude Modulation), COFDM (Coded Orthogonal Frequency Division Modulation), QPSK (Quadrature Phase Shift Keying) (L-Band), and 8VSB (Vestigial Sideband) interfaces are available as options.

Accessories

The tables in this section list the standard and optional accessories available for the MTM400 MPEG Transport Stream Monitor.

Standard

Table 1-1 lists the standard accessories that are shipped with the MTM400.

Table 1-1: Standard MTM400 deliverables

Nomenclature	Description	Deliverables
MTM400	Single stream MPEG Transport Stream Monitor; packaged in one rack unit (1RU) chassis	1RU Chassis fitted with Transport Stream Processor Card User Manual (English, L0 / Japanese, L5) Slides License Key Certificate

Options

Tables 1-2 and 1-3 list the options that are available for the MTM400.

Table 1-2: MTM400 options

Nomenclature	Description	Deliverables
Opt. 01	Recording Capability	Enabled using license key
Opt. 02	Transport Stream Service Information Analysis (PSI/SI/PSIP/ISDB structure view and repetition graphs)	Enabled using license key
Opt. 03	Template Testing with Template Scheduling (for user-defined service plan testing)	Enabled using license key
Opt. 04	PCR Analysis with Graphical Results views	Enabled using license key
Opt. 05	Bit rate testing including PID groups and PID variability	Enabled using license key
Opt. 06	Service logging	Enabled using license key
Opt. QA	QAM Annex A Interface	QAM (Annex A) Interface Card with associated cabling
Opt. QB2	QAM Annex B Interface (Level 1 and Level 2 Interleave)	QAM (Annex B II) Interface Card with associated cabling
Opt. QC	QAM Annex C Interface	QAM (Annex C) Interface Card with associated cabling

Table 1-2: MTM400 options (continued)

Nomenclature	Description	Deliverables
Opt. QP	QPSK (L-Band) Interface	QPSK Interface Card with associated cabling
Opt. CF	COFDM Interface	COFDM Interface Card with associated cabling
Opt. VS	8VSB Interface	8VSB Interface Card with associated cabling
Opt. EP	8PSK Interface	8PSK Interface Card with associated cabling

Table 1-3: MTM400 power cord options

Nomenclature	Description
A0	North America Power
A1	Universal Euro Power
A2	United Kingdom Power
A3	Australia Power
A4	240 V North America Power
A5	Switzerland Power
A6	Japan Power
A10	China Power
A99	No Power Cord

Field Upgrade Kits

Field upgrade kits contain hardware and software that can be installed by a user. Table 1-4 lists the Field Upgrade kits that are available for the MTM400.

Table 1-4: MTM400 field upgrade kits

Product	Option	Description
MTM4UP		
	01	Field upgrade kit to add Recording Capability
	02	Field upgrade kit to add Transport Stream Service Information Analysis (PSI/SI/PSIP/ISDB structure view and repetition graphs)
	03	Field upgrade kit to add Template Testing With Template Scheduling (for user-defined service plan testing)
	04	Field upgrade kit to add PCR Analysis with Graphical Results views
	05	Field upgrade kit to add Bit rate testing including PID groups and PID variability
	06	Field upgrade kit to add Service Logging
MTM4FQA	-	Field upgrade kit to add QAM Annex A Interface
MTM4FQB2		Field upgrade kit to add QAM Annex B (Level 1 and Level 2 interleave) Interface
MTM4FQC	-	Field upgrade kit to add QAM Annex C Interface
MTM4FQP	-	Field upgrade kit to add QPSK (L-Band) Interface
MTM4FVS		Field Upgrade Kit To Add 8-VSB Interface
MTM4FCF		Field Upgrade Kit To Add COFDM Interface
MTM4FEP		Field Upgrade Kit To Add 8PSK Interface

Licensing

Options and upgrades are enabled using a License Key. A License Key is an encrypted code that unlocks and enables functions that have been installed on the Real-Time Monitoring (RTM) device. Using this method, upgrading an RTM device may simply require the entry of a new License Key.

For new RTM devices, the appropriate License Key is applied during production. However, it is also supplied as part of the product documentation.

When field upgrade options are installed, you must apply a new license key; this will be supplied as part of the field upgrade kit documentation.

This user manual describes all available options including field upgrades. The basic product (with no licensed options) includes the following transport stream features:

- Test monitoring (DVB, ATSC, and ISDB)
- Custom classification of tests
- Basic program and PID analysis and monitoring
- Basic PCR analysis
- SFN and TMCC monitoring (where present in the stream)
- Stream Log

Table 1-5 (parts 1 and 2) summarizes the available streams options:

Table 1-5: MTM400 options summary (part 1 of 2)

Feature	Default *	Opt. 01 Recording Capability	Opt. 02 SI Analysis	Opt. 03 Template Testing
SFN	✓			
TMCC	✓			
PCR OJ, DR and FO testing	✓			
SI View			✓	
SI Graphs			✓	
PID and program bit rate limit testing				
PID Groups				
PID variability				
Templates				✓
Template tree view				✓
Scheduling				✓
Recording		✓		
PCR graphs				
Service log				
RF Confidence Measurement	✓			
Logging DPI section arrival				
Basic syntax checking of DPI sections				
Alarms Events on RF metrics				
DPI (SCTE35 Digital Program Insertion) Monitoring	✓			
RF Measurement Testing	✓			
Warning Events on RF metrics	✓			

* Confidence or no option license key required.

Table 1-5: MTM400 options summary (part 2 of 2)

Feature	Opt. 04 PCR Analysis	Opt. 05 Bit rate Testing	Opt. 06 Service Logging
SFN			
TMCC			
PCR OJ, DR and FO testing			
SI View			
SI Graphs			
PID and program bit rate limit testing		✓	
PID Groups		✓	
PID variability		✓	
Templates			
Template tree view			
Scheduling			
Recording			
PCR graphs	✓		
Service log			✓
RF Confidence Measurement			
Logging DPI section arrival			
Basic syntax checking of DPI sections			
Alarms Events on RF metrics			
DPI (SCTE35 Digital Program Insertion) Monitoring			
RF Measurement Testing			
Warning Events on RF metrics			

The Device application does not change with licensing.

An overview of the Streams and Device applications is given in the *Operating Basics* section.

Installing the MTM400

This section describes how to install the MTM400 unit. It includes the following instructions:

- Installing the unit in a rack
- Making the electrical connections necessary to begin monitoring transport streams
- Integrating the unit into a network

Operation is described in the following sections.

Hardware Installation

The MTM400 is designed for rack-mounted operation. The rack-mounting kit is shipped as a standard accessory with each MTM400. Installing the rack-mounting kit is described in the *MTM400 MPEG Transport Stream Monitor Technical Reference*.



WARNING. *To avoid fire hazard, the MTM400 must be installed in the rack only as specified and proper ventilation must be maintained at all times.*

Electrical Installation

The electrical operating requirements of the MTM400 are summarized in Table 1-6; see the *MTM400 MPEG Transport Stream Monitor Technical Reference* for more detailed electrical characteristics.

Table 1-6: Electrical operating requirements

Requirement	Specification
Temperature, operating	+5 °C to +40 °C
Altitude, operating	0 m to 3000 m (9800 ft)
Source Voltage	100 VAC to 240 VAC, 50 Hz/60 Hz
Power Consumption (maximum)	1 Amp
Peak Inrush Current	7.2 A peak at 240 VAC, 50 Hz
Fuse Rating	Mains fuse is 3.15 A, 250 V, Fast; Not operator replaceable. Refer servicing to qualified service personnel.
Overvoltage Category	II (as defined in IEC61010-1)
Pollution Degree	2 (as defined in IEC61010-1). Rated for indoor use only.

Use the following procedure to make electrical, signal, and network connections:

1. After the MTM400 has been mounted in the rack, connect the power cord (provided with the unit) to the power connector on the rear panel. Connect the power cord plug to a properly grounded outlet.

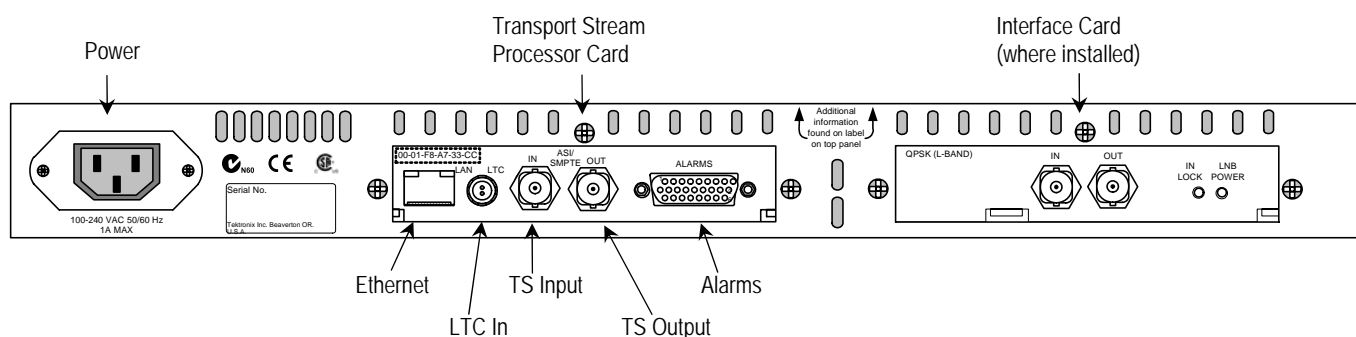

Figure 1-1: MTM400 connectors (shown with QPSK interface)

2. Make the necessary transport stream, network and peripheral device connections using the connectors at the rear of the unit.

Table 1-7 summarizes the transport stream, network and peripheral device connectors; (see the *MTM400 MPEG Transport Stream Monitor Technical Reference* for more detailed information about each connector and the associated signals).

Table 1-7: Transport stream Processor card connectors

Connector	Description
Ethernet	10/100Base-T; RJ-45
LTC In	Longitudinal time code input
Transport Stream input / output	75 ohm, transformer coupled, BNC connectors for the following signal formats:
ASI input (BNC)	• Accepts Burst and Packet mode ASI formats and M2S
ASI output (BNC)	• An active loop-through of the corresponding input
SMPTE310M input	• Compliant with SMPTE310M (19.392 Mbps only)
SMPTE310M output	• An active loop-through of the corresponding input
Alarms	(Digital input/output) 26-pin D-type connector for alarm relays and TTL outputs; also recording trigger input

The Alarms connector provides connections for five relays. Each relay is configured through the user interface (see *Tests Screen*, page 3-23 and *Custom Screen*, page 3-26); the three TTL outputs are configured in a similar manner.

ASI Loop-Through (QAM (Annex B), COFDM, 8VSB, and 8PSK only)

To monitor ASI and RF signals, (for example, both the input and output of a modulator):

- Connect the ASI signal from the modulator to the interface card **ASI In**.
- Connect the **ASI Out** terminal on the interface card to the **ASI In** connector on the Transport Stream Processor card.

Select the signal to be monitored from the configuration view (see page 3-76).

The ASI signal from QAM (Annex A and C) and QPSK (L-Band) interface cards is looped to the Transport Stream Processor card internally.

Network Installation

The MTM400 is designed to operate in a networked (TCP/IP) environment. The network or system administrator may have already configured the TCP/IP parameters (including the network identity) for the MTM400. If this is not the case, refer to *Appendix A: Network Installation* for procedures to configure the TCP/IP parameters.

Setting the Font Used By the RUI

If the RUI does not show the program names and logs in the correct character set, first ensure that the correct standard is selected for the broadcast being monitored. If the characters are still incorrect, you must configure the RUI to use a font that supports the characters in use.

1. Locate the file **MTM400.INI**. This is typically in the Java folder inside the Windows folder or in your home directory.

This file is formatted in Unix text. If a Unix file-format compatible text editor (for example, PFE) is not available, edit file in Notepad. Be careful not to add any new lines; only edit what is there.

2. Within the MTM400.INI file, change **UnicodeOn=false** to **UnicodeOn=true**, save the file, and restart the RUI.
3. The RUI will attempt to select a suitable font installed on the system. If the displayed characters are still incorrect, close the RUI and reopen MTM400.INI.
4. Change the **UnicodeFont=Arial Unicode MS** section to the name of the TrueType font you want to use, for example **UnicodeFont=MS Gothic**. Save the file and restart the RUI.

The default Arial Unicode MS is shipped with many Microsoft products and operating systems; it includes the whole Unicode character set. This font provides the best compromise to display the non-English program names and the English elements of the user interface. If this font is unavailable, similar fonts are commercially available, for example from Bitstream Inc. (www.bitstream.com).

The preceding instructions relate to running the RUI under the Microsoft Java Virtual Machine. Some users choose to run the WebMSM under the Sun Java Virtual Machine, however, this is an unsupported configuration. In this case, the user should see the Sun documentation relating to modifying 'font properties'. The exception is when the RUI is integrated into the MLM1000. In this case, refer to the user manual (Tektronix part number 071-1433-xx) that accompanies the MLM1000.

Installing Font Extensions on Your PC

The ARIB specifications for ISDB make use of private extensions to the standard Unicode character set [0xE000-0xF8FF]. These extensions provide additional characters and non-standard proprietary characters; they are used to extend an existing font. Check with the transport stream broadcaster for the availability of any font extension set for their transport stream. Because these font extension files are specific to the broadcaster, they are not supplied by Tektronix.

The extension sets are provided as TrueType Extension files (*.tte). Any extension sets should be installed using the Private Character Editor which is supplied as part of the standard Windows installation.

The following paragraphs describe the general procedure required to install an extension set:

1. Select **Start => Run**.
2. Enter **eudcedit** and select **OK**.
3. The Private Character Editor is opened. Close the **Select Code** dialog box.
4. Select **File => Font Links....**
5. In the Font Links dialog box, select the **Link with selected fonts** option. (If **Link with all fonts** is selected, the following actions will overwrite any existing extension sets.)
6. In the **Select Fonts** box, find and highlight the font to which the extension is to be made; this font should be the one used in the RUI.
7. Select **Save As.....**
8. Browse to the supplied TrueType extension file (*.tte) and select **Save**.
9. In the **Font Links** dialog box, select **OK**.
10. Close the Private Character Editor.

To check that the extension has been successfully installed:

1. Open the Character Map application (Select **Start => Run** and enter **charmap**).
2. Select **font name (Private Characters)** and note the extended character set.
3. Close the Character Map application.

The extended character set is now available for use when the font is selected.

Powering Up the MTM400

After the connections have been made to the unit, all that is required to power up the MTM400 is to apply power. Connect the power cord to a properly grounded outlet. Connect the other end of the cord to the product's power input (see *Figure 1-1*).

There is no mains disconnect switch. Initialization will begin as soon as power is connected to the power input. The LEDs on the front panel will indicate activity (see *Local Indicators*, page 2-2). Initialization can take up to 60 seconds.

Disconnect the power cord to remove power.

The Remote User Interface

The Remote User Interface (RUI) provides a means of accessing the MTM400 configuration and monitoring features. The RUI can be run on any personal computer (client PC) that meets the minimum specification and has network access to the MTM400 unit. The full specification is given in the *MTM400 MPEG Transport Stream Monitor Technical Reference*.

Logging on

To access the configuration and monitoring features of the MTM400, use the following procedure:

1. At a networked PC, launch Microsoft Internet Explorer.
2. In the browser address bar, enter the network identity or IP address of the MTM400 unit, for example:

`http://TSMonitor01` or `http://192.201.121.231`.

When the Enter key is pressed, a Java applet is downloaded from the MTM400 unit and launched. The file size is approximately 1.5 MB; the download time will depend on the network speed and traffic.



CAUTION. *The Java applet will not run unless a 'temp' directory is properly configured on the PC.*

The Java applet will not run unless the Microsoft Java Virtual Machine is installed. Type 'jview' at the command prompt to verify that it is installed and that the version is 5.00.3809 or greater. If it is not installed, obtain the installation file from the Tektronix Web site.

If the Sun Virtual Machine also has been installed, the Sun Virtual Machine must not be set as the default in the Java control panel or Internet Explorer options, advanced tab.

The MTM400 splash screen is displayed overlaid shortly thereafter by the **Login Details** dialog:

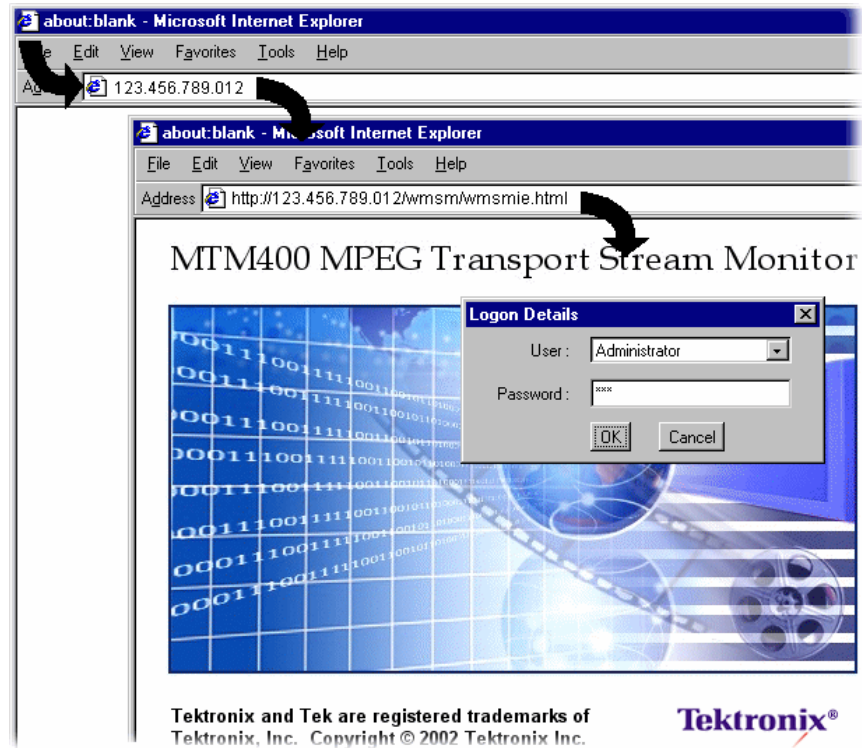

Figure 1-2: Logging on

3. Select the User name (Administrator or User from the drop-down list).

Two User Names are available at installation: Administrator and User.

Administrator: Gives full read/write access to all views and settings, including options where installed.

User: Gives read only access to all views and settings, including options where installed. You can also reset alarms.

4. Enter the password. The default password for the Administrator is tek; no password is allocated to the User. The password can be modified using the Device Configuration screen (see page 3-13).

Select **OK** to accept the details. Select **Cancel** to close the dialog.

(To redisplay the **Logon Details** dialog, either reenter the network identity of the MTM400 or select the **Refresh** button in the browser.)

5. The Hotspot and Stream views are displayed.

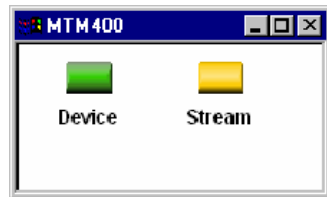

Figure 1-3: Hotspot view

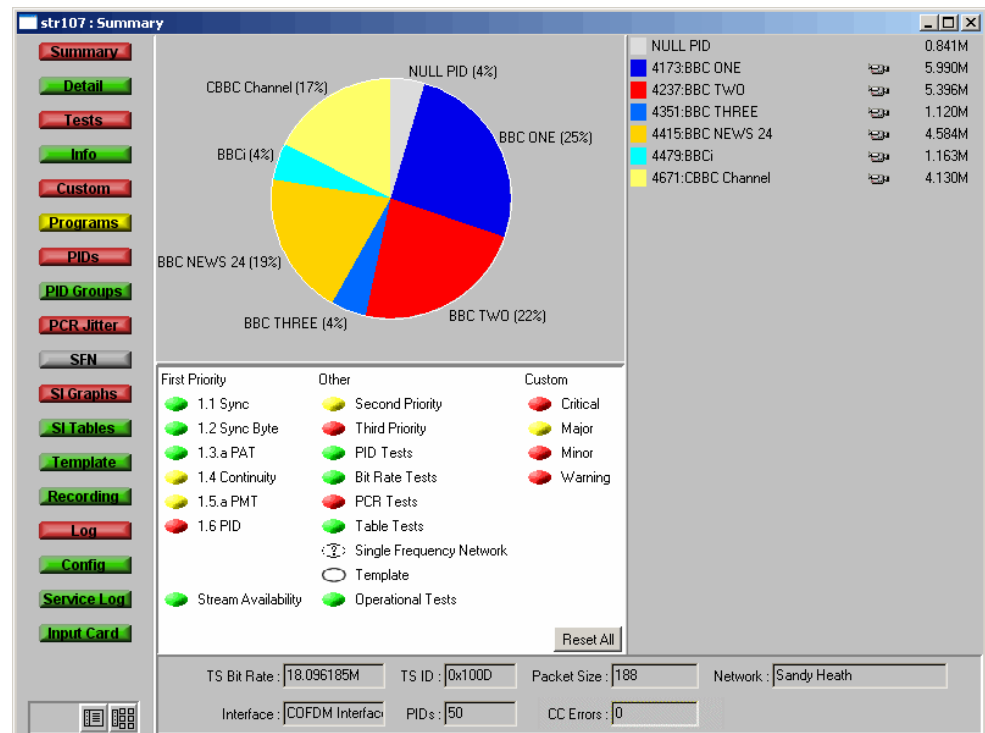

Figure 1-4: Summary view

The Hotspot view provides access to the device and stream monitoring views of the MTM400 being accessed.

High Level Monitoring

The Hot Spot view allows the overall state of the MTM400 device and the stream to be viewed; each hotspot is appropriately labeled.

The color of the Hot Spot button indicates the error status of the item to which it is linked (see *Color Coding*, page 2-11).

In the Hot Spot view, the error state of the linked item is as follows:

- Device - the highest error state of the MTM400 device.
- Stream - the highest error state of the stream.

When you left-click a hot spot, the appropriate view opens: Device or Stream.

A detailed description of the user interface is provided in the Reference section of this manual.

Closing the Remote User Interface

Closing the original Internet Explorer window closes the RUI; the application windows close simultaneously.



Operating Basics

Operating Basics

This section provides an overview of the basic operation of the system; details and background material are found in the Reference section.

The monitoring activity of the MTM400 can be observed in three ways:

- Local indicators
- Remote User Interface (RUI)
- WebMSM

Options are available to the RUI and the WebMSM to upgrade the monitoring from simple conformance checking to full diagnostic capability using license keys. The following sections describe all available options; your MTM400 may not have all options enabled.

Local Indicators

The MTM400 is an MPEG monitor for use in remote situations and does not have a local graphical user interface display. However, a local interface, consisting of four front-panel LEDs, can assure you that the MTM400 unit is functioning.

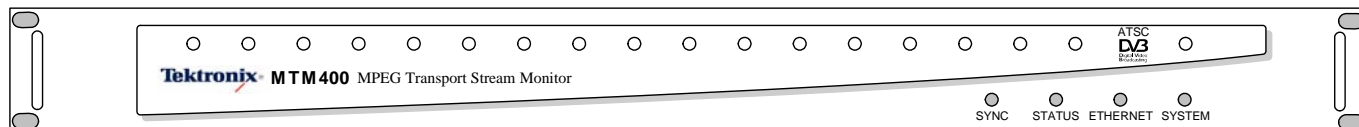

Figure 2-1: Front panel

These LEDs indicate the following:

- | | |
|-----------------|---|
| SYNC | Indicates that a valid MPEG transport stream is connected to the unit. |
| STATUS | Indicates the combined state of the tests currently being performed on the stream. The test reported by the STATUS LED corresponds to the Any Stream Error in the RUI (see <i>Device Status</i> , page 3-2). |
| ETHERNET | Indicates the state of the Ethernet physical link. |
| SYSTEM | State of all non-stream items (hardware, time sources). The test reported by the SYSTEM LED corresponds to the Any Box Error in the RUI (see <i>Device Status</i> , page 3-2). |

Each LED can show one of three colors:

- Green indicates that the monitor is currently passing the test.
- Red indicates that the monitor is currently failing the test.
- Yellow indicates that the monitor is currently passing the test, but has failed since the last system reset.

The Ethernet LED never shows yellow.

Remote User Interface

The Remote User Interface (RUI) allows you to configure and monitor the MTM400. The RUI can be run on any personal computer (client PC) that meets the minimum specifications (refer to *MTM400 MPEG Transport Stream Monitor Technical Reference*) and that has access to the MTM400 unit.

You can open the RUI of more than one RTM device by opening a new browser window each time; however, this may place an excessive processing load on your PC.

With the RUI accessed through your PC browser, three primary screens (or views) are provided to enable monitoring and configuration of the MTM400: Hot Spot View, Device View, and Stream View.

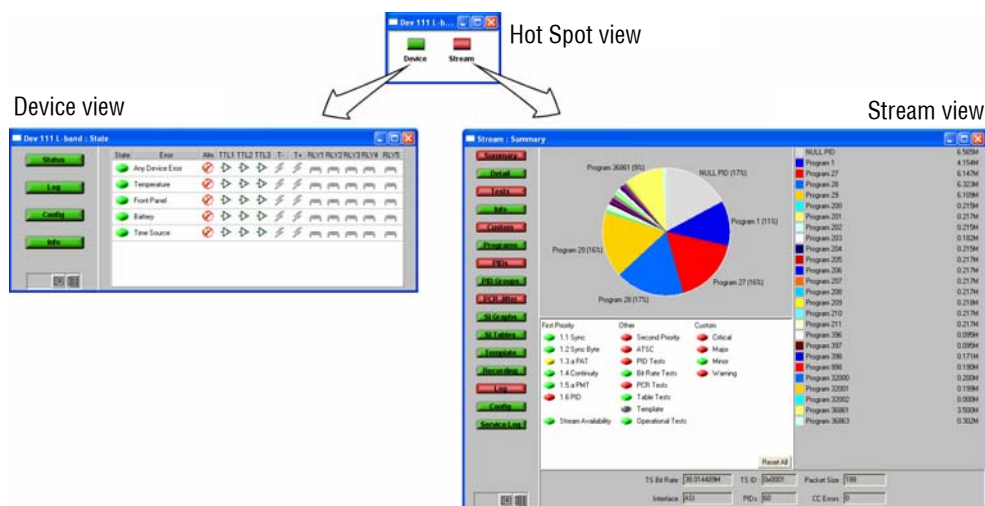

Figure 2-2: RUI overview

To close the Remote User Interface, close the original web browser window. All associated windows will close.

Hot Spot View

The Hot Spot view lets you see the overall state of the MTM400 and the stream; each hotspot is appropriately labeled.

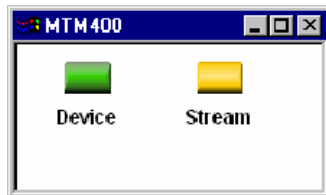

Figure 2-3: Hotspot view

The color of the Hot Spot button indicates the error status of the item to which it is linked (see *Color Coding*, page 2-11).

For example, in Figure 2-3, the **Device** button is green and the **Stream** button is yellow. This indicates that no errors have occurred on the device; an error has been noted on the stream, but it is currently OK.

The color (or state) of the Device and Stream hot spots corresponds to the Any Box Error and Any Stream Error tests in Device and Stream views.

If you click on a hot spot, the appropriate MTM400 view will open.

Device View

The Device view allows you to monitor and set parameters specific to the MTM400 device itself. The view contains a menu bar with various buttons, and an information view. You can choose the information that appears in the view by pressing the appropriate button. The button color indicates the overall state of the information in the corresponding view (see *Color Coding*, page 2-11).

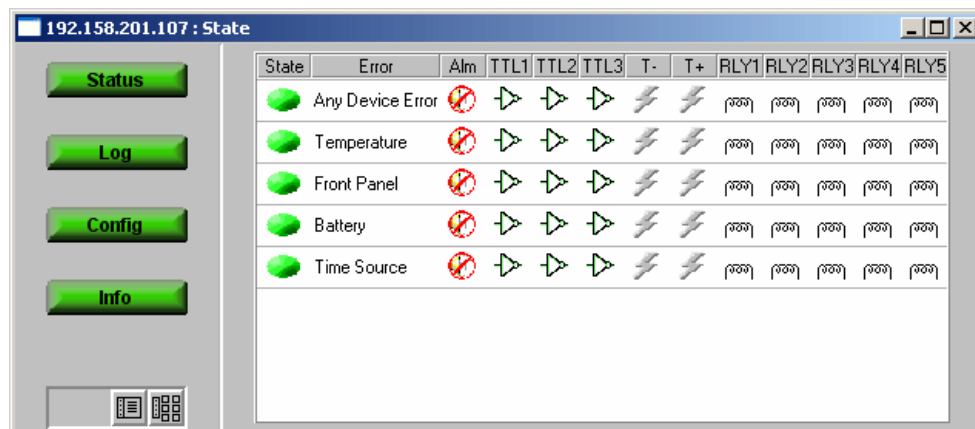

Figure 2-4: Device view

The title bar displays the name of the device to which you are connected (the name you set in the Device Configuration view) and the current view type. The screens provided are:

- Status** Displays the state of hardware items on the MTM400. It also allows administrators to configure alarms and relays and parameters associated with each item.
- Log** Displays the MTM400 device log, which includes non-stream events such as 'Device Start'.
- Config** Displays general configuration parameters for the MTM400. Administrators can modify certain parameters.
- Info** The Information view details the software and hardware build state of the MTM400.

Stream View

The Stream view allows you to monitor and set parameters specific to the stream being monitored.

As with the Device view, the screen consists of a menu bar with various buttons, and an information view. You can choose the information that appears in the view by pressing the appropriate button. The color of the button shows the overall state of the information that will be shown in the corresponding view (see *Color Coding*, page 2-11).

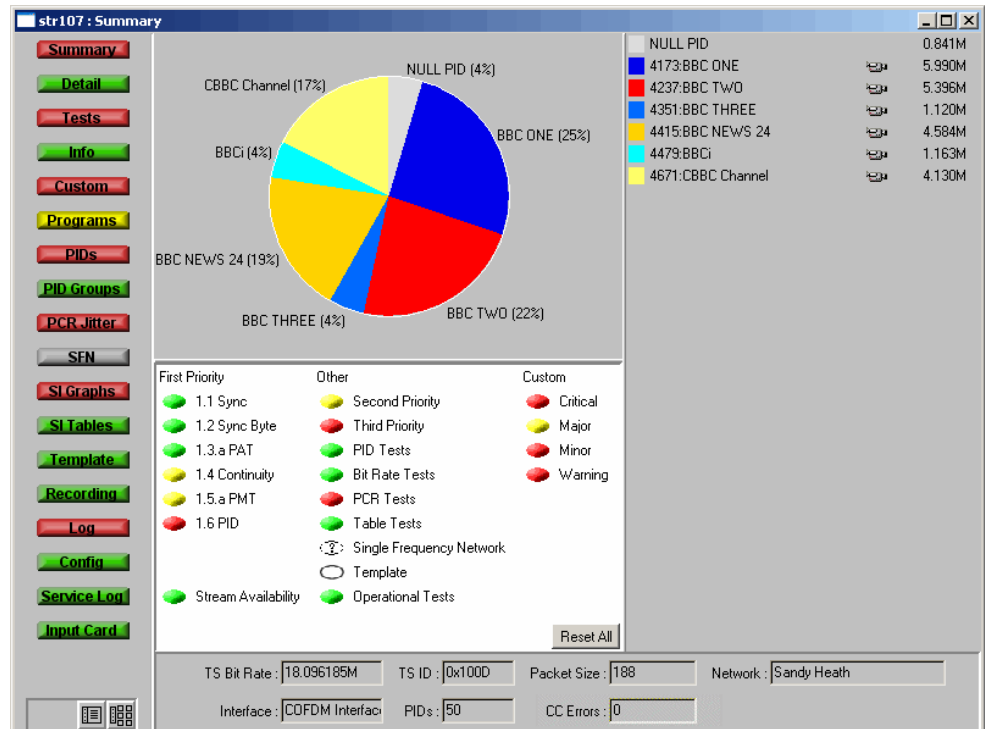

Figure 2-5: Stream view

The title bar displays the name of the device to which you are connected (the name you set in the Device Configuration view) and the current view type.

The information takes the form of a series of screens; a brief summary of each follows:

- | | |
|---------------------|--|
| Summary | A dynamic visual overview of the stream and monitoring status. The information is updated at regular intervals. (See page 3-20.) |
| Detail | Displays the detailed information about the stream according to SI tables, PIDs, or Program. (See page 3-22.) |
| Tests | Displays the state of the tests applied to the stream. It also allows users with read-write permissions (Administrators) to configure alarms and relays and parameters associated with each test. (See page 3-23.) |
| Information | Displays events not normally logged in the Stream log; for example, PAT/PMT version changes. (See page 3-28.) |
| Custom | Displays the state of the tests in the same way as the Tests view, but categorized as Critical, Major, Minor or Warning.

The allocation of tests to categories is preconfigured, but you can override the settings at run time. However, the settings will not be saved when the RUI is closed (using the WebMSM allows permanent configurations to be saved). (See page 3-26.) |
| Programs | Displays the programs that are being transmitted on the stream along with bit rate and the minimum and maximum bit rates that are observed. Administrators can set bit rate limits for each program if the bit rate limits option is licensed. (See page 3-30.) |
| PIDs | Displays the PIDs that are being transmitted on the stream along with bit rate and the minimum and maximum bit rates that are observed. Administrators can set bit rate limits for each PID if the bit rate limits option is licensed. (See page 3-34.) |
| PID Groups * | Displays the PID groups that you have created. The displayed information includes the error state and the bit rate. (See page 3-41.) |

PCR Jitter *	Displays the following PCR graphs: Inaccuracy, Arrival, Overall Jitter, Frequency Offset, and Drift Rate. (See page 3-48.)
SFN	Displays the Single Frequency Network (SFN) information when available. (See page 3-56.)
TMCC	Displays the Transmission and Multiplexing Configuration Control (TMCC) and IIP information when available. (Only available for ISDB streams) (See page 3-57.)
SI Graphs *	Displays information about repetition rates of SI tables and subtables in graphical format. (See page 3-58.)
SI Tables *	Displays the SI Information for the stream. (See page 3-62.)
Template *	Displays the structure and status of templates applied to the stream. (See page 3-68.)
Recording *	Displays the Triggered Recording setup screen. (See page 3-71.)
Log	Displays the stream log. (See page 3-72.)
Config	Displays general configuration parameters for the stream. Administrators can modify certain parameters. Scheduling, triggered recording, and interface setup are configured here. (See page 3-76.)
Service Log	Displays the Service Log. Service logging allows packet counts for specified PIDs (range: 0 to 100) to be collected at a user-definable interval. (See page 3-80.)
Input Card	Displays the relevant graphs and setup of any installed interface card. (Only displayed if an interface card is present.) (See page 3-107.)

* - licensed options (see Table 1-5: MTM400 Options Summary).

Device and Stream View Manipulation

The manipulation of the Device and Streams views is similar. Each view consists of a Button bar and an information window. The two view elements can be displayed either combined (a single window with the Button bar on the left) or as separate elements (the Button Bar and the information window are displayed separately). When displayed as separate windows, multiple information windows can be opened. The choice is made by selecting one of the two buttons at the bottom of the Button bar.

Combined View. Figure 2-6 illustrates the combined Device view; the Streams view is similar. Each time a button is selected, the adjoining view changes.

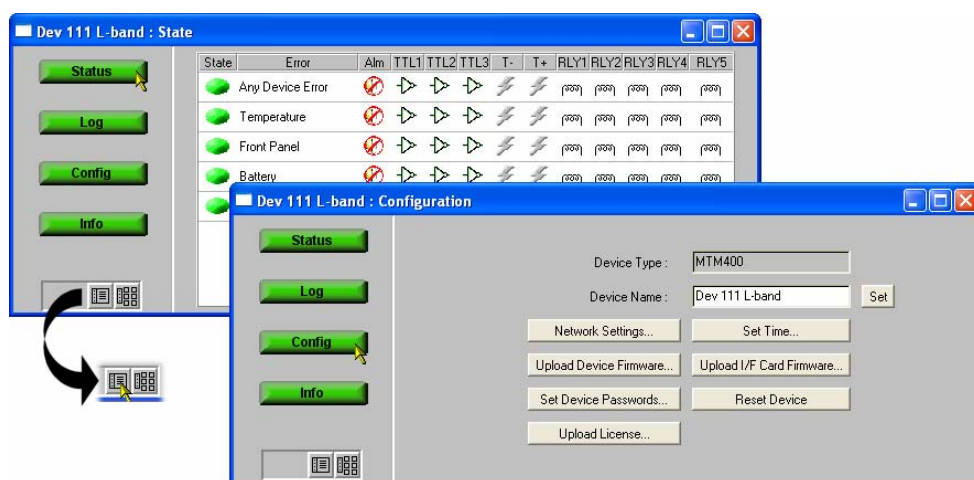

Figure 2-6: Combined view

Multiple View. Figure 2-7 illustrates the multiple Device view; the Streams view is similar. Each time you select a function button, a new window opens.

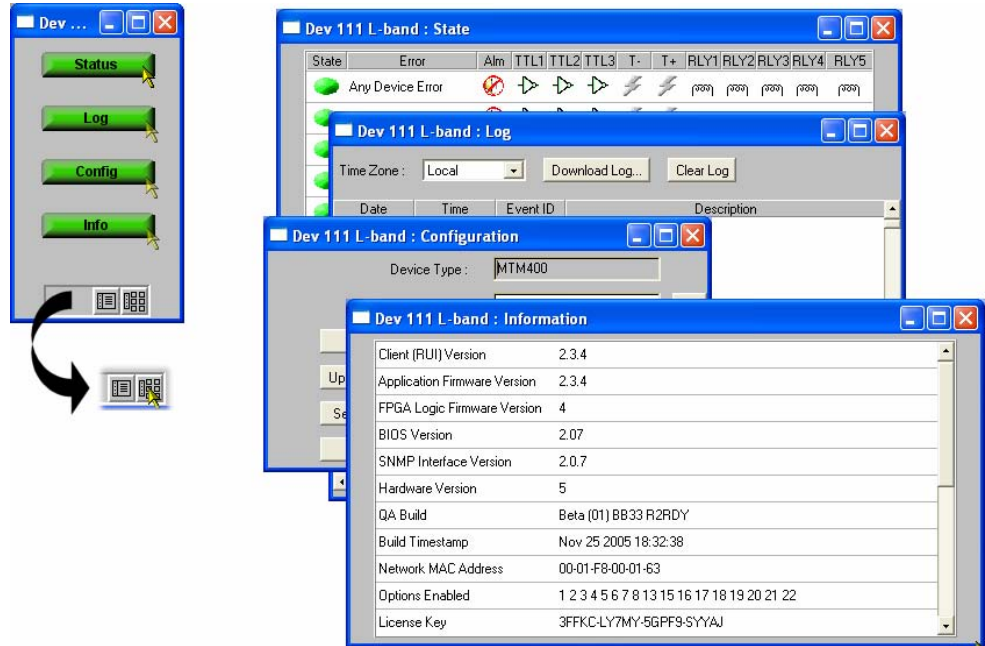
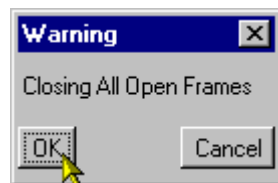

Figure 2-7: Multiple view

When switching from multiple view to combined view, you will be asked to acknowledge that all the function windows will close before the combined view window can be displayed.







The individual Device and Streams function windows are described in the *Reference* section of this manual.

Color Coding







In the RUI Hot Spot View, the Device and Stream buttons use the color scheme shown in Table 2-1.

Table 2-1: Button colors - Hot Spot views

Icon	Color	Meaning
 Device	Green	Operation normal — no error detected.
 Device	Red	Error detected and still present.
 Device	Yellow	Transient error, which has now corrected itself.
 Device	Gray	The corresponding test has been disabled (or is unavailable). All buttons gray indicates that connection to a device has been lost.

In the Stream and Device views, the buttons and icons use the color-coded error scheme shown in Table 2-2.

Table 2-2: Button colors - Device and Stream views

Icon	Color	Meaning
	Green	Operation normal — no error detected.
	Red	Error detected and still present.
	Yellow	Transient error, which has now corrected itself.
	Gray	The corresponding test has been disabled (or is unavailable). All buttons are gray indicates that connection to a device has been lost.
	White	Test not applicable.
	Clear / ?	Test unknown or incomplete (for example, during a measurement settling time).
	Black	Maintenance mode.

Where buttons represent a collection of elements (for example, for the Status button), the color indicates the highest error state of the elements.

Using WebMSM

If you have a system consisting of MTM400 units, you can expand your monitoring capabilities by using the WebMSM Monitoring System Manager.

The WebMSM software is effectively an installed version of the RUI. The WebMSM software provides additional functionality by allowing you to create hierarchical network views of your systems using the WebMSM Configuration Editor, and monitor and control multiple devices. The WebMSM user interface is similar to the RUI.

For further information concerning installing and configuring the WebMSM, refer to the WebMSM User Manual (Tektronix part number 071-1239-xx).

Using MLM1000

If you have a system with a number of Tektronix monitoring devices, which are not limited to MTM400 units, you can enhance your monitoring capabilities by using the MLM1000 Multi-Layer Monitoring software.

The MLM1000 software manages a hierarchical network of MTM400 units, waveform monitors, RF monitors and other instruments. Like the WebMSM software, it is installed on the PC; the MTM400 interface is identical to the RUI.

For further information concerning installing and configuring the MLM1000 software, refer to the MLM1000 Multi-Layer Monitoring Software User Manual (Tektronix part number 071-1433-xx).

User Interface Version

The software version of the user interface (RUI or WebMSM) is shown on the device information screen (page 3-1). Ensure that the RUI version is the same as the FW version installed in connected MTM400s.

Time Zones

An inevitable consequence of allowing the RTM device user interface to be accessed across networks is the crossing of time zones. Various features of the user interface display timing information, including the Log files. You need to know the time source being used to record events. Also, when scheduling the loading of configuration files, time zones must be taken into account (see *Scheduling*, page 3-91).

Figure 2-8 shows a typical setup in which an MTM400 is located in Denver and is monitored from Portland. In local time, Portland is one hour behind Denver. In this example Universal Coordinated Time (UTC) is 10 p.m. Therefore the local times in Portland and Denver are 2 p.m. and 3 p.m. respectively.

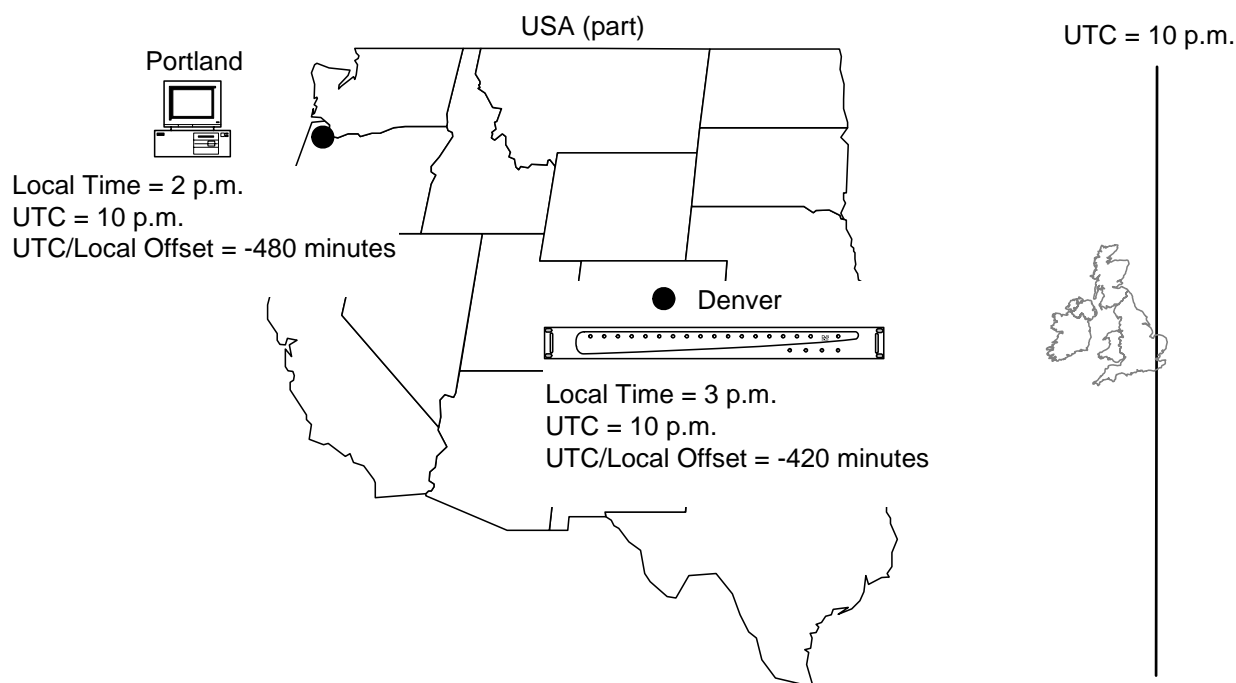

Figure 2-8: Time zones - illustration

The MTM400 user interface allows you to coordinate times of the system elements and to choose the local reference time zone; UTC, local time at the client PC or local time at the RTM device. All times are calculated with respect to Universal Coordinated Time. (See *Device Configuration - Set Time*, page 3-9.)



Reference

Device View

The Reference section provides a detailed description of each of the views available in the RUI. The descriptions are given in the order in which they appear in the two primary views: Device and Streams.

The Device view allows you to monitor and set parameters specific to the MTM400 unit. The view consists of a menu bar with various buttons, and an information view. You can choose the information that appears in the view by pressing the appropriate button. The color coding of buttons is explained in the previous section (see *Color Coding*, page 2-11.)

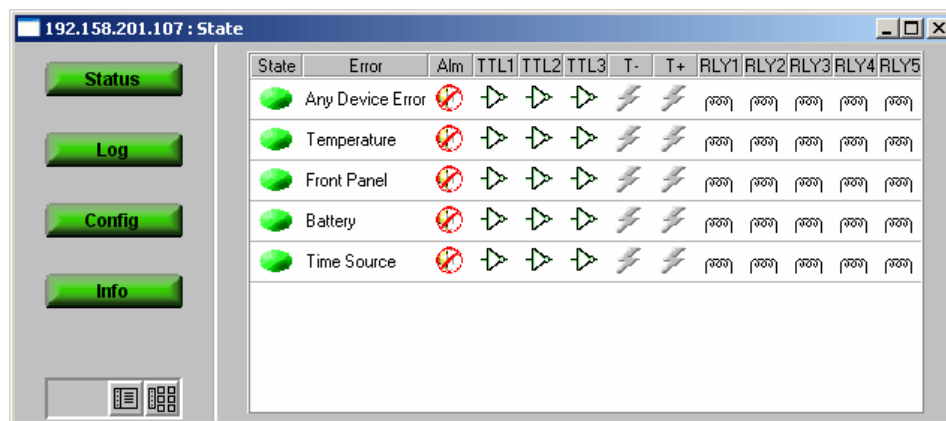

Figure 3-1: Device view

The title bar displays the Device Name and the current view type.

The screens provided are:

- Status** Displays the state of hardware items that are installed on the MTM400. It also allows administrators to configure alarms and relays and parameters associated with each item. (See page 3-2.)
- Log** Displays the MTM400 device log. (See page 3-4.)
- Config** Displays general configuration parameters for the MTM400. administrators can modify certain parameters. (See page 3-6.)
- Info** The Information view details the software and hardware build state of the MTM400. (See page 3-15.)

Device Status

The Device Status option displays a screen that shows the status of MTM400 device events (as opposed to stream events).

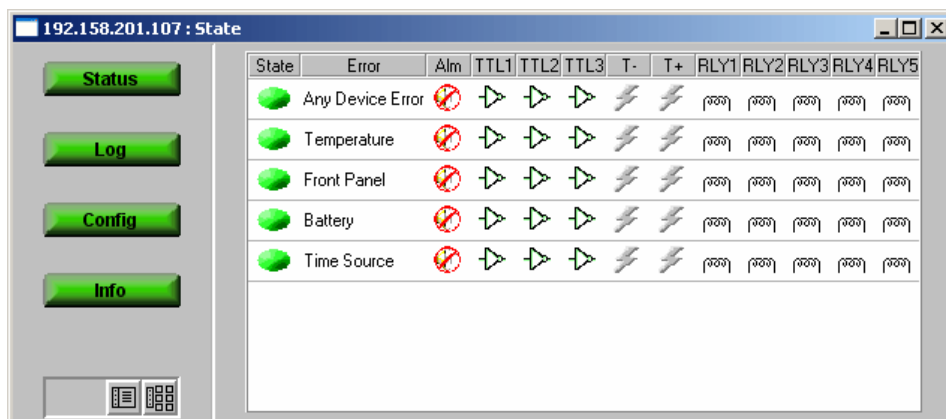

Figure 3-2: Device view - Status

The events displayed will depend on the RTM device type; those currently shown for the MTM400 are as follows:

Any Device Error Provides an overview of the device error state, which includes the events shown in this panel.

Temperature When active, indicates that the maximum temperature monitored at the front panel and the processor board has exceeded the safe operating limit.

Front Panel When active, indicates that either the temperature at the front panel has exceeded the safe operating limit, one or more of the LEDs has failed, or the audible alarm is faulty.

Battery When active, indicates that the configuration backup battery on the TS Processor board has failed. In this case, all configuration settings will be lost when power is removed from the unit.

Time Source When active, indicates that the time source selected in the **Set Time...** section of the Device Configuration (see page 3-9) has failed.

Typical display elements are described in the following paragraphs:

State A button showing the **State** of the event.
(See *Color Coding*, page 2-11.)



A right-click on the button will open a popup menu that allows you to reset the error or enable/disable the event monitoring. Double-clicking the button will toggle event monitoring between enabled and disabled.



Error Name of the **Error** event (for example, Fan).

Alm An icon indicating whether an audible alarm (**Alm**) will sound when an error of the type occurs. Double-clicking the icon will toggle its state: enabled or disabled.

 - Disabled;  - Enabled



(See the *MTM400 MPEG Test Technical Reference* for additional details.)

TTLn An icon indicating whether the TTL (**TTLn**) will activate when an error occurs. Double-clicking the icon will toggle its state: enabled or disabled.



 - Disabled;  - Enabled

(See the *MTM400 MPEG Test Technical Reference* for additional details.)

SNMP (**T-** and **T+**) Indicates whether SNMP trap messages should be sent when a specific event starts and finishes.

 - Off (gray);  - On (yellow)

RLYn An icon indicating whether the relay (**RLYn**) will activate when an error occurs. Double-clicking the icon will toggle its state: enabled or disabled.

 - Disabled;  - Enabled

(See the *MTM400 MPEG Test Technical Reference* for additional details.)

View Device Log

The Device Log records device-specific events associated with the selected MTM400. Logged events are displayed in a scrolling list. The Date, Time, Event ID and a description of each event is displayed.

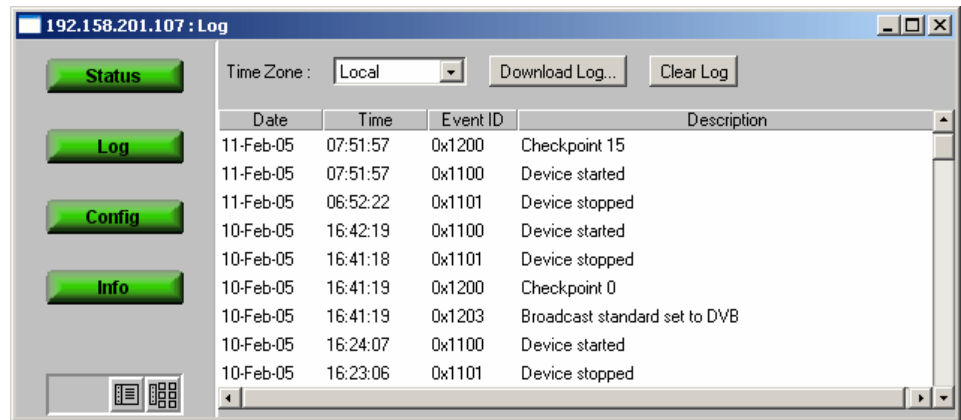
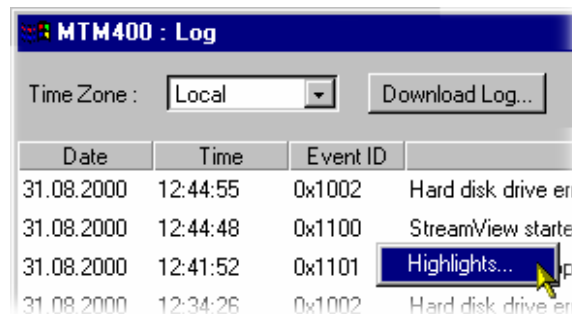
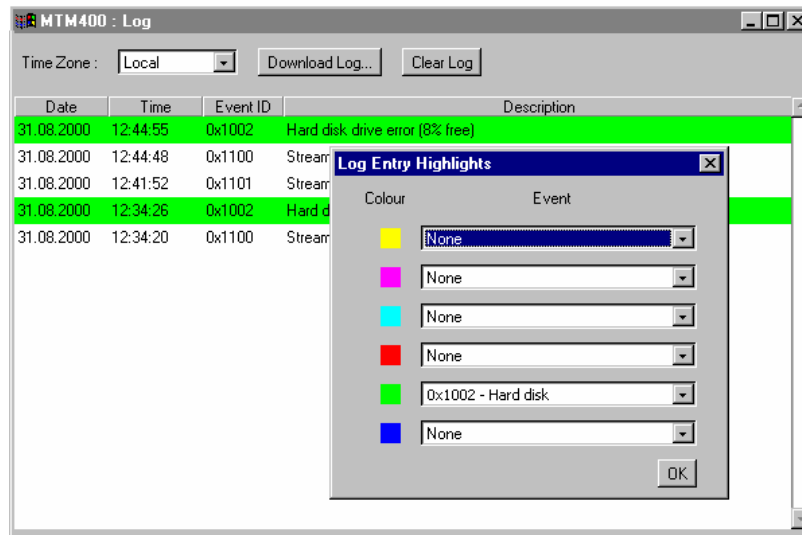

Figure 3-3: Device view - Log

Highlighting Log Entries

To open a pop-up menu from which log entry highlight coloring can be initiated, right-click anywhere within the listing.





Using the Log Entry Highlights dialog allows specific types of entries to be highlighted in a selected color. Select the **Event** type to be highlighted from the drop-down list adjacent to the **Color** required; hex values are shown in the event list. Select **OK** to close the dialog and implement the highlighting.

Saving the Device Log

The Device Log can be saved using the **Download Log...** button. In the **Log Download** dialog, select (or enter) a filename and path and select the **Start** button. Select the **Close** button when the operation has finished or to terminate the process early.

The resulting downloaded log file is saved in CSV (comma separated values) format.

Clearing the Device Log

Select **Clear Log** to clear the current log entries.

Time Zone

Monitoring devices across time zones may cause some confusion with respect to the timing of events. The displayed times at which log events occurred can be adjusted by making a selection from the **Time Zone** drop-down list at the top of the window. The following options are available:

- Local** The time local to the machine on which MTM400 Remote User Interface is currently running.
- UTC** Universal Coordinated Time.
- RTM Device** The time local to the RTM device being monitored.

Device Configuration

The Device Configuration screen allows you to configure items specific to the MTM400 unit being monitored.

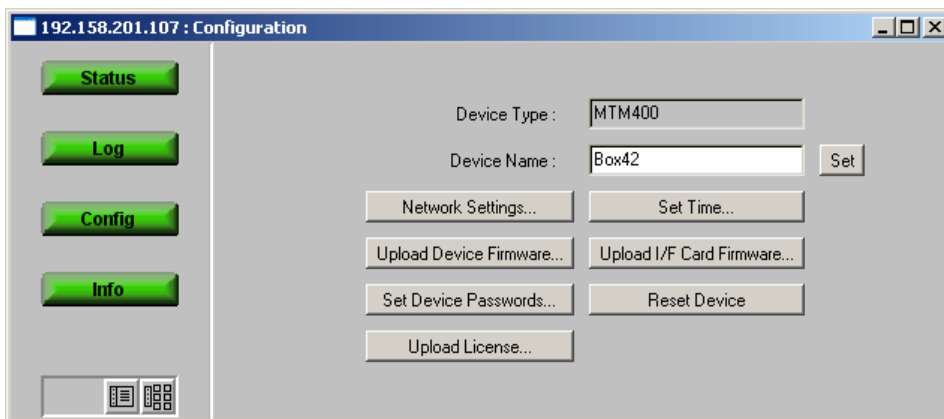

Figure 3-4: Device view - Configuration

Device Type: Displays the monitoring device type; this information is read from the unit being monitored.

Device Name: You can give the monitoring device a name, which is then displayed in the title bar of all screens. You need not enter a Device Name if the IP address of the device is displayed.

Enter the required name and select **Set** to activate it.

Network Settings...

Allows the network settings of the device to be reconfigured. (See *Network Settings*, page 3-7.)

Set Time... Allows the RTM device time to be set.
(See *Set Time*, page 3-9.)

Upload Device Firmware...
Allows new firmware to be uploaded to overwrite the existing device firmware.
(See *Firmware Upload*, page 3-11.)

Upload I/F Card Firmware...
Allows new firmware to be uploaded to overwrite the existing interface card firmware.
(See *Firmware Upload*, page 3-11.)

Set Device Passwords
Allows the RUI passwords to be set.
(See *Passwords*, page 3-13.)

Reset Device Resets the MTM400 by rebooting. The configuration is reloaded from non-volatile RAM; any configuration settings not saved before the reset will be lost.
(See *Device Reset*, page 3-13.)

Upload License...
Allows the License Key details to be entered.
(See *Upload License*, page 3-14.)

Network Settings

Although the MTM400 network identity is initially set up during installation, it can be changed subsequently through the **Network Settings** dialog.

SNMP community strings can also be set using the **Network Settings** dialog box.

In all cases, when the values have been changed as required, select the adjacent **Set** button to store the new settings in the MTM400.

To open the **Network Settings** dialog, select **Network Settings** from the Device Configuration dialog.

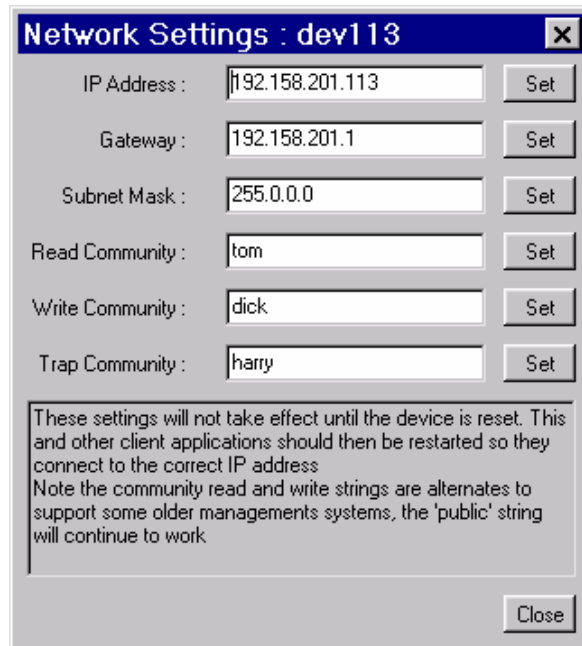

The image shows a dialog box titled "Network Settings : dev113". It contains several input fields, each with a "Set" button to its right:

- IP Address : 192.158.201.113
- Gateway : 192.158.201.1
- Subnet Mask : 255.0.0.0
- Read Community : tom
- Write Community : dick
- Trap Community : harry

Below these fields is a text box containing the following information:

These settings will not take effect until the device is reset. This and other client applications should then be restarted so they connect to the correct IP address
Note the community read and write strings are alternates to support some older managements systems, the 'public' string will continue to work

At the bottom right of the dialog is a "Close" button.

When the network settings have been changed and set and **Close** is selected, the following dialog is displayed:

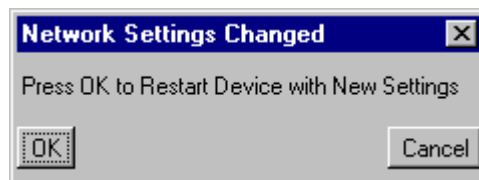

The image shows a dialog box titled "Network Settings Changed". It contains the text "Press OK to Restart Device with New Settings" and two buttons: "OK" and "Cancel".

For the network settings to take effect, select **OK** to restart the device. Select **Cancel** if a restart is not required. The new settings will not take effect until the unit is restarted.

If necessary, obtain the IP Address, Gateway and Subnet Mask values from the Network Administrator.

NOTE. *If the Network Settings are changed and the MTM400 is restarted, the PC that is running the RUI will be unable to communicate with the MTM400, since the browser is trying to communicate with the previous network identity. It will be necessary to close the RUI by closing the Internet Explorer. Internet Explorer can then be reopened and the MTM400 accessed using the new network identity.*

This is true of any WebMSM system configuration, which must be revised using the WebMSM Configuration Editor (refer to the WebMSM user manual).

Set Time

You can coordinate the time used by the RTM device and/or the remote user interface. (For a general description of the timing model, see *Time Zones*, page 2-13.)

Three time sources are available to the MTM400 from the **Time Source** drop-down menu.

Real Time Clock The MTM400 internal clock.

LTC (Longitudinal Time Clock) An analogue format time clock often available from a centralized source.

SNTP (Simple Network Time Protocol) A UTC-synchronized time clock available over the internet. Appropriate IP addresses of time servers should be available from the System Administrator.

- **Local** time is the time being used by the remote user interface; it is the local PC time. It is referenced to UTC (Coordinated Universal Time) and may be offset to allow for local time variations, for example, British Summer Time = +60 minutes. The adjusted time is shown. Local time corresponds with the current Windows clock and time zone parameters.
- **RTM Device** time is the time being used by the RTM device; this may be in a completely different time zone. It is referenced to UTC (Coordinated

Universal Time) and may be offset to allow for local time variations, for example, British Summer Time = +60 minutes. The adjusted time is shown.

With **Real Time Clock** selected from the **Time Source** drop-down list, the RTM device can be synchronized to local PC time using **Sync with Local**. Any offset required (for a different time zone) is entered in the **UTC to Time Zone Offset** field in minutes (range: ± 12 hours) and activated using **Set**.

NOTE. *There may be a slight delay between the RTM device time displayed and the actual time on the device due to network delays incurred in retrieving the time. This is most likely to be seen if you apply **Sync with Local** and observe that the **Local and RTM Device times are slightly out of step.***

With either **Longitudinal Time Code** or **Simple Network Time Protocol** selected from the **Time Source** drop-down list, the RTM device takes its time from the respective input. Any offset required (for a different time zone) is entered in the **UTC to Time Zone Offset** field (in minutes) and activated using **Set**.

To use a remote time server, **Simple Network Time Protocol** should be selected from the **Time Source** drop-down list, and the IP address of a suitable SNTP server entered in the **SNTP** field.

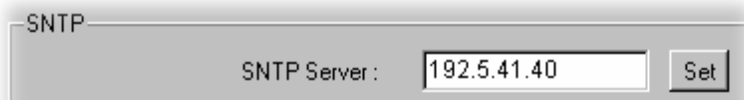

The image shows a screenshot of a software interface for configuring the SNTP field. The label "SNTP" is positioned at the top left of the configuration area. Below it, the text "SNTP Server :" is followed by a text input field containing the IP address "192.5.41.40". To the right of the input field is a button labeled "Set".

The network Gateway and Subnet Mask must be set up for the remote server to be able to communicate (see *Network Settings*, page 3-7).

Firmware Upload

If new device or interface card firmware is available, this function allows you to upload it to the respective device. The firmware filename format is *.hex.

Device Firmware Upload.



CAUTION. *The Device Log must be cleared immediately before uploading the firmware.*

1. Clear the Device Log.
2. Select **Upload Device Firmware.**

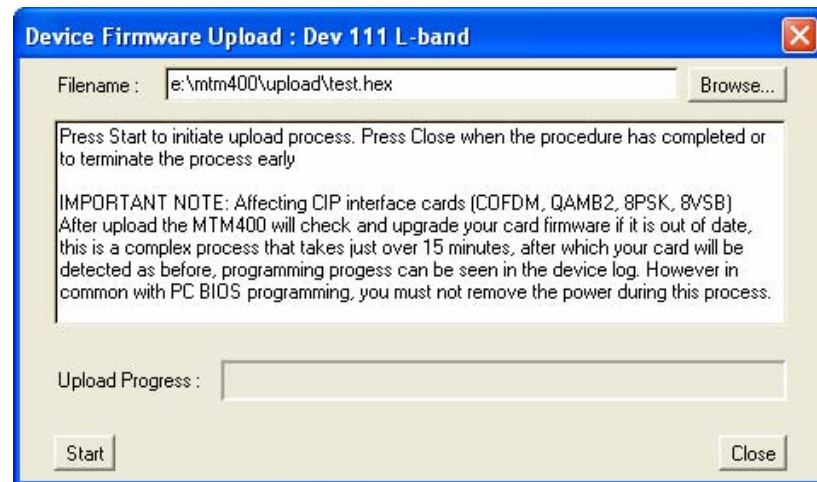

3. Identify the firmware file either by entering the path and filename or by using **Browse.**
4. Select **Start** to upload the firmware.



CAUTION. *If the instrument contains a CIP interface card (COFDM, QAMB2, 8PSK, 8VSB), the upload process can take up to 15 minutes to complete. The operation will fail if power is removed during this process.*

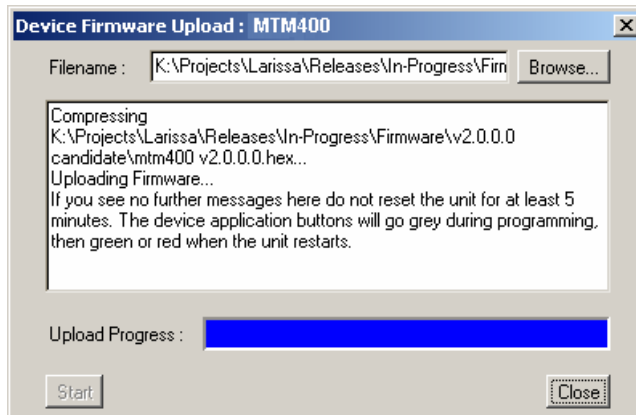

5. Select **Close** when the process has completed or to terminate the process.

Interface Card Firmware Upload.

NOTE. *This feature will only be used for interim updates of the Interface Card Firmware. The update will comprise up to three files. Documentation specifying Card Type and ROM number to be used will be supplied with the firmware files.*

The firmware is uploaded to non-volatile RAM on the card. If this firmware becomes corrupted and the device needs to be reprogrammed, the original firmware from the MTM400 will be used; the updated firmware would have to be reapplied.

1. To upload interface card firmware, select **Upload I/F Card Firmware**.

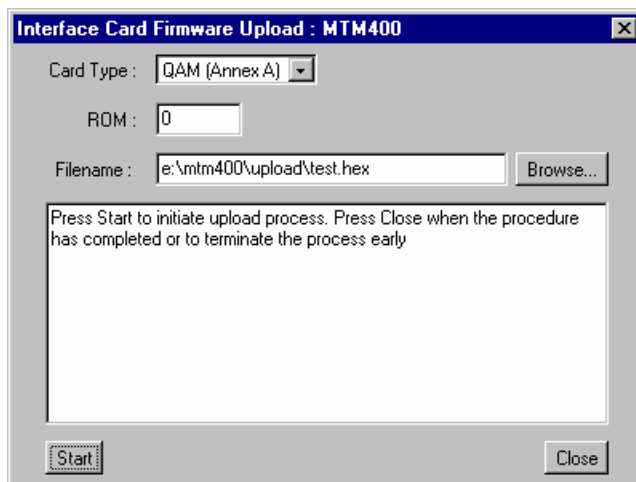

2. Select the **Card Type** to which the firmware is to be uploaded from the drop-down list.
3. Enter the **ROM** number (0, 1 or 2).

4. Identify the firmware **Filename**: (either by entering the path and filename or using **Browse**).
5. Select **Start** to upload the firmware.

Select **Close** when the process has completed or to terminate the process.

Passwords

Use the Password feature in the device configuration to change the current password. This is the password that will be required when you access the device through the RUI. The password file created is stored on the RTM device.

Note that only users with administrator access can change the RUI passwords.

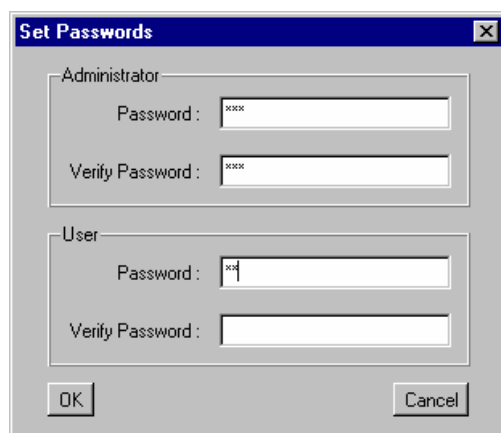

The screenshot shows a 'Set Passwords' dialog box with the following fields and values:

Section	Field	Value
Administrator	Password	xxxx
	Verify Password	xxxx
User	Password	xxx
	Verify Password	

1. For the administrator, enter a password in the **Password** field. Verify it by entering it again in the **Verify Password** field.
2. Repeat for the user.
3. Select **OK** to confirm the passwords.

Device Reset

Selecting **Reset Device** resets the RTM device; it is equivalent to removing and reinstating power. The configuration is reloaded from non-volatile RAM; any configuration settings applied in the preceding few seconds may not be saved so if you have changed settings wait a few seconds before resetting the box. The device configuration is reloaded from non-volatile RAM upon restart.

Upload License

A license key is applied to each RTM device to enable functionality. When new or upgraded functions are added, for example as part of a field upgrade, you will receive a new license key with the upgrade kit. Use the **License Upload** dialog to apply the new license key.

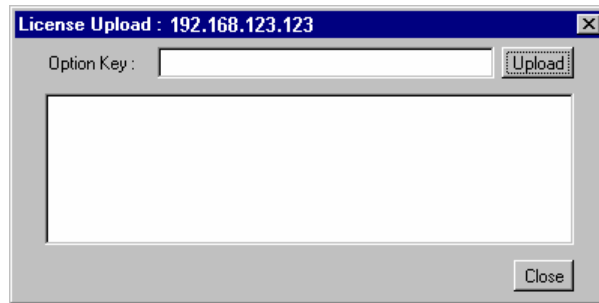

Enter the new License Key; this will accompany the upgrade documentation. Select **Upload**. The result will be displayed.

The license key will be stored on the RTM device. Note that licensing is specific to a single RTM device.

Device Information

The Info view details the software and hardware build state of the MTM400. (The values shown in this example will differ from the values shown on your display.)

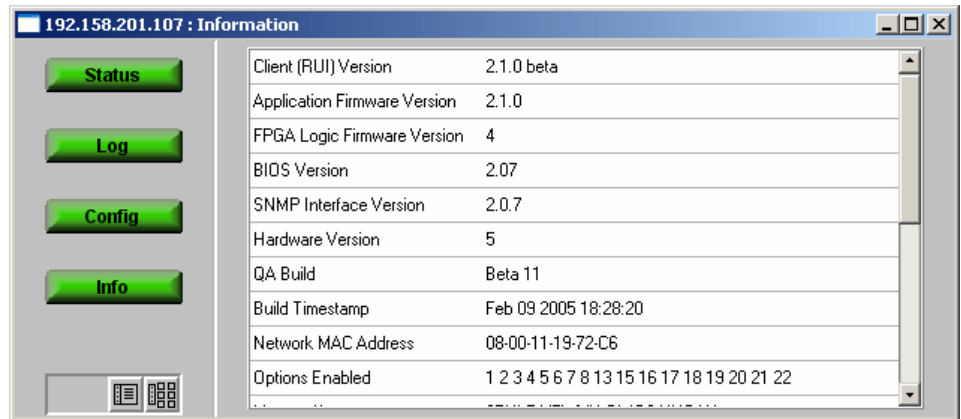

Figure 3-5: Device view - Information

SNMP

The MTM400 Simple Network Management Protocol (SNMP) agent is a software process that responds to queries using the SNMP to provide status and statistics about the MTM400. This enables management applications to be developed that can access MTM400 units remotely across a network using SNMP.

Each of the events available from the MTM400 is kept in a database described by a Management Information Base (MIB). The various values that can be retrieved from the MIB are called *MIB variables*. These variables are defined in the MIB for the MTM400. Each MIB variable is named by an *Object Identifier* (OID).

The MTM400 MIB is documented in the *MTM400 MPEG Transport Stream Monitor Programmer Manual*, Tektronix part number 071-1375-xx.

The MTM400 MIB definition files can be downloaded from the MTM400 using <http://address/mib/adsys.mib> and <http://address/mib/admpeg.mib>.

Communities

An SNMP Community String is like a password. It is sent along with each SNMP request and allows (or denies) access to the MTM400. Most agents accept a default password of “public”. Alternative community strings can also be used to enhance security. The MTM400 uses the standard community string “public”. However, it allows a secondary community string to accommodate older systems that use different values and cannot be changed. Even if these values are changed, the “public” community string can still be used. Read and Write community strings can be set in the **Network Settings** dialog (see page 3-7).

SNMP Traps

An SNMP Trap is an unsolicited message from an MTM400 to an SNMP agent that an event has occurred. Traps provide an immediate notification for an event that might only be discovered during occasional polling using normal SNMP techniques.

SNMP traps have a default community string of “public”. An alternative community string can be assigned in the **Network Settings** dialog (see page 3-7).

Stream View

The Stream view provides information about the monitored stream.

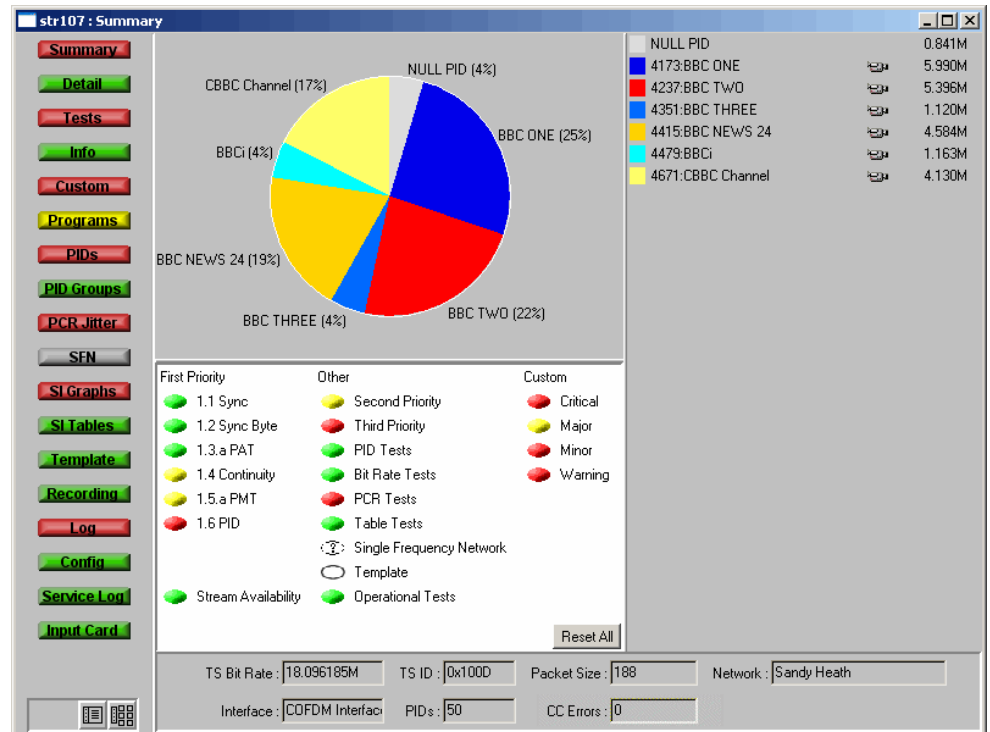

Figure 3-6: Stream view

The title bar displays the Stream Name (configured by the user), and the current view type.

The information takes the form of a series of screens; a brief summary of each follows:

- Summary** A dynamic visual overview of the stream and monitoring status. The information is updated at regular intervals. (See page 3-20.)
- Detail** Displays the detailed information about the stream according to SI tables, PIDs, or Program. (See page 3-22.)

Tests	Displays the state of the tests applied to the stream. It also allows users with read-write permissions (Administrators) to configure alarms and relays and parameters associated with each test. (See page 3-23.)
Information	Displays events not normally logged in the Stream log; for example, PAT/PMT version changes. (See page 3-28.)
Custom	Displays the state of the tests in the same way as the Tests view, but categorized as Critical, Major, Minor or Warning. The allocation of tests to categories is preconfigured, but you can override the settings at run time. However, the settings will not be saved when the RUI is closed (using the WebMSM allows permanent configurations to be saved). (See page 3-26.)
Programs	Displays the programs that are being transmitted on the stream along with bit rate and the minimum and maximum bit rates that are observed. Administrators can set bit rate limits for each program if the bit rate limits option is licensed. (See page 3-30.)
PIDs	Displays the PIDs that are being transmitted on the stream along with bit rate and the minimum and maximum bit rates that are observed. Administrators can set bit rate limits for each PID if the bit rate limits option is licensed. (See page 3-34.)
PID Groups *	Displays the PID groups that you have created. The displayed information includes the error state and the bit rate. (See page 3-41.)
PCR Jitter *	Displays the following PCR graphs: Inaccuracy, Arrival, Overall Jitter, Frequency Offset, and Drift Rate. (See page 3-48.)
SFN	Displays the Single Frequency Network (SFN) information when available. (See page 3-56.)
TMCC	Displays the Transmission and Multiplexing Configuration Control (TMCC) and IIP information when available. (Only available for ISDB streams) (See page 3-57.)

SI Graphs *	Displays information about repetition rates of SI tables and subtables in graphical format. (See page 3-58.)
SI Tables *	Displays the SI Information for the stream. (See page 3-62.)
Template *	Displays the structure and status of templates applied to the stream. (See page 3-68.)
Recording *	Displays the Triggered Recording setup screen. (See page 3-71.)
Log	Displays the stream log. (See page 3-72.)
Config	Displays general configuration parameters for the stream. Administrators can modify certain parameters. Scheduling, triggered recording, and interface setup are configured here. (See page 3-76.)
Service Log	Displays the Service Log. Service logging allows packet counts for specified PIDs (range: 0 to 100) to be collected at a user-definable interval. (See page 3-80.)
Input Card	Displays the relevant graphs and setup of any installed interface card. (Only displayed if an interface card is present.) (See page 3-107.)

* - licensed options (see Table 1-5: MTM400 Options Summary).

Monitoring Overview Screen (Summary Screen)

This screen provides a dynamic visual overview of the stream and monitoring status. The information is updated at regular intervals.

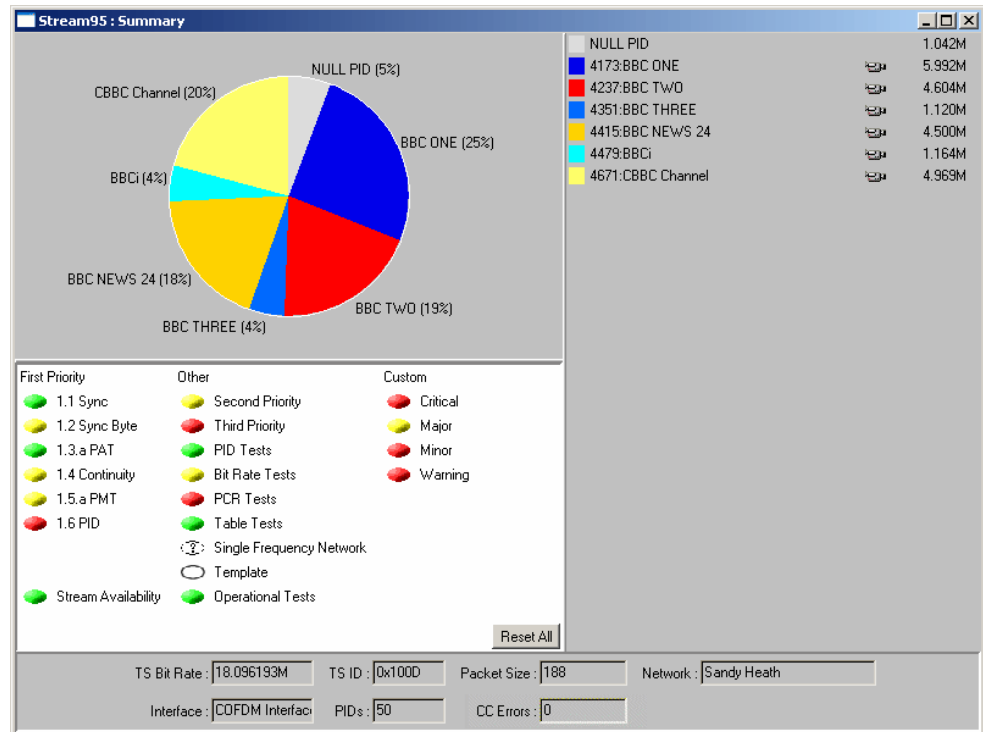

Figure 3-7: Stream view - Overview

The upper half of the Overview screen displays service information in the form of a pie chart and a list. Services are named and color coded to allow correlation between the pie chart and the list. The pie percentage value of the NULL PID relates to the stream bitrate. The services are divided pro-rata over the total effective bitrate of all the active services in the stream (due to PID reuse the total effective bitrate may be greater than the transmitted stream bitrate), this ensures that the NULL PID bitrate shows the true available bandwidth. Bit rates of individual services are given in the service list. The icons in the service list give an indication of the program content: video, audio or data.

The lower half of the screen displays an overview of the tests applied to the stream. The tests are grouped as follows:

First Priority: Lists the first priority tests in DVB, ISDB or ATSC order.

Other: Summarizes all test groups except First Priority. The groups are derived from the Tests screen (see page 3-23).

Custom: Represents the highest error state present in the events associated with the category. (These can be edited on the *Custom screen*, see page 3-26.)

The button to the left of the test name shows the current error status of the individual test or, in the case of test groups, the highest error state reported by any test within that group (see also *Color Coding*, page 2-11).

All tests can be reset using **Reset All**.

The Stream State summary table shows the overall status of the stream in terms of error severity and event classification.

A summary of stream statistics is provided at the bottom of the screen. The fields are as follows:

TS Bit Rate:	Overall bit rate of stream.
TS ID:	Transport stream identity; derived from the Program Association Table (PAT).
Packet Size:	Transport stream packet size (188/204).
Network:	Network name; derived from the Network Information Table (NIT) in the stream.
Interface:	Indicates the interface selected. (see <i>Configuration Screen</i> , page 3-76.)
PIDs:	Number of Packet Identifiers (PIDs) in the transport stream.
BER:	Bit Error Rate (Only displayed with L-Band (QPSK) or QAM interfaces).

Detail Screen

This screen provides a dynamic, detail view of the stream PIDs. The information is updated at regular intervals.

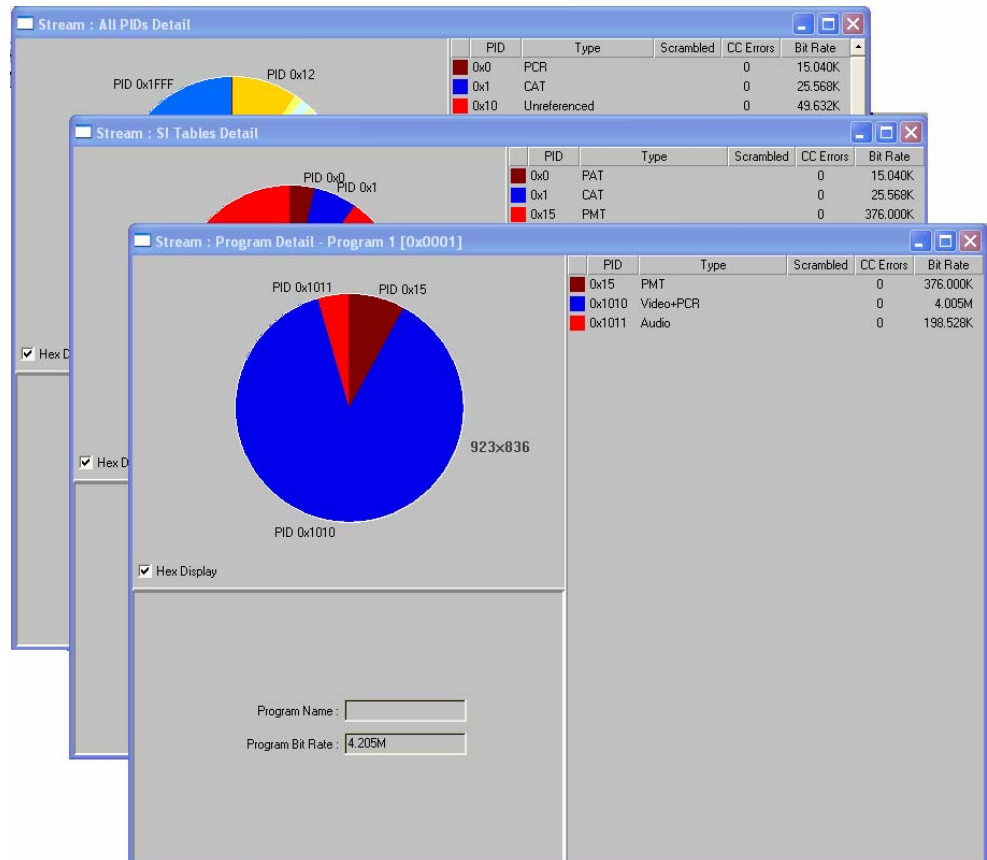

Figure 3-8: Stream view – Detail

The Detail screen button offers three options. **All PIDs** displays details of all the PIDs in the stream. **SI Tables** displays details of only those PIDs that are carrying service information table information. **Programs...** allows you to select a single program and display details of the associated PIDs.

Tests Screen

The Tests screen displays the results of tests on the current stream grouped in DVB, ISDB or ATSC priority order. Additional proprietary tests are grouped by function; for example, Bit Rate tests and PID Tests.

State	Error	Alm	TTL1	TTL2	TTL3	T-	T+	RLY1	RLY2	RLY3	RLY4	RLY5	Rec
	Any Stream Error												
	Transport Stream Available												
First Priority													
	1.1 Sync												
	1.2 Sync Byte												
	1.3.a PAT												
	1.4 Continuity												
	1.5.a PMT												
	1.6 PID												
Second Priority													
	2.1 Transport												
	2.2 CRC												
	2.3.a PCR Repetition												
	2.3.b PCR Discontinuity Indicator												
	2.4 PCR Accuracy												
	2.5 PTS												
	2.6 CAT												
Third Priority													
	3.1.a NIT Actual												
	3.1.b NIT Other												
	3.2 SI Repetition												

Figure 3-9: Stream view - Tests

A full list of tests and their associated parameters is given in the *MTM400 MPEG Transport Stream Monitor Programmer Manual*.

The Tests and Custom screens provide the same information prioritized in different ways.

In addition to providing an overview of the stream status, up to four types of alarm can be activated when an error on a test occurs. The alarms may be:

	An internal audible alarm.
	A TTL output on the rear of the unit, allocated to the stream.
	An SNMP (Simple Network management Protocol) trap event.
	One or more relay outputs on the rear of the unit, allocated to the stream.

The alarm output specifications are given in *MTM400 MPEG Transport Stream Monitor Technical Reference Manual*.

Each test can be enabled/disabled by double-clicking the appropriate icon.

Only administrators can set parameters, enable and disable tests and set alarms.

The button (State) to the left of the test name (Error) shows the current status of the test (see *Color Coding*, page 2-11).

The screen contains the following information:



Title Bar The title bar of the screen displays the name of the stream under test. (Assigned on the Stream Configuration screen, page 3-74).

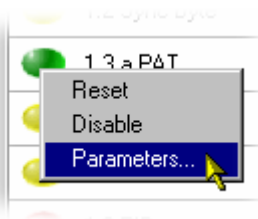

State Icon showing the state of the event:
When you right-click on this icon, it will open a popup menu that will allow you to Reset the error, Disable/Enable monitoring of this event, or adjust the parameters of the test.





Double-clicking the icon will disable/enable the event monitoring.

Error Name of the event (for example, 1.1 Sync). The names are those allocated by the standards (DVB, ASTC, ISDB or proprietary).



Alarm (Alm) Off - ; On - ;
Indicates whether an audible alarm will sound when an error occurs. Double-click this icon to toggle its state: enabled or disabled.

TTL (TTL1, TTL2 and TTL3) Off - ; On - ;
Indicates whether a TTL output will activate when an error occurs. Double-click this icon to toggle its state: enabled or disabled.

SNMP (T- and T+) Off -  (gray); On -  (yellow);
Indicates whether SNMP trap messages should be sent when a specific event starts and finishes.

Relay (RLY1 to RLY5) Off - ; On - .

Indicates whether a relay will activate when an error occurs. Double-click the icon to toggle its state: enabled or disabled. Five relays are available (**Rly1**, **Rly2**, **Rly3**, **Rly4** and **Rly5**). The relay connections are given in the relevant RTM device user guide.

Rec Off - , Set - .

This icon, when active, indicates that the test has been selected as a trigger for recording a stream. To select a test, double-click the icon in the Rec column; an activated icon is red; an inactive icon is a clear circle.

This icon is only displayed if Triggered Recording (Option 01) is licensed for use.

The Triggered Recording parameters are set up from the *Configuration Screen* (see page 3-76).

Test Parameters

Many tests are associated with parameters recommended by the standard (DVB, ATSC, ISDB) being applied to the stream. The parameters can be adjusted to suit local conditions (although the test result may then not conform to the standard).

The parameters dialogs are accessed by right-clicking on the error **State** icon of the required test and selecting **Parameters....** An example dialog is shown below:

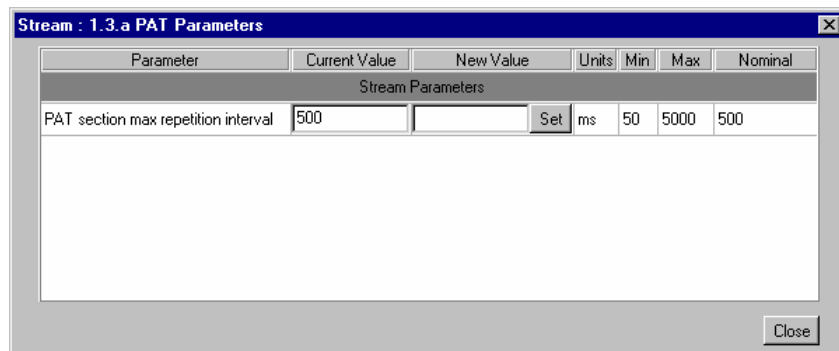

Tests and Parameters are fully described elsewhere (see the *MTM400 MPEG Transport Stream Monitor Programmer Manual*).

Custom Screen

State	Error	Alm	TTL1	TTL2	TTL3	T-	T+	RLY1	RLY2	RLY3	RLY4	RLY5	Rec
Critical Events													
●	Any Stream Error	⊘	▶	▶	▶	⚡	⚡	Ⓞ	Ⓞ	Ⓞ	Ⓞ	Ⓞ	Ⓞ
●	1.2 Sync Byte	⊘	▶	▶	▶	⚡	⚡	Ⓞ	Ⓞ	Ⓞ	Ⓞ	Ⓞ	Ⓞ
●	2.1 Transport	⊘	▶	▶	▶	⚡	⚡	Ⓞ	Ⓞ	Ⓞ	Ⓞ	Ⓞ	Ⓞ
●	3.1.a NIT Actual	⊘	▶	▶	▶	⚡	⚡	Ⓞ	Ⓞ	Ⓞ	Ⓞ	Ⓞ	Ⓞ
●	PCR Jitter	⊘	▶	▶	▶	⚡	⚡	Ⓞ	Ⓞ	Ⓞ	Ⓞ	Ⓞ	Ⓞ
●	Processing Overwhelmed	⊘	▶	▶	▶	⚡	⚡	Ⓞ	Ⓞ	Ⓞ	Ⓞ	Ⓞ	Ⓞ
Major Events													
●	2.2 CRC	⊘	▶	▶	▶	⚡	⚡	Ⓞ	Ⓞ	Ⓞ	Ⓞ	Ⓞ	Ⓞ
●	2.4 PCR accuracy	⊘	▶	▶	▶	⚡	⚡	Ⓞ	Ⓞ	Ⓞ	Ⓞ	Ⓞ	Ⓞ
○	3.1.b NIT Other	⊘	▶	▶	▶	⚡	⚡	Ⓞ	Ⓞ	Ⓞ	Ⓞ	Ⓞ	Ⓞ
●	3.5.a SDT Actual	⊘	▶	▶	▶	⚡	⚡	Ⓞ	Ⓞ	Ⓞ	Ⓞ	Ⓞ	Ⓞ
●	3.6.b EIT Other	⊘	▶	▶	▶	⚡	⚡	Ⓞ	Ⓞ	Ⓞ	Ⓞ	Ⓞ	Ⓞ
●	Transport Stream Occupancy	⊘	▶	▶	▶	⚡	⚡	Ⓞ	Ⓞ	Ⓞ	Ⓞ	Ⓞ	Ⓞ

Figure 3-10: Stream view - Custom

The Tests and Custom screens provide the same information prioritized in different ways. In the Custom screen, test results for the current stream are grouped in Event Classification order. Setting up the Event Classification is described below.

All fields in the view are as described in the *Test screen* section (page 3-23).

Only users logged on as Administrators can set parameters, enable and disable tests and set alarms.

Stream Event Classification

The Stream Event Classification dialog is opened by selecting the **Custom Classifications...** button in the Custom view.



The dialog box allows the associated Event Classification file to be temporarily modified. All changes made will be lost when the current session is ended by closing the MTM400. (When accessed via the WebMSM, these changes are saved.)

The dialog box allows each error event to be designated in one of four categories: Critical, Major, Minimal or Warning. The list of events presented in the dialog will reflect the stream standard (DVB, ISDB and ATSC) notified by the RTM device. Some proprietary tests may also be listed. The classifications set are used in the stream summary screen to show the overall status of the stream.

Select the **Close** button to retain the temporary settings and close the dialog.

Information Screen

The Information screen displays stream events and messages.

Stream events and messages may be logged but do not constitute a test failure; for example, a version change of a table carried in the SI/PSI is reported in the stream log but is not subject to a standard test. The only place that these stream events are recorded is in the stream logs. This screen collects these all in one place and allows their recording in the stream log to be enabled or disabled. Alarms can be raised when a message occurs.

The messages to be displayed are set at the factory; interface cards can also generate messages.

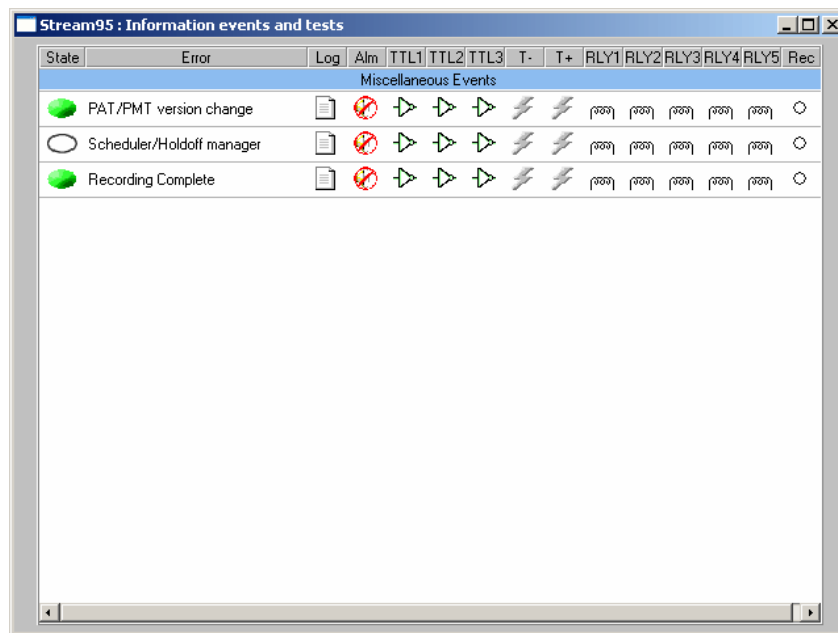



Figure 3-11: Stream view - Information

The layout and functionality is similar to the Tests screen; a single column of icons is added, that is **Log**.







Log Off - ; On - ;
Enables/disables message recording in the stream log.
Double-click this icon to toggle its state: enabled or disabled.

Right-click the error LED to set parameters, enable and disable tests and set alarms.

State Icons

The State icons used in the Information screen are as shown in Table 3-1:

Table 3-1: Button colors - Information view

Icon	Color	Meaning
	Green	Idle - the event is not happening at this time.
	Blue	Event detected and still present.
	Yellow	Transient message, which has now corrected itself.
	Gray	The event has been disabled (or is unavailable). All buttons gray indicates that connection to a device has been lost.
	White	Test not applicable. For example, PCR tests when the program clock reference is not carried by any PIDs in the stream.
	Clear / ?	Test state unknown or incomplete. For example, during an RF measurement settling period.
	Black	Maintenance mode.

Programs Screen

The Programs screen provides a quick overview of the program contents of a transport stream.

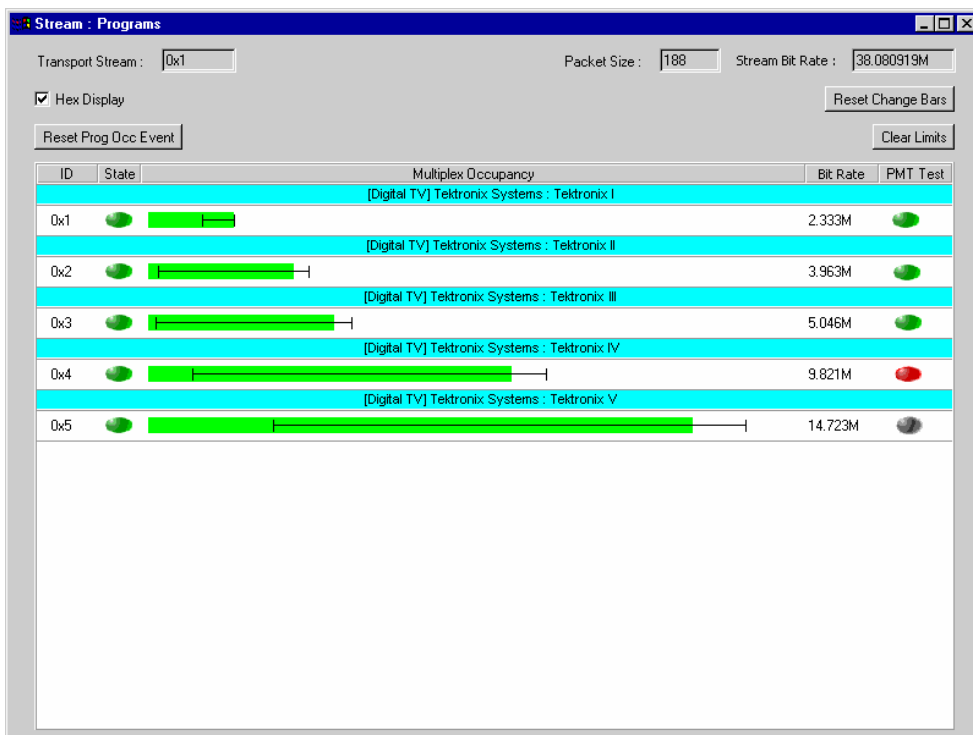

Figure 3-12: Stream View - Programs

In this view, all the programs detected in the incoming transport stream are displayed. Each displayed program is accompanied by:

- Program name (Divider bar)
- Program ID
- Error state (only displayed if Bit Rate Testing - Option 05 - is licensed for use)
- Program bit rate (graphically and numerically)
- PMT Test

Also displayed, at the top of the view, are the transport stream ID, the packet size, and the total stream bit rate.

The view contains the following elements (more detailed descriptions follow):

Title Bar	The title bar of the screen displays the name of the stream under test (assigned on the <i>Configuration Screen</i> (see page 3-76).
Transport Stream:	The transport stream identity.
Packet Size:	The transport stream packet size.
Stream Bit Rate:	The total bit rate of the stream.
Hex Display	If enabled, the Transport Stream ID and the program ID are displayed in hex format. If disabled, they are displayed in decimal format.

Table:

Program ID (ID): The program number.

Program Occupancy Status (State):*
Indicates the Program Occupancy test error state for the program.

Program Bit Rate (Multiplex Occupancy):*
A graphical representation of the program bit rate. The bar color indicates the error status of the program bit rate. Superimposed on the bar are the Change Bar and (where set) the limits (see **Clear Limits** below).

Program Bit Rate (Bit Rate):
The program bit rate in bits per second.

PMT Test: Shows the PMT Test result (see page 3-33).

Buttons:

Reset Change Bars *
Resets the Change Bars of all programs.

Reset Prog Occ Event *
Resets the proprietary Program Occupancy test normal state (no error).

Clear Limits * Resets and disables the Bit Rate Limits of all programs.

* - only displayed if Bit Rate Testing (Option 05) is licensed for use.

Only administrators can adjust bit rate limits.

Bit Rates

The program bit rate (**Bit Rate**) shows the sum of the individual bit rates for all the PIDs that make up the program.

NOTE. *It is possible that in certain transport streams, different programs may reference a single PID; for example, programs may reference one PCR PID. In these cases, the PID bit-rate will be included in all the programs from which the PID is referenced. Therefore the total bit-rate of all the programs may add up to more than the total stream bit rate displayed at the top of the window.*

Change Bar

The Change Bar indicates the variation of bit rates in each program. The ends of the Change Bar show the maximum and minimum values of the bit rate since monitoring started or since the change bars were last reset.

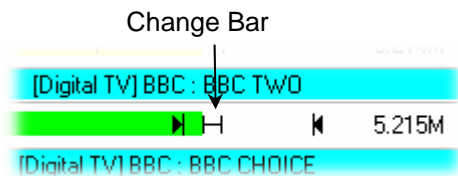

The Change Bar on *all* programs can be reset by selecting the **Reset Change Bars** button at the top of the Programs screen.

Bit Rate Limits

For each program it is possible to set a minimum (⏪) and maximum (⏩) bit rate limit. If the incoming bit rate falls outside the values that have been set, an alarm is indicated on the screen by a color change in the graphical bit rate bar; the Program Occupancy test and state icon on the Tests view are also set. This test can also activate the external alarm outputs. When enabled, the limits appear as in the preceding diagram shown above.

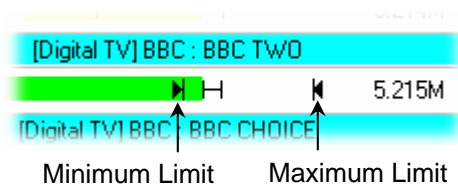

The maximum and minimum bit rate limits are set in the **Limits** dialog. Click on the program bar to open the dialog box:

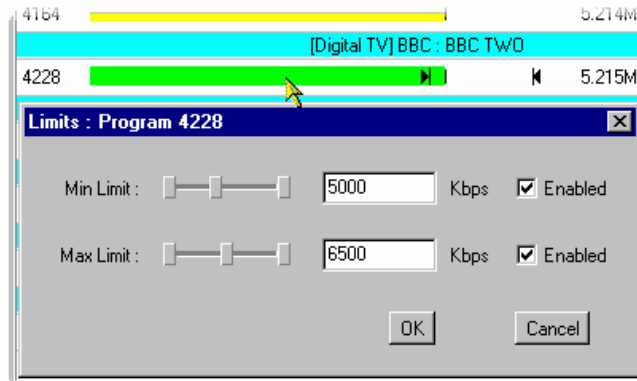

Only users logged on as Administrator can adjust bit rate limits. Users logged on as **User** can only view the limits.

The maximum and minimum values can be set either by using the appropriate slider bar or by entering a value in the numeric field. Values are expressed in kilobytes per second. The **Enabled** checkbox must be selected before the limit will be implemented. To confirm the settings select the **OK** button; to discard any changes, select the **Cancel** button.

The Bit Rate Limits of *all* programs in a stream can be disabled and reset by selecting the **Clear Limits** button at the top of the Programs screen.

PMT Test

The PMT column shows the results of the PMT test (MPEG Test 1.5) for specific programs; green indicates a pass, red indicates a fail, and yellow indicates a previous fail. Normally the test is enabled for all of the programs in a stream, but programs with known problems can be excluded by right-clicking the test button and selecting **Disable**; the button is colored gray.

PIDs Screen

The PIDs screen provides an overview of the PIDs contained in a transport stream sorted by program.

PID	Test	CC Errors	Scrambled	Type	Multiplex Occupancy	Bit Rate
Program 1 (0x1)						
0x15	Any PID Error	0		PMT	[Progress Bar]	376.000K
0x1010	Any PID Error	0		Video+PCR	[Progress Bar]	3.999M
0x1011	Any PID Error	0		Audio	[Progress Bar]	198.528K
Program 27 (0x1B)						
0x15	Any PID Error	0		PMT	[Progress Bar]	376.000K
0x1030	Any PID Error	0	Scrambled	Video+PCR	[Progress Bar]	5.981M
0x1031	Any PID Error	0	Scrambled	Audio	[Progress Bar]	136.864K
0x23	Any PID Error	0	Scrambled	ECM	[Progress Bar]	15.040K
Program 28 (0x1C)						
0x15	Any PID Error	0		PMT	[Progress Bar]	376.000K
0x1050	Any PID Error	0	Scrambled	Video+PCR	[Progress Bar]	5.938M
0x1051	Any PID Error	0	Scrambled	Audio	[Progress Bar]	135.360K
0x1053	Any PID Error	0		Teletext	[Progress Bar]	178.976K
0x21	Any PID Error	0	Scrambled	ECM	[Progress Bar]	15.040K
Other Pids in the Multiplex						
0x1	Any PID Error	0		CAT	[Progress Bar]	25.568K
0x10	Any PID Error	0		Referenced	[Progress Bar]	49.632K

Figure 3-13: Stream view - PIDs

In this view, all the PIDs detected in the incoming transport stream are displayed. The PIDs are grouped by program; PIDs not associated with specific programs are displayed in numerical order below the program listings under the section title **Other PIDs in the Multiplex**.

The view contains the following elements (a more detailed description follows where necessary):

- Title Bar** The title bar of the screen displays the name of the stream under test (assigned on the *Configuration screen*, page 3-74).
- Transport Stream:** The transport stream identity.
- Packet Size:** The transport stream packet size.

- Stream Bit Rate:** The total bit rate of the stream.
- Hex Display** If enabled, the Transport Stream ID and the PID identities are displayed in hex format. If disabled, they are displayed in decimal format.
- Test:** Allows specific tests, selected from the drop-down list, to be applied to all of the PIDs in the stream. The state of the test is indicated for each PID by the **Test** icon. If a test is not relevant to a PID, the test is disabled for that PID; the **Test** icon indicates this.

The tests shown below are those that can be applied to each PID where appropriate:

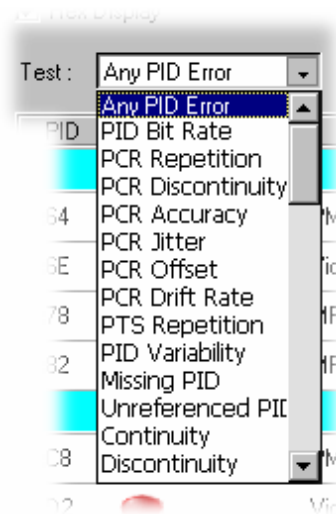

(See *Test Selection*, page 3-40)

Table

PID The PID number carrying the data.

Test Icon showing the state of the currently selected PID test:

Right-click this icon to open a popup menu that allows you to reset the error, disable or enable monitoring of this event, or adjust the parameters of the test.

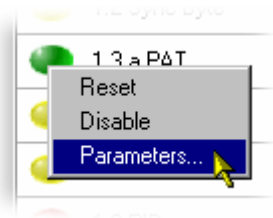

Double-clicking the icon will disable/enable the event monitoring.

Scrambled

A key icon  is shown adjacent to conditional access tables, for example, EMM/ECM.

A padlock icon  is shown if the PID is scrambled.

Type

The data type carried by the PID, for example, Video+PCR, MPEG Audio.

Multiplex Occupancy

A graphical representation of the PID bit rate. The bar color indicates the error status of the PID. Superimposed on the bar are the Change Bar and (where set) the limits (see **Clear Limits** below). The graphic is displayed in the color according to whether there are any PID errors (if a set limit has been exceeded).

Note that the graphical representation and section Title bar is changed when PID Variability is selected (see *Test Selection*, see page 3-40).

Bit Rate

The PID bit rate in bits per second.

Buttons

Reset Change Bars Resets the Change Bars of all programs.

Clear Limits * Resets and disables the Bit Rate Limits of all programs.

User PIDs Allows you to add PIDs to the displayed list.

Reset All Resets the selected test for all PIDs.

* - only displayed if Bit Rate Testing (Option 05) is licensed for use.

The **Stream Bit Rate** shows the sum of the individual PID bit rates that make up the stream. The PID bit rate (**Bit Rate**) shown for each PID is that for the individual PID.

Only users logged on as Administrators can adjust bit rate limits.

Change Bar

The variation of bit rate in each PID is indicated by a Change Bar (except when PID Variability is selected). The ends of the Change Bar show the maximum and minimum values of the bit rate since monitoring started or since the change bars were last reset.

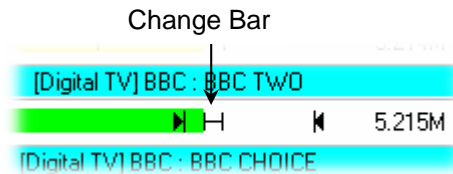

The Change Bar on *all* PIDs can be reset by selecting the **Reset Change Bars** button at the top of the PIDs screen.

Bit Rate Limits

For each PID you can set a minimum (⏪) and maximum (⏩) bit rate limit. If the incoming bit rate falls outside the values that have been set, an alarm is indicated on the screen by the graphical bit rate bar changing from green to red or yellow; the PID Occupancy test on the Tests view is also set. This test can also activate the external alarm outputs. When enabled, the limits appear as in the following diagram:

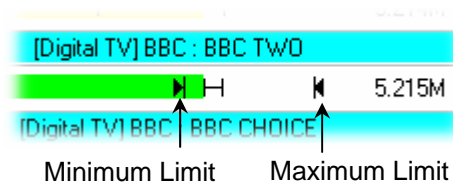

The maximum and minimum bit rate limits are set in the **Limits** dialog. Click on the program bar to open the dialog box:

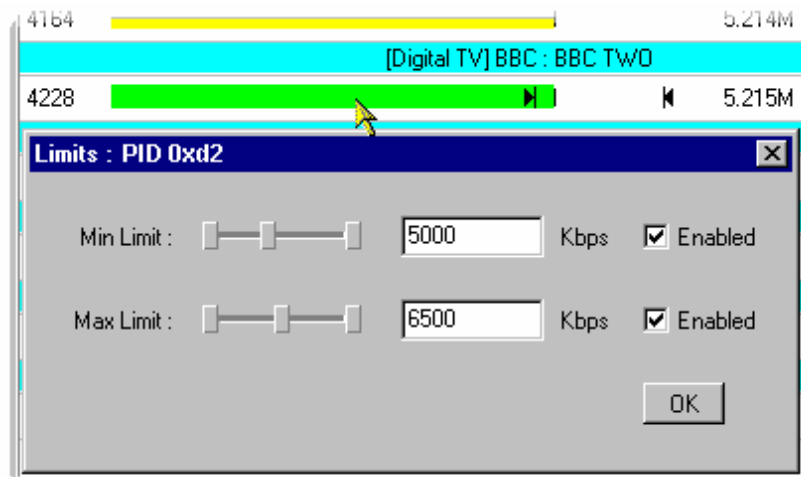

The maximum and minimum values can be set either using the appropriate slider bar or by entering a value in the numeric field. Values are expressed in kilobytes per second. The **Enabled** checkbox must be selected before the limit will be tested.

The Bit Rate Limits of *all* PIDs in a stream can be disabled and reset by selecting the **Clear Limits** button at the top of the PIDs screen.

User PIDs

You can add PIDs that are not automatically recognized in the stream to the display. The additional PIDs will appear in the **Other PIDs in the Multiplex** section of the display.

Adding a User PID.

1. From the PIDs screen, select **User PIDs...**

The **User PIDs** dialog box is displayed.

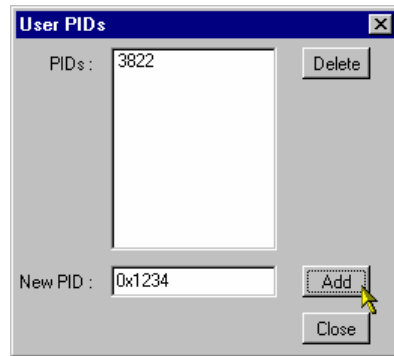

2. Enter the PID ID in the **New PID:** field.

The PID ID can be entered in either Hex (0xnxxx) or decimal (xxxx) format.

3. Select **Add**.

The PID ID will be displayed in the **PIDs:** list and subsequently in the PIDs view. It will be displayed in decimal format.

Deleting a User PID.

1. From the PIDs screen, select **User PIDs...**

The **User PIDs** dialog box is displayed.

2. In the **PIDs:** list, highlight the PID to be deleted.
3. Select **Delete**.

The selected PID will be removed from the list and subsequently from the main PIDs view.

Test Selection

The **Test:** drop-down list allows the user to select and apply specific tests to the PIDs in the stream. Tests on those PIDs to which the selected test is not applicable are disabled.

The following PID tests can be selected from the **Test:** drop-down list:

- Any PID Error
- PID Bit Rate *
- PCR Repetition
- PCR Discontinuity
- PCR Accuracy
- PCR Overall Jitter **
- PCR Frequency Offset**
- PCR Drift Rate **
- PTS Repetition
- PID Variability *
- Missing PID
- Unreferenced PID
- Continuity
- Discontinuity

* Require Bit Rate Testing to be licensed (License Option 05, Table 1-2: MTM400 options).

** Require PCR Testing to be licensed (see Table 1-2: MTM400 options).

The results of the tests are indicated by the **Test** icons. Where the test is inapplicable, the icon will be white.

For most of the tests, the parameters applied to each PID can be varied by right-clicking on the **Test** state button and selecting the **Parameters...** option.

Each of these tests and the associated parameters are described in the *MTM400 MPEG Transport Stream Monitor Programmer Manual*.

The results of tests applied here are not reflected in the PID Groups.

PID Groups Screen

PIDs can be grouped together to enable composite bit rate and test reporting of user-selected PIDs, perhaps carrying similar information. Up to 32 PID Groups can be formed. A maximum of 128 PIDs can be included in each of these 32 groups.

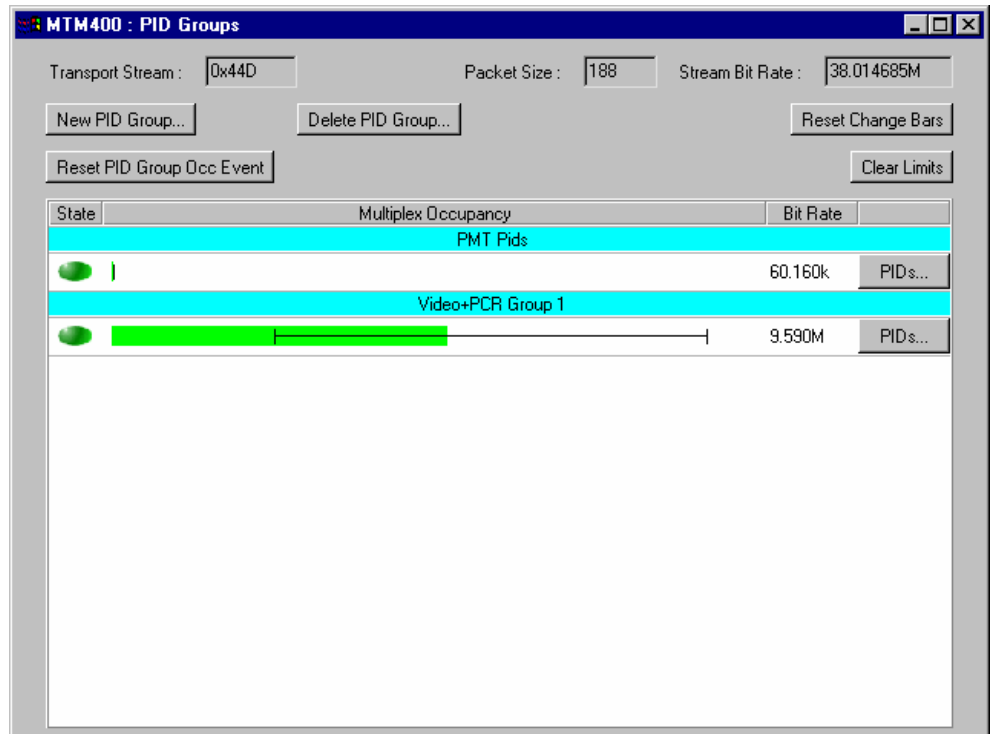

Figure 3-14: Stream view - PID groups

In this view, the PID Groups set up for the incoming transport stream are displayed. PID Group editing is performed using this screen.

Only users logged on as Administrator can adjust bit rate limits and modify the PID Groups.

The view consists of the following elements (a more detailed description follows where necessary):

Title Bar The title bar of the screen displays the name of the stream under test (assigned on the *Configuration Screen*, page 3-76).

Transport Stream: The transport stream identity.

Packet Size: The transport stream packet size.

Stream Bit Rate: The total bit rate of the stream.

Table

Each PID Group formed displays a title bar carrying the allocated name of the group. Each PID Group displays the following information:

State Icon showing the state of the PID Group (whether the bit rate limits are exceeded).

Multiplex Occupancy:

A graphical representation of the total bit rate of the PID Group. The bar color indicates the error status of the PID Group. Superimposed on the bar are the Change Bar and (where set) the limits (see below). The graphic is displayed in the color according to whether there are any PID Group errors (that a set limit has been exceeded).

Bit Rate: The PID bit rate in bits per second.

Buttons

New PID Group...

Opens a new (empty) PID Group, after a name has been allocated.

Delete PID Group...

Displays a list of all PID Groups and allows one or more to be deleted.

Reset Change Bars

Resets the Change Bars of all programs.

Reset PID Group Occ Event

Resets all PID Group errors. Note that this also resets the individual PID errors.

Clear Limits

Resets and disables the Bit Rate Limits of all programs.

PIDs...

(See *PID Group Management*, page 3-43.)

The **Stream Bit Rate** shows the sum of the individual PID bit rates that make up the stream. The bit rate (**Bit Rate**) shown for each PID group, is the sum of the grouped PID bit rates.

PID Group Management

This section describes how to add, edit, and remove PID Groups. Only an Administrator can add and delete PID Groups.

Adding a New PID Group. PID Groups are created in three stages:

- Identify the PIDs to be grouped.
- Create a new, named PID Group.
- Populate the new PID Group.

The procedure is as follows:

1. Use the PID screen to identify the PIDs to be grouped. The hex or the decimal PID can be used.
2. In the PID Group screen, select **New PID Group....**
3. Enter the PID Group name.



Select **OK**. Selecting **Cancel** will end the PID Group creation.

- The new PID Group is displayed in the PID Group screen:

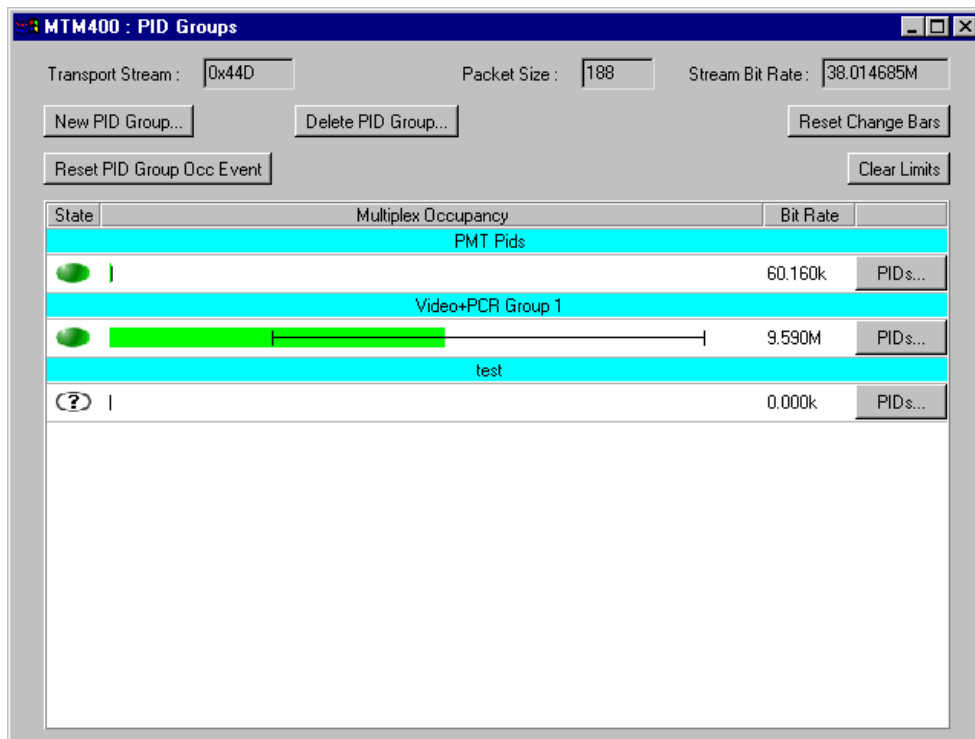

The new PID Group is empty and must be populated with PIDs.

- Select **PIDs...** from the new group title bar.

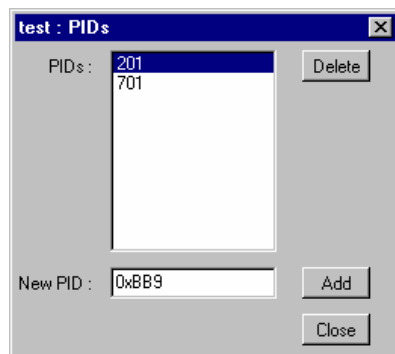

- In the **PIDs** dialog box and in the **New PID:** field, enter the identity of one PID in either hex (0xnnnn) or decimal (nnn) format.
- Select **Add**.
The PID is added to the **PIDs:** field.

8. Repeat the previous steps until all the PIDs to be included in the group have been added and are listed.
9. Select **Close** to close the dialog box. Display will begin immediately, confirming that the PID Group is operational.

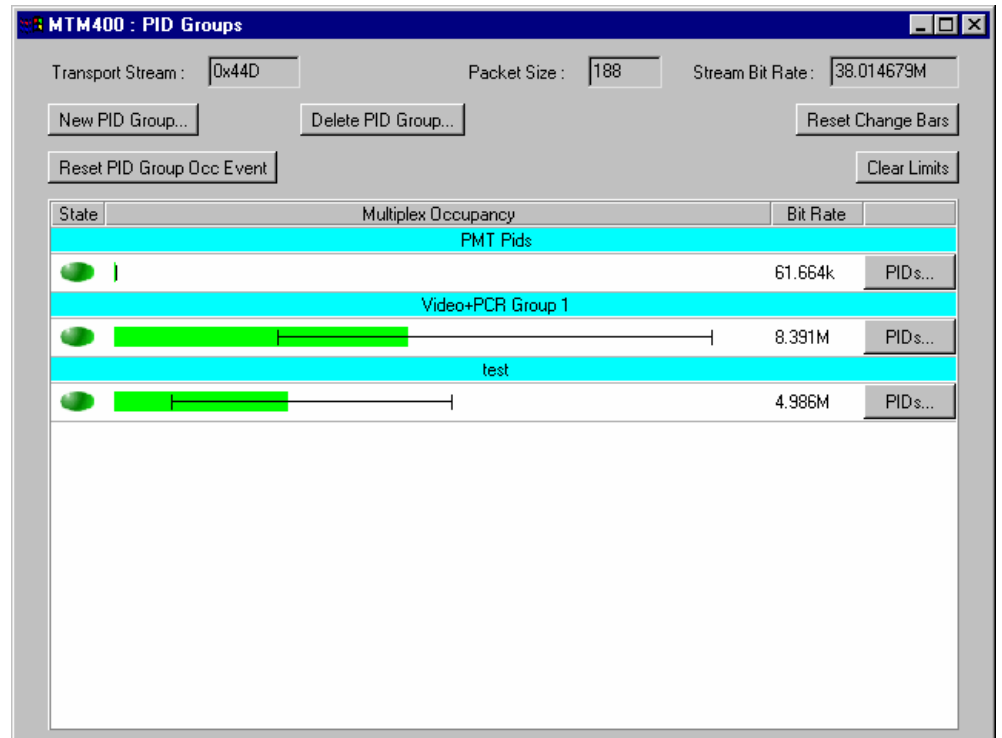

Editing a PID Group. To add or remove a PID from a PID Group, select **PIDs...** from the PID Group title bar.

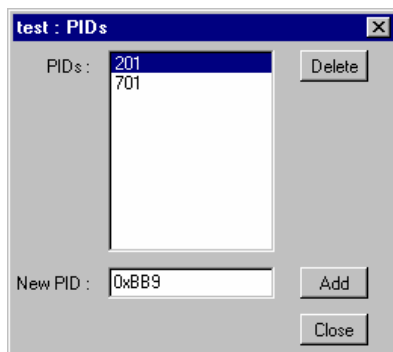

Delete removes the PID highlighted in the **PIDs:** field.
The PID is removed from the **PIDs:** field.

Add adds the PID identified in the **New PID:** field to the PID Group.
The PID is added to the **PIDs:** field.

Change Bar

The variation of bit rate in each PID is indicated by a Change Bar. The ends of the Change Bar show the maximum and minimum values of the bit rate since monitoring started or since the change bars were last reset.



The Change Bar on *all* PID Groups can be reset by selecting the **Reset Change Bars** button at the top of the PID Groups screen.

Bit Rate Limits

For each PID Group, you can set a minimum (M) and maximum (M) bit rate limit. If the incoming bit rate falls outside the values that have been set, an alarm is indicated on the screen by the graphical bit rate bar changing from green to red or yellow; the corresponding **State** icon is also set to the correct color. This test can also activate the external alarm outputs. When enabled, the limits appear as in the following diagram:

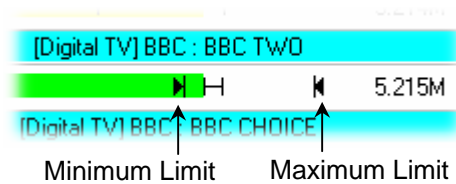

The maximum and minimum bit rate limits are set in the **Limits** dialog box; click on the program bar to open the dialog box:

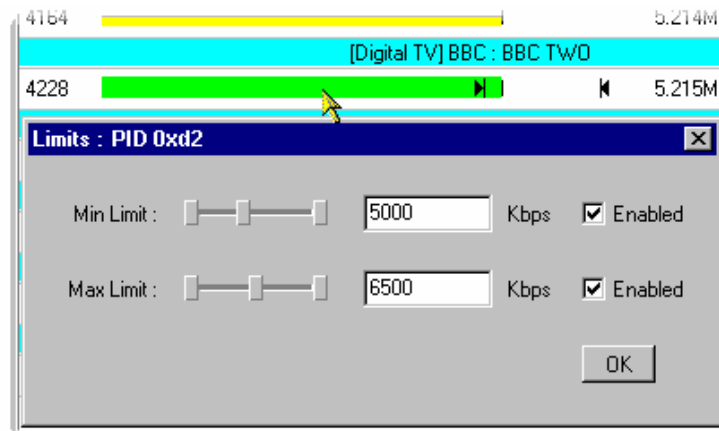

The maximum and minimum values can be set either by using the appropriate slider bar or by entering a value in the numeric field. Values are expressed in kilobytes per second. The **Enabled** checkbox must be selected before the limit will be implemented.

The Bit Rate Limits of *all* PID Groups can be disabled and reset by selecting the **Clear Limits** button at the top of the PID groups screen.

PCR Jitter Screen

Real time analysis is performed on PCRs and displayed in graphical format. The following options are available:

- PCR Arrival
- PCR Inaccuracy (PCR_AC)
- PCR Overall Jitter (PCR_OJ)
- PCR Drift Rate (PCR_DR)
- PCR Frequency Offset (PCR_FO)
- PTS Arrival

Selecting the **PCR Jitter** button displays a pop-up menu from which the graph type can be selected.

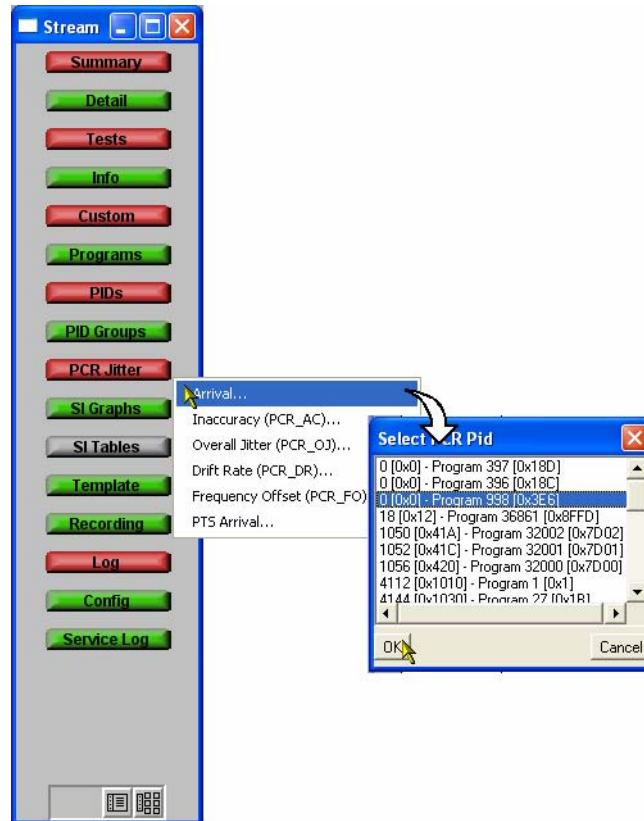

The PCR to be displayed can then be selected in the **Select PCR PID** dialog box. PID numbers are displayed in decimal and hex form.

Common Elements

Statistical information for each graph is shown at the bottom of each graph. When enabled, the **View Limits** checkbox ensures that the parameter limits are shown on the Y-axis. When disabled, the data is allowed to expand to fill the available screen. Limits are set using the parameter function on the Test and PID screens.

PCR Inaccuracy (PCR_AC)

The PCR Inaccuracy graph shows the difference between the actual and expected values for each PCR on the y-axis. Expected PCR values are calculated from the byte index of the PCR and the overall bitrate derived from the PCR.

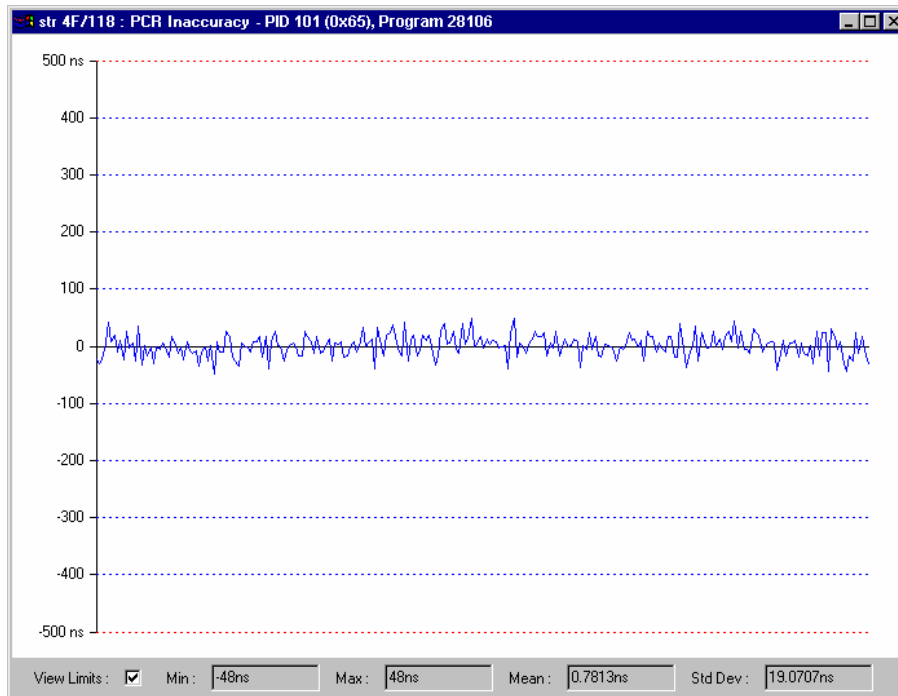

Figure 3-15: Stream view - PCR graph - PCR inaccuracy

The MPEG-2, DVB and ATSC standards specify that PCRs must be within ± 500 ns of the actual transport rate. By default, the scale is set to ± 500 ns. If the Inaccuracy in any of the displayed PIDs is greater than ± 500 ns, the y-axis is drawn to show the complete range of values as full scale.

The Maximum PCR Accuracy Error can be adjusted for all PIDs as follows:

- **Tests screen** → **2.4 PCR Accuracy** parameter (right-click) → **Max PCR accuracy error**.

For individual PIDs:

- **PIDs screen** → **Test**: select **PCR Accuracy** → individual PID parameter (right-click) → **Max PCR accuracy error**.
- Right-click on the graph and set the limit for each PID.

PCR Arrival

The PCR Arrival graph provides a display of the time interval between successive PCRs. The interval is displayed on the y-axis. By default (with the **View Limits** checkbox enabled) the y-axis scale shows the conformance thresholds for the DVB, ATSC or MPEG-2 standards.

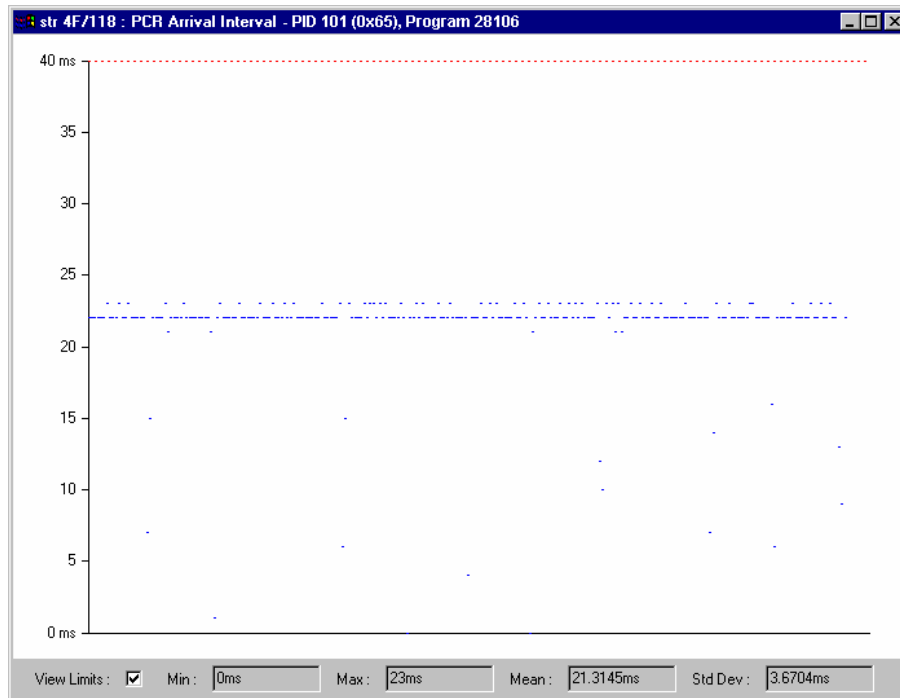

Figure 3-16: Stream view - PCR graph - PCR arrival

The PCR Arrival graph provides a display of the time interval between successive PCRs, during the last 256 PCRs. The interval is displayed on the y-axis. Points are color-coded with respect to the Maximum Repetition Period set in DVB test 2.3 (The DVB default value is 40 ms). Points are plotted in blue when they fall within the specified period. Any points that exceed the interval are plotted in red. If the interval exceeds the limits displayed on the screen, the scale is adjusted automatically as necessary to include the maximum displayed values.

The PCR Maximum Repetition Interval can be adjusted for individual PIDs as follows:

- **PIDs screen** → **Test**: select **PCR Repetition** → individual PID parameter (right-click) → **PCR max repetition interval**.
- Right-click on the graph and set the limit for each PID.

PCR Overall Jitter (PCR_OJ)

The PCR Overall Jitter graph shows the difference between the actual value of the PCR (expressed as a time) and its expected value based on its measured arrival time.

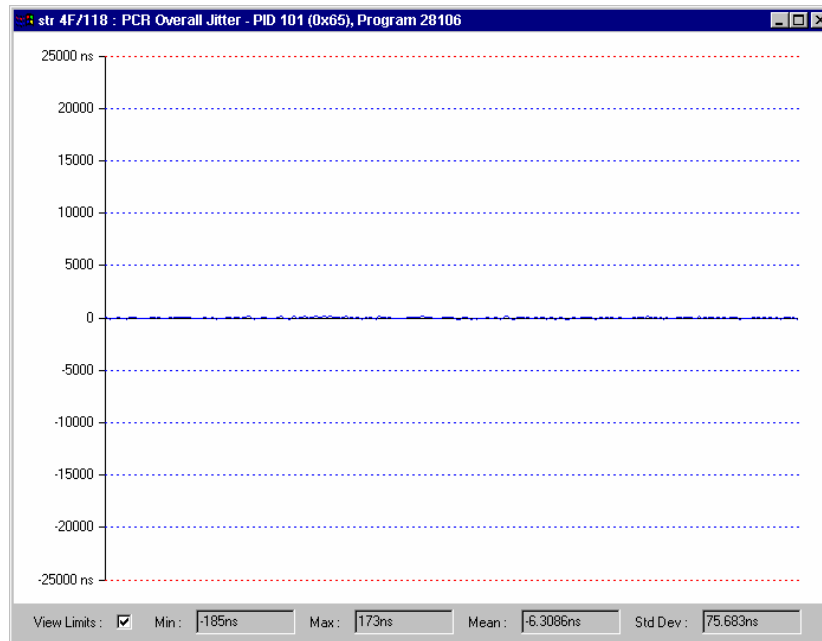

Figure 3-17: Stream view - PCR graph - PCR overall jitter

The Maximum PCR Accuracy Error can be adjusted for all PIDs as follows:

- **Tests screen → PCR Tests section → PCR Overall Jitter (PCR_OJ) parameter (right-click) → Max PCR overall jitter.**

For individual PIDs:

- **PIDs screen → Test: select PCR Jitter → individual PID parameter (right-click) → Max PCR overall jitter.**
- Right-click on the graph and set the limit for each PID.

PCR Frequency Offset (PCR_FO)

The Frequency Offset graph shows the difference between the program clock frequency and the nominal clock frequency (measured against a reference that is not PCR or transport stream derived).

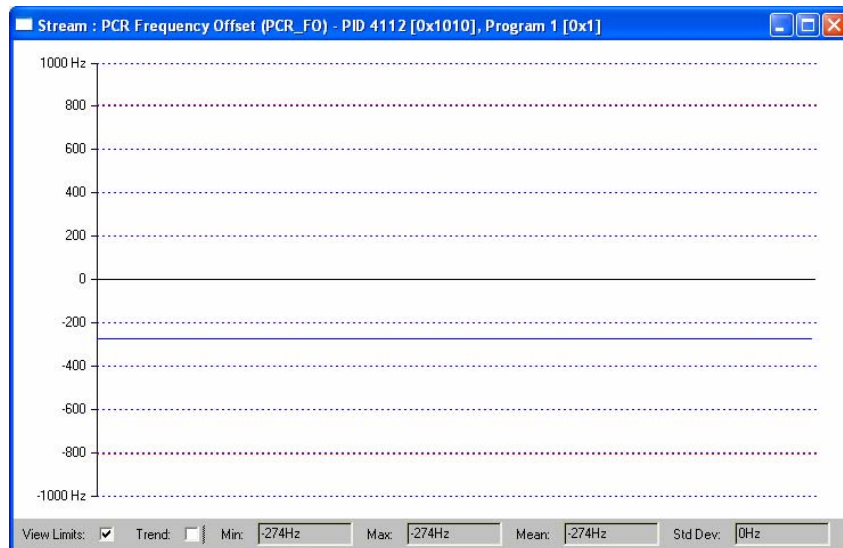

Figure 3-18: Stream view - PCR graph - PCR frequency offset

PCR Frequency Offset is a measurement of the error in the PCR frequency from the specified 27 MHz; the MPEG specification sets the limits at ± 810 Hz.

The Maximum PCR Frequency Offset can be adjusted for all PIDs as follows:

- **Tests screen** → **PCR Tests** section → **PCR Frequency Offset (PCR_FO)** parameter (right-click) → **Max PCR overall jitter**.

For individual PIDs:

- **PIDs screen** → **Test:** select **PCR Offset** → individual PID parameter (right-click) → **Max PCR frequency offset**.
- Right-click on the graph and set the limit for each PID.

PCR Drift Rate (PCR_DR)

This Drift Rate graph shows the rate of change of PCR Frequency Offset, which is often very small. It is calculated using PCR Frequency Offset measurements.

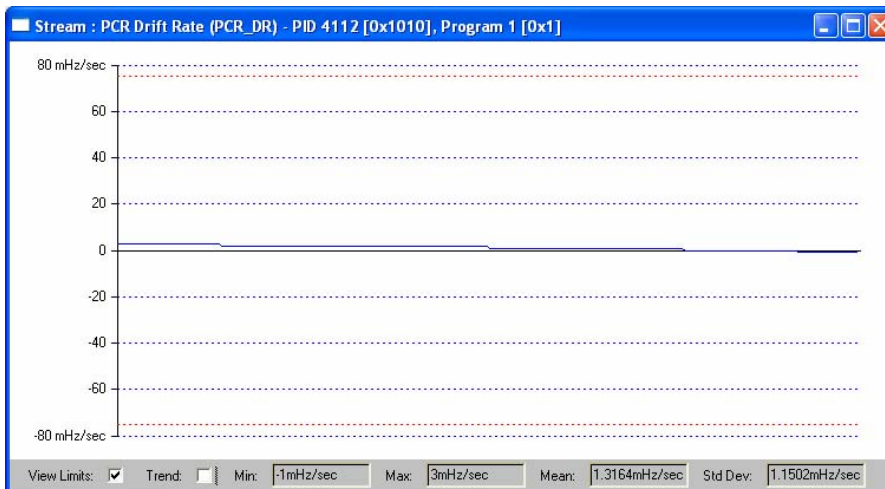

Figure 3-19: Stream view - PCR graph - PCR drift rate

The Maximum PCR Drift Rate can be adjusted for all PIDs as follows:

- **Tests screen → PCR Tests section → PCR Drift Rate (PCR_DR) parameter (right-click) → Max PCR frequency drift rate.**

For individual PIDs:

- **PIDs screen → Test: select PCR Drift Rate → individual PID parameter (right-click) → Max PCR frequency drift rate.**
- **Right-click on the graph and set the limit for each PID.**

PTS Arrival

The PTS Arrival graph shows the time interval between the successive PTSs.

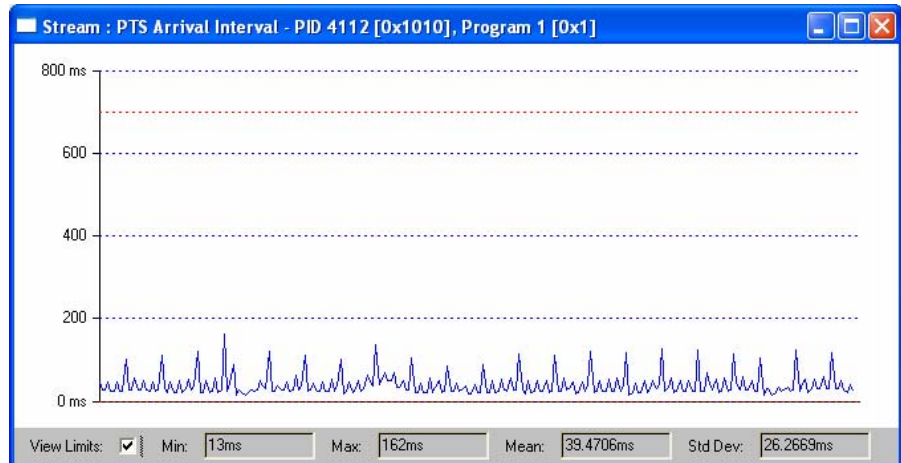

Figure 3-20: Stream view - PCR graph - PTS arrival

The Maximum PTS Repetition Interval can be adjusted for individual PIDs as follows:

- **PIDs screen** → **Test:** select **PTS Repetition** → individual PID parameter (right-click) → **Max PTS repetition interval**.
- Right-click on the graph and set the limit for each PID.

SFN Screen

Where Single Frequency Network (SFN) information is included in a stream, it can be viewed by selecting the SFN button. This action will open an SFN Information screen (see Figure 3-21).

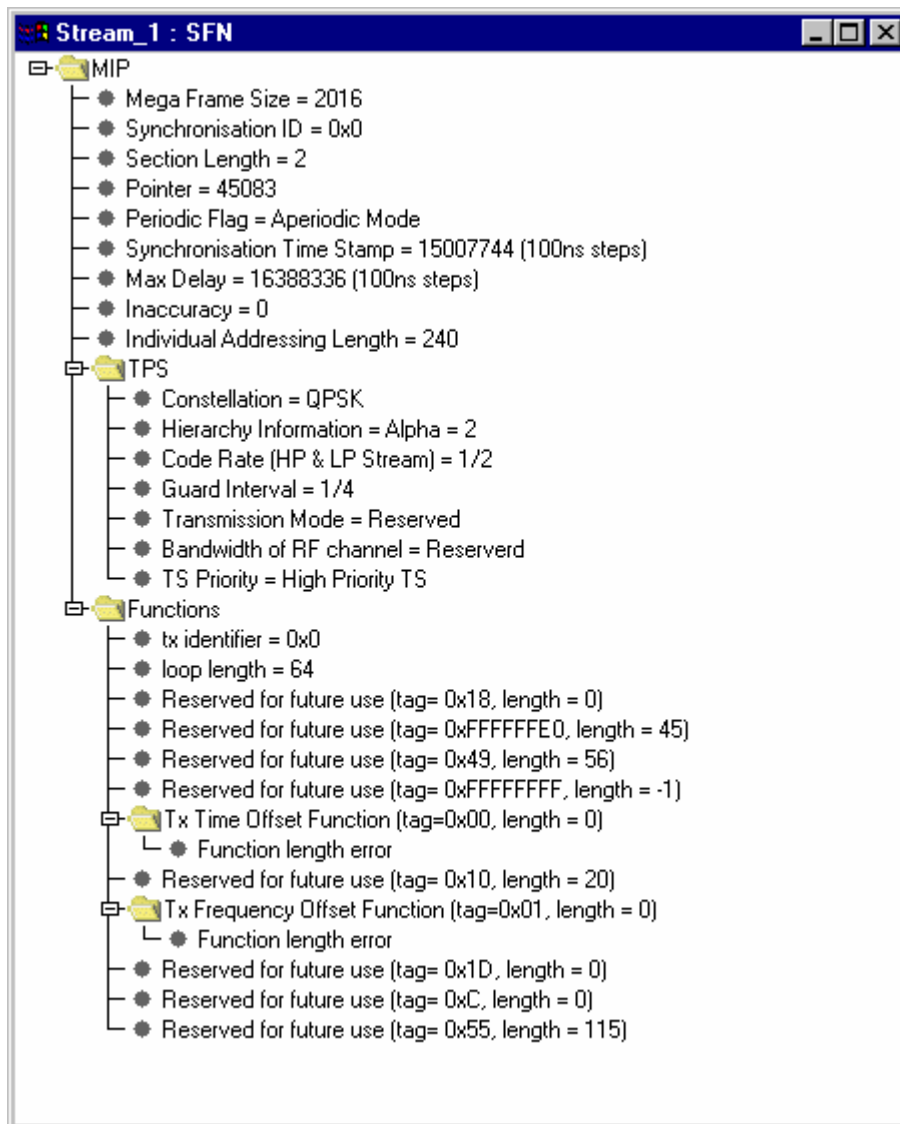

Figure 3-21: Stream view - SFN screen

The screen displays SFN Information when it is transmitted on PID 0x15. The screen displays a snapshot of the Mega Frame Initialization packet in a tree format similar to the SI Tables. The information is updated at regular intervals.

TMCC Screen

This screen shows the Transmission and Multiplexing Configuration Control (TMCC) content of the stream; it is updated in real time. The displayed screen (Satellite or Terrestrial) will depend on which standard is selected for analysis in the *Configuration Screen* (see page 3-76). In ISDB mode, summary IIP information is also shown. Detailed IIP information appears under the SI Tables view, if licensed.

The displayed information is that contained in the TMCC header blocks when that information is present in the transport stream. The information is read-only.

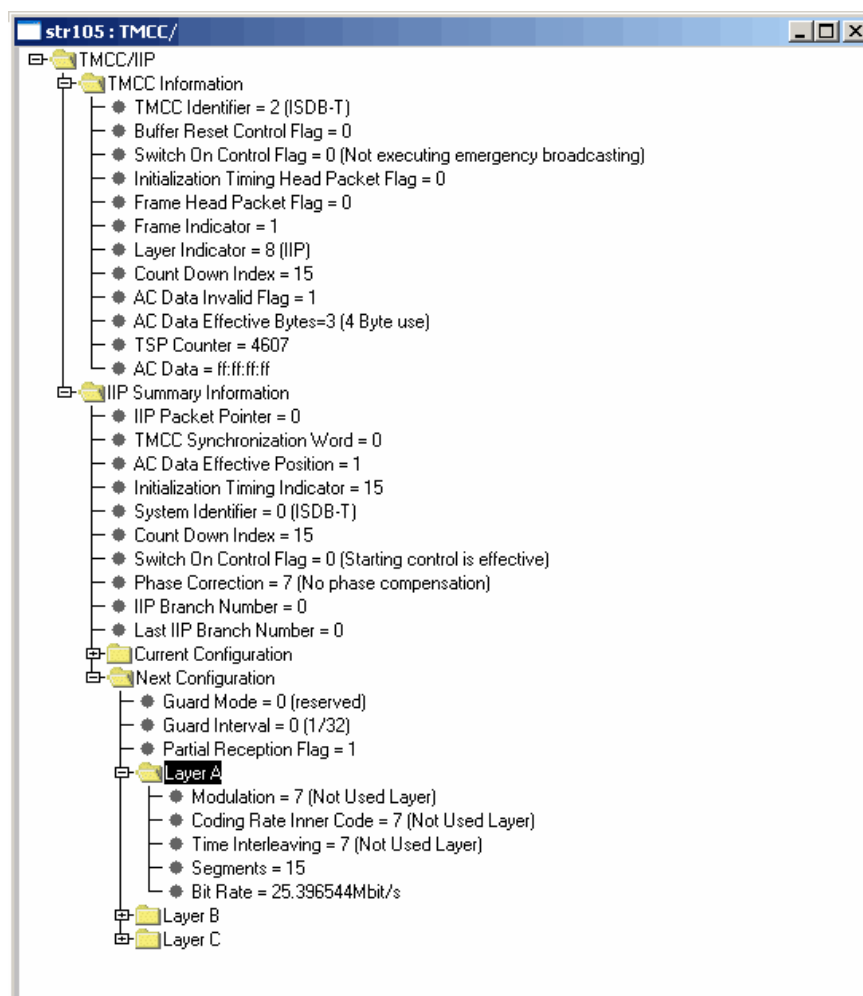

Figure 3-22: Stream view - TMCC screen

The TMCC screen is part of the basic installation; it is not a licensed option. If TMCC data is not present in the stream, the **TMCC** button will not be displayed.

SI Graphs Screen

The SI Graphs screens display information in graphical format about repetition rates of SI tables and subtables.

The following graphs can be displayed:

- Section Repetition Interval
- Subtable Inter Section Gap
- Subtable Repetition Interval
- Cycle Group Repetition Interval

Each graph type can be displayed for a selection of table types. The available graphs vary depending on which standard is selected.

Statistical information for each graph is shown at the bottom of each graph. When enabled, the **View Limits** checkbox ensures that the parameter limits are shown on the Y-axis. When disabled, the data is allowed to expand to fill the available screen. Limits are set using the parameter function on the Test screen and are dependent on the table type.

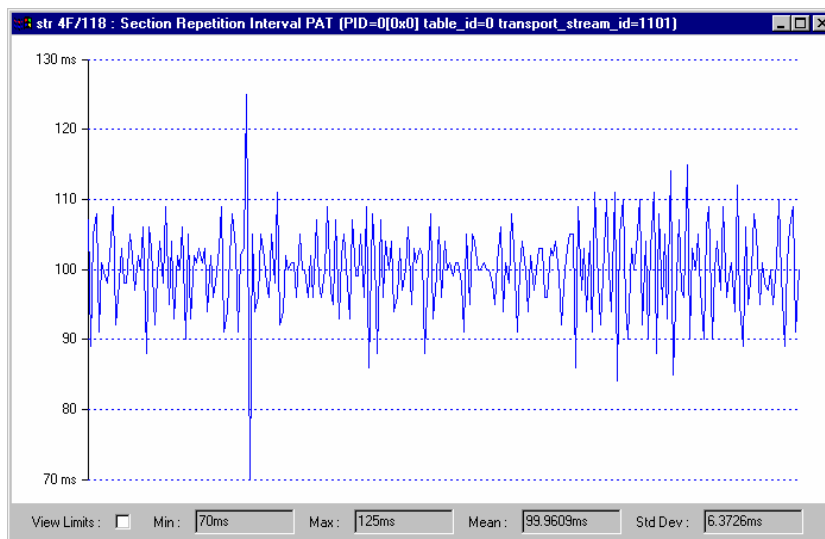

Figure 3-23: Stream view - SI graphs screen - Example

A brief explanation of each graph type follows:

Section Repetition Interval

On a specific PID, this is the interval between the arrival of a section with a specific table_id and the next section with the same table_id.

Subtable Inter Section Gap

This is the interval between the end of one section and the start of the next section in the same subtable. A PID, table_id and table_id extension usually define a subtable, but this varies with table type. (Not available for ATSC.)

Subtable Repetition Interval

This is the repetition rate for complete subtables.

Graph Selection

All graphs are selected in the same way:

1. Select the **SI Graphs** button to display a pop-up menu from which the graph type can be selected.

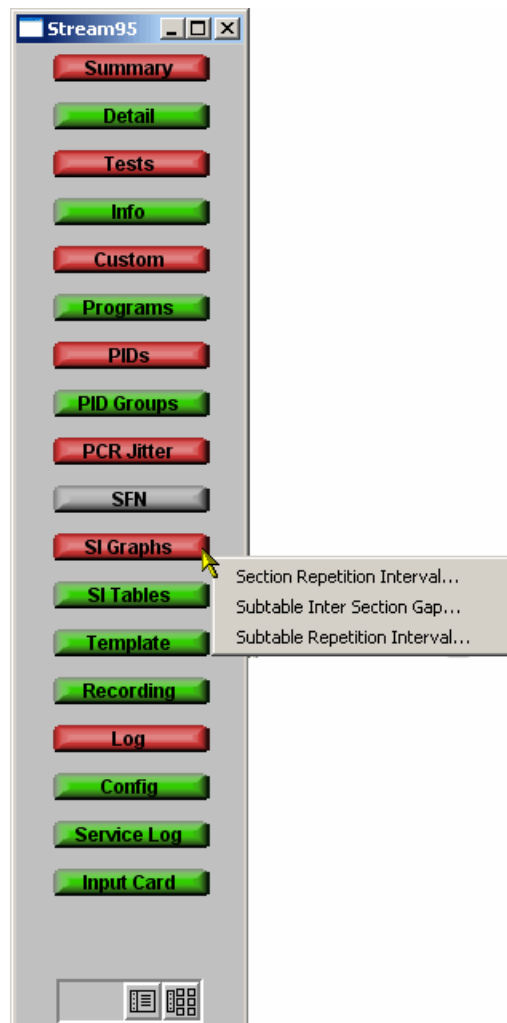

2. In the **Select** dialog, select a table type from the drop-down list.

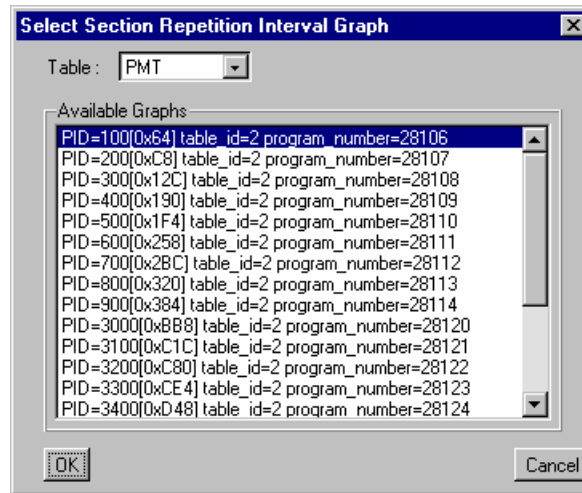

Only those table types for which the graphed information is relevant are available in the list. If the table type is not present in the stream, the message **No Graphs** is displayed.

A list of all PIDs carrying the selected table type is displayed.

3. Highlight the PID required and select **OK**.
4. The associated graph is displayed.

SI Tables Screen

This button displays the SI Tables screen; this shows the transport stream SI/PSI structure. A snapshot of the table structure is built and displayed. The progress bar indicates the progress of the analysis. The analysis can be stopped at any time before completion by selecting **Stop**; only the analyzed elements will be displayed. The structure can be refreshed at any time by selecting the **Update** button. The **Update** button is only enabled when new or changed information is detected in the stream.

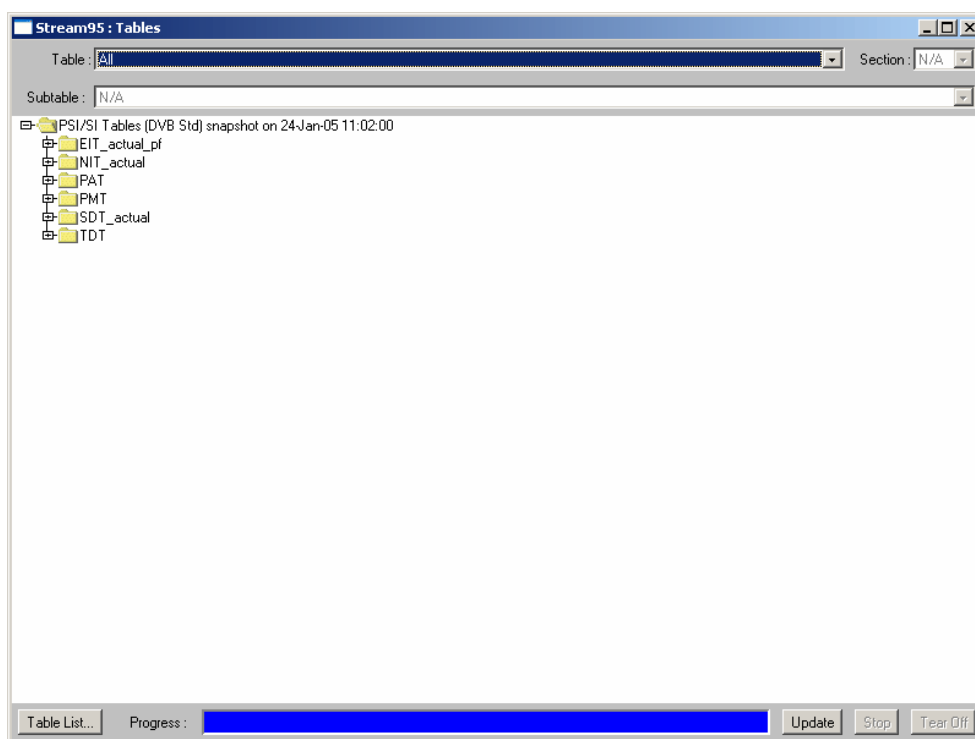

For the DVB/ISDB information, the SI Tables view shows the structure of the Service Information (SI) and Program Specific Information (PSI), including their payload information.

In the DVB version, some of the DVB information displayed will depend on the Regional Setting in the Stream Configuration dialog (see page 3-74), since there are regional variations in the specification of some of the descriptors.

Similarly, for ATSC information, the SI Tables view shows the structure of the Service Information (SI), Program Specific Information (PSIP), including their payload information and the Program Identifier Table (A/57).

The DPI table type may be displayed if the relevant license is displayed.

At Start-up, a set of default tables is displayed in the SI Tables view. The list can be changed and modified by selecting the **Table List...** button and selecting the required Tables.

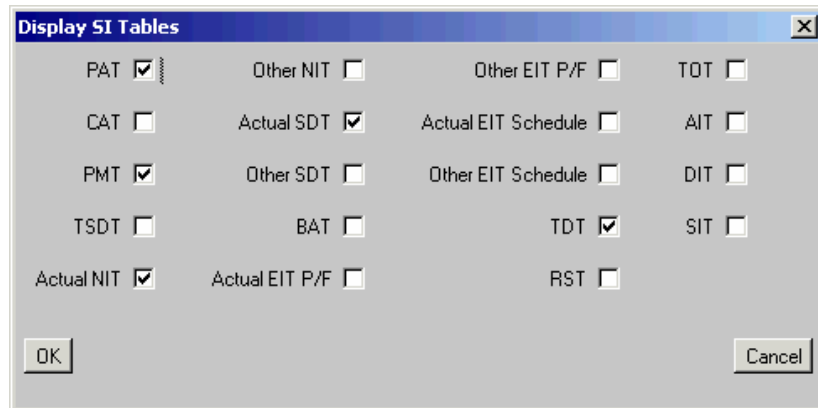

Figure 3-24: DVB SI Tables dialog

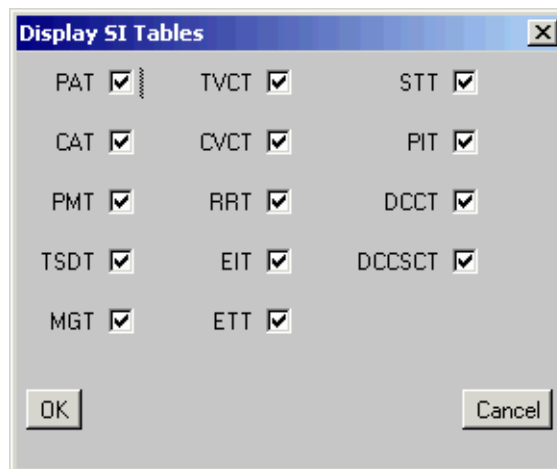

Figure 3-25: ATSC SI Tables dialog

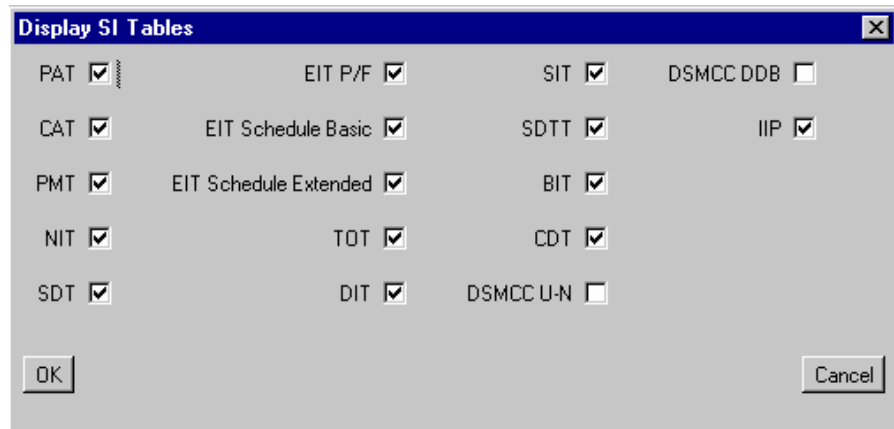

Figure 3-26: ISDB-T SI Tables dialog

The selections do not take effect in the SI Tables view until the view is refreshed using the **Update** button. The speed of the update depends on the network speed, the SI/PSI complexity, and the selected table types.

A tree diagram, with the 'root node' or highest level component at the top is represented in this structure. A square box (or node) indicates components that contain more information beneath them in the structure. If the node has a minus sign in the box, the level of detail below it is already displayed. If the node contains a plus sign, there is another level contained by the node which is currently hidden. The lower levels may be hidden or displayed by clicking on the node.

Components that are connected to a branch of the tree without a square box are leaf nodes. They display the lowest and finest level of detail.

The Table drop-down menu allows you to display all of the SI available in the stream or select a specific table type to be displayed. The drop-down menu lists only those tables found in the stream and enabled in the Table List (see below).

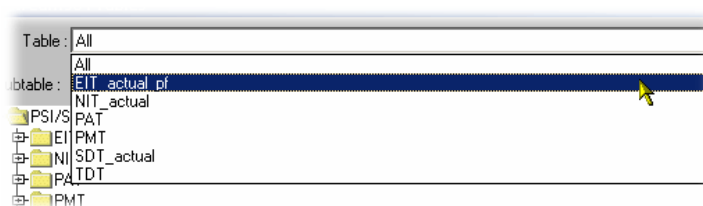

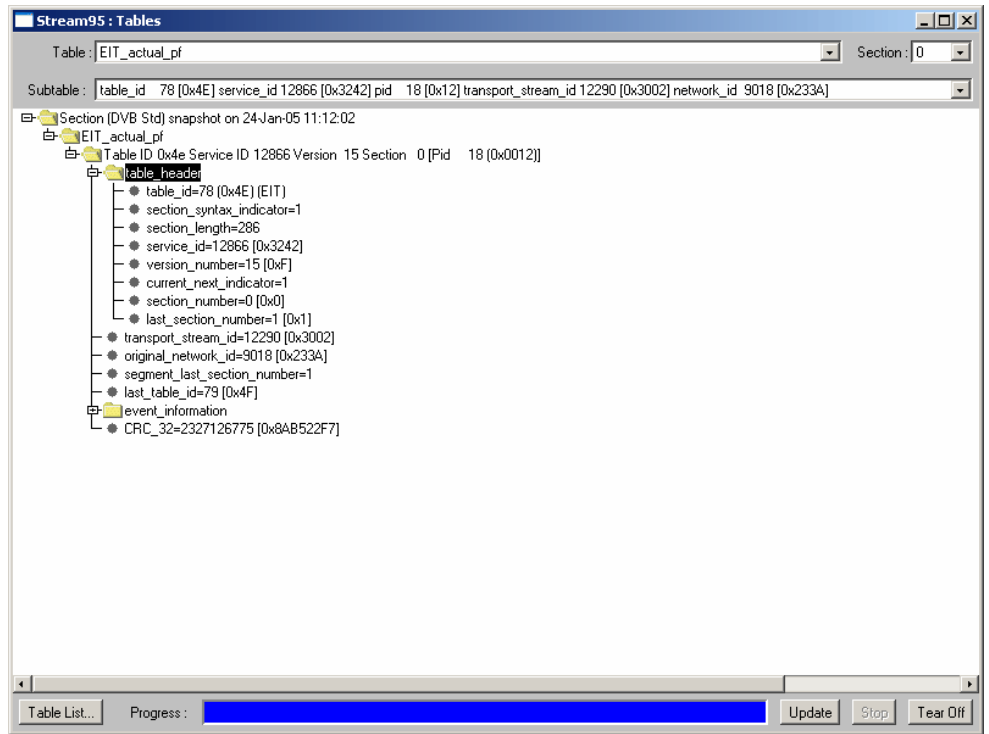

When displaying a selected table type, if the table contains more than one subtable (for example, the EIT_actual_pf), a single subtable is displayed. Other subtables can be selected from the Subtable drop-down menu and displayed.

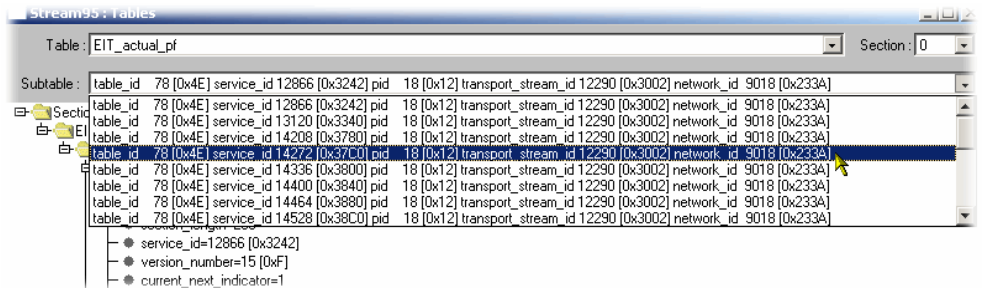

Similarly, when displaying a subtable, if the subtable contains more than one section, a single section can be selected from the Section drop-down menu and displayed.

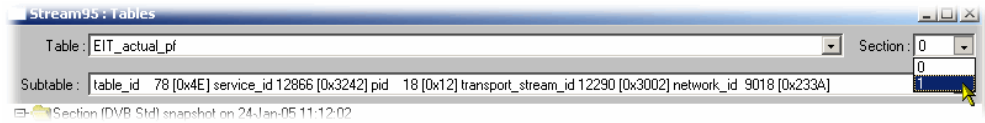

Tear Off View

A useful feature, which allows you to compare sections of the table, is provided using the **Tear Off** button. Selecting this button creates a snapshot of the current tables screen in a separate window. This action can be repeated as many times as required; each press of the button will create a separate window.

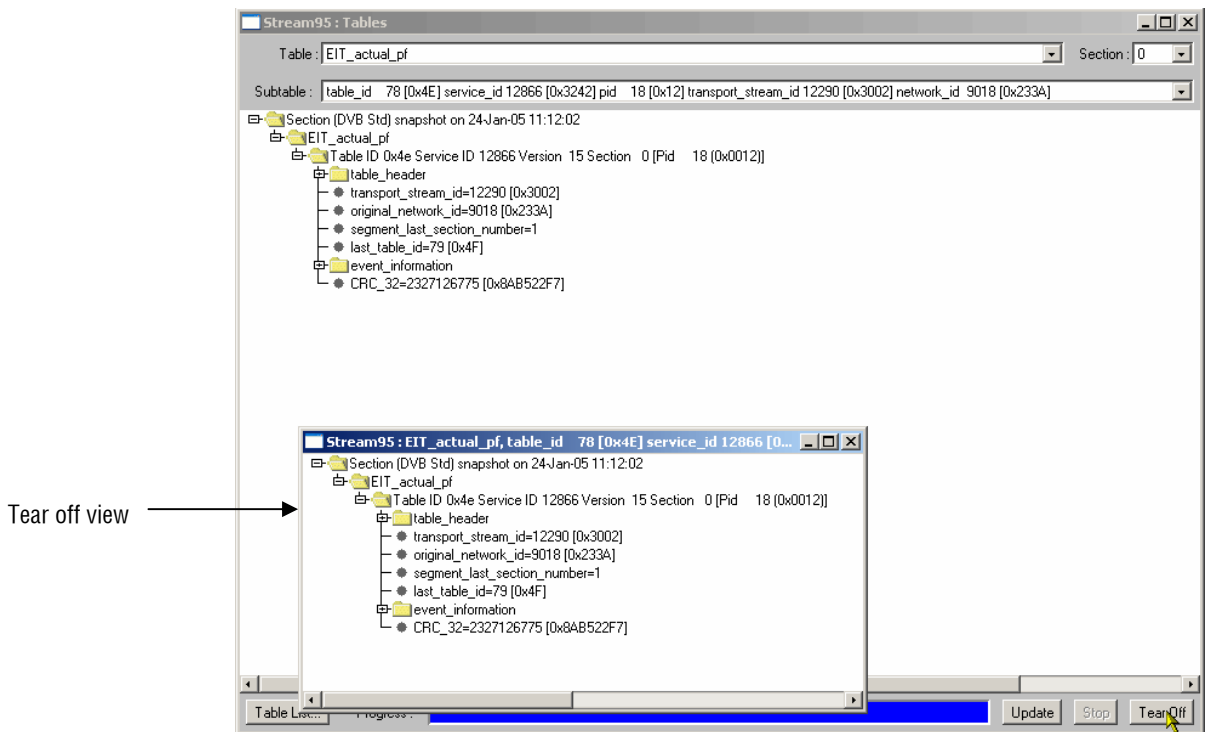
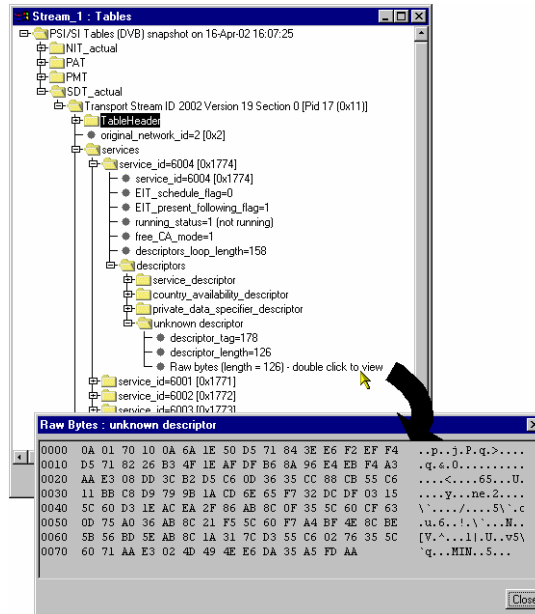

Figure 3-27: SI Tables view - Tear off view

Creation of the table display can be stopped at any time using the Stop button; only the elements analyzed up to that time will be displayed.

Raw Bytes View

Data that cannot be interpreted can be viewed in hex format. Sections that can be viewed in this way will be indicated in the SI Table screen (as shown in the following screen shot).



Severely errored tables, stuffing tables, and tables having non-standard identities are not included in the SI table display.

Template

Simply monitoring the syntax of a Transport Stream according to TR101 290 is not enough to guarantee that the correct information is being delivered to the viewers' receiver. Ensuring that the contents of the Transport Stream are correct requires the monitoring equipment to have prior knowledge of what the broadcaster plans to transmit. A template in which the operator enters the values expected to be present in a Transport Stream can be compared with a transport stream to verify its content, and made to indicate any discrepancy.

The composition of a transport stream may vary during the day as daytime programming is replaced by the evening primetime and then the late night programs. You can schedule template changes to coincide with changes in the program content.

Among the items that can be checked using a template are the following:

- Transport stream identifier
- Services - presence, name
- PIDs in services
- PID types and scrambling state
- Service regional ratings

The template feature allows you to create a template can be applied to a stream (or streams) that is being monitored. If the stream does not conform to the template, the associated icon changes color (in the same way as the error icons) and an entry is made in the error log.

Initially, templates are stream-specific, that is, a template will be created and applied to a specific stream. However, a template can subsequently be uploaded to any device.

In Figure 3-28, the presence of two services (Service 28129 and 28132) in transport stream 1101 is being checked. In addition, details of the service and associated PIDs are checked.

	State	Expected Value	Description
Template			
• TransportStream ID		1101	
• Network ID		32	
• Other Services Allowed		true	
Services			
Service 28129			
• Constraint		Present	
• Service Type		2	
• Service Name		SR 1	
• PCR PID		3901	
• Other PIDs Allowed		true	
PIDs			
PID 1902			
• Constraint		Present	
• Stream Type		5	
Service 28132			
• Constraint		Present	Actual Value = NotPresent
• Service Type		1	
• Service Name		ARD WM2002	
• PCR PID		1101	

Figure 3-28: Stream view - Template

The device and stream identities are shown in the title bar. The template currently in use is shown in the field at the top of the screen.

- The first column shows, in hierarchical and graphical form, the categories of template elements to be applied. Each category can be expanded by clicking on the folder icon (see *Template Manipulation* on page 3-70).
- If the element conforms to the template setting, the **State** icon will be green. Failure to conform is indicated by a red icon. If any elements fail to conform, the Template button will also be red.
- The **Expected Value** is the value provided in the template configuration file.
- A brief **Description** of the reason for failure may be given.

The template content is supplied in XML format as part of the configuration file. The template lists data whose presence and content is to be checked in the transport stream. The State icons indicate that an element listed in the template has conformed to the requirement.

An example of the template section of the configuration file that gave the screen shot shown in Figure 3-28 is given below:

```
<MTM400Configuration Name = "Template Example">
  <Streams>
    <Stream Number="1">
      <PS56>
        <TransportStreamId>1101</TransportStreamId>
        <NetworkId>32</NetworkId>
        <OtherServicesAllowed>1</OtherServicesAllowed>
        <ServiceList Update = "Incremental">
          <Service Number="28132">
            <Constraint>0</Constraint>
            <ServiceType>1</ServiceType>
            <ServiceName>ARD WM2002</ServiceName>
            <PCRPID>1101</PCRPID>
            <OtherPIDsAllowed>1</OtherPIDsAllowed>
            <PIDList Update = "Incremental">
              <PID Number="1102">
                <Constraint>0</Constraint>
                <StreamType>4</StreamType>
              </PID>
            </PIDList>
          </Service>
          <Service Number="28129">
            <Constraint>0</Constraint>
            <ServiceType>2</ServiceType>
            <ServiceName>SR 1</ServiceName>
            <PCRPID>3901</PCRPID>
            <OtherPIDsAllowed>1</OtherPIDsAllowed>
            <PIDList Update = "Incremental">
              <PID Number="1902">
                <Constraint>0</Constraint>
                <StreamType>5</StreamType>
              </PID>
            </PIDList>
          </Service>
        </ServiceList>
      </PS56>
    </Stream>
  </Streams>
</MTM400Configuration>
```

Template Manipulation

The categories of template elements are interpreted in a tree format, the branches of which can be expanded and contracted if the file is viewed in an XML editor or Microsoft Internet Explorer.

Each category title is accompanied by a folder icon. Clicking on a folder will expand that category. Expanding a category may reveal the basic components of the category or it may reveal further sub-categories, which can also be expanded.

A bullet icon is displayed adjacent to basic components. Selecting the folder icon of an expanded category will collapse the category.

XML files can be edited with an XML editor or a text editor (for example, Microsoft Notepad).

Templates and Schedules

The use of templates can be enhanced by scheduling their application and use. In this way a series of templates can be applied chronologically to a stream. *Scheduling* is described on page 3-91.

Recording

See *Triggered Recording*, page 3-99.

Log Screen

An error event log is maintained for the stream being monitored. Each log has a maximum capacity of 10,000 entries; when full, the oldest entries are dropped to make room for new entries.

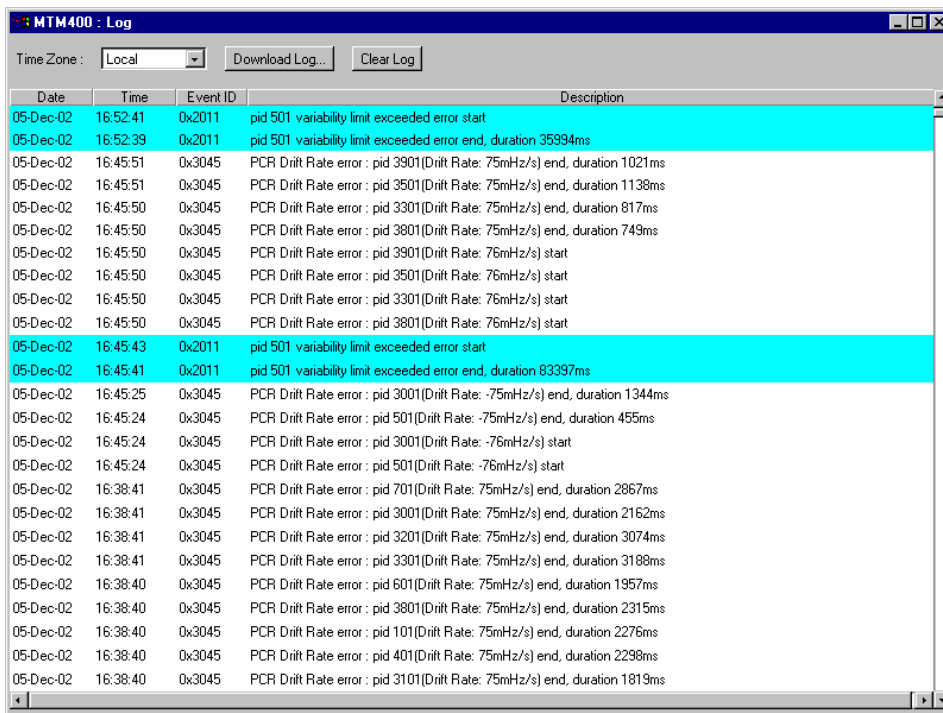

Date	Time	Event ID	Description
05-Dec-02	16:52:41	0x2011	pid 501 variability limit exceeded error start
05-Dec-02	16:52:39	0x2011	pid 501 variability limit exceeded error end, duration 35994ms
05-Dec-02	16:45:51	0x3045	PCR Drift Rate error : pid 3901(Drift Rate: 75mHz/s) end, duration 1021ms
05-Dec-02	16:45:51	0x3045	PCR Drift Rate error : pid 3501(Drift Rate: 75mHz/s) end, duration 1138ms
05-Dec-02	16:45:50	0x3045	PCR Drift Rate error : pid 3301(Drift Rate: 75mHz/s) end, duration 817ms
05-Dec-02	16:45:50	0x3045	PCR Drift Rate error : pid 3801(Drift Rate: 75mHz/s) end, duration 749ms
05-Dec-02	16:45:50	0x3045	PCR Drift Rate error : pid 3901(Drift Rate: 75mHz/s) start
05-Dec-02	16:45:50	0x3045	PCR Drift Rate error : pid 3501(Drift Rate: 75mHz/s) start
05-Dec-02	16:45:50	0x3045	PCR Drift Rate error : pid 3301(Drift Rate: 75mHz/s) start
05-Dec-02	16:45:50	0x3045	PCR Drift Rate error : pid 3801(Drift Rate: 75mHz/s) start
05-Dec-02	16:45:43	0x2011	pid 501 variability limit exceeded error start
05-Dec-02	16:45:41	0x2011	pid 501 variability limit exceeded error end, duration 83397ms
05-Dec-02	16:45:25	0x3045	PCR Drift Rate error : pid 3001(Drift Rate: -75mHz/s) end, duration 1344ms
05-Dec-02	16:45:24	0x3045	PCR Drift Rate error : pid 501(Drift Rate: -75mHz/s) end, duration 455ms
05-Dec-02	16:45:24	0x3045	PCR Drift Rate error : pid 3001(Drift Rate: -75mHz/s) start
05-Dec-02	16:45:24	0x3045	PCR Drift Rate error : pid 501(Drift Rate: -75mHz/s) start
05-Dec-02	16:38:41	0x3045	PCR Drift Rate error : pid 701(Drift Rate: 75mHz/s) end, duration 2867ms
05-Dec-02	16:38:41	0x3045	PCR Drift Rate error : pid 3001(Drift Rate: 75mHz/s) end, duration 2162ms
05-Dec-02	16:38:41	0x3045	PCR Drift Rate error : pid 3201(Drift Rate: 75mHz/s) end, duration 3074ms
05-Dec-02	16:38:41	0x3045	PCR Drift Rate error : pid 3301(Drift Rate: 75mHz/s) end, duration 3188ms
05-Dec-02	16:38:40	0x3045	PCR Drift Rate error : pid 601(Drift Rate: 75mHz/s) end, duration 1957ms
05-Dec-02	16:38:40	0x3045	PCR Drift Rate error : pid 3801(Drift Rate: 75mHz/s) end, duration 2315ms
05-Dec-02	16:38:40	0x3045	PCR Drift Rate error : pid 101(Drift Rate: 75mHz/s) end, duration 2276ms
05-Dec-02	16:38:40	0x3045	PCR Drift Rate error : pid 401(Drift Rate: 75mHz/s) end, duration 2298ms
05-Dec-02	16:38:40	0x3045	PCR Drift Rate error : pid 3101(Drift Rate: 75mHz/s) end, duration 1819ms

Figure 3-29: Stream view - Log

The title bar of the screen identifies the RTM device and the stream currently being monitored.

The **Log** button displays a screen that contains the events logged for the stream in a scrolling list. The list will have the following columns, each with a text heading:

- Date
- Time
- Event ID
- Error Description

The displayed times at which log events occur is the local MTM400 time.

Manipulating the Log Display

When first opened, the most recent events are displayed at the top of the screen; they are scrolled down as new events appear. Using the **Home** key on the keyboard displays the most recent events; similarly the **End** key will display the oldest events; in both cases events will continue to scroll. If a single event is to be viewed, selecting the **PageDown** key will scroll and freeze the display. However, since events continue to be recorded, the event will eventually reach the bottom of the log and be lost; how quickly this happens will depend on the number and speed of events being displayed.

Log entry Highlights

A popup menu is available by right-clicking anywhere within the listing.

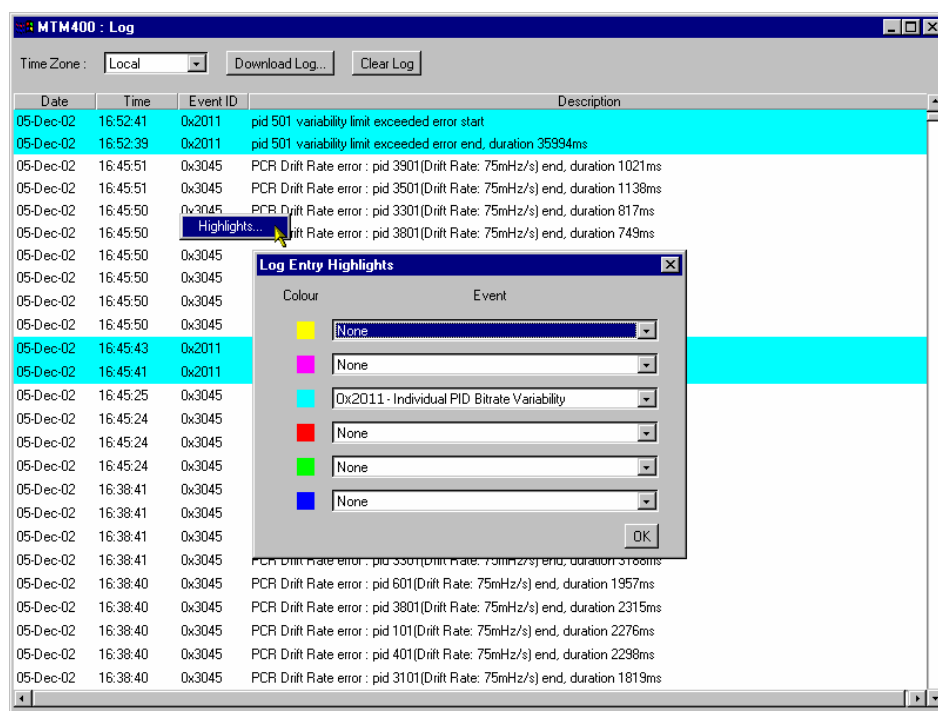

Using the Log Entry Highlights dialog allows specific types of entry to be highlighted in a selected color. Select the **Event** type (Event ID) to be highlighted from the drop-down list adjacent to the **Color** required. Select OK to close the dialog and implement the highlighting.

Saving the Stream Log

The Stream Log can be saved using the **Download Log...** button. In the **Log Download** dialog, select (or enter) a filename and path and select the **Start** button. Select the **Close** button when the operation has finished or to terminate the process early.

The resulting downloaded log file is saved in CSV (comma separated values) format.

Clearing the Stream Log

Select **Clear Log** to clear the current log entries.

Multiple Entries

Sometimes, errors of a specific type are generated many times. To avoid reporting excessive error entries (which could make the error log difficult to read), each time a new error is detected, the word **start** is added to the error message in the Log screen. No more occurrences of the same error are reported until the test is passed. At that point, a message will be displayed on the Log screen giving the error Event ID, and appending the word **end** to the message; the duration (ms) between the start (event fail) and end (event pass) message is also given.

Date	Time	Event ID	Description
08-Aug-02	08:54:12	0x3028	ETR 290 error 2.4 (PCR_accuracy_error) : pid 3501(Inaccuracy: -23ns) end, duration 52ms
08-Aug-02	08:54:12	0x3028	ETR 290 error 2.4 (PCR_accuracy_error) (pid 701)Inaccuracy: 141ns) start
08-Aug-02	08:54:12	0x3028	ETR 290 error 2.4 (PCR_accuracy_error) : pid 3201(Inaccuracy: 125ns) start
08-Aug-02	08:54:12	0x3028	ETR 290 error 2.4 (PCR_accuracy_error) : pid 301(Inaccuracy: -90ns) end, duration 114ms
08-Aug-02	08:54:12	0x3028	ETR 290 error 2.4 (PCR_accuracy_error) (pid 401)Inaccuracy: 122ns) start
08-Aug-02	08:54:12	0x3028	ETR 290 error 2.4 (PCR_accuracy_error) : pid 3901(Inaccuracy: -39ns) end, duration 29ms
08-Aug-02	08:54:12	0x3028	ETR 290 error 2.4 (PCR_accuracy_error) : pid 3201(Inaccuracy: -92ns) end, duration 93ms
08-Aug-02	08:54:12	0x3028	ETR 290 error 2.4 (PCR_accuracy_error) : pid 3101(Inaccuracy: 166ns) start
08-Aug-02	08:54:12	0x3028	ETR 290 error 2.4 (PCR_accuracy_error) (pid 701)Inaccuracy: -99ns) end, duration 23ms
08-Aug-02	08:54:12	0x3028	ETR 290 error 2.4 (PCR_accuracy_error) : pid 801(Inaccuracy: -101ns) start
08-Aug-02	08:54:12	0x3028	ETR 290 error 2.4 (PCR_accuracy_error) : pid 3001(Inaccuracy: -57ns) end, duration 22ms
08-Aug-02	08:54:12	0x3028	ETR 290 error 2.4 (PCR_accuracy_error) : pid 3701(Inaccuracy: -94ns) end, duration 23ms
08-Aug-02	08:54:12	0x3028	ETR 290 error 2.4 (PCR_accuracy_error) (pid 401)Inaccuracy: 92ns) end, duration 23ms
08-Aug-02	08:54:12	0x3028	ETR 290 error 2.4 (PCR_accuracy_error) : pid 3801(Inaccuracy: -39ns) end, duration 23ms

Time Zone

The displayed times at which log events occurred can be adjusted by making a selection from the **Time Zone** drop-down list at the top of the window. The following options are available:

Local The time local to the machine on which MTM400 Remote User Interface is currently running.

UTC Universal Coordinated Time.

RTM Device The time local to the RTM device being monitored.

(For a general description of the timing model, see *Time Zones*, page 2-13.)

Configuration Screen

The Stream Configuration screen which allows the user to configure various stream settings, triggered recording, and scheduling. The configuration settings available for DVB, ATSC and ISDB differ; each screen is shown below. The fields displayed are also dependent on the options enabled. The following descriptions describe all settings.

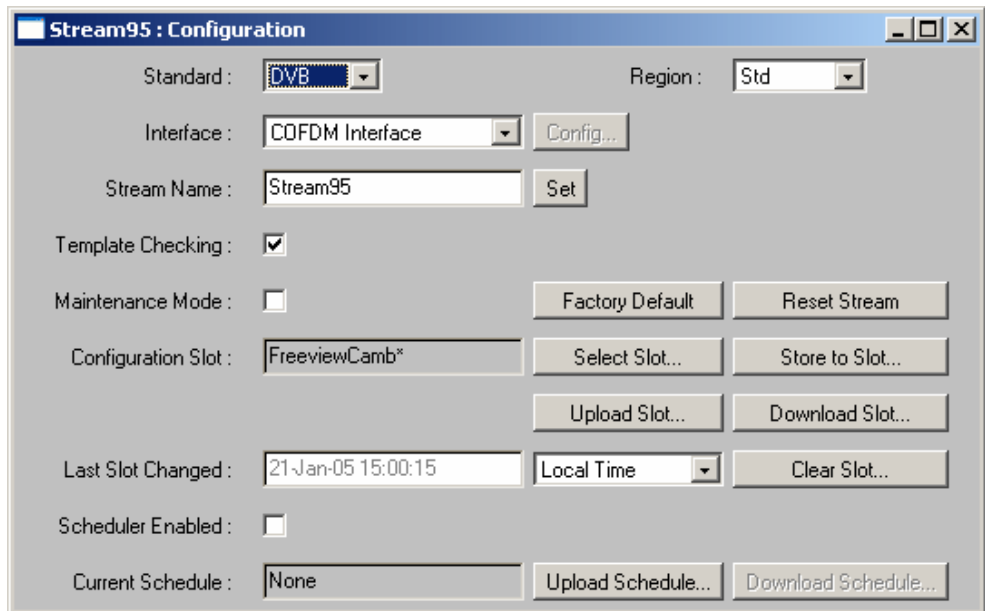

Figure 3-30: Stream view - Configuration (MTM400 DVB format)

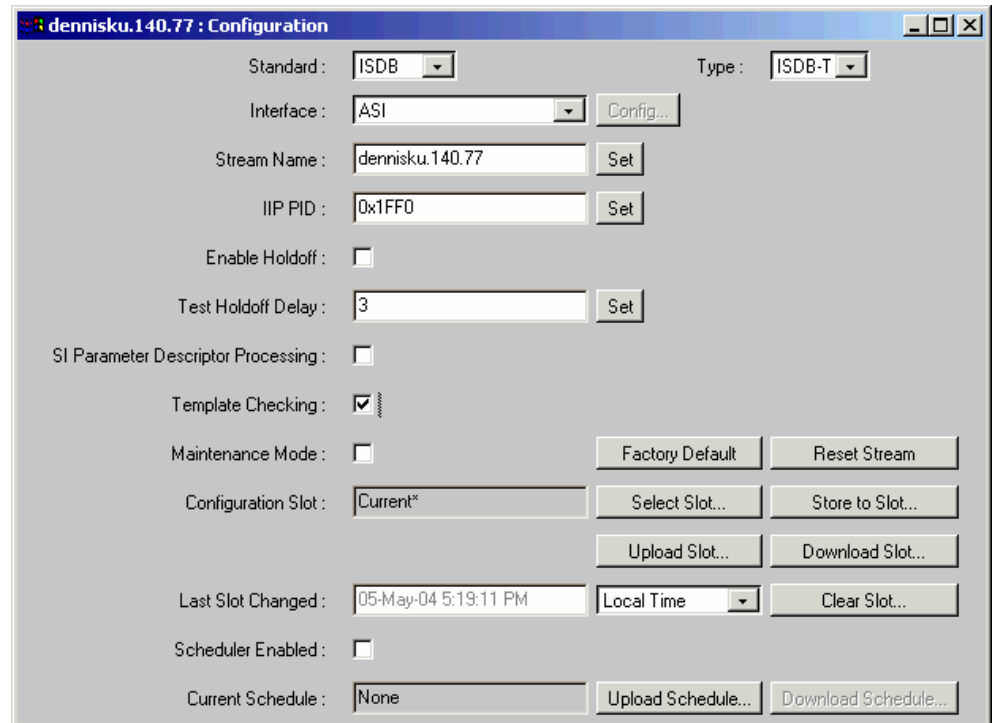

Figure 3-31: Stream view - Configuration (MTM400 ISDB format)

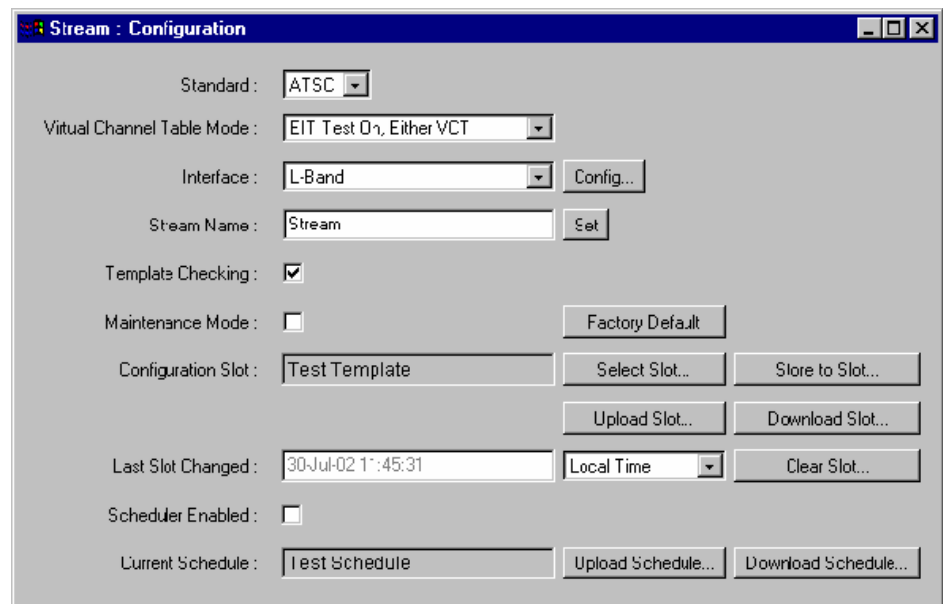

Figure 3-32: Stream view - Configuration (MTM400 ATSC format)

Standard Shows the MPEG broadcast standard selected for stream analysis: **DVB**, **ATSC**, **ISDB** or **Chinese**.

Region / Type This selection dictates the way in which regional variations in SI Tables view are interpreted. The available options are:

Table 3-2: DVB Regional Options

DVB Region	Description
Std	Default setting uses standard DVB interpretation of descriptors.
DTG	DVB + DTG interpretations.
Nordig	DVB + Nordic interpretations.
Reserved	(Not Used.)
Aus	DVB + Australian interpretations.

No regional variants are available for the **ATSC** standard.

Table 3-3: ISDB Regional Options

ISDB Region	Description
ISDB-S	(default) Satellite setting.
ISDB-T	Terrestrial setting.
1 Segment	Partial reception (limited bandwidth devices)

Table 3-4: Chinese Regional Options

Chinese Region	Description
GY/Z 174-2001	DVB + GB2312 encoding.
GB2312	DVB + implied GB2312.

Changing either the **Standard** or the **Region/Type** restarts the MTM400 unit. A warning message, requiring confirmation, is displayed.

Virtual Channel Table Mode

(ATSC only) A drop-down list from which the Virtual Channel Table Mode can be selected. The options available are shown below:

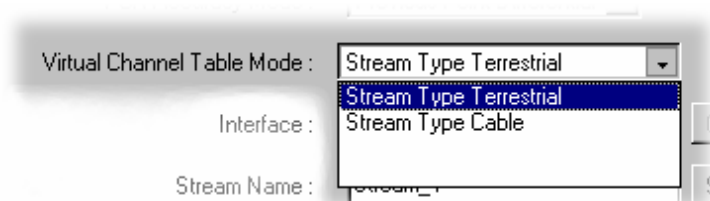
**Interface**

A drop-down list from which the interface to be used for the stream is selected. The interfaces available, such as SMPTE, ASI and QPSK (L-Band), will depend upon the RTM device.

Config... Opens the configuration dialog for the selected interface.
(See page 3-107.)

Stream Name

Allows you to assign a name to the stream. The name set will appear wherever the stream name is displayed, for example, in the title bar of all screens.

Enter the required name and select the **Set** button.

If you do not set a name, the default name, Stream, is used.

IIP PID

(ISDB only) Allows you to specify the packet number of the ISDB-T Information Packet.

The IIP PID value is predefined; to change it, enter the required value and select the **Set** button.

Enable Holdoff and Test Holdoff Delay

(ISDB only) Enables and sets how long after a PAT/PMT SI version change all tests are disabled.

SI Parameter Descriptor Processing

(ISDB Only) The MTM400 can process SI repetition rates tests against user definable parameters, or by taking dynamic test limits from the broadcast SI when available.

Template Checking*

When enabled, applies the current template to the stream.

Maintenance Mode

When enabled, no alarms (TTL, relays or audible) will be raised for the stream. The RTM device will continue to monitor the stream and errors will be logged. The action of enabling and disabling maintenance mode is also recorded in the log. In this mode, all buttons are colored black.

Reset Stream

This button returns the MTM400 to the initial state upon acquiring a stream; all tests are reset and all SI information is flushed. This is useful if you make a seamless switch between nearly identical streams, if there is no change in the SI identity and/or versions to inform the MTM400 that is a new stream, you can reset the stream manually here.

Configuration Slot

See *MTM400 Configuration Files*, page 3-85.

Scheduling*

See *Scheduling*, page 3-91.

Buttons

Factory Default

When selected, all stream configuration items for the current stream are reset to their factory defaults.

* - licensed options (see *Table 1-5: MTM400 options summary*, page 1-6).

Service Log

Each program in a transport stream can contain one or more elementary streams (for example, video, audio and control). The content of each elementary stream is carried as packets of data; each elementary stream is assigned a Packet Identifier (PID). Service Logging allows packet counts for specified PIDs (range: 0 to 100) to be collected at a user-definable interval.

Typically this information can be used by network operators to bill customers for transferred data. Network operators may want to present an itemized bill for packets of data carried in each time period.

The data is stored as a grid. After each time period, all the counts move down one position and a new count is started in the top row. The grid is 64 rows (time periods) deep and 100 PIDs wide. So up to 100 PIDs may be monitored, with a common timing resolution.

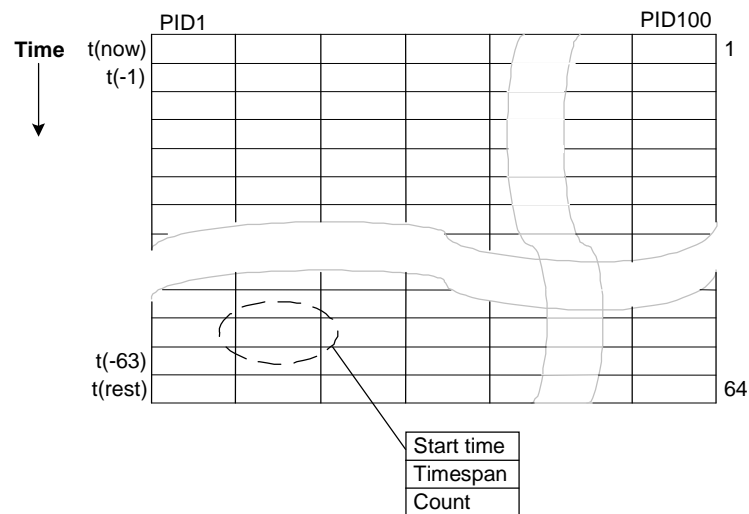

Figure 3-33: Service logging - Data storage

The timing resolution should not be set too fast or data may reach the bottom of the grid ($t(\text{rest})$) before it can be read. If data does reach the bottom of the grid, it is not lost but it is accumulated in the final row. Accumulated data is added to the bottom row for up to three days. After this time the data is discarded and the PID is no longer monitored.

When a service log is being monitored from multiple locations, only one location should be selected to consume entries. This will allow all locations adequate time to view or log the entries.

The customer must balance the level of detail required (the timing resolution) with the infrastructure that is required to collect, store, and collate the information. Typically the timing resolution is set for 1000 ms; in this case the grid cell will contain a value approximating to 'packets per second'; to improve accuracy each count has an associated duration.

The screenshot shows the 'Stream : Service Log' window. At the top, there are several settings: 'Consume Entries' (unchecked), 'Log Entries' (unchecked), 'Packet Counting Bin Duration (PS4)' (100ms), 'Log Filename' (empty), 'Number of Packet Counting Bins (PS6)' (2), 'Max List Entries' (100), and 'Timing Interval (PS4 * PS6 * 10)' (2000ms). Below these settings is a table with the following columns: Time, Duration, PID 4176, PID 4178, PID 4180, PID 4182, PID 4184, and PID 4186. The table contains 20 rows of data, each representing a log entry with its timestamp, duration, and PID values.

Time	Duration	PID 4176	PID 4178	PID 4180	PID 4182	PID 4184	PID 4186
15/07/03 08:15:11	2.002	7903	0	0	0	0	0
15/07/03 08:15:08	2.998	11968	0	0	0	0	0
15/07/03 08:15:06	2.002	7882	0	0	0	0	0
15/07/03 08:15:03	2.999	11971	0	0	0	0	0
15/07/03 08:15:00	2.999	11894	0	0	0	0	0
15/07/03 08:14:58	2.001	7924	0	0	0	0	0
15/07/03 08:14:55	2.999	11931	0	0	0	0	0
15/07/03 08:14:53	2.003	7921	0	0	0	0	0
15/07/03 08:14:51	1.998	7965	0	0	0	0	0
15/07/03 08:14:49	2.000	7953	0	0	0	0	0
15/07/03 08:14:47	2.003	7974	0	0	0	0	0
15/07/03 08:14:44	2.999	11970	0	0	0	0	0
15/07/03 08:14:42	2.002	7901	0	0	0	0	0
15/07/03 08:14:40	1.998	7981	0	0	0	0	0
15/07/03 08:14:38	2.002	7980	0	0	0	0	0
15/07/03 08:14:36	1.999	7915	0	0	0	0	0
15/07/03 08:14:34	2.002	7980	0	0	0	0	0
15/07/03 08:14:31	2.999	11915	0	0	0	0	0
15/07/03 08:14:29	2.001	7950	0	0	0	0	0
15/07/03 08:14:26	3.000	11951	0	0	0	0	0
15/07/03 08:14:23	2.999	11875	0	0	0	0	0
15/07/03 08:14:21	2.001	7981	0	0	0	0	0

Figure 3-34: Stream view - Summary

The following settings are available:

- Consume Entries** The data in the service log is not discarded once it is read; this means that more than one RUI may view the data. One RUI should be nominated to consume the entries. This RUI will then be guaranteed to get all of the data without another RUI consuming the data. Where the data is logged to disk, the logging RUI must be the consuming RUI.
- Log Entries** Select this checkbox if entries are to be logged to a file.
- Log Filename** Displays the log file name.
A log file name can only be set when the **Consume Entries** checkbox is selected.
The log file is written in CSV (comma separated values) format. In this format, it can be transferred to any suitable analysis program, for example, Microsoft Excel.
- Max. List Entries** This value sets the number of entries that are displayed. It does not affect the actual logging of counts.
Enter a value in the field and select **Set**.
- PIDs button** Select this button to display the Service PIDs dialog that lists the PIDs currently being logged. The dialog also allows PIDs to be added and deleted.

The timing resolution of counts is controlled by configuration file parameter PS4 (**Packet Counting Bin Duration**) multiplied by PS6 (**Number of Packet Counting Bins**), typically PS4 * PS6 is set for 1000 ms.

PS4 is the τ (tau) value for the PID occupancy bit rate measurement as defined in TR 101 290. This value affects many measurements; in this case it ensures that the timespan is a whole multiple of the bit rate counting interval and reduces sampling errors. PS6 should be set to give the required count duration - **Timing Interval (PS4 * PS6 * 10)**.

Service Log Configuration

The Service Log parameters can also be set using the configuration file.

The example below shows how to monitor four PIDs. Note that the PIDs may be specified as separate elements or as a space delimited list.

```
<?xml version="1.0" encoding="UTF-8"?>
<MTM400Configuration Name="Service Log Config"
  xmlns:xsi="XMLSchema-instance"
  xsi:noNamespaceSchemaLocation="config.xsd">
  <Streams>
    <Stream Number="1">
      <PS6>10</PS6>
      <PS4>100</PS4>
      <ServiceLog>
        <PIDS>301</PIDS>
        <PIDS>302</PIDS>
        <PIDS>304 410</PIDS>
      </ServiceLog>
    </Stream>
  </Streams>
</MTM400Configuration>
```

This configuration can be embedded in a full configuration file, or just uploaded as an incremental change (refer to *Configuration File Structure* in the *MTM400 MPEG Transport Stream Monitor Programmer Manual*).

MTM400 Configuration Files

Configuration files provide a means of supplying and storing all stream-related, user-definable parameters active in an RTM device. Configuration files may be complete, containing all parameters, or partial, containing only those parameters that require changing. The files are composed in XML (Extensible Markup Language) format and can contain sections relating to all aspects of configuration; template information can also be included. The files can be viewed in Internet Explorer or they can be viewed and edited in a text editor, for example, Microsoft Notepad. (See also *Configuration File Structure* in the *MTM400 MPEG Transport Stream Monitor Programmer Manual*.)

The concept of configuration files allows uniformity in setup to be achieved at a range of locations (RTM devices), especially where scheduling is supported. An additional facility allows weekly schedules to be written for each stream, which instructs the MTM400 to load configuration slots at specific times and days during the week (see *Scheduling*, page 3-91).

In MTM400, configuration settings are held in 'storage slots'; eight storage slots are available for each stream. The contents of a storage slot must be applied to the 'active' area (active configuration) before it is implemented.

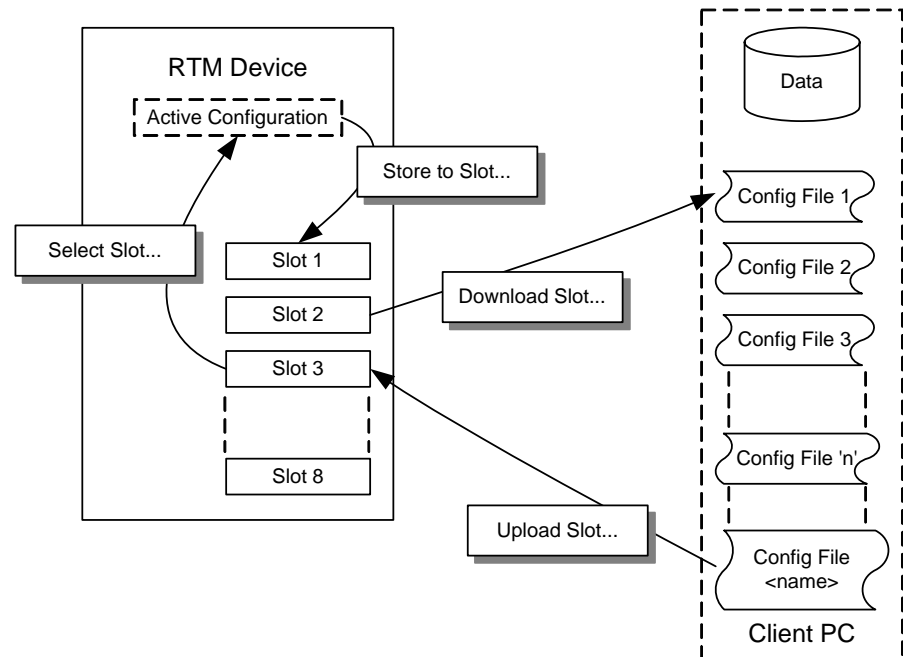

Figure 3-35: Configuration file handling

You can modify the active parameters during normal operation; these changes will only affect the active configuration. The active configuration is saved in non-volatile RAM as operational changes are made and will be recovered after the unit is reset or powered off.

The active configuration settings can also be saved to any of the storage slots. The contents of a storage slot can subsequently be downloaded to a file on a remote, networked PC. Similarly, a correctly configured file (or portion of a file) can be uploaded into any slot; where a 'portion of a file' can be a correctly configured XML file which specifies a subset of the total configuration file.

The default names allotted to the slots are **Slot 1 to Slot 8**; they are always displayed in the same order. When a configuration file occupies the slot, the name is changed to that of the configuration file; however, the position of the slot in the list remains the same.

Activating a Slot

For the settings stored in a slot to become active, the contents of a storage slot must be transferred to the active configuration.

1. From the Configuration view, select **Select Slot...**

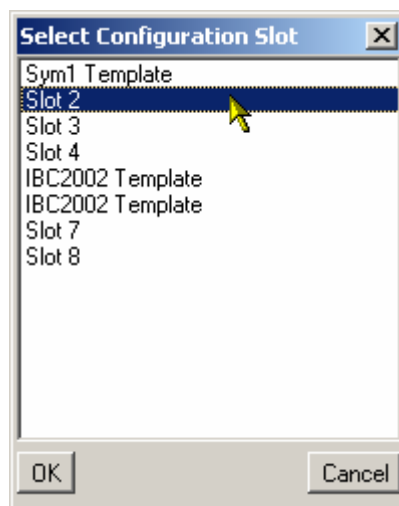

2. From the list, select the required slot.
3. Select **OK**.

The settings stored in the selected slot will be copied to the active configuration.

Storing Active Settings to a Slot

The settings currently held in the active configuration can be copied to any storage slot.

1. From the Configuration view, select **Store to Slot...**

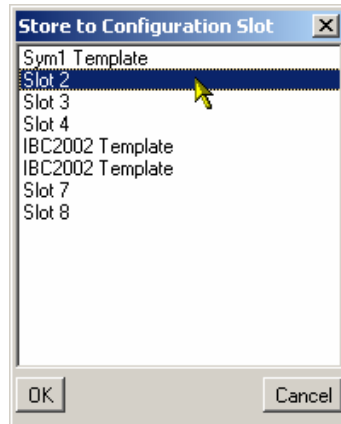

2. From the list, select the required slot.
3. Select **OK**.

The active configuration settings will be stored in the selected slot.

Downloading from a Storage Slot

The settings currently held in a storage slot can be copied to a file, for example, for modification.

1. From the Configuration view, select **Download Slot...**

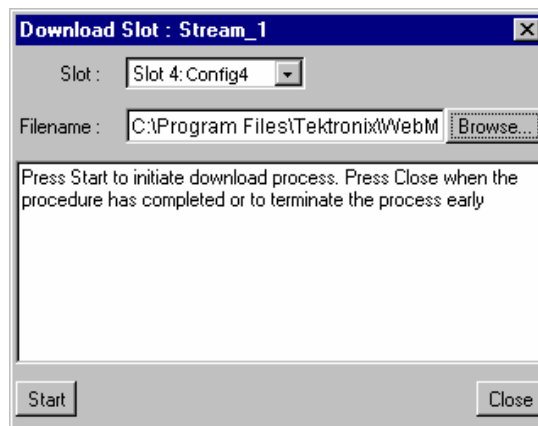

2. From the **Slot:** drop-down list, select the required slot.

3. Locate and select the configuration file or type in a new name; use the **Browse...** button if necessary.
4. Select **Start** to download the configuration setting from the selected slot.

Uploading to a Slot

Correctly prepared configuration files can be uploaded to a slot.

1. From the Configuration view, select **Upload Slot....**

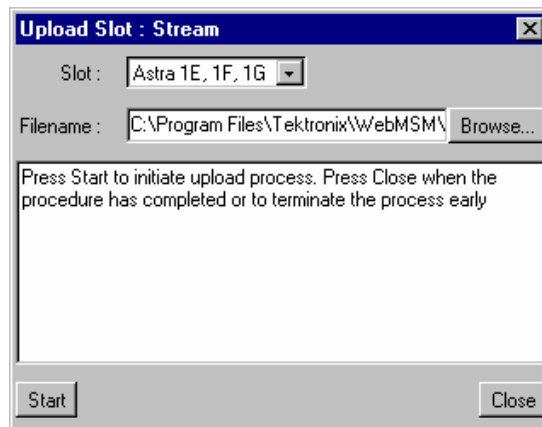

2. From the **Slot:** drop-down list, select the required slot.
3. Locate and select the configuration file to be uploaded or type in the path and name (*.xml); use the **Browse...** button if necessary.
4. Select **Start** to upload the configuration setting into the selected slot.

If the file is incorrectly formatted, the operation will fail and a message will be displayed in the dialog box.

Clearing a Slot

Slots can be cleared as follows:

1. From the Configuration view, select **Clear Slot....**

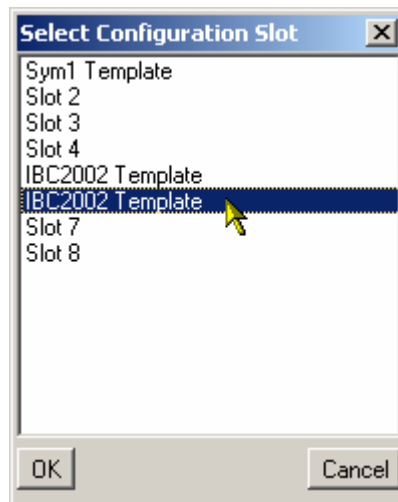

2. From the list, highlight the slot to be deleted.
3. Select **OK**.

The slot name is deleted from the dialog and replaced with the slot number.

4. Select **Start** to upload the configuration setting into the selected slot.

Scheduling

Configuration schedules allow information held in configuration slots (see page 3-80) to be activated at specified times and days of the week. Schedules operate on a weekly basis.

A schedule includes the following information:

- A schedule name. When the schedule is uploaded to the RTM device, the schedule name will be displayed in the **Current Schedule** field in the **Configuration** dialog.
- UTC Offset (see *Scheduling and Time Zones*, page 3-96).

The schedule file can be uploaded to RTM devices in many time zones, ensuring that the configuration files will be activated at the same moment on each device.

It will then contain a number of schedule items, each specifying the following details:

- Configuration Slot - the number of the stored slot (1 to 8) to copy to the 'active' slot
- Load Time - time configuration slot should be copied in the specified schedule time zone (HH:MM:SS)
- The days of the week when this is to be applied, This can be a single day, or a list of days (Mon | Tue | Wed | Thu | Fri | Sat | Sun).
- Start Error Reporting Holdoff Period (seconds)
- Stop Error Reporting Holdoff Period (seconds)
- Start Error Logging Holdoff Period (seconds)
- Stop Error Logging Holdoff Period (seconds)

The changeover between configurations may cause an excessive number of spurious errors to be generated. The Error Logging and Reporting Hold-Off Periods are provided so that logging and reporting of errors can be suspended before, during and after the changeover, if required.

One schedule item must be specified as the baseline (the first item to be loaded). This allows the RTM unit to synchronize; if it is switched on in the middle of a weekly schedule for example.

The schedule will be specified in a text file using XML. An example of the schedule file format is shown below:

```
<Schedule Name="<name>" UTCOffset="<offset>">
<!--where <offset> = Local, or an offset from UTC time e.g. -60 -->
  <BaseScheduleItem>
    <!--Defines the base schedule item - there should only be one of these -->
    <ConfigurationSlot>1</ConfigurationSlot>
    <LoadTime>16:34:30</LoadTime> <!-- Load time specified in HH:MM:SS -->
    <LoadDay>Mon</LoadDay> <!-- Mon, Tue, Wed, Thu, Fri, Sat or Sun>
    <HoldOffPeriods>
      <StartErrorReporting>5</StartErrorReporting> <!-- Optional -->
      <StopErrorReporting>5</StopErrorReporting> <!-- Optional -->
      <StartErrorLogging>5</StartErrorLogging> <!-- Optional -->
      <StopErrorLogging>5</StopErrorLogging> <!-- Optional -->
    </HoldOffPeriods>
  </BaseScheduleItem>
  <ScheduleItem>
    <ConfigurationSlot>2</ConfigurationSlot>
    <LoadTime>15:00:00</LoadTime> <!-- Load time specified in HH:MM:SS -->
    <LoadDays>Mon | Tue | Wed</LoadDays>
    <!-- any combination of Mon, Tue, Wed, Thu, Fri, Sat, Sun>
    <HoldOffPeriods>
      <StartErrorReporting>5</StartErrorReporting> <!-- Optional -->
      <StopErrorReporting>5</StopErrorReporting> <!-- Optional -->
      <StartErrorLogging>5</StartErrorLogging> <!-- Optional -->
      <StopErrorLogging>5</StopErrorLogging> <!-- Optional -->
    </HoldOffPeriods>
  </ScheduleItem>
</Schedule>
```

There are two things deserving special mention in this example. First, note the BaseScheduleItem section has a LoadDay entry, and the ScheduleItem section has a LoadDays entry. If you copy and paste between the two sections, remember that the entry in the BaseSchedule section is singular and the entry in the ScheduleItem section is plural. Second, in the BaseSchedule section, there should be only a single day listed in the LoadDay entry. However, there can be multiple days listed in the LoadDays entry in the ScheduleItem section.

Scheduling Activities

NOTE. *If any changes are made to the configuration from the user interface, a warning message is displayed seeking confirmation of the action.*

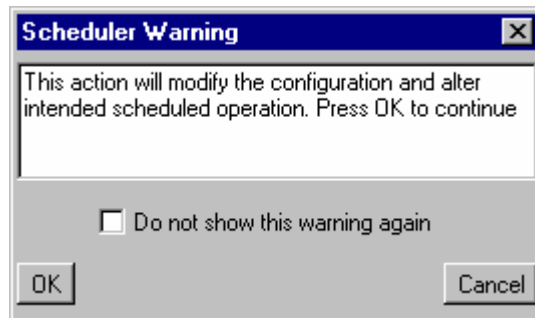

Changes made may affect the configuration that is currently loaded by the scheduler. They may also affect or be affected by future scheduled configurations.

Select **OK** to continue and accept the change made to the configuration. Select **Cancel** to close the message box; the intended change will revert to its previous setting.

With a prepared schedule file available, the following activities can be performed from the stream Configuration dialog:

Uploading a Schedule

A schedule file is uploaded from either the client PC or from a network location:

1. Select **Upload Schedule...** from the stream **Configuration** dialog.

The Upload Schedule dialog is displayed.

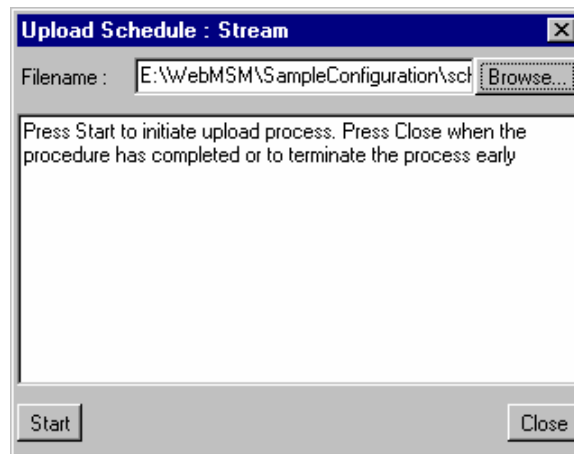

2. Enter or browse the filename of the schedule file to be uploaded to the MTM400 and select **Start**.

Select **Close** when the upload has finished or to terminate the process early.

The schedule name will be displayed in the **Current Schedule** field in the **Configuration** dialog.

Note that if the uploaded schedule is replacing a currently running schedule, the **Scheduler Enabled** checkbox in the **Configuration** dialog should be unchecked and checked to allow the new schedule to take effect.

Downloading a Schedule

A schedule file is downloaded from the MTM400 to either the client PC or to a network location:

1. Select **Download Schedule...** from the stream **Configuration** dialog.

The Download Schedule dialog is displayed.

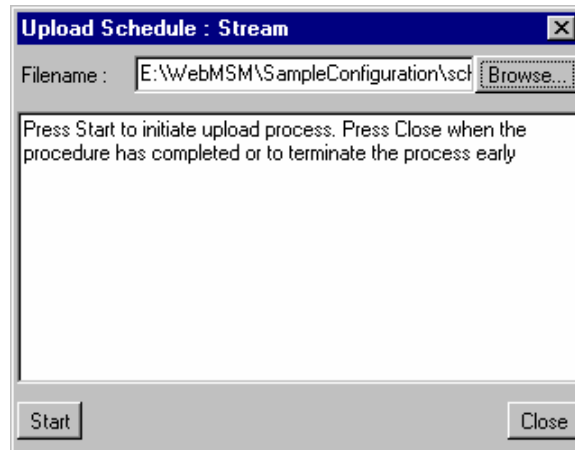

2. Enter or browse to the filename of the schedule file to be downloaded from the MTM400.
3. Select **Start**.

Select **Close** when the download has finished or to terminate the process early.

Enable Scheduling

Scheduling will not be enabled until the **Scheduler Enabled** checkbox is selected.

If an uploaded schedule is replacing a currently running schedule, the **Scheduler Enabled** checkbox in the **Configuration** dialog should be unchecked and checked to allow the new schedule to take effect.

Scheduling and Time Zones

A schedule consists of a list of schedule items that specify the times when specific configuration slots should be loaded. The schedule attribute 'UTC Offset' allows the times to be interpreted in different ways, as described below.

- Local

If you set the 'UTC Offset' attribute to 'Local', then the schedule times will represent the local times on the RTM device. For example, if the 'UTC to Time Zone Offset' of the device is -360 minutes (6 hours behind UTC) and a schedule load time is specified as 13:00, then the appropriate configuration will be loaded at 13:00 in the local time zone of the RTM device, that is 13:00 + 360 minutes = 19:00 UTC.

'UTC to Time Zone Offset' is set through **Device → Configuration → Set Time** (See page 3-8).

Having the 'UTC Offset' attribute set to 'Local' is useful where it is easier for the user to think of times in the time zone where the RTM device is installed. It is also useful where there are multiple RTM devices situated across different time zones, and configurations should be loaded in the local time of each RTM device.

Figure 3-36 shows the times at which configurations would be loaded if a schedule with the 'UTC Offset' attribute set to 'Local' containing a load time of 13:00 were used by RTM devices in several different time zones.

- User Defined Offset

You can also set the 'UTC Offset' attribute to a numeric value specifying the time zone in which the schedule is written, and independent of the RTM device. 'UTC Offset' represents the difference in minutes between the time zone that the schedule times are written in and UTC. In other words, subtract the number of minutes from the times specified in the schedule to obtain UTC time.

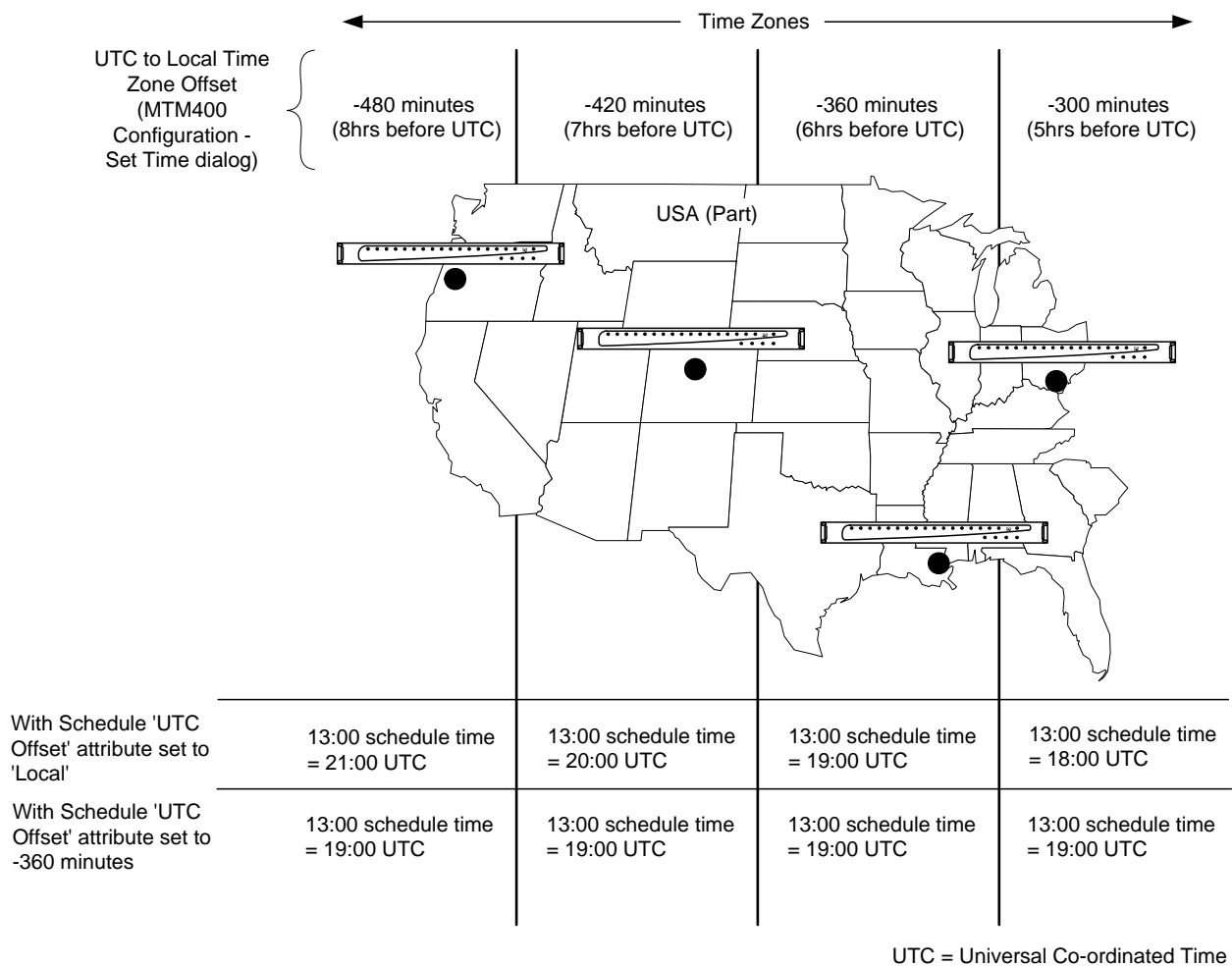

Figure 3-36: Scheduling and time zones

For example, if 'UTC Offset' is set to 60, then schedule times defined are one hour ahead of UTC. This means that if a schedule time of 11:00 is specified, the appropriate configuration should be loaded at 11:00 - 60 minutes = 10:00 UTC.

This method of operation is useful where there are multiple RTM devices monitoring a transmission chain that spans several time zones, and configurations that check features of the transport stream have to be loaded by each RTM device at the same instant in time.

Triggered Recording

To examine offline events that occur in a stream, recordings can be made whose start is triggered by the event itself, manually, or by an alarm. The recording is held in RAM and can be downloaded from the MTM400 to the client PC for storage and further analysis. The file is stored as a valid MPEG file; however extra information is encoded in the file to allow Tektronix MPEG analysis products to reconstruct the real-time timing artifacts present at the time of recording.

The Triggered Recording setup is accessed by the **Recording...** button on the Stream button bar. The **Triggered Recording** dialog box contains two panels: **Settings** and **Operation**.

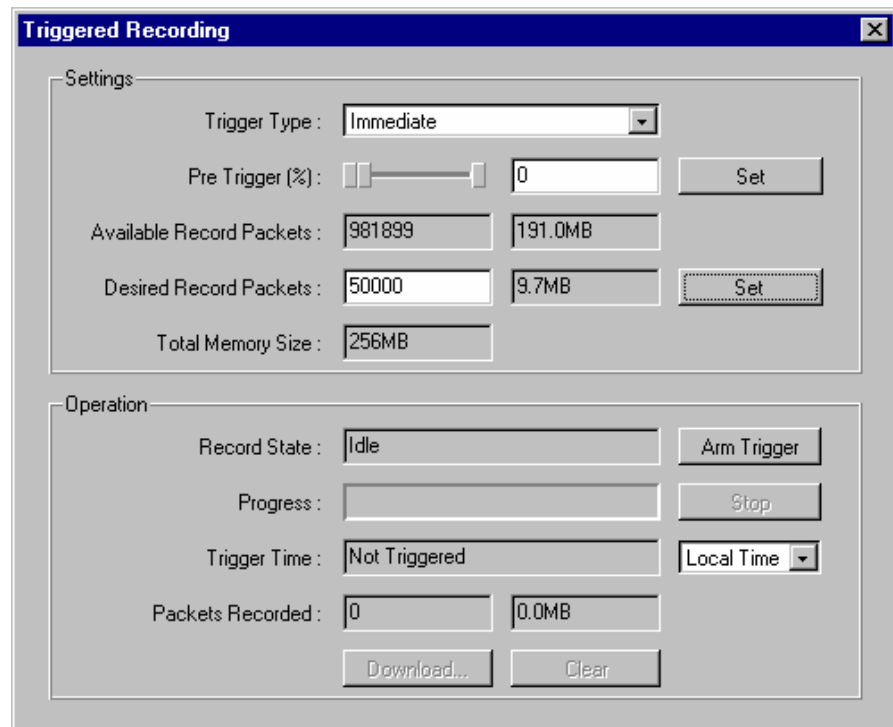
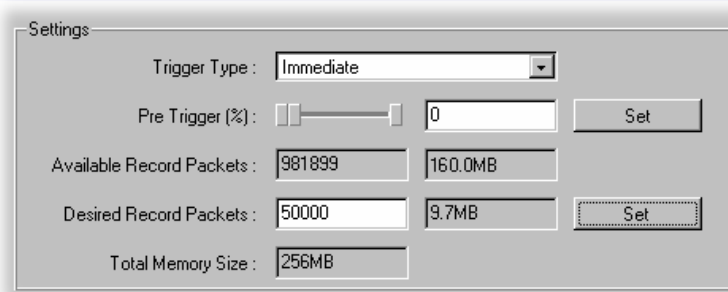

Figure 3-37: Triggered Recording dialog box

Triggered Recording Settings

The **Settings** section of the **Triggered Recordings** dialog is used to set up the trigger event, including the pre-trigger properties and the amount of memory to be reserved for the recording.



The screenshot shows a 'Settings' dialog box with the following fields and controls:

- Trigger Type:** A drop-down menu currently set to 'Immediate'.
- Pre Trigger (%):** A slider control and a text input field containing '0', with a 'Set' button to its right.
- Available Record Packets:** A text input field containing '981899' and a label '160.0MB' to its right.
- Desired Record Packets:** A text input field containing '50000' and a label '9.7MB' to its right, with a 'Set' button to its right.
- Total Memory Size:** A text input field containing '256MB'.

Trigger Type The event that triggers the recording can be one of four types, selected from the drop-down list.

Immediate

The trigger is set as soon as **Arm Trigger** is selected on the **Operations** section; in effect, recording will start immediately.

External Rising Edge / External Falling Edge

The trigger is set when **Arm Trigger** has been selected on the **Operations** section. Recording will start when a rising / falling edge is detected at the TTL input on the TS Processor, Alarms connector (see the *MTM400 Technical Reference* for specifications).

Event Alarm

The trigger is set when **Arm Trigger** has been selected on the **Operations** section. Recording will start when an error occurs on an event that has been flagged in the Tests or Custom views.

Trigger events are flagged in the Tests or Custom view by activating the **Rec** function associated with the event. In the following screen shot, test numbers 1.2 and 2.3a are set. With **Event Alarm** selected, recording will start if an error event occurs on either test.

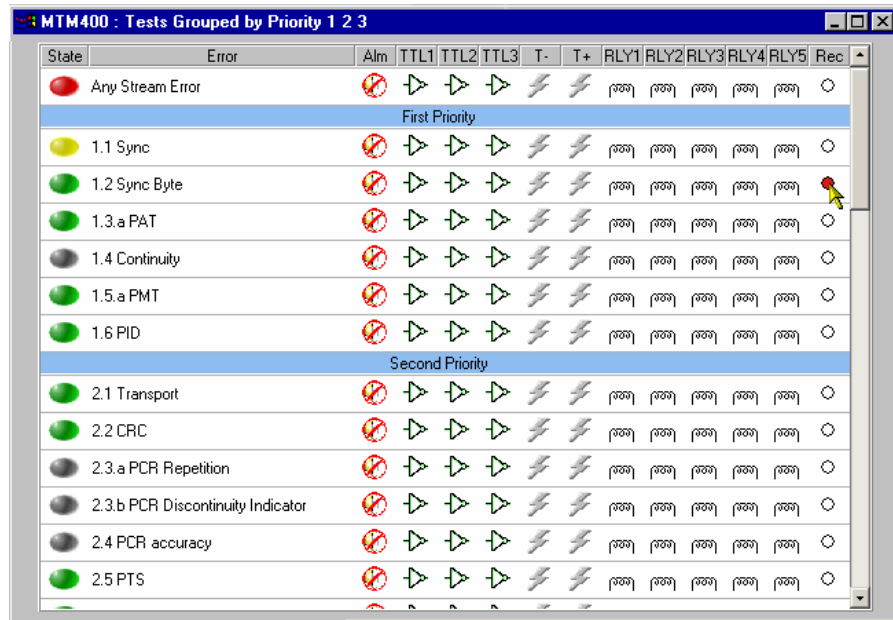

The **Rec** icon is toggle action; it is activated/deactivated by double-clicking it.

Pre Trigger (%) A percentage of a stream can be recorded before a trigger event occurs. (See *Pre-Trigger Recordings*, page 3-102.)

Set or enter the percentage of the recorded file that is to be pre-recorded and select **Set** to confirm the setting.

Available Record Packets

Two fields which indicate the maximum number of packets (at 204 bytes/packets) that can be recorded in the reserved memory and the amount of memory that will be used.

Desired Recording Packets

Two fields which indicate the number of packets (at 204 bytes/packets) that are to be recorded in the reserved memory (**Total Memory Size**) and the amount of memory that will be used.

Enter the number of packets required and select **Set** to confirm the setting.

NOTE. Any value can be entered in the **Desired Record Packets** field. The required memory will be calculated and displayed, even if it exceeds the available memory. However, when recording actually starts, the entered value is automatically adjusted to reflect the available memory.

Total Memory Size

Displays the total available system memory.

Pre-Trigger Recordings

A percentage of a stream can be recorded before a trigger event as specified by the Pre-Trigger setting. The start of recording is dependent upon the selected trigger type. However, the stream is being recorded in memory at all times; the available memory is used as a circular buffer, in that it is filled and written over continuously until a trigger event occurs.

NOTE. A Circular Buffer is an area of memory used to store a continuous stream of data by starting again at the beginning of the buffer after reaching the end.

As soon as the trigger event occurs, recording will commence. Recording continues until the memory buffer is full. The recording will remain in memory until it is manually cleared, typically after it is uploaded to a client PC.

The Pre-trigger set up can be changed only when no recording activity is in progress.



The Pre-trigger setting allows the proportion of data saved *before* a trigger event to be specified as a percentage of the final recorded file. Editing the value or dragging the slider in the tab can change the proportions.

The proportion of pre-trigger data may be less than specified if the trigger event occurred before enough packets were recorded in the circular buffer (particularly after clearing the buffer).

For example, if the available memory will hold a 20 second recording, with 25% pre-trigger specified and an event-triggered recording starting five seconds or more into the run, the contents of the recorded file will be:

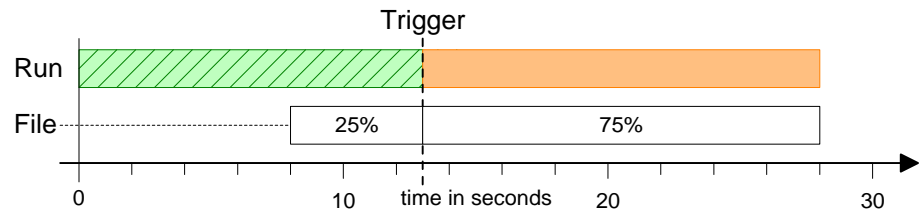

If the Trigger event was detected earlier than five seconds into the run, the 20 second file will contain all of the data up to the Trigger. If recording was triggered at three seconds only the first 15% of the file would hold pre-trigger data. The file contents would be:

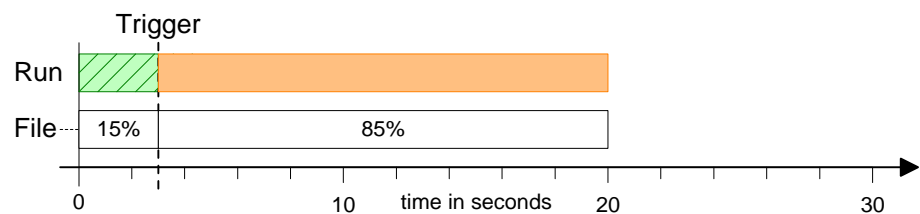

Triggered Recording Operation

The **Operation** section of the **Triggered Recordings** dialog is used to arm the trigger before recording and shows the status of the recording activity.



- Arm Trigger** Use this button to set or arm the trigger event set up in the Settings panel.
- Stop** Use this button to disarm the previously armed trigger or to stop the current recording. Any recording made up to the point when the button is pressed will be available for analysis.
- Record State** This field indicates the current state of the Pre-trigger function. Possible states are:
- Idle** - Pre-Trigger not armed.
 - Waiting to Trigger** - Armed and waiting for the trigger event to occur.
 - Recording in Progress...** - Trigger event has occurred and recording is in progress.
 - Recording complete** - The recording is complete and available for downloading and clearing.
- Progress** Displays the progress of recording.
- Trigger Time** Displays the time that the trigger event occurred.
- The time zone in which trigger times are presented can be selected from the drop-down list:
- Local** - the time local to the machine on which MTM400 Remote User Interface is currently running.
 - UTC** - Universal Coordinated Time.
 - RTM Device** - the time local to the RTM device being monitored.

Packets Recorded

Displays the number of packets recorded and the amount of memory used.

Download...

Select and enter the location to which the recorded stream is to be saved.

Clear

Clears the current recording. Background recording (for the pre-trigger) will start again immediately.

Interface Configuration and Interpretation

This section describes the configuration and interpretation of results of the interface cards that may be installed in the MTM400.

The interface settings described are as follows:

- QPSK (L-Band)
- QAM (Annex A)
- QAM (Annex B II)
- QAM (Annex C)
- COFDM (Coded Orthogonal Frequency Division Multiplexing)
- 8PSK (Phase Shift Keying)
- 8VSB (Vestigial Side Band)

The interface card options available for the MTM400 fall into two broad categories. Standard interface cards and Common interface protocol (CIP) cards. The Standard interface cards include the QPSK (L-Band), QAM (Annexes A) and QAM (Annex C) cards. The Common Interface Protocol Cards include the QAM (Annex B), COFDM, 8PSK, and 8VSB cards.

Also available are the built-in SMPTE (Society of Motion Picture and Television Engineers) and ASI (Asynchronous Serial Interface) interfaces. No user settings are associated with either of these interfaces.

(Refer to the *MTM400 MPEG Transport Stream Monitor Technical Reference* for the interface technical specifications.)

The input card screen and configuration of the card will depend on the interface card installed.

All cards can be configured from the interface configuration screen:

1. Select **Config...** button; the Configuration screen is displayed.
2. Select the interface card from the Interface drop-down list.
3. Select the adjacent **Config...** button; the Configuration screen is displayed.

Note. *CIP cards can also be configured from the Input Card screen.*

To summarize:

- All cards can be selected and configured using the configuration screen (use the Config button).
- The results and measurements of the installed card can be observed using the Input Card button.
- CIP card configuration, results and measurements can all be done using the Input Card button.

The Input Card button on the button bar will be inactive (that is, dimmed) if an interface card is fitted, but not selected in the Configuration screen. The button will not be present if no interface card is installed. Also, when active, the button will only display red and green states; this indicates the interface card stream lock status (also displayed on the configuration screen).

In the Input Card screen, the settings area (right-hand side) contains two sub-areas. The Readings area displays values received from the card itself. A yellow background to the reading indicates that the reading has not been recently updated. The Controls area contains user controls; values entered here will be applied to the card and affect its performance. These controls correspond exactly with those on the corresponding configuration screen.

QPSK (L-Band)

The QPSK (L-Band) Interface option allows you to connect to QPSK equipment operating in the L-Band (950 MHz to 2150 MHz). It will internally I-Q demodulate the signal with its on-board AGC control, Viterbi decoder, and FEC decoder.

The module will tune the full Satellite IF band, which is considerably wider than the L-Band itself. As LNB support is included, this allows the module to be used with a stand-alone TVRO dish.

The input to the interface card is looped through to the output connector, allowing subsequent processing of the input signal.

The L-Band Interface allows you to monitor and/or record the transport streams from within the L-Band signal.

Bit Error Rate (BER) values are available during operation.

Configuration - QPSK (L-Band)

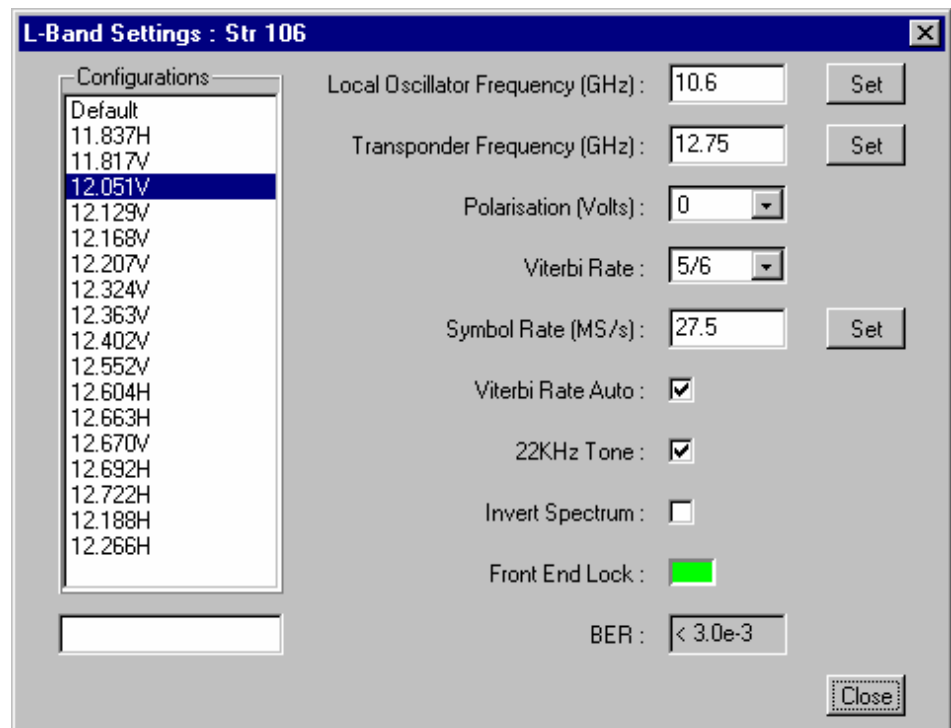

Figure 3-38: Interface configuration - QPSK (L-Band)

Configurations Allows you to select from a range of preset L-Band configurations.

The configurations are made available by the MTM400 configuration file (see *MTM400 Configuration Files*, page 3-85.).

You can activate an L-Band configuration by highlighting the name in the **Configurations** field; the field below will display the message 'Updating values' until the settings are recalled.

Local Oscillator Frequency (GHz)

The Local Oscillator (LO) frequency of the Low Noise Block (LNB) is dependent on the Transponder frequency and must be such that the difference falls within the input range of the receiver. Typically, these values are 10.6 GHz (Hi-Band) and 9.75 GHz (Lo-Band) when converting from KU band. The values are 5.7 GHz (Hi-Band) and 5.15 GHz (Lo-Band) respectively when converting from C-Band. This information should be confirmed for the specific type of LNBs used.

Enter the required value and select **Set**.

Transponder Frequency (GHz)

The IF frequency that is used to initialize the L-Band Interface card is calculated as follows:

$$\text{Transponder_Frequency} - \text{LO_Frequency.}$$

If you want to specify the IF frequency rather than the individual LO and Transponder frequencies, set the Local Oscillator Frequency to a value of 0 (zero) and specify the required IF frequency under this parameter. If the IF frequency is specified, it must be in the range 0.950 GHz to 2.150 GHz; the tuning increment is 125 kHz.

Enter the required value and select **Set**.

Polarisation (Volts)

This parameter selects the polarization by applying 13 V (vertical) or 18 V (horizontal) to the LNB (Low Noise Block). A value of 0 can be used if no voltage is to be applied from this card; for example, if the polarization voltage is being supplied from an external source.

Viterbi Rate Select the code rate from the drop-down list: 1/2; 2/3; 3/4; 5/6; 6/7; 7/8. Note that it may be overwritten if the Viterbi Rate Auto selection is enabled.

Symbol Rate (MS/s)

Symbol rate value in mega symbols per second.
Enter the required value and select **Set**.

Viterbi Rate Auto

When enabled, the L-Band adapter automatically establishes the Viterbi Rate when acquiring Front End Lock.

NOTE. *The Viterbi Rate Auto option will not work correctly if the Viterbi rate is 5/6. If this rate (5/6) is known, or suspected, then the Auto option should not be used.*

22KHz Tone

The Local Oscillator Frequency is selected by applying a 22 kHz tone.

Invert Spectrum The sense of modulation may be inverted due to the number of mixing stages in the installation. Enabling the Invert Spectrum checkbox will invert the L-Band output.

Front End Lock If the L-Band adapter Front End is able to acquire full lock onto the channel and is receiving the signal correctly, the **Front End Lock (FEL)** indicator will light up green. When a signal is present but no lock is achieved the indicator is red. When no signal is found, the indicator is gray.

BER

Bit Error Rate.

Input Card Screen - QPSK (L-Band)

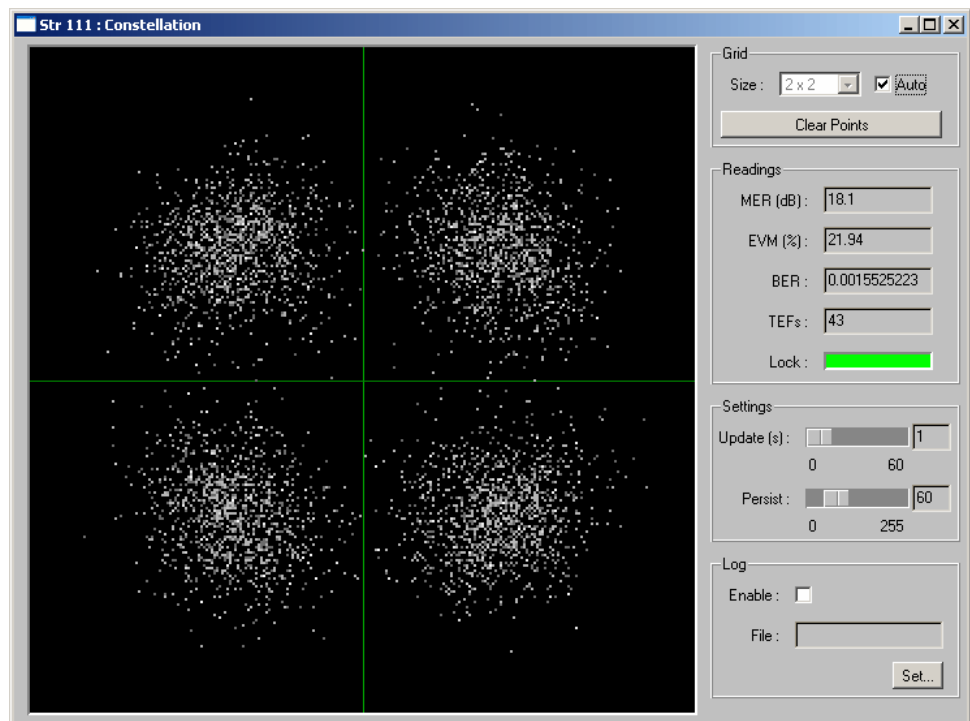

Figure 3-39: Input card screen - QPSK (L-Band))

The constellation display in the graphing area is a representation of the digitally modulated carrier's instantaneous phase and amplitude for each transmitted symbol. A good constellation will have well-defined dot clusters in tight formations; each cluster should be centered in a grid overlay square. The overall shape of the dot clusters should form a square as represented by the outer edges of the grid.

The Grid area of the screen contains the following controls:

Size This selection will be dictated by the installed interface card. If the **Auto** checkbox is selected, the grid size can be selected from the drop-down list.

Clear Points Clears all points from the display grid.

The Readings area of the screen contains the following controls:

MER (dB) (Modulation Error Ratio) Provides a single 'figure of merit' for received signal. It is the ratio of 'ideal signal vectors' to 'errored signal vectors' expressed in dB. MER is similar to a signal-to-noise measurement (ref: TR 101 290).

EVM (%)	(Error Vector Magnitude) Closely related to, and can normally be calculated from, MER. It is a ratio of 'errored signal vectors' to maximum signal amplitude expressed as a percentage (ref: TR 101 290 Annex).
BER	(Bit Error Rate) Provides an indication of the Forward Error Correction workload.
TEFs	(Transport Error Flag or TEI transport error indicator) Indicates the Forward Error Correction failure.
Lock	If the interface is able to acquire full lock onto the channel and is receiving the signal correctly, the Lock indicator will light up green. Red indicates that lock cannot be achieved. Gray indicates that a signal is not present.

The Settings area of the screen contains the following controls:

Update (s)	Allows the period in seconds between samples of the incoming signal to be set.
Persist	Allows the time that the dots persist on the grid display to be set.

The Log area of the screen contains the following controls:

File	Constellation data can be written to the file identified in this field; data is saved in csv format.
-------------	--

QAM (Annex A and Annex C)

The QAM Annex A and Annex C interfaces have common settings. The Annex A interface appears as shown in Figure 3-40:

Configuration - QAM (Annex A and Annex C)

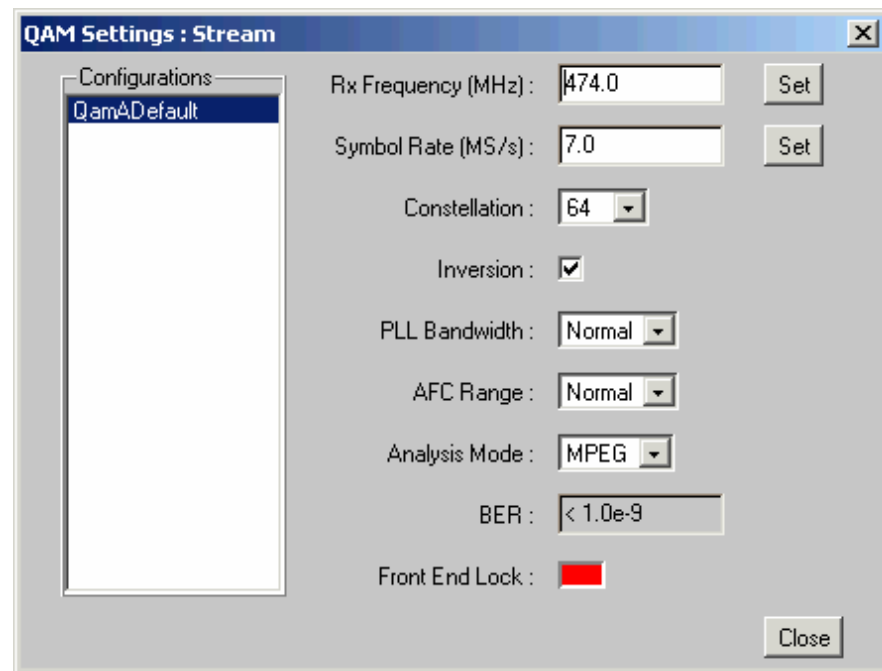

Figure 3-40: Interface configuration - QAM (Annex A and Annex C)

Configurations The **QAM Settings** dialog provides an option to recall a number of settings configuration files. The configuration files are created and stored in the MTM400. To select a configuration file, highlight the required name in the list.

Rx Frequency (MHz)

Receive frequency.
Enter the required value and select **Set**.

Symbol Rate (MS/s)

Symbol rate value.
Enter the required value and select **Set**.

Constellation	Provides the option to set the modulation scheme: 4-QAM, 16-QAM, 64-QAM or 256-QAM. Select the required value from the drop-down list.
Inversion	The sense of modulation may be inverted due to the number of mixing stages in the installation. Enabling the Inversion checkbox will allow the demodulator to lock onto a received signal with an inverted spectrum.
PLL Bandwidth	This control modifies the bandwidth of the carrier phase recovery loop, which is responsible for de-rotating the incoming symbols to establish a steady constellation. Two settings are available: Normal and Wide . In Normal mode, the loop bandwidth is approximately 3 kHz, which gives optimum immunity to noise in the channel for most applications. In some cases, the loop bandwidth may be too narrow to follow the jittered signal, in which case the Wide bandwidth setting should be selected. This increases the loop bandwidth to about 10 kHz, which enables the MTM 400 to more easily acquire and track a jittered constellation, but makes the demodulator more susceptible to thermal noise. Normal is the default setting and is recommended for most applications.
AFC Range	Two carrier recovery ranges are available: Normal and Wide . In Normal mode, the range is approximately ± 150 kHz. In Wide mode, the range is increased to ± 500 kHz. Normal setting is the default setting and is recommended for most applications.
Analysis Mode	Two settings are available: MPEG mode and QAM mode . In MPEG mode, the lock condition is declared as “No Lock” if a valid transport stream cannot be detected. This prevents spurious streams from being fed to the MPEG processor for analysis. In QAM mode, the validity of the MPEG stream is ignored, possibly resulting in spurious MPEG analysis, but allowing lock to be asserted if the QAM receiver front end sees a valid QAM signal. This allows the display of RF data and constellations even if the MPEG data is not valid. In QAM mode, the MTM400 behaves more like a conventional QAM analyzer. MPEG mode is the default setting and is recommended for most applications. The range controls, PLL bandwidth and AFC range, are operable in both MPEG and QAM analysis modes.
BER	Bit Error Rate (pre Reed Solomon).

Front End Lock If full lock is acquired onto the channel and it is receiving the signal correctly, the **Front End Lock (FEL)** indicator will light up green. When a signal is present but no lock is achieved the indicator is red. When no signal is found, the indicator is gray.

(Refer to the *MTM400 MPEG Transport Stream Monitor Technical Reference* for more details about the QAM interfaces.)

Input Card Screen - QAM (Annex A and Annex C)

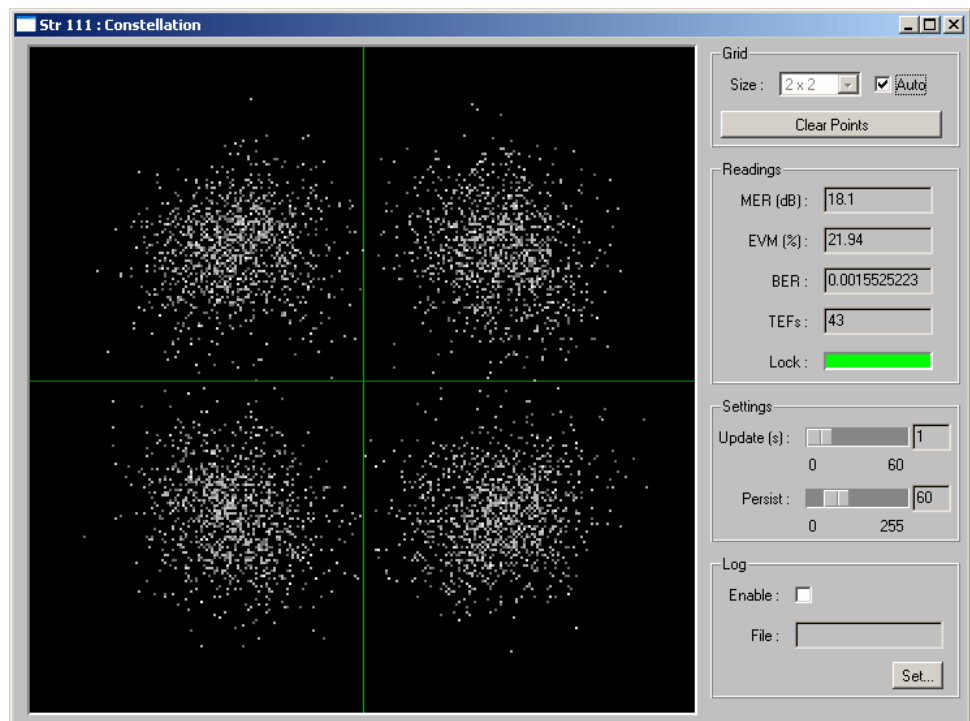

Figure 3-41: Input card screen - QAM (Annex A and Annex C)

The constellation display in the graphing area is a representation of the digitally modulated carrier's instantaneous phase and amplitude for each transmitted symbol. A good constellation will have well-defined dot clusters in tight formations; each cluster should be centered in a grid overlay square. The overall shape of the dot clusters should form a square as represented by the outer edges of the grid.

Grid

Size This selection will be dictated by the installed interface card. If the **Auto** checkbox is selected, the grid size can be selected from the drop-down list.

Clear Points	Clears all points from the display grid.
Readings	
MER (dB)	(Modulation Error Ratio) Provides a single 'figure of merit' for received signal. It is the ratio of 'ideal signal vectors' to 'errored signal vectors' expressed in dB. MER is similar to a signal-to-noise measurement (ref: TR 101 290).
EVM (%)	(Error Vector Magnitude) Closely related to, and can normally be calculated from, MER. It is a ratio of 'errored signal vectors' to maximum signal amplitude expressed as a percentage (ref: TR 101 290 Annex).
BER	(Bit Error Rate) Provides an indication of the Forward Error Correction workload.
TEFs	(Transport Error Flag or TEI transport error indicator) Indicates the Forward Error Correction failure.
Lock	If the QAM interface is able to acquire full lock onto the channel and is receiving the signal correctly, the Lock indicator will light up green. Red indicates that lock cannot be achieved. Gray indicates that a signal is not present.
Settings	
Update (s)	Allows the period in seconds between samples of the incoming signal to be set.
Persist	Allows the time that the dots persist on the grid display to be set.
Log	
File	Constellation data can be written to the file identified in this field; data is saved in csv format.

QAM (Annex B II)

The QAM (Annex B II) Settings dialog box is shown in Figure 3-42.

Configuration - QAM (Annex B II)

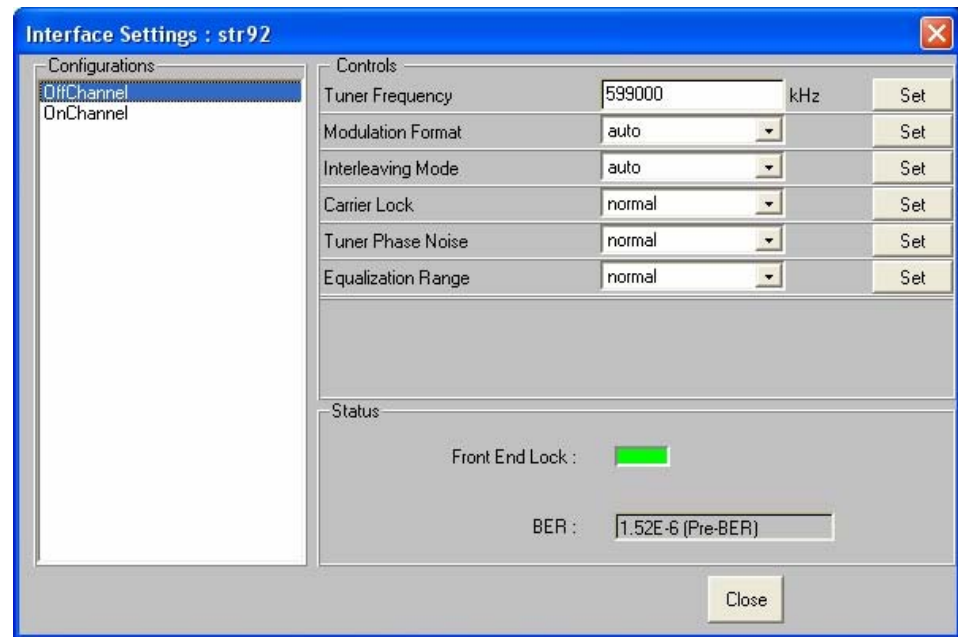

Figure 3-42: Interface configuration – QAM Annex B II

For each of the settings, enter the required change and select **Set** to apply the new value. The settings are as follows:

NOTE. *These settings can also be made from the Input Card screen.*

Configurations: The QAM Settings dialog provides an option to recall a number of settings configuration files. The configuration files are created and stored in the MTM400. To select a configuration file, highlight the required name in the list.

Tuner Frequency (kHz):

This value, set in kHz units, is the center frequency of the channel to be received. Any frequency can be entered. There is no need to follow a channel plan. The frequency resolution is determined by the tuner step size of 62.5 kHz.

Modulation Format:

This drop-down list allows 64 QAM or 256 QAM operation to be selected. Note that SCTE07 and ITU-Tj83 annex B specify exact symbol rates for the two modulation formats, so there is no dialogue box to enter the symbol rate separately.

Interleaving Mode:

Interleaving assists in the correction of burst noise induced errors. All interleaving modes mentioned in SCTE 07 are supported, including all Level II modes up to $I = 128$ $J = 6$.

Carrier Lock:

This allows the carrier lock range to be increased from the normal ± 150 kHz to approximately ± 500 kHz. This is useful if you are attempting to lock on to badly mistuned or wandering carriers.

Tuner Phase Noise:

This control modifies the carrier loop bandwidth to allow the acquisition of nosy carriers. Normal mode is recommended for general use.

Equalization Range:

The channel equalizer can be configured to give a long equalization range, at the expense of equalizer resolution, or, in normal mode, optimized for typical cable environments. Normal mode is recommended for general use.

Front End Lock If full lock is acquired onto the channel and it is receiving the signal correctly, the **Front End Lock** (FEL) indicator will light up green. When a signal is present but no lock is achieved, the indicator is red. When no signal is found, the indicator is gray.

BER (Pre-BER) Bit Error Rate ahead of the FEC block. The Pre RS BER is calculated by counting the number of errored blocks successfully corrected by the FEC.

BER (Post-BER) Bit Error Rate after the FEC block. The Post RS BER is calculated by counting the number of errored blocks unsuccessfully corrected by the FEC.

Input Card Screen - QAM Annex B II

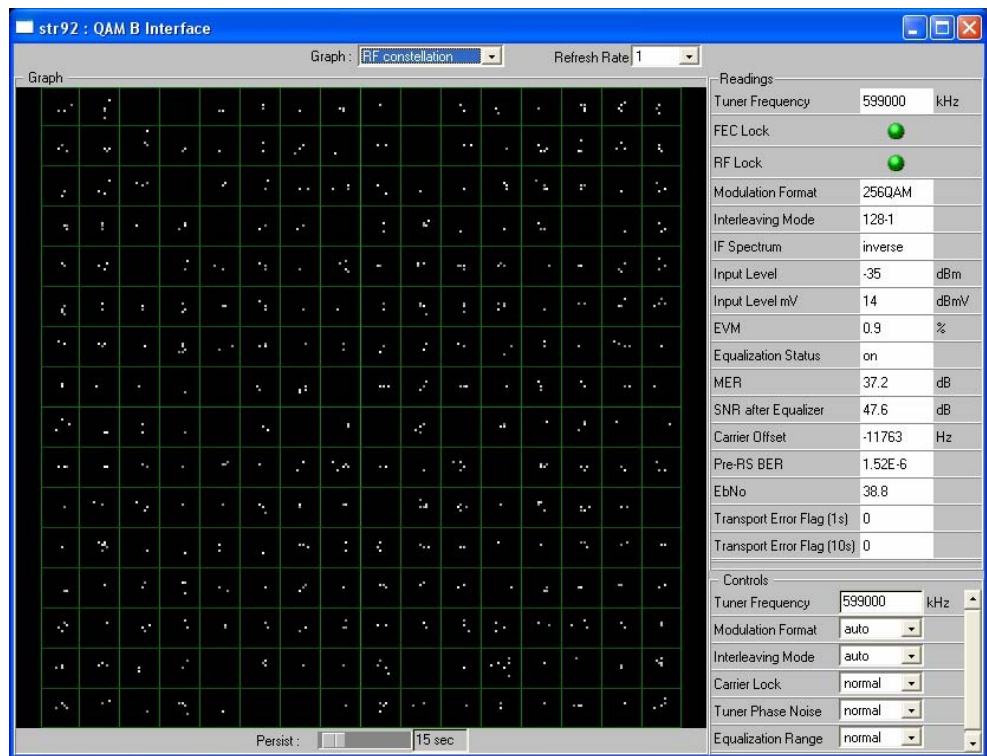

Figure 3-43: Input card screen - QAM Annex B II (example)

Two LED indicators are available on the Readings section of the screen:

- FEC Lock** Forward Error Correction Lock, which displays the status of the deinterleaver and Reed Solomon decoder.
- RF Lock** If full lock is acquired onto the channel and it is receiving the signal correctly, the RF Lock indicator will light up green. When a signal is present but no lock is achieved, the indicator is red. When no signal is found, the indicator is gray.

The following graphs, which can be selected from the **Graph** drop-down list, are available when the QAM (Annex B) interface card is installed:

- RF Constellation** I and Q data are collected from the QAM front end and displayed as a conventional constellation of 256 points by 256 points. The samples collected are not real time, so there is some dwell (delay) before a complete constellation is displayed. The persistence of the display can be varied using the **Persist** slider control at the bottom of the graph.

MER and EVM calculations are performed on the constellation data according to the formulas given in ETR290-101.

SNR after equalizer

This graph represents the signal-to-noise ratio over time, typically over 256 seconds. It is useful for examining signal-to-noise trends; for example, if an alarm condition has been breached, the graph can be used to examine trends in the signal-to-noise performance before the alarm occurred.

Equalizer

This graph shows the status of the equalizer taps, and gives an estimate of the channel state. If there are echoes or other time related distortions on the signal, the Equalizer display will display the amplitude of the corresponding tap correction values versus time.

NOTE. *The Equalizer graph amplitude values are only approximate.*

MER

This graph gives a time record of MER over the last 255 seconds.

Select the graph to be displayed from the Graph drop-down menu.

COFDM

The COFDM (Coded Orthogonal Frequency Division Multiplexing) Settings dialog box is shown in Figure 3-44.

Configuration - COFDM

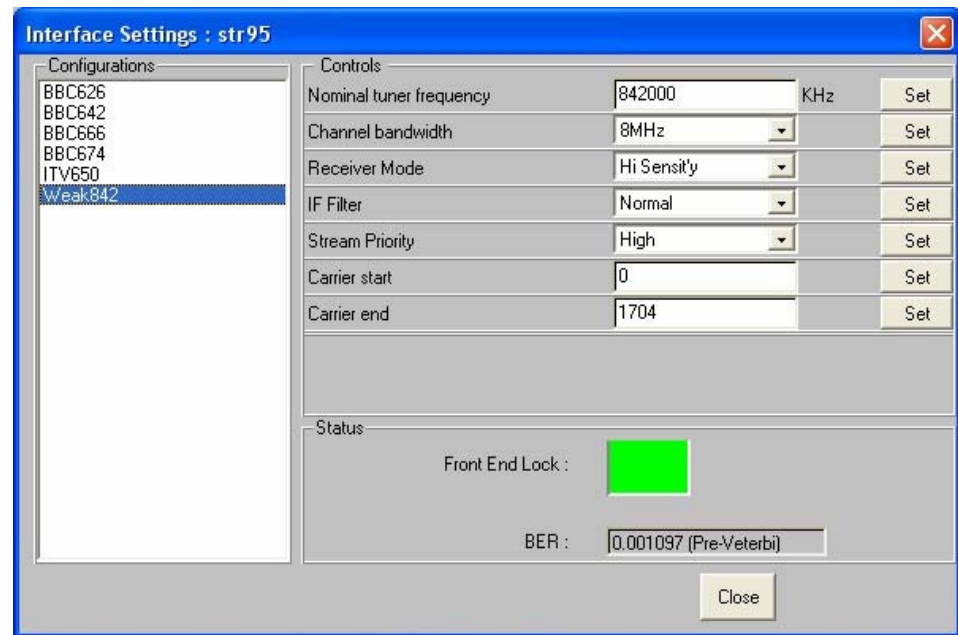

Figure 3-44: COFDM interface configuration (example)

For each of the settings, enter the required change and select **Set** to apply the new value.

NOTE. *These settings can also be made from the Input Card screen.*

Nominal Tuner Frequency:

This value, set in kHz units, is the center channel frequency of the DVB-T channel to be received. For example, to receive channel E21, set this value to 474000 kHz. Any frequency can be entered. There is no need to follow a channel plan. The frequency resolution is determined by the tuner step size.

Channel Bandwidth:

The COFDM interface card supports operation in 8 MHz, 7 MHz, and 6 MHz channels. Select the desired channel bandwidth from the drop-down menu.

Receiver Mode: In order to achieve high accuracy measurements, particularly for MER and SNR measurements, the COFDM IF card supports two modes of operation.

For conventional COFDM reception, a relatively low ultimate SNR is acceptable. For example at 64QAM, an ultimate receiver SNR of 30 dB can result in a reduction in system performance of only 0.5 dB. However, for more detailed analysis of COFDM constellations, a much higher ultimate SNR is required, preferably in excess of 40 dB. For this reason, two modes of COFDM operation are provided.

High Sensitivity mode gives the full dynamic range of a conventional COFDM receiver, but at the expense of ultimate SNR. The **High Resolution** mode modifies the signal path to dramatically reduce the noise generated in the receiver, giving a much higher ultimate SNR, but at the expense of receiver sensitivity. So for general purpose monitoring where the input signal may vary over a wide range, typically -75 dBm and lower, high sensitivity mode is preferred.

If the signal is consistently greater than -50 dB, high resolution mode provides better RF measurement performance.

IF Filter The COFDM receiver incorporates two stages of selectivity. One of these can be bypassed in WIDE mode to give a more accurate representation of the input spectrum flatness (at the expense of overall selectivity).

Stream Priority When hierarchical modulation is present, the transport stream priority, HIGH or LOW, can be selected for analysis by the MPEG analyzer tools. When no hierarchy is present, this defaults to HIGH priority.

Carrier start When observing carrier amplitudes ahead of the channel equalizer, this value sets the numerical value of the first carrier to be displayed, and defaults to zero.

Carrier end When observing carrier amplitudes ahead of the channel equalizer, this value sets the numerical value of the last carrier to be displayed, and defaults to the maximum carrier number in the COFDM signal (1704 for 2K, 6816 for 8K modes).

Front End Lock If full lock is acquired onto the channel and it is receiving the signal correctly, the **Front End Lock** (FEL) indicator will light up green. When a signal is present but no lock is achieved, the indicator is red. When no signal is found, the indicator is gray.

BER (Pre-Viterbi)

This indicator reads the BER in the channel, before any error correction is applied.

Input Card Screen - COFDM

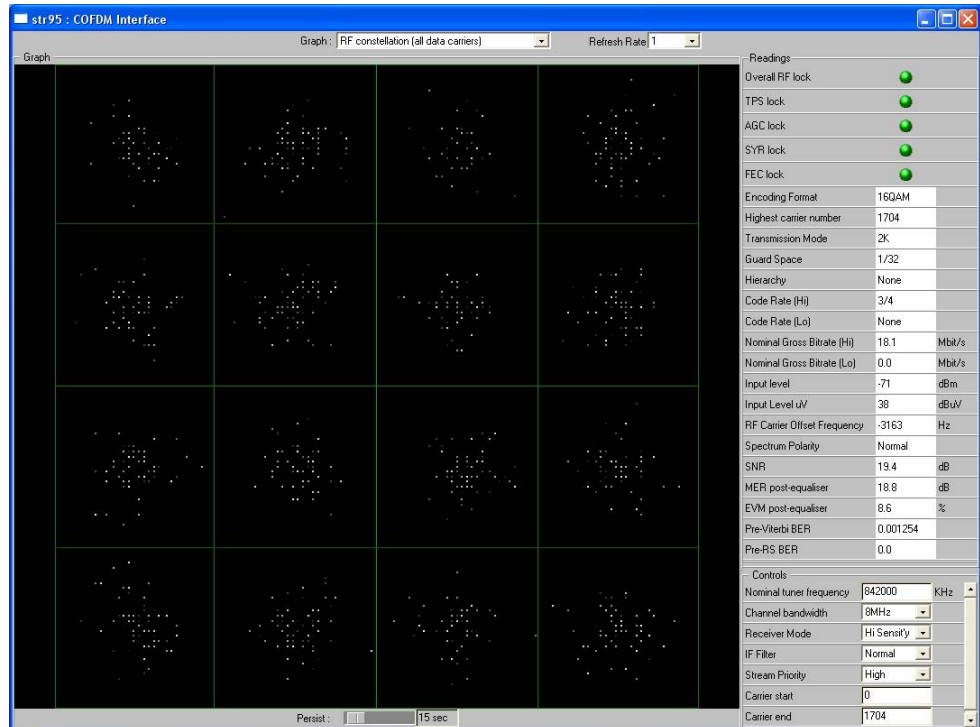

Figure 3-45: Input card screen - COFDM (Example)

Five LED indicators are available on the Readings section of the screen:

Overall RF Lock:

All the lock indicators are showing “in lock”, and the signal is being received normally.

TPS Lock

Transmission Parameter Lock, showing true if the ruggedly modulated TPS is being received.

AGC Lock

Automatic Gain Control lock, showing the received signal is within AGC control range.

SYR Lock

Symbol Recovery Lock, showing that the FFT symbol recovery system is in lock, allowing constellation data to be extracted.

FEC Lock

Showing the Reed Solomon Forward Error Correction system is in lock, and applying error correction to the received data.

The following graphs are available when the COFDM interface card is installed:

RF constellation (all data carriers)

When the receiver is in RF lock, the constellation points are displayed. Note that according to ETR290, only the data pilots are used for MER and EVM calculation. The samples collected are not real time, so there is some dwell (delay) before a complete constellation is displayed. The persistence of the display can be varied using the Persist slider control at the bottom of the graph.

MER and EVM calculations are performed on the constellation data according to the formulae given in ETR290-101. Note that this calculation specifically excludes the TPS carriers.

Overall SNR (all continuous pilots)

A time-line graph of measured Signal-to-Noise Ratio is displayed, over a period of the preceding 255 seconds.

Overall MER (all data carriers)

A time-line graph of measured Modulation Error Ratio is displayed, over the preceding 255 seconds.

Linear Amplitude response (selected carriers)

A linear amplitude response is shown for the carriers selected using the carrier START and STOP controls. Allows you to view and zoom in on frequency-dependent amplitude distortions.

Impulse response

A channel response graph is shown, allowing time-related distortions, particularly echoes, to be displayed relative to the main signal. Echoes occurring before and after the main signal are displayed. It is derived from the linear amplitude response, transformed into the time domain.

8VSB

The 8VSB (Vestigial Sideband) Settings dialog box is shown in the following screenshot:

Configuration - 8VSB

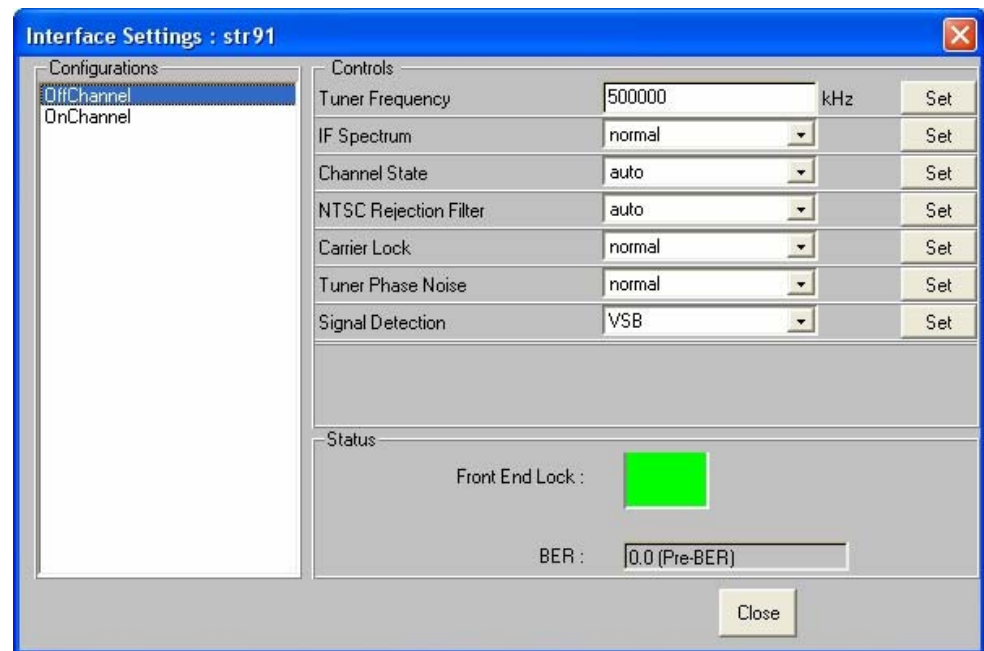

Figure 3-46: 8VSB interface configuration (example)

For each of the settings, enter the required change and select **Set** to apply the new value.

NOTE. *These settings can also be made from the Input Card screen.*

Configurations This dialog box provides an option to recall a number of settings configuration files. The configuration files are created and stored in the MTM400. To select a configuration file, highlight the required name in the list.

Tuner Frequency (kHz)

Enter the required tuned (channel) frequency. Remember to enter the center channel frequency, not the “pilot” frequency.

- IF Spectrum** This can be set to **Normal** or **Inverse**, to allow for frequency conversions in the signal chain. Conversions that use difference frequencies invert the spectrum; additive conversions do not.
- Channel State** Available options are **auto**, **static**, **dynamic** and **fast dynamic**. Using these options you can match the receiver equalizer to the expected channel conditions. The recommended default setting is **auto**.
- NTSC Rejection Filter**
This setting gives you control over the integrated cochannel NTSC reject filter. Options are **on**, **off** and **auto**. The recommended default setting is **auto**.
- Carrier Lock** This setting allows you to control the carrier lock range. The **Normal** setting allows lock over a ± 150 kHz range; **Wide** extends the range to ± 500 kHz. The recommended default setting is **Normal**.
- Tuner Phase Noise**
Normal and **High**. This control modifies the carrier loop bandwidth to allow the acquisition of nosiy carriers. Normal mode is recommended for general use.
- Signal Detection** **NTSC** (National Television Standards Committee) and **VSB** (Vestigial Side Band).
- Front End Lock** If full lock is acquired onto the channel and it is receiving the signal correctly, the **Front End Lock** (FEL) indicator will light up green. When a signal is present but no lock is achieved, the indicator is red. When no signal is found, the indicator is gray.
- BER** BER is displayed, measured before the Reed Solomon forward error correction block.

Input Card Screen - 8VSB

One LED indicator is available in the Readings section of the screen:

RF Lock This indicates that all decoding systems are in lock and the signal is being decoded normally.

The following graphs are available when the 8VSB interface card is installed:

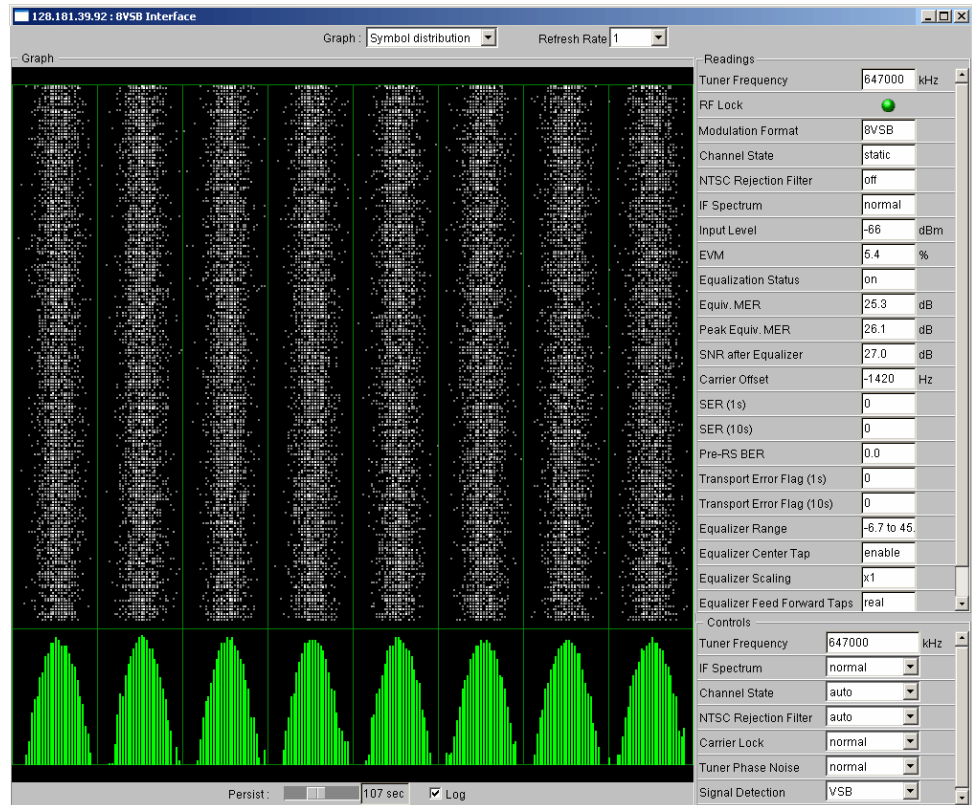

Figure 3-47: Input card screen - 8VSB (Example)

Symbol Distribution

This graph shows the samples received over time in a falling vertical line display. In a noise-free system, all samples would fall on one of the eight vertical lines. However, in normal systems the samples will be displayed distributed around the vertical lines. At the bottom of the graph display, the sample values are accumulated into a distribution histogram. The histogram can be displayed in a linear or logarithmic format.

Signal to Noise (SNR) (after equalizer)

The SNR values are plotted in a pen-trace style, giving a brief history of the collected values.

Equalizer The equalizer coefficients are plotted across the graph display. The display illustrates the presence of multi-path echoes by indicating how the equalizer is adjusting to cancel them out.

NOTE. *The Equalizer graph amplitude values are only approximate.*

Equivalent MER An MER (Modulation Error Ratio) calculation is performed on the in-phase (I) data samples. The quadrature data samples are ignored in this calculation.

8PSK (Phase Shift Keying)

The 8PSK Settings dialog box is shown in the following screenshot:

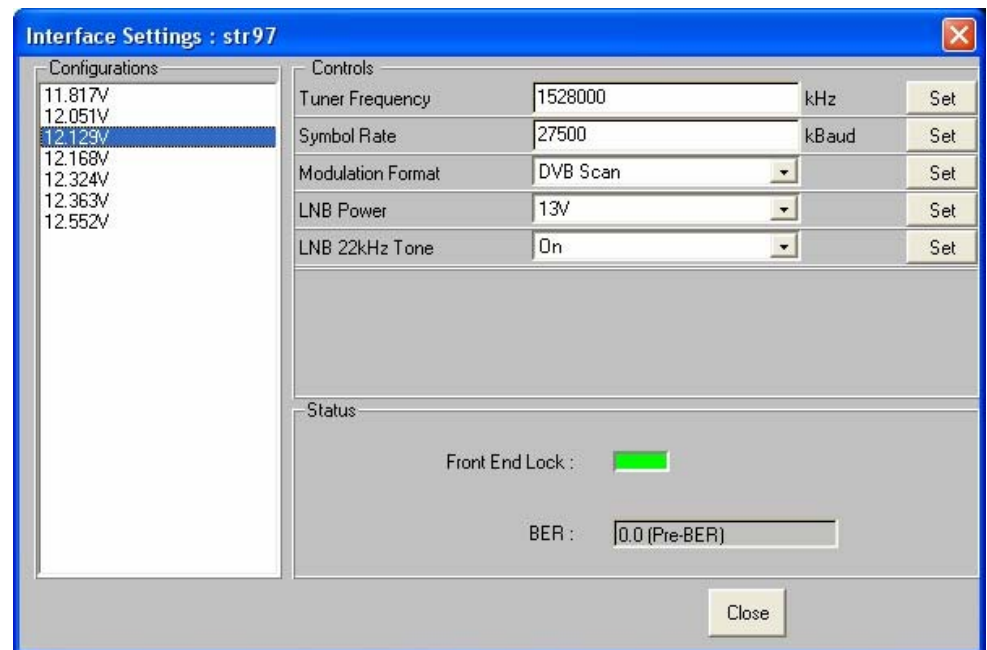

Figure 3-48: 8PSK interface configuration (example)

For each of the settings, enter the required change and select **Set** to apply the new value.

NOTE. *These settings can also be made from the Input Card screen.*

Configurations: This dialog box provides an option to recall a number of settings configuration files; for example, prestored transponder parameters. The configuration files are created and stored in the MTM400. To select a configuration file, highlight the required name in the list.

Tuner Frequency (kHz):

This value is the center frequency of the IF channel to be received (that is, after downconversion in the LNB where applicable). Any frequency can be entered; there is no need to follow a channel plan. The frequency resolution is determined by the tuner step size of 1 MHz.

Symbol Rate (kBaud):

This value is the symbol frequency (Baud rate) of the signal to be received, over a range of 1 to 30 MBaud. You need to enter the symbol rate to a typical accuracy of 1000 ppm to ensure successful lock.

Modulation Format:

The card supports a number of modulation formats: Turbo FEC 8PSK, Turbo FEC QPSK, DVB QPSK and Digicipher™ II. Enter the appropriate format and puncture rate (also known as the code rate) into the modulation dropdown dialog box. A **Scan** function is also provided, allowing automatic acquisition if the precise code rate is not known.

LNB Power:

The QPSK/8PSK card incorporates a regulated power supply for control of a LNB (Low Noise Block) or similar equipment. The supply voltage, using the drop-down dialog box, is selectable between **Off** (default), **13V** and **18V**. The output current is limited to 200 mA maximum, and is foldback limited to a low value in the event of an overload.

LNB 22kHz Tone:

A 22 kHz tone is provided for control of an LNB (Low Noise Block) or similar equipment. The tone, using the drop-down dialog box, is selectable between **Off** (default) or **On**.

Front End Lock

If full lock is acquired onto the channel and it is receiving the signal correctly, the **Front End Lock** (FEL) indicator will light up green. When a signal is present but no lock is achieved, the indicator is red. When no signal is found, the indicator is gray.

BER

The Bit Error Rate ahead of the FEC is displayed.

Input Card Screen - 8PSK

The following LES indicators are available in the Readings section of the screen:

- RF Lock** Indicates when the RF receiver sections are in lock and receiving normally.
- FEC Lock** Indicates when the Forward Error correction (DVB or turbo coded) is in lock and the data is being processed to give Transport Streams.

The following graphs are available when the 8PSK interface card is installed:

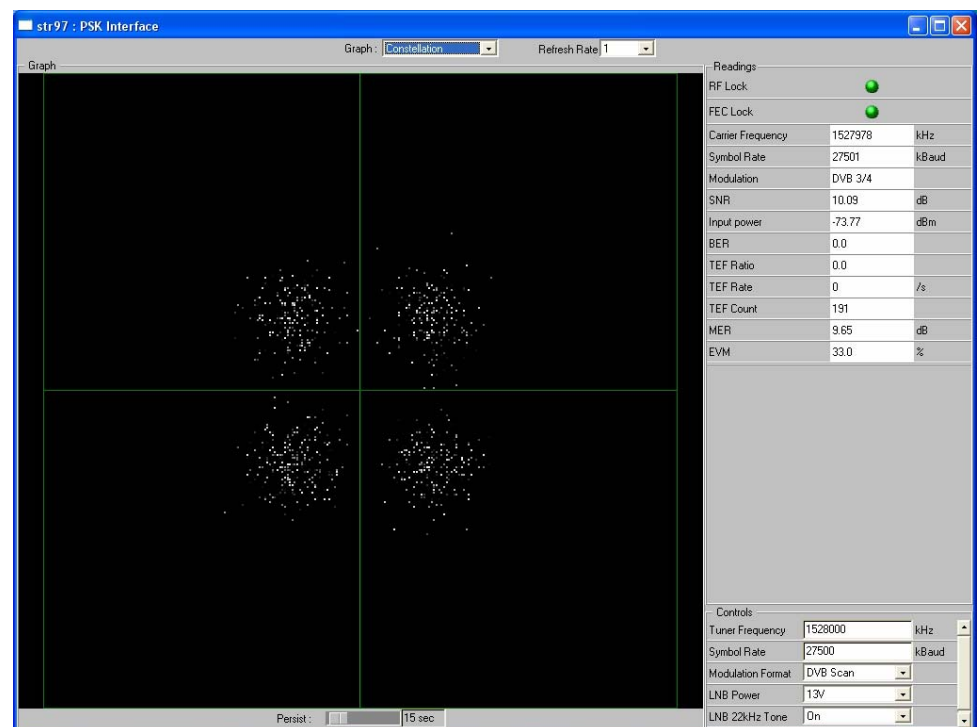

Figure 3-49: Input card screen (example - 8PSK)

- Constellation** I and Q data are collected from the QAM front end and displayed as a conventional constellation of 256 points by 256 points. The samples collected are not real time, so there is some dwell (delay) before a complete constellation is displayed. The persistence of the display can be varied using the Persist slider control at the bottom of the graph.

MER and EVM calculations are performed on the constellation data according to the formulas given in ETR290-101

SMPTE310 Settings

There are no user settings associated with the SMPTE (Society of Motion Picture and Television Engineers) interface.

(Refer to the *MTM400 MPEG Transport Stream Monitor Technical Reference* for more details about the SMPTE interface.)

ASI Settings

There are no user settings associated with the ASI (Asynchronous Serial Interface) interface.

(Refer to the *MTM400 MPEG Transport Stream Monitor Technical Reference* for more details about the ASI interface.)



Appendices

Appendix A: Network Installation

A major feature of the MTM400 MPEG Transport Stream Monitor is its versatility with respect to configuration. Although always operating within a client-server architecture, the following configuration options are available:

- The MTM400 can be left unattended. In this setup, the front panel LEDs and any configured external alarms will indicate monitoring test failures.
- The MTM400 can be monitored from a PC over an Ethernet or the Internet using the Web Monitoring Systems Manager (WebMSM), Multi-Layer Monitor (MLM1000) or the Remote User Interface (RUI).

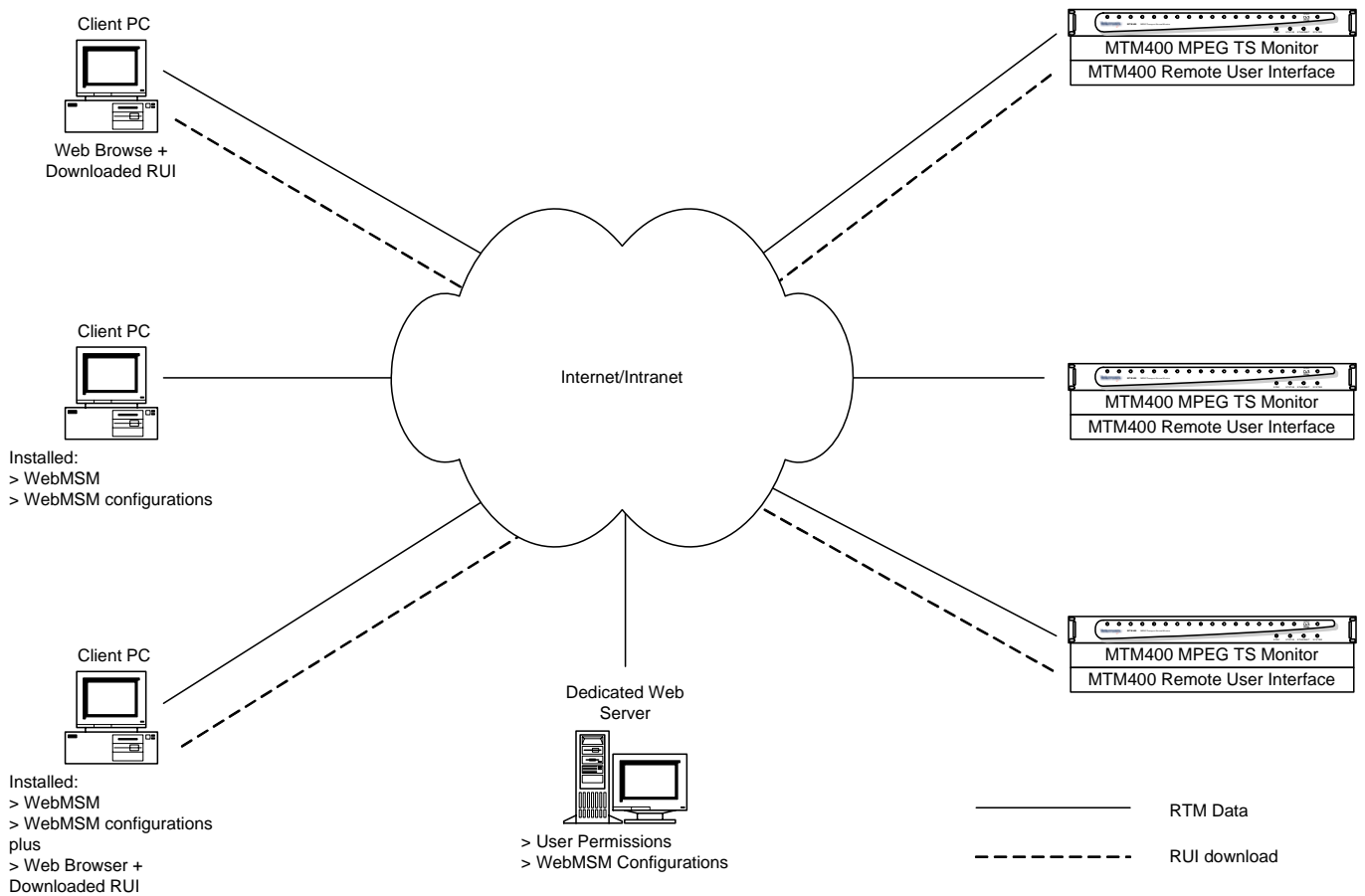

Figure A-1: Network set-up - Example

- The WebMSM software is installed on a client PC and allows the user to monitor and control the MTM400. The WebMSM can be used to monitor all compatible devices on a network (if the appropriate license is held).
- The Remote User Interface (RUI) software, based on the WebMSM, is downloaded and accessed from the MTM400 using a browser (Microsoft Internet Explorer with Microsoft Virtual Machine installed) of any networked personal computer.

The provided HTML file allows you to open the RUI by typing in the URL `http://<IP address>` or network identity on a Web Browser on a client PC. The user permissions are set up to allow an Administrator to have read-write permissions and a User to have read-only permissions.

When logging in, the default password for the Administrator is 'tek'; by default, the User does not require a password.

Before proceeding, ensure that the following information is available:

- MTM400 MAC address: `xx-xx-xx-xx-xx-xx`
 - Location 1: rear panel
 - Location 2: main circuit board (internal)
 - Location 3: instrument top cover (optional)
 - MTM400 IP address: `yyy.yyy.yyy.Yyy`
 - Assigned by network administrator
 - MTM400 software license: `zzzz-zzzz-zzzz-zzzz`
 - Location 1: instrument top cover (optional)
-

MAC Address

The Transport Stream Processor board in the MTM400 unit is assigned a unique MAC (Media Access Control) address; this is also used as the unique address of the complete unit. The MAC address is printed on labels attached to the Processor card and the unit.

The MAC address is written as six pairs of hex digits separated by hyphens, for example, '00-01-F8-A7-33-CC'.

The MAC address must be associated with an IP address for the unit to be able to function within a network.

IP Address

An IP address is assigned to each unit and acts as a unique identifier within a network. An IP address will be assigned by the Network Administrator.

IP addresses are written as four groups of up to three digits each separated by periods, for example, '119.183.115.11'.

The IP address must be associated with a MAC address for the unit to be able to function within a network.

New units are shipped with the IP address set to 0.0.0.0; this is because the IP address that will be used by a customer is unknown. In this situation, the steps described below must be followed in order to associate the proper IP address with the MAC address (see *Network Set-Up*, page A-7).

If the IP address is not known, it must be reset to 0.0.0.0 and set up with a new IP address before the unit can be used.

Resetting the IP Address

There are two ways of resetting the IP address of an MTM400 unit to '0.0.0.0' (factory default).

Method 1: If the current IP address of the unit is known, the address can be reset using the MTM400 user interface.

Method 2: If the current IP address of the unit is unknown, the address must be reset by clearing the non-volatile RAM on the Transport Stream Processor board. Clearing the RAM resets all configuration data, including the IP address and the option license, to the factory defaults.

Resetting the IP Address using the User Interface

With the unit powered up and connected to the network in which its current IP address is recognized:

1. Open the user interface, logging on as Administrator.
2. From the Device view Configuration dialog, select **Network Settings....**

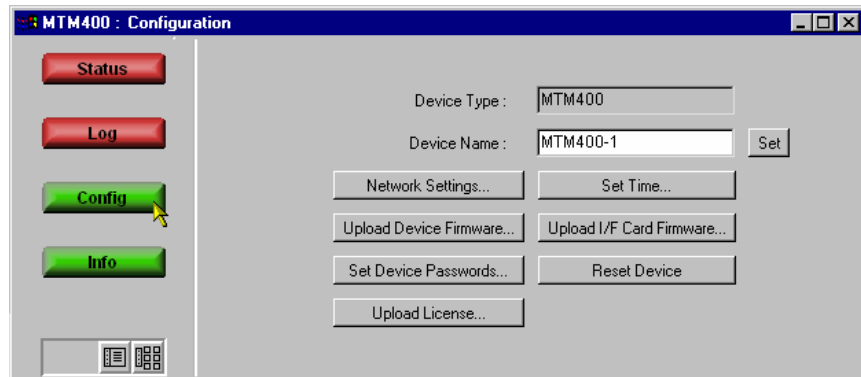

The **Network Settings** dialog box is displayed.

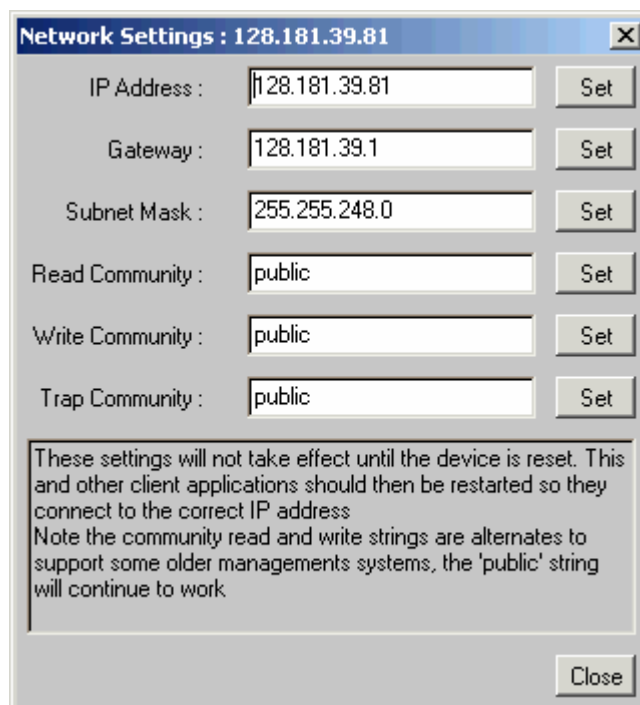

3. When the values have been changed as required, select the adjacent **Set** button to store the new settings in the MTM400.

If necessary, obtain the Gateway and Subnet Mask values from the Network Administrator.

4. When the settings have been changed and set and **Close** is selected, the following dialog is displayed:

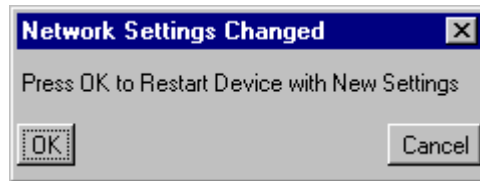

Select **OK** to restart the device and for the settings to take effect. Select **Cancel** if a restart is not required (the settings will take effect the next time that the unit is restarted).

The unit will be restarted, but the current network will not be able to communicate with it. At this point the unit must be disconnected and moved to its new location. If the new IP address was correctly entered, it should be immediately available on the new network. However, if the new network is unable to communicate with the new unit, you may need to reset the unit and reenter the new IP address, as described below.

Resetting the IP Address to Factory Default

An existing IP address can be reset to the factory default ('0.0.0.0') by resetting the battery-backed non-volatile RAM on the Transport Stream Processor board. Clearing the RAM resets all configuration data, including the IP address, to the factory defaults.

NOTE. *Another consequence of clearing the non-volatile RAM is the loss of the licensing information; the license key must be reentered after setting the IP address.*

Removing the Cover

The unit cover is held in position by 21 x T10 Torx screws.

1. Remove and retain the 21 cover retaining screws.
2. Lift the cover from the unit.

Resetting the Non-Volatile RAM

- Locate and press the Non-Volatile RAM Reset switch (SW111). This action resets the non-volatile RAM and clears the current configuration. As part of this action, the IP address is reset to 0.0.0.0.

NOTE. Another consequence of clearing the non-volatile RAM is the loss of the licensing information; the license key must be reentered after setting the IP address.

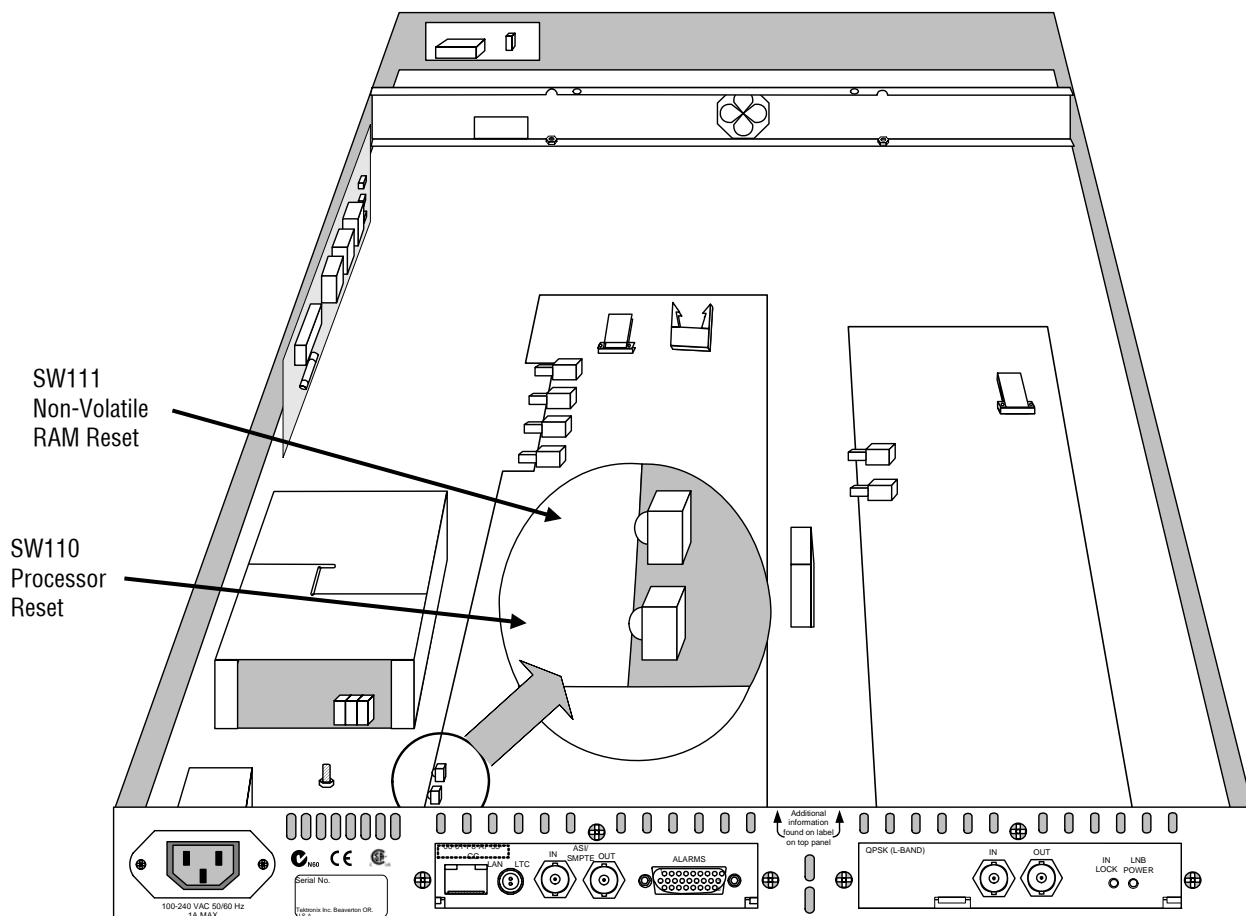

Figure A-2: Transport stream processor reset switches

Replacing the Cover

1. Before replacing the cover, ensure that all components are in place and that all connections are secure.
2. Replace the 21 cover retaining screws and ensure that they are uniformly tightened.

Proceed with setting up the required IP address.

Network Set-Up

Setting up requires MS DOS on a client PC, with both the MTM400 and the client PC powered up and attached to the same Ethernet network. They should also be attached to the same subnet, if present.

Setting Up a Static ARP Entry

Associating the MAC address with the IP address involves making an entry in the ARP (Address Resolution Protocol) table. This is done as follows:

1. On the client PC, open a MS-DOS window (**Start → Programs → Command Prompt**).
2. Enter: `C:\> ARP -s <IP address> <Ethernet MAC address>`
for example, `C:\> ARP -s 192.158.201.19 00-01-F8-A7-33-CC`
3. If the command is successful, the prompt is redisplayed with no message.

Testing the IP Address

- On the client PC, in the MS-DOS window, enter:
`C:\> ping <IP address>`
for example, `C:\> ping 192.158.201.19`

The response should take the following form:

```
Pinging 192.158.201.19 with 32 bytes of data:

Reply from 192.158.201.19: bytes=32 time<10ms TTL=128
Reply from 192.158.201.19: bytes=32 time<10ms TTL=128
Reply from 192.158.201.19: bytes=32 time<10ms TTL=128
Reply from 192.158.201.19: bytes=32 time<10ms TTL=128
```

The IP set-up is now complete. Close the MS-DOS window. With the IP Address successfully set up, the network settings can be completed (refer to *Resetting the IP Address using the User Interface*, page A-4).

The ARP command cannot be used if the unit already has an IP address - it will only work if the IP is 0.0.0.0. (Refer to *Resetting the IP Address to Factory Default*, page A-5 if the IP address is to be reset.)

Network Naming

If the MTM400 is to be accessible by network name rather than IP address, the relationship between the IP address and the network name will need to be set up on a DNS (domain name server) server on the network. This is not the name set up in the Configuration screen. Contact your Network Administrator for help.

When the IP address has been set up, if the MTM400 is to be accessed from a different net or subnet, the Gateway IP address and the Subnet Mask must be set up. Contact your Network Administrator for help. The Gateway IP address and the Subnet Mask values are set up in the **Device Configuration → Network Settings...** dialog. The MTM400 must be restarted in order for the settings to take effect.

Network Latency

It has been noted that where access to a remote MTM400 uses a number of internet/intranet links of varying speeds, the initial RUI download may be initiated successfully, but the process then ceases. The network speed is outside of the control of Tektronix, but it may be possible to alter some of the local network settings to alleviate the problem.

Appendix B: Maintenance

This appendix describes some general care and service procedures for the MTM400 MPEG Transport Stream Monitor and includes the following subsections:

- *Preventive Maintenance* provides cleaning instructions.
- *Rack Mounting* provides instructions for installing the unit in a 19-inch equipment rack.

Preventative Maintenance

Protect the unit from adverse weather conditions. The unit is not waterproof.



CAUTION. *To avoid damage to the unit, do not expose it to sprays, liquids or solvents.*

Do not use chemical cleaning agents; they may damage the instrument. Avoid chemicals that contain benzene, toluene, xylene, acetone or similar solvents.

Preventive maintenance mainly consists of periodic cleaning. The unit should be cleaned as needed based on the operating environment.

Cleaning the Exterior

Clean the exterior surfaces of the instrument with a dry, lint-free cloth or a soft-bristle brush. If dirt remains, use a cloth or swab dampened with a 75% isopropyl alcohol solution. A swab is useful for cleaning in narrow spaces around the connectors. Do not use abrasive compounds on any part of the unit.



CAUTION. *Avoid getting moisture inside the unit during external cleaning. Use only enough cleaning solution to dampen the cloth or swab. Use a 75% isopropyl alcohol solution as a cleanser. To rinse, repeat the same process using a cloth dampened with de-ionized water.*

Rack Mounting



CAUTION. *Efficient cooling will be maintained in a rack-mounted unit if the air temperature at all intake air vents (inside the rack) does not exceed 40 °C.*



WARNING. *To avoid fire hazard, the MTM400 must be installed in the rack only as specified, and proper ventilation must be maintained.*

The MTM400 can be mounted in a standard 19-inch equipment rack.

The chassis components of the rack slides are attached during manufacture as shown in Figure B-1:

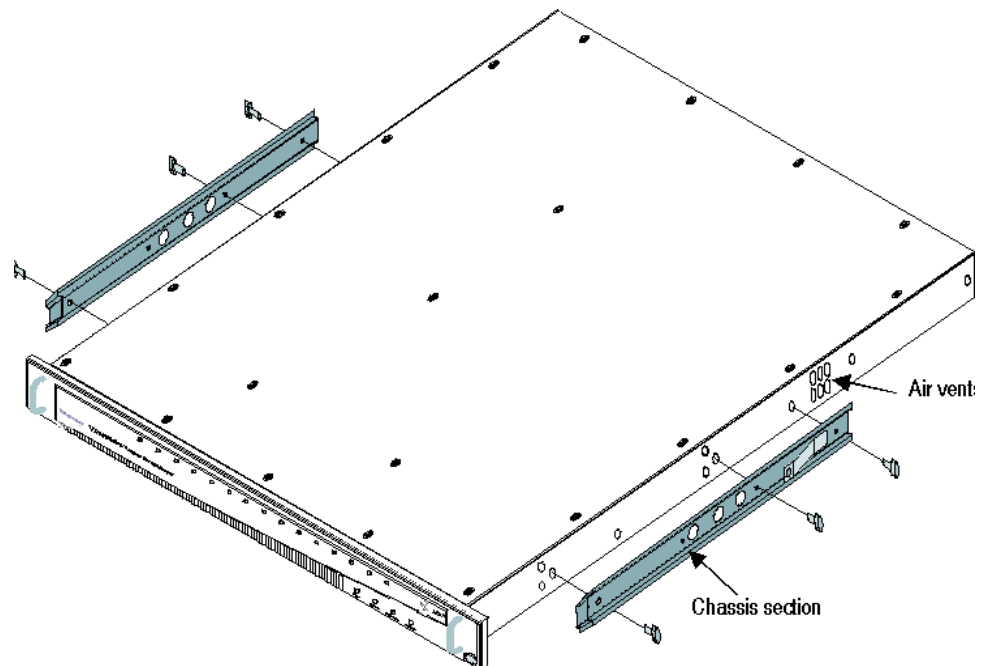

Figure B-1: Chassis section rack slides



CAUTION. *If the right slide is replaced for any reason, it must not obstruct the adjacent air vents.*

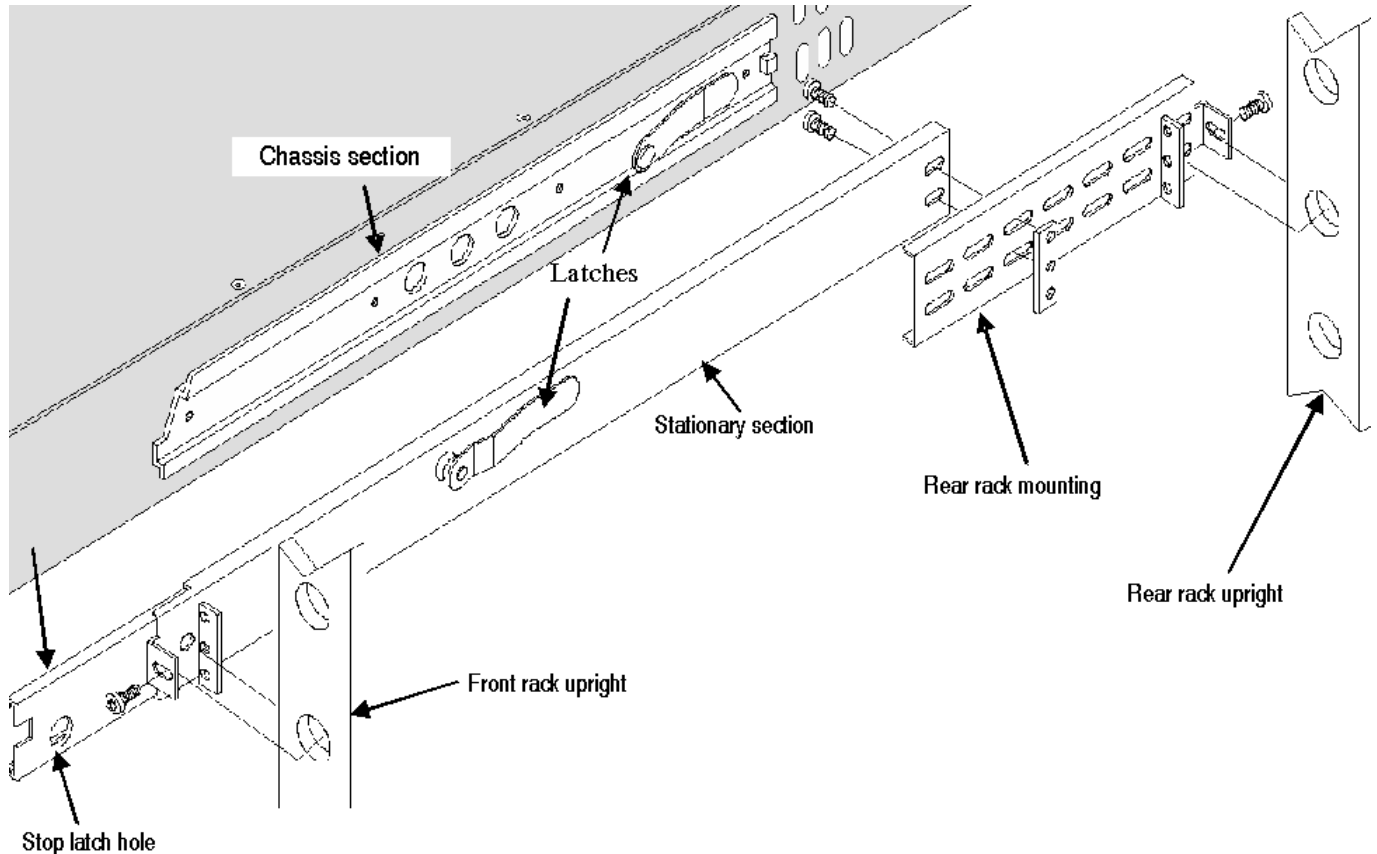

Figure B-2: Rack mounted sections

The chassis section is already installed on the unit. The position of the rear rack mounting can be adjusted to suit the depth of the rack. Approximately six inches of clearance is required between the rear panel of the unit and any rear cabinet panel to allow for connector space and adequate air circulation.

Installing the MTM400 Unit

Refer to Figure B-3 to install the unit in the rack.

1. Pull the slide-out track section to the fully extended position.
2. Insert the MTM400 chassis sections into the slide-out sections.
3. Press the stop latches and push the unit toward the rack until the latches snap into their holes.
4. Press the stop latches again and push the unit fully into the rack.
5. Tighten the front panel retaining screw.

Removing the MTM400 Unit

Refer to Figure B-3 to remove the unit from the rack.

1. Loosen the front panel retaining screw and pull the unit out until the stop latches snap into the holes.
2. Press the stop latches and remove the unit.

When removing the unit from the rack, be sure to disconnect all cabling.

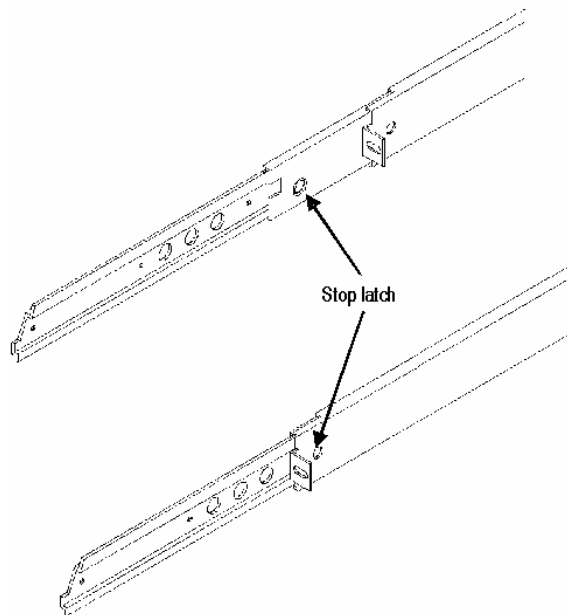

Figure B-3: Installing or removing the rack slides

Rack Adjustments

After installation, if the slide tracks are not properly adjusted, they may bind. To adjust the tracks, slide the instrument out about 10 inches, slightly loosen the screws holding the tracks to the front rails, and allow the tracks to seek an unbound position. Retighten the screws and check the tracks for smooth operation by sliding the instrument in and out of the rack several times.

Once the instrument is in place within the rack, tighten the knurled retaining screw to fasten it securely into the rack.

Rack Slide Maintenance

The slide-out tracks do not require lubrication. The dark gray finish on the tracks is a permanent, lubricated coating.



Glossary

Glossary

Program and Service: In this manual the terms program and service are interchangeable.

ARIB	Association of Radio Industries and Businesses
ASI	Asynchronous Serial Interface
ATSC	Advanced Television Systems Committee
BAT	Bouquet Association Table
BER	Bit Error Rate
CAT	Conditional Access Table
CRC	Cyclic Redundancy Check
CSV	Comma Separated Values
CVCT	Cable Virtual Channel Table
DNS	Domain Name Server
DVB	Digital Video Broadcasting
EIT	Event Information Table
EMM	Entitlement Management Message
ETT	Extended Text Table
EVM	Error Vector Magnitude
GMT	Greenwich Meantime
GPSI	General Purpose Serial Interface
IIP	ISDB-T Information Packet
ISA	Integrated Systems Architecture
ISDB	Integrated Services Digital Broadcasting
LNB	Low Noise Block
MER	Modulation Error Ratio
MGT	Master Guide Table
MHEG	Multimedia and Hypermedia Experts Group
MPEG	Moving Picture Experts Group

NIT	Network Information Table
PAT	Program Association Table
PCI	Peripheral Component Interconnect
PCR	Program Clock Reference
PID	Packet Identifier
PMT	Program Map Table
PSIP	Program and System Information Protocol (ATSC)
PTS	Presentation Time Stamp
QAM	Quadrature Amplitude Modulation
QPSK	Quaternary Phase-Shift Keying (also known as Quadrature Phase-Shift Keying)
RRT	Rating Region Table
RTM	Real-Time Monitor
RUI	Remote User Interface
SDT	Service Description Table
SI	Service Information (DVB)
SMC	Sub Miniature Connector
SMPTE	Society of Motion Picture and Television Engineers
SNMP	Simple Network Management Protocol
SSI	Synchronous Serial Interface
STT	System Time Table
TEF	Transport Error Flag
TMCC	Transmission and Multiplexing Configuration Control (ISDB-S)
TOT	Time Offset Table
TSDT	Transport Streams Description Table
TVCT	Terrestrial Virtual Channel Table
TVRO	Television Receive Only
UTC	Coordinated Universal Time
VCT	Virtual Channel Table
VSB	Vestigial sideband
XML	Extensible Markup Language



Index

Index

8

8PSK, 3-129

8VSB, 3-126

A

alarms, 3-24, 3-28

B

bit rate

Programs screen, 3-32

bit rate limits

PID Groups screen, 3-47

PIDs screen, 3-37

Programs screen, 3-32

buttons

colors, 2-11

C

change bars

PID Groups screen, 3-46

PIDs screen, 3-37

Programs screen, 3-32

COFDM, 3-122

color coding, 2-11

Configuration

Device view, 3-6

files, 3-85

schedules, 3-91

slot, 3-85

activating, 3-86

clearing, 3-89

downloading, 3-87

storing active settings, 3-87

uploading, 3-88

Configuration screen

Configuration, 3-80

DVB Region, 3-78

Factory Default, 3-80

Interface, 3-79

Maintenance Mode, 3-80

Scheduling, 3-80

Standard, 3-77

Stream Name, 3-79

Stream view, 3-76

Template Checking, 3-79

Virtual Channel Table Mode, 3-79

Custom screen

Stream view, 3-26

D

Device view

config, 3-6

Info, 3-15

Log, 3-4

overview, 2-5, 3-1

Status, 3-2

DVB Region selection, 3-78

E

event classification, 3-27

F

Factory Default selection, 3-80

font extensions, 1-12

H

Hot Spot view

overview, 2-4

I

IIP PID, 3-79

Info

Device view, 3-15

installation

- electrical, 1-9
- hardware, 1-8
- network, 1-11

interface

- 8PSK, 3-129
- 8VSB, 3-126
- COFDM, 3-122
- configuration, 3-107
- interpretation, 3-107
- L-Band, 3-109
- QAM (Annex A), 3-114
- QAM (Annex B), 3-118
- QAM (Annex C), 3-114
- QPSK (L-Band), 3-109

Interface selection, 3-79

ISDB font extensions, 1-12

ISDB-T Information Packet, 3-79

L

L-Band, 3-109

LED

- ETHERNET, 2-2
- STATUS, 2-2
- SYNC, 2-2
- SYSTEM, 2-2

Log

- Device view, 3-4

Log screen

- clear, 3-74
- log entry highlights, 3-73
- multiple entries, 3-74
- save, 3-74
- Stream view, 3-72
- time zone, 3-75

M

Maintenance, B-1

- cleaning, B-1

Maintenance Mode selection, 3-80

MTM400

- front panel, 2-2

N

Network

- installation, A-1
- latency, A-8
- naming, A-8

P

PCR Arrival graph, 3-50

PCR Drift graph, 3-54

PCR Frequency Offset graph, 3-53

PCR Inaccuracy graph, 3-49

PCR Overall Jitter graph, 3-51

PCR screen

- common elements, 3-49
- graph
 - PCR Arrival, 3-50
 - PCR Drift, 3-54
 - PCR Frequency Offset, 3-53
 - PCR Inaccuracy, 3-49
 - PCR Overall Jitter, 3-51
 - PTS Arrival, 3-55
- Stream view, 3-48

PID Group

- add, 3-43
- edit, 3-46

PID Groups screen

- bit rate limits, 3-47
- change bars, 3-46
- Stream view, 3-41

PIDs screen

- bit rate limits, 3-37
- change bars, 3-37
- Stream view, 3-34

PMT test, 3-33

powering up, 1-13

Programs screen

- bit rate limits, 3-32
- change bars, 3-32
- PMT test, 3-33
- Stream view, 3-30
- test selection, 3-40
- User PIDs, 3-38

Programs screen view

bit rate, 3-32

PTS Arrival graph, 3-55

Q

QAM (Annex A), 3-114

QAM (Annex B), 3-118

QAM (Annex C), 3-114

QPSK (L-Band), 3-109

R

Rack mounting and adjustment, B-2

RAM

reset, A-6

Raw Bytes view, 3-67

Recording, 3-99

relays, 3-25

Remote User Interface, 1-14

close, 2-3, 3-2

logging on, 1-14

overview, 2-3

S

Schedules, 3-91

downloading, 3-95

enabling, 3-95

Time Zones, 3-96

uploading, 3-94

Scheduling, 3-80

Section Repetition Interval graph, 3-59

Service Logging, 3-80

SFN screen

Stream view, 3-56

SI Graphs screen

Section Repetition Interval, 3-59

Stream view, 3-58

Subtable Inter Section Gap, 3-59

Subtable Repetition Interval, 3-59

SI Tables screen

Raw Bytes view, 3-67

selection, 3-63

Stream view, 3-62

update, 3-62

SNMP

traps, 3-3, 3-24

Standard, 3-77

Status

Device view, 3-2

Stream Name selection, 3-79

Stream view

Configuration screen, 3-76

Custom screen, 3-26

Log screen, 3-72

overview, 2-6

PCR screen, 3-48

PID Groups screen, 3-41

PIDs screen, 3-34

Programs screen, 3-30

SFN screen, 3-56

SI Graphs screen, 3-58

SI Tables screen, 3-62

Template screen, 3-68

Tests screen, 3-23

TMCC screen, 3-57

Stream View, 3-17

Subtable Inter Section Gap graph, 3-59

Subtable Repetition Interval graph, 3-59

T

Template Checking selection, 3-79

Template screen

Stream view, 3-68

Test Parameters, *See* Appendix E

overview, 3-25

test selection

Programs screen, 3-40

Tests screen

Stream view, 3-23

time zones

overview, 2-13

TMCC screen

Stream view, 3-57

Triggered Recording, 3-99

- operation, 3-103
- pre-trigger, 3-102
- set, 3-25
- set up, 3-100

TTL output, 3-24

U

User PIDs

- add, 3-39
- delete, 3-39
- Programs screen, 3-38

V

version

- user interface display, 2-12

view

- combined, 2-9
- multiple, 2-10

Virtual Channel Table Mode selection, 3-79

W

WebMSM, *See* WebMSM User Manual 071-1239-xx

- overview, 2-12