

EUREKA

Cordless, Rechargeable VACUUM CLEANER

Household Type

Owner's Guide Model 178A

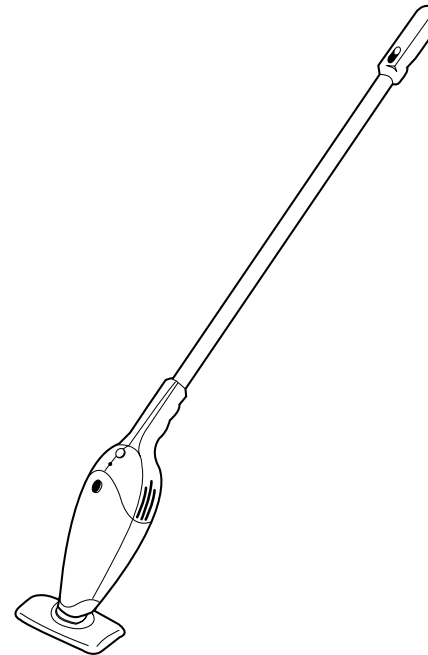

Charge 14-16 hours
before first use.

IMPORTANT

Do **not** return this
product to the store.

**For assembly problems or
questions contact:** Eureka's
Customer Service Division
toll free at 1-800-282-2886*, 7
a.m. to 8 p.m., Central Standard
Time, Monday through Saturday.

**For replacement of broken or
missing items** to be shipped
direct to you, call 1-800-438-
7352*, 8 a.m. to 4:45 p.m.,
Central Standard Time, Monday
through Friday.

***En Mexico llame 254 23 52.**

Index

| | |
|----------------------------|-------|
| Important Safeguards | 2 |
| Service Information | 4 |
| Assembly | 5 |
| Use | 7 |
| Dust Cup | 8 |
| Motor Filter | 9 |
| Battery Disposal | 9 |
| Customer Order Form | 11 |
| Warranty | 13-14 |

**For location of nearest
Eureka Warranty Station
or Service Information,
call 1-800-282-2886.**

IMPORTANT SAFEGUARDS

When using an electric appliance, basic precautions should always be followed, including the following:

READ ALL INSTRUCTIONS BEFORE USING THIS VACUUM CLEANER.

WARNING

To reduce the risk of fire, electric shock, or injury:

- Do not use outdoors or on wet surfaces.
- Do not operate the vacuum cleaner or charger that has been damaged in any way. If vacuum cleaner is not working as it should, has been dropped, damaged, left outdoors, or dropped into water, return it to a service center.
- To avoid excessive heat and damage to the unit or batteries, do not operate the vacuum cleaner while in the charging stand.
- Do not allow to be used as a toy. Close attention is necessary when used by or near children.
- Use only as described in this manual.
- Use only the charger provided to recharge; Eureka model AD-0920-UOE/EK for 120 volt.
- Do not pull or carry the charger by cord, use cord as a handle, close a door on cord, or pull cord around sharp edges or corners. Keep cord away from heated surfaces.
- Do not use extension cords or outlets with inadequate current carrying capacity.
- Do not unplug by pulling on cord. To unplug, grasp the charger, not the cord.
- Do not handle charger or vacuum cleaner with wet hands.
- **DO NOT MUTILATE OR INCINERATE BATTERIES AS THEY WILL EXPLODE AT HIGH TEMPERATURES.**
- Leaks from battery cells can occur under extreme usage or temperature conditions. If the liquid gets on the skin (1) wash quickly with soap and water or (2) neutralize with a mild acid such as lemon juice or vinegar. If the liquid gets into the eyes, flush them immediately with clean water for a minimum of 10 minutes. Seek medical attention.
- The terminal on the vacuum cleaner should be kept free and clean of objects. While there is no shock hazard from the terminal, a burn could occur if metal objects are inserted into the terminal area.
- This vacuum cleaner creates suction. Keep hair, loose clothing, fingers, and all parts of body away from openings and moving parts.
- Do not pick up anything that is burning or smoking, such as cigarettes, matches, or hot ashes.
- Do not use without a filter in place. When servicing the unit, never put fingers or other objects into the fan chamber in case the unit would accidentally be turned on.
- Use extra care when cleaning on stairs.
- Do not use to pick up flammable or combustible liquids such as gasoline, or use in areas where they may be present.
- Locate the wall bracket indoors in a cool, dry area not exposed to the weather to avoid electrical shock and/or cleaner damage.
- Keep your work area well lighted.
- Unplug electrical appliances before vacuuming them.

SAVE THESE INSTRUCTIONS

Further Limitations and Exclusions

Any warranty that may be implied in connection with your purchase or use of the cleaner, including any warranty of Merchantability or any warranty for Fitness For A Particular Purpose is limited to the duration of this warranty. Some states do not allow limitations on how long an implied warranty lasts, so the above limitations may not apply to you.

Your relief for the breach of this warranty is limited to the relief expressly provided above. In no event shall Eureka be liable for any consequential or incidental damages you may incur in connection with your purchase or use of the cleaner. Some states do not allow the exclusion or limitation of incidental or consequential damages, so the above limitation or exclusion may not apply to you.

This warranty gives you specific legal rights. You may also have other rights which vary by state.



Questions & Answers about Genuine Eureka Products

Q: Why should I use only Genuine Eureka parts in my Eureka product?

A: Using Genuine Eureka Products, which are made to our exacting specifications and engineered with emphasis on quality, performance, and customer satisfaction, ensures the long life and cleaning efficiency of your vacuum cleaner. Overall, this saves you money and helps to keep your home clean.

Q: How can I be sure I am using only genuine Eureka products in my product?

A: Typically, packaged products and paper bags can be identified by a "Genuine Eureka Product" symbol (see illustration above). For further identification assistance, you may call our toll-free number, 1-800-282-2886, for the location of a nearby Eureka Authorized Warranty Station.

Q: Are there any differences between "made to fit" or "imitation" and Genuine Eureka parts?

A: Yes, there are some very important differences in materials, quality, and reliability. Many customers have mistakenly purchased "imitation" paper bags and parts while thinking they purchased genuine. Unfortunately, many of these customers discovered the differences after they experienced related difficulties.

Household Warranty
abs 190

For Genuine Eureka Value, Accept No Limitations!

THE EUREKA COMPANY

Bloomington, Illinois 61701

CONSEILS DE SÉCURITÉ

Lors de l'utilisation d'un appareil électrique, quelques précautions élémentaires doivent être observées, incluant les suivantes:

LISEZ TOUTES LES INSTRUCTIONS AVANT D'UTILISER VOTRE ASPIRATEUR.

AVERTISSEMENT

Pour réduire le risque de feu, de choc électrique ou de blessure:

- N'utilisez pas l'aspirateur à l'extérieur ou sur une surface mouillée.
- N'utilisez jamais l'aspirateur ou le chargeur s'ils ont été endommagés. Si l'aspirateur ne fonctionne pas comme il le faut, s'il a été échappé, s'il a été endommagé, s'il a été laissé à l'extérieur, s'il a été échappé dans de l'eau, retournez-le à un centre de service avant de l'utiliser.
- Pour éviter que l'aspirateur surchauffe, ou que l'aspirateur ou les piles soient endommagés, n'utilisez pas l'aspirateur lorsqu'il est encore dans son support de recharge.
- Ne permettez pas que l'aspirateur soit utilisé comme un jouet. Une attention particulière est nécessaire lorsqu'il est utilisé par ou près d'un enfant.
- Suivez les recommandations d'utilisation de ce manuel.
- Pour recharger l'aspirateur, utilisez uniquement le chargeur qui l'accompagne – Eureka modèle n° AD-0920-UOE/EK pour 120 volt.
- Ne pas tirer l'aspirateur ou le transporter par le cordon. Ne pas utiliser le cordon en guise de poignée. Ne pas fermer une porte sur le cordon ou tirer le cordon sur des bordures ou des coins pointus. Tenir le cordon à distance des surfaces chauffantes.
- Ne pas utiliser des rallonges ou des prises qui n'ont pas une capacité suffisante pour transporter le courant.
- Ne pas débrancher en tirant sur le cordon. Pour débrancher, empoignez le chargeur et non pas le cordon.
- Ne pas manipuler le chargeur ou l'aspirateur avec les mains mouillées.
- **NE PAS MUTILER OU INCINERER LES PILES. LES PILES EXPLOSENT A DES TEMPERATURES EXCESSIVES.**
- Il peut y avoir des fuites des éléments des piles lorsque celles-ci sont soumises à des conditions d'emploi excessif ou de température excessive. Si le liquide touche la peau (1) laver tout de suite la peau avec de l'eau et du savon (2) Neutraliser avec un acide doux, tel que le jus de citron ou le vinaigre. Au cas de contact avec les yeux, nettoyer à grande eau pour un minimum de 10 minutes. Cherchez des soins médicaux.
- La borne de l'aspirateur doit être maintenue propre et libre de tout autre objet. Il n'y a aucun risque de choc électrique de la borne elle-même, mais une brûlure est possible si des objets en métal sont introduits dans la borne.
- Cet aspirateur crée de la succion. Tenir les parties mobiles et les ouvertures loin des cheveux, des habits, des doigts et de toute partie du corps.
- Ne pas ramasser des objets qui brûlent ou fument comme des cigarettes, des allumettes ou les cendres chaudes.
- Ne pas utiliser sans que le filtre ne soit installé. Lors de réparations ou d'entretien, il ne faut jamais mettre les doigts, ou autres objets, près du ventilateur dans le cas où l'aspirateur serait accidentalement mis en marche.
- Portez une attention particulière lorsque vous nettoyez les escaliers.
- Ne pas utiliser pour ramasser des liquides inflammables ou combustibles comme de l'essence. Ne pas utiliser dans les endroits où ces liquides pourraient être présents.
- Situez le support pour l'aspirateur à l'intérieur, dans un endroit frais, sec et protégé pour éviter le choc électrique ou les dommages.
- Travaillez toujours dans un endroit bien éclairé.
- Débranchez les appareils électriques avant de les nettoyer avec l'aspirateur.

CONSERVEZ CES INSTRUCTIONS

GENERAL INFORMATION

The cordless vacuum cleaner is the answer for quick, convenient, and easy cleanups. Grab the cleaner for little tasks rather than using a larger cleaner. Place the wall bracket in any area of easy access that allows versatile cleaning of kitchen crumbs, window sills, or steps. Always store the cleaner in the wall bracket to provide a ready charge.

Charge for 14-16 hours before first use.
Batteries could lose charge in shipping.

It is best to charge the batteries when temperatures are between 32°F (0°C) and 104°F (40°C). Other temperatures could damage batteries.

While charging, the charger may become warm to the touch. This is a normal condition and does not indicate a problem.

Service Information

The instructions in this booklet serve as a guide to routine maintenance. If additional service is required, telephone toll free:

USA: 1-800-282-2886
Mexico: 254 23 52
Canada: 1-800-282-2886

for the nearest Eureka Authorized Warranty Station. If you prefer, you can write to THE EUREKA COMPANY, Service Division, 1201 E. Bell Street, Bloomington, IL 61701, USA. In Canada write to THE EUREKA COMPANY, 866 Langs Drive, Cambridge, Ontario N3H 2N7. Refer to The Eureka Warranty for complete service information.



DO NOT OIL. The motor has lubrication and has a permanent seal.

Rating Plate

The model number is indicated on the rating plate which is located on the underside of the vacuum cleaner. For prompt and complete service, always refer to these numbers.

Model and Type No. _____

Serial No. or Date Code _____

THE EUREKA COMPANY
Bloomington, Illinois 61701 USA
HOUSEHOLD TYPE
MODEL

THE EUREKA LIMITED WARRANTY

What This Warranty Covers

Your Eureka cleaner is warranted to be free from all defects in material and workmanship in normal household use for a period of one year. The warranty is granted only to the original purchaser and members of his or her immediate household. The warranty is subject to the following provisions.

What This Warranty Does Not Cover

- Parts of the cleaner that require replacement under normal use.
- Damages or malfunctions caused by negligence, abuse, or use not in accordance with the Owner's Guide.
- Defects or damages caused by unauthorized service or the use of other than Genuine Eureka parts.

What The Eureka Company Will Do

The Eureka Company will, at its option, repair or replace a defective cleaner or cleaner part that is covered by this warranty. As a matter of warranty policy, the Eureka Company will not refund the consumer's purchase price.

Warranty Registration

Please fill out and return the warranty registration card accompanying your cleaner.

Obtaining Warranty Service

To obtain warranty service you must return the defective cleaner or cleaner part along with proof of purchase to any Eureka Authorized Warranty Station. You will find the nearest location in the Yellow Pages, under "Vacuum Cleaners—Service and Repair." Be certain that the Warranty Station is "Eureka Authorized." For the location of the nearest Eureka Authorized Warranty Station or for service information, telephone toll free:

USA: 1-800-282-2886
Mexico: 254 23 52
Canada: 1-800-282-2886

If you prefer, you can write to THE EUREKA COMPANY, Service Division, 1201 E. Bell Street, Bloomington, Illinois 61701, USA. In Canada write to THE EUREKA COMPANY, 866 Langs Drive, Cambridge, Ontario N3H 2N7. If it is necessary to ship the cleaner outside your community to obtain warranty repair, you must pay the shipping charges to the Eureka Authorized Warranty Station. Return shipping charges will be paid by the Warranty Station. When returning parts for repair, please include the model, type, and serial number from the data plate on the cleaner.

Identify Parts

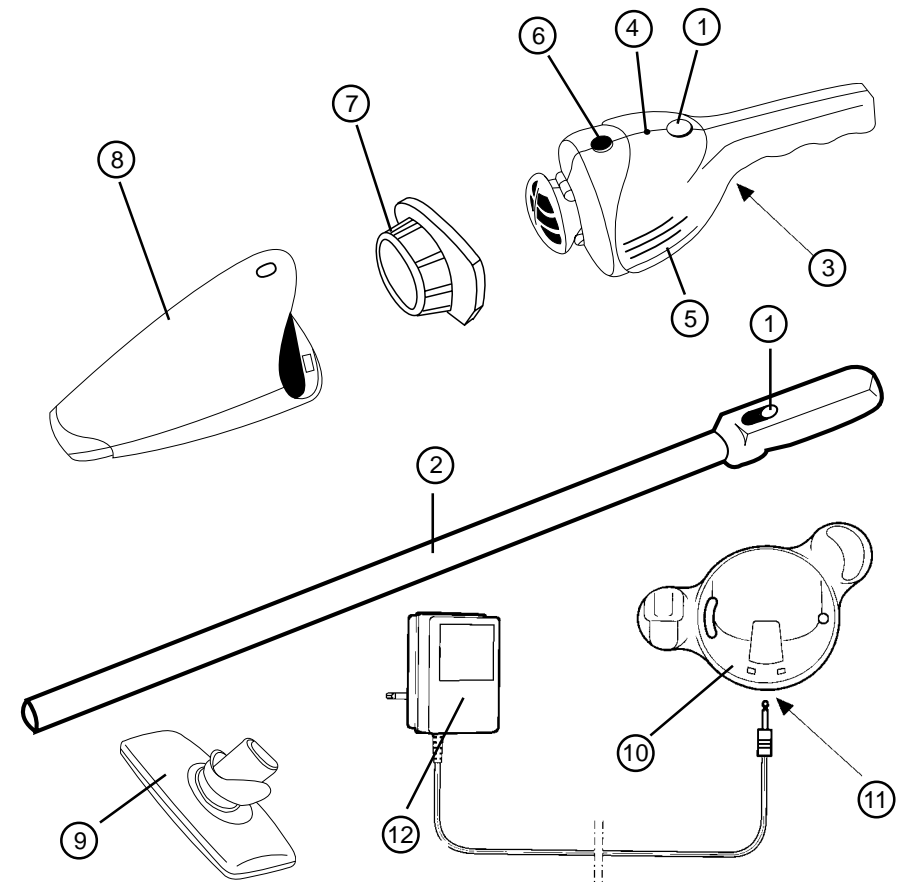

1. On/Off Switch
2. Stick Vac Handle
3. Release Button for the Stick
4. Charging Indicator Light
5. Motor Unit
6. Release Button for the Dust Container
7. Filter
8. Dust Container
9. Nozzle
10. Charging Holder
11. Connection, Charging Plug
12. Charging Unit
13. Broom Nozzle

Attach Charger Plug to Wall Bracket

CAUTION: Use only charger model AD-0920-UOE/EK for 120 volt.

Your vacuum cleaner has a special bracket designed to hold the unit, so that it may recharge while mounted on the wall.

How to Mount your Vacuum Cleaner

Cleaner hangs in bracket with the nozzle end up. Mount on a wall where there are no dangerous objects hidden beneath the wall surface like electrical wires, pipes, etc.

1. Hold bracket against wall to mark location for screws. Make sure the wall bracket is positioned vertically, with the charger socket at the bottom. See Fig. 1.
2. Use a 1/4 inch drill for drilling holes for the plastic anchors.
3. Insert the anchors and drive the screws into both holes.
4. Coil up any extra cord length and place on the back of the bracket as shown in Fig. 2.
5. Tighten the screws to secure the bracket.
6. Place cleaner, with the nozzle pointed up, on the wall bracket, Fig. 3.
7. Plug the charger into an electrical outlet.

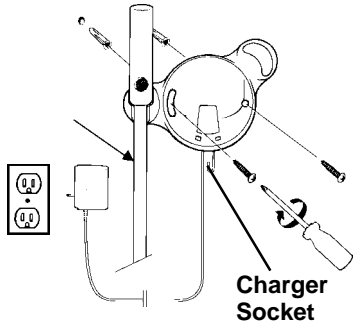

Fig. 1

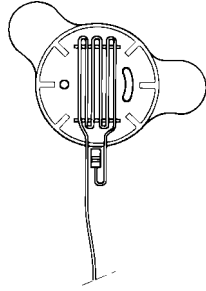

Fig. 2

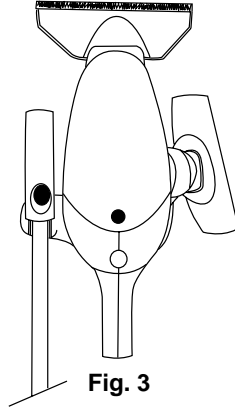

Fig. 3

NOTE: Charge the cleaner for 14-16 hours before initial use. The batteries of a new cleaner are on a low charge.

EUREKA
VACUUM CLEANERS
The Eureka Company
1201 E. Bell St.
P.O. Box 2799
Bloomington, IL 61701-2799

ORDER FORM

S O L D T O

Name _____
Address (street address needed for UPS) _____
City _____ State _____ Zip _____
Telephone (Day) _____ (Eve) _____ (Fax) _____

S H I P T O

Name _____
Address (street address needed for UPS) _____
City _____ State _____ Zip _____
Telephone (Day) _____ (Eve) _____ (Fax) _____

To Order
Vacuum Cleaner Model Number: _____
Type: _____
Serial Number: _____

By Phone
1-800-438-7352*
HOURS:
Call between 8 a.m. and 4:45 p.m. central standard time

By FAX
1-309-823-5789
To Answer Problems or Questions
1-800-282-2886*
7 a.m. to 8 p.m. central standard time Monday through Saturday

*En Mexico Llame
254 23 52

By Mail

Simply fill out this Order Form. Please be sure to include day and evening phone numbers.
www.eureka.com

| Item | Part No. | Qty. | Price | Total |
|---|----------|------|-------|---------------|
| Genuine Eureka Replacement Parts | | | | |
| Motor Filter only | 60694 | | 1.79 | |
| Floor Nozzle w/o Brush | 60780 | | 3.09 | |
| Floor Nozzle w/Brush | 60781 | | 9.19 | |
| Miscellaneous Items | | | | |
| Adapter Unit | 60695 | | 8.19 | |
| Battery | 60702 | | 25.99 | |
| Wall Bracket | 60779 | | 3.09 | |
| Total (prices subject to change without notice) | | | | |
| Tax (add state tax & local taxes as required by law) | | | | |
| Postage & Handling Charge (within U.S.A.) | | | | \$3.75 |
| TOTAL | | | | |
| TOTAL ENCLOSED | | | | |

Method of payment (no C.O.D. orders)

Check or money order (payable to The Eureka Company). Do not send currency.

Charge to my Visa (13/15 digits) MasterCard (13 digits) Amer. Express (15 digits)

Acct. number _____

Signature (full name as shown on acct.) _____

Expiration Date _____

All prices in U.S. dollars.

HOW TO USE

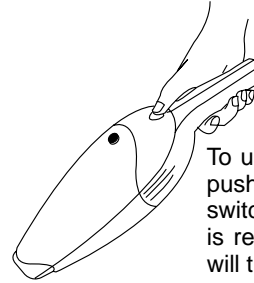

To use as a **hand vac**, push and hold the on/off switch. When the switch is released the cleaner will turn off.



To use as an **upholstery cleaner**, attach floor nozzle.

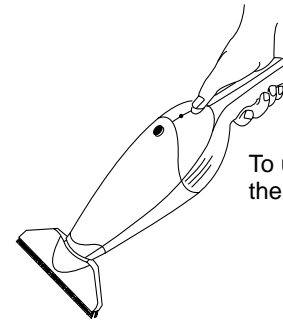

To use as a **wisk broom** attach the broom nozzle.

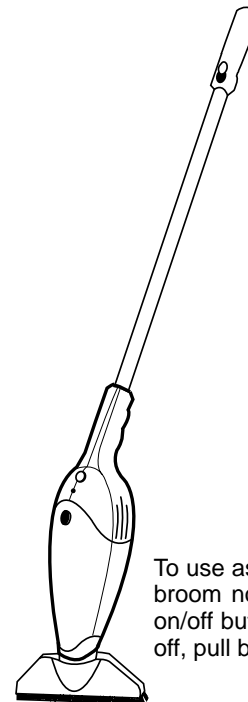

To use as an **upright sweep vac**, attach the broom nozzle. To turn cleaner on, push the on/off button on the handle forward. To shut off, pull back on the on/off button.

To use as a **stick vac**, attach the stick vac handle and floor nozzle. To turn cleaner on, push the on/off button on the handle forward. To shut off, pull back on the on/off button.

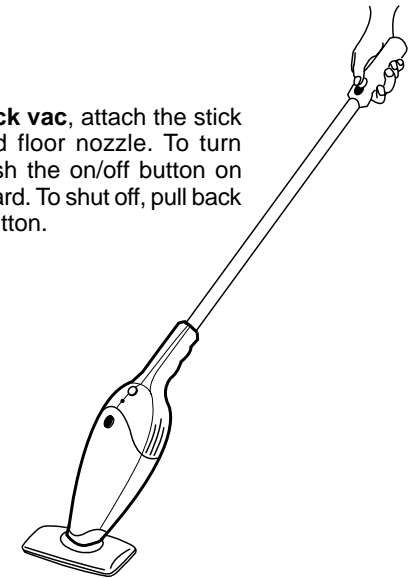

HOW TO MAINTAIN

The instructions given in this booklet serve as a guide to routine maintenance. Keep the cleaner operating at top efficiency. Empty the dust cup and clean the filter after each use.

Storing and Charging the Vacuum Cleaner

Return your vacuum cleaner to the wall holder (as shown) after every use. Firmly position into the mounting bracket ensuring that the vacuum cleaner fits correctly into the charging socket. It will then be recharged and ready for operation at all times.

The plug charger can be left in the electrical outlet at all times, even when the unit is in use. It is impossible to overcharge the batteries. The plug charger will become warm, however, this is not a cause for concern. The unit is charging when the red light on the top of the vacuum cleaner is illuminated.

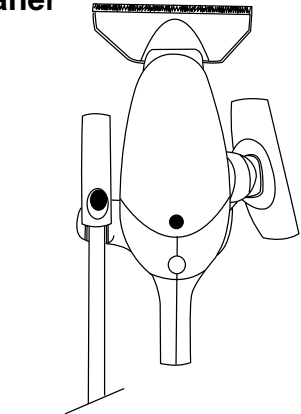

Vacuum stored in wall holder.

Empty Dust Cup

1. Push down on dust cup latch.
2. Pull dust cup from motor unit.
3. Remove motor filter from dust cup.
4. Shake contents into a waste container.
5. Clean motor filter (refer to motor filter section, page 9).
6. Replace motor filter in the dust cup.
7. Press dust cup onto handle section until they snap together.

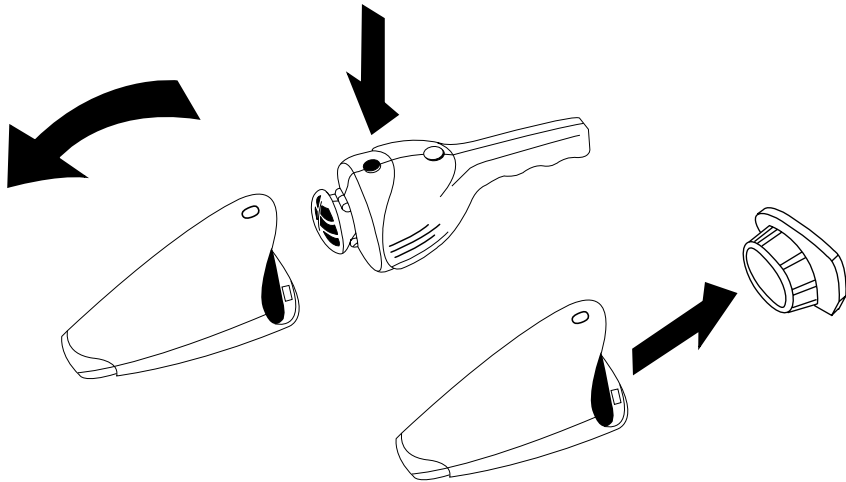

Clean Motor Filter

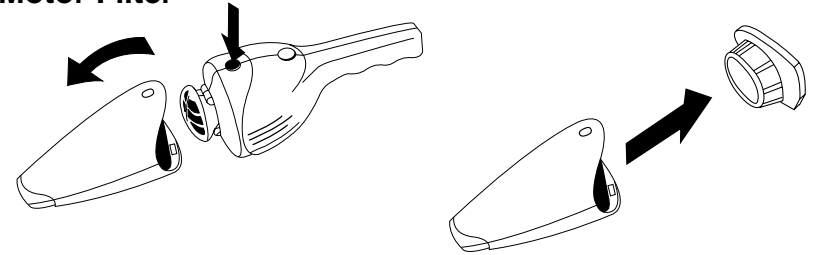

Clean the motor filter after each cleaner use.

1. Remove the filter frame from the dust cup.
2. Shake and brush the dust and dirt from filter.
3. If desired, launder the filter by hand in warm water (150°F, 65°C) using a mild detergent.
4. Air dry thoroughly.

Replace a dirty or torn filter. Order additional motor filters from The Eureka Company, Bloomington, IL 61701.

Order motor filter, part number 60694.

Remove Ni-MH Battery Pack for Disposal

NOTE: Remove the battery pack only when the batteries no longer hold a charge and you plan to dispose of them.

CAUTION: Do not short circuit or dispose of in fire. Dispose of properly.

1. Lay cleaner down on its top.
2. Grasp handle with thumb on battery cover. Using thumb push down and slide battery cover toward wrist. This will loosen the battery cover so it can be freed from the cleaner.
3. Remove battery pack and throw away.