



kitchen think

Instructions for Installation and Use

**Fridge / Freezer
Model HME40N**

To the Installer

Before installation fill in the product details on the back cover of this book.
The information can be found on the rating plate.

To the User

You must read the instructions prior to installing and using the appliance and
then retain them for future reference.

Retention of this Instruction Book

This Instruction Book must be kept handy for reference as it contains important details on the safe and proper use of the appliance.

If you sell or pass the appliance to someone else, or move house and leave it behind, make sure this Book is also provided so the new owner can become familiar with the appliance and safety warnings.

If the Book is lost or damaged a copy may be obtained from:
Indesit Company UK Ltd. Morley Way, Peterborough, PE2 9JB

Operating Instructions

REFRIGERATOR/FREEZER COMBINATION

GB

English,1

HME40N

GB

Contents

Installation, 4-5

Positioning and connection

Description of the appliance, 6-7

Control panel

Overall view

Accessories, 8

Refrigerator compartment

Freezer compartment

Display, 9-10

Display description

Using the display

Start-up and use, 11

Starting the appliance

Using the refrigerator to its full potential

Using the freezer to its full potential

Maintenance and care, 12

Switching the appliance off

Cleaning the appliance

Avoiding mould and unpleasant odours

Defrosting

Replacing the light bulb

Precautions and tips, 13

General safety

Disposal

Respecting and conserving the environment

Troubleshooting, 14

Assistance, 15

After Sales Service, 18

Hotpoint Guarantee, 19

Key Contacts, 20

Installation

GB

! Before operating your new appliance, please read these operating instructions carefully. They contain important information for safe use, installation and care of the appliance.

! Please keep these operating instructions for future reference. Pass them on to possible new owners of the appliance.

Positioning and connection

Positioning

1. Place the appliance in a well-ventilated humidity-free room.
2. Do not obstruct the rear fan grills. The compressor and condenser give off heat and require good ventilation to operate correctly and save energy.
3. Leave a space of at least 10 cm between the top part of the appliance and any furniture above it, and at least 5 cm between the sides and any furniture/side walls.
4. Ensure the appliance is far away from any sources of heat (direct sunlight, electric stove, etc.).

Levelling

1. Install the appliance on a level and rigid floor.
2. If the floor is not perfectly horizontal, adjust the refrigerator by tightening or loosening the rear feet.

Electrical connections

After transportation of the appliance, carefully place it vertically and wait at least 3 hours before connecting it to the electricity mains. Before inserting the plug into the electrical socket ensure the following:

- The appliance is earthed and the plug is compliant with the law.
- The socket can withstand the maximum power of the appliance, which is indicated on the data plate located on the bottom left side of the fridge (e.g. 150 W).
- The voltage must be in the range between the values indicated on the data plate located on the bottom left side (e.g. 220-240V).
- The socket is compatible with the plug of the appliance.

If the socket is incompatible with the plug, ask an authorised technician to replace it (*see Assistance*). Do not use extension cords or multiple sockets.

! Once the appliance has been installed, the power supply cable and the electrical socket must be easily accessible.

! The cable must not be bent or compressed.

! The cable must be checked regularly and replaced by authorised technicians only (*see Assistance*).

! The manufacturer declines any liability should these safety measures not be observed.

Your appliance is supplied with a 13amp fused plug that can be plugged into a 13amp socket for immediate use. Before using the appliance please read the instructions below.

WARNING:

THIS APPLIANCE MUST BE EARTHED.

Replacing fuse covers:

When replacing a faulty fuse, a 13amp ASTA approved fuse to BS 1362 should always be used and the fuse cover re-fitted.

If the fuse cover is lost, the plug must not be used until a replacement is obtained.

Replacement fuse covers:

If a replacement fuse cover is fitted, it must be of the correct colour as indicated by the coloured marking or the colour that is embossed in words on the base of the plug.

Changing the plug:

Removing the plug

If your appliance has a non-rewireable moulded plug and you should wish to remove it to add a longer cable or to re-route the mains cable through partitions, units etc. please ensure that either:

- The plug is replaced by a fused 13amp re-wireable plug bearing the BSI mark of approval.

or

- The mains cable is wired directly into a 13amp cable outlet, controlled by a switch (in compliance with BS 5733) which is accessible without moving the appliance.

Disposing of the plug

Cut off and dispose of the supplied plug if it does not fit your socket. The cable should be cut as close as possible to the moulded plug.

Remove the fuse.

WARNING:

To avoid a shock hazard do not insert the discarded plug into a socket anywhere else.

Fitting a new plug

IMPORTANT:

WIRES IN THE MAINS LEAD ARE COLOURED IN ACCORDANCE WITH THE FOLLOWING CODE...

Green and Yellow - Earth
Blue - Neutral
Brown - Live

As the colours of the wires in the mains lead may not correspond with the coloured markings identifying the terminals in your plug, proceed as follows:

- Connect Green and Yellow wire to terminal marked 'E' or  or coloured Green and Yellow.
- Connect Brown wire to terminal marked 'L' or coloured red or brown.
- Connect Blue wire to terminal marked 'N' or coloured Black or Blue.

If a 13amp plug (BS 1363) is used it must be fitted with a 13amp fuse. A 15amp plug must be protected by a 15amp fuse, either in the plug or adaptor or at the distribution board.

If you are in any doubt about the electrical supply to your machine, consult a qualified electrician before use.

CE Marking certifies that this appliance conforms to the following EEC directives :

**Low Voltage Equipment - 73/23/EEC & 93/68 EEC
Electromagnetic Compatibility 89/336/EEC, 92/31/EEC
& 93/68/EEC**

Description of the appliance

GB

Control panel

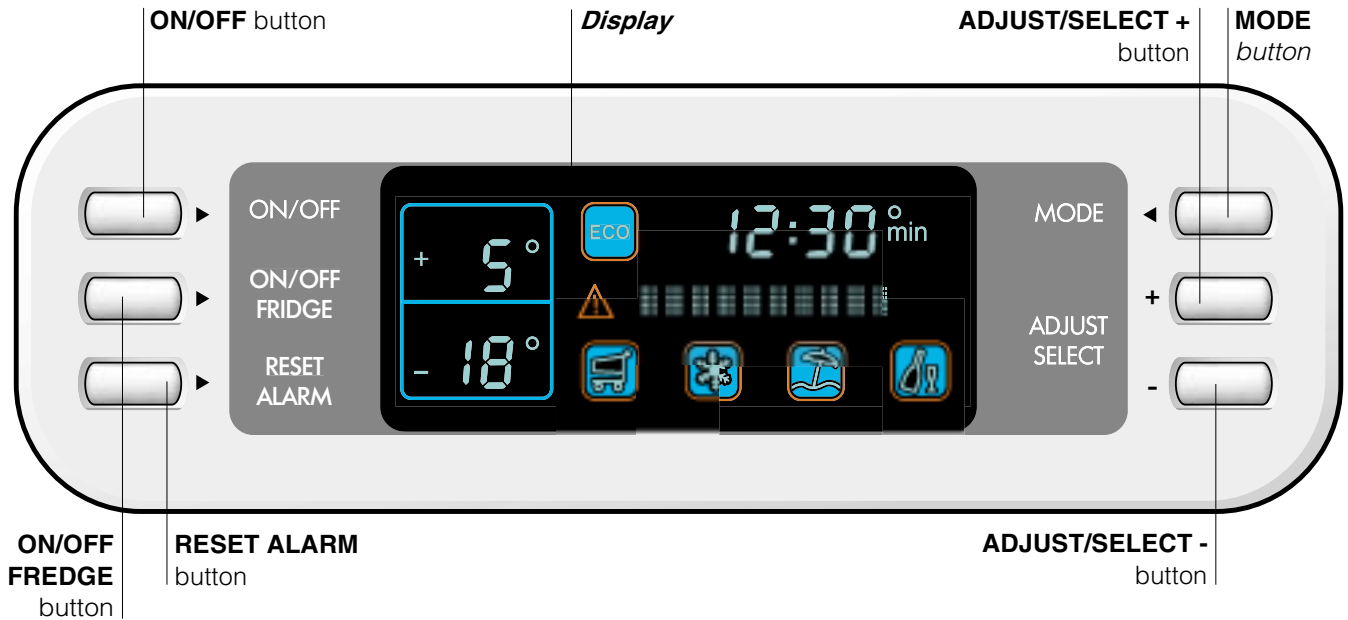

- **ON/OFF** button switches the whole appliance on and off (refrigerator compartment and freezer compartment). It must be held down for at least 2 seconds. *See Start-up and use and Maintenance and care.*
- **ON/OFF FRIDGE** button switches the refrigerator compartment on and off. It must be held down for at least 2 seconds.
- **RESET ALARM** button switches off the sound alarm (press once) and deletes the alarm messages from the scrolling text on the display (press a second time). *See Troubleshooting.*
- **MODE** selects the various display settings and functions. *See Display and Start-up and use.*
- **ADJUST/SELECT +** button activates the functions and modifies the temperature, time, date and language settings. *See Display and Start-up and use.*
- **ADJUST/SELECT -** button deactivates the functions and modifies the temperature, time, date and language settings. *See Display and Start-up and use.*
- **Display** programmes the appliance and controls its operation. *See Display*

Description of the appliance

Overall view

GB

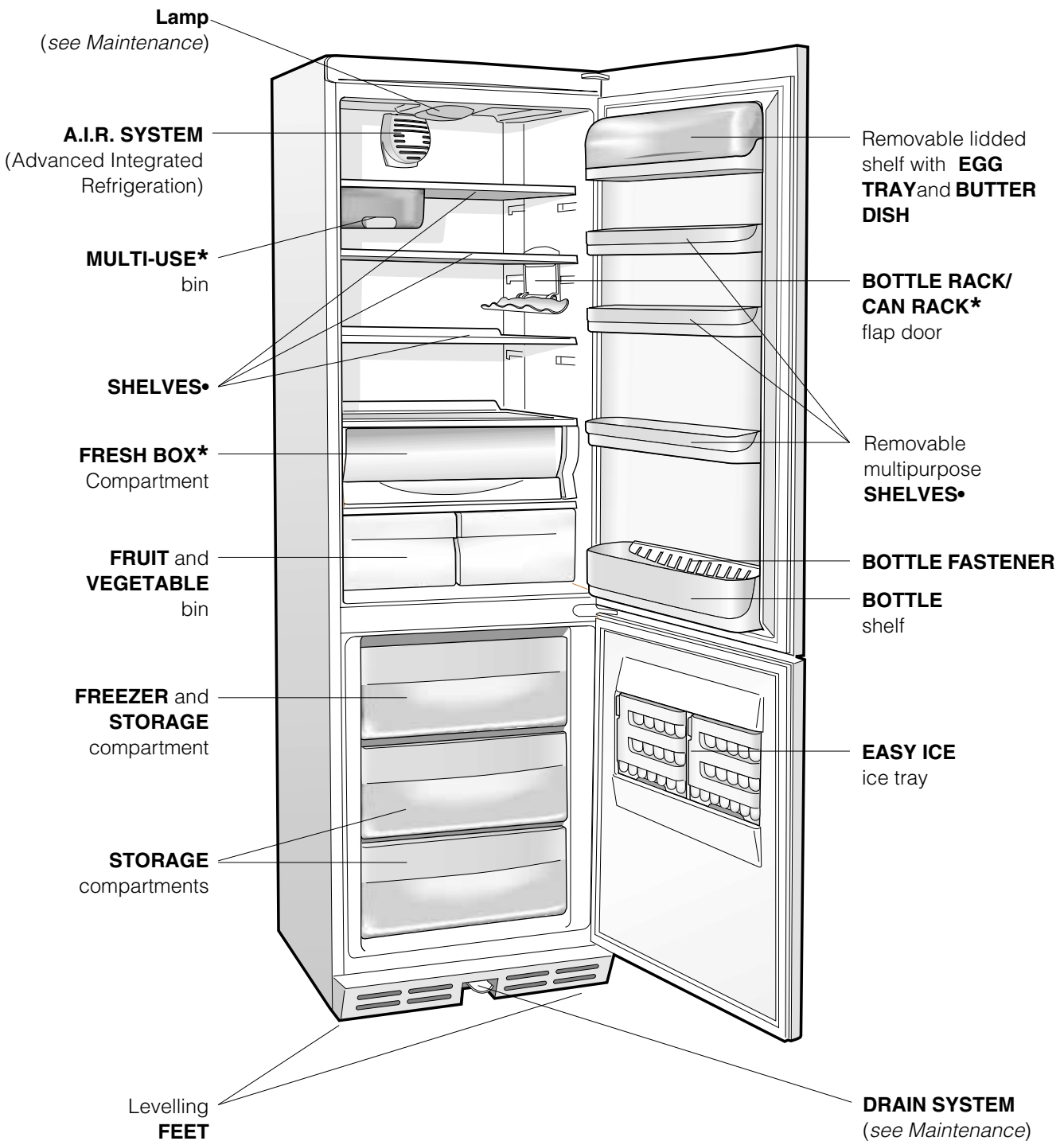

• Varies by number and/or position.

* Available only on certain models.

Accessories

GB

Refrigerator compartment

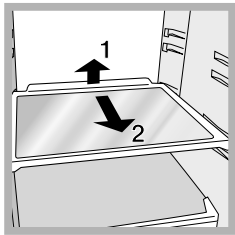

SHELVES*: thanks to the special rails the shelves are removable and the height is adjustable (see *diagram*), allowing easy storage of large containers and food. Height can be adjusted without complete removal of the shelf.

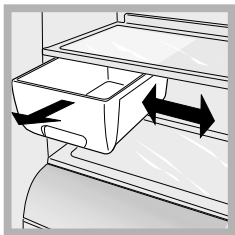

MULTI-USE bin*: to store food (such as cold meats) for a long time and also prevent odours from lingering in the refrigerator. It can be removed for use and it may be shifted sideways to optimise space (see *diagram*).

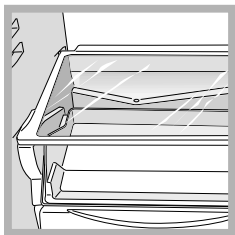

FRESH BOX*: for fresh meat and fish. Due to the compartment's low temperature (the coldest in the refrigerator), food can be stored for up to one week. It can also be used for "cold meals."

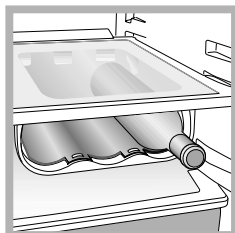

WINE AREA*: to store up to three bottles of wine (see *diagram*). The air circulates freely between the bottles guaranteeing rapid cooling. When not in use, close it to increase the space on the shelf.

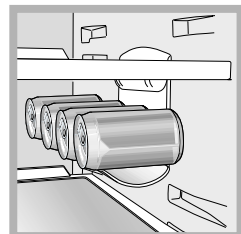
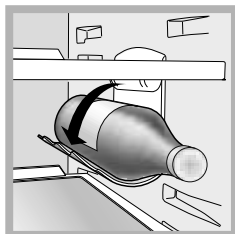

BOTTLE RACK/ CAN RACK* flap door: to store a bottle or several cans horizontally (see *diagram*). When not in use, close the flap door to increase the space in the refrigerator compartment.

- Varies by number and/or position.
- * Available only on certain models.

Freezer compartment

ICE TRAYS: to make ice.

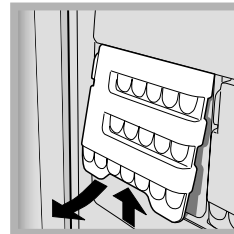

1. Pull out the tray by pushing it up and then outwards (see *diagram*). Check that the tray is completely empty and fill it with water through the opening provided.

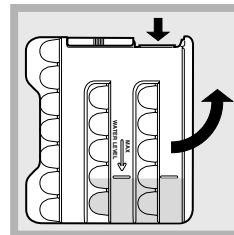

2. Take care not to exceed the level indicated (MAX WATER LEVEL). Excess water prevents the ice cubes from dispensing (if this happens, wait for the ice to melt and empty the tray).

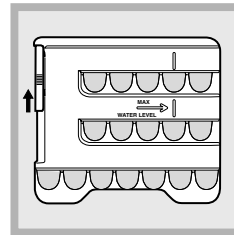

3. Turn the tray 90°: the water fills up the moulds (see *diagram*). Close the opening with the lid and replace. When the ice has formed (minimum time approximately 8 hours), knock the tray against a hard surface.



ICE PARTY: to bring a bottle of sparkling wine or champagne to the right temperature. Place it in the bucket provided inside the FREEZER and STORAGE compartment. The bucket may be used to serve the bottle, keeping it cool. See *Display*.

Display description

GB

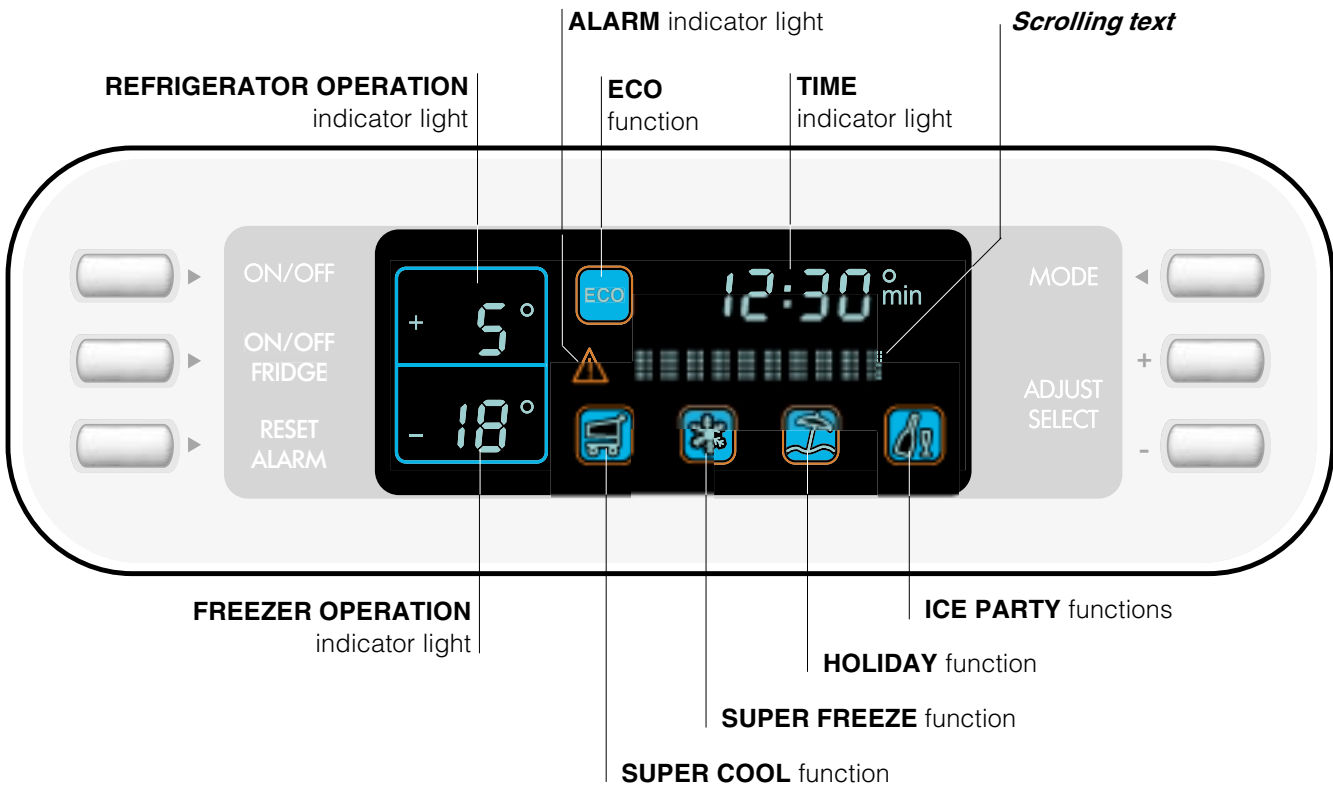

- **REFRIGERATOR OPERATION indicator light:** displays the set temperature (static digit) or the temperature that is being set (flashing digit) for the refrigerator compartment. OFF indicates that the compartment is off.
 - **ALARM indicator light:** when this goes on it indicates a critical situation (door open, high temperature) See *Troubleshooting*.
 - **ECO function:** displays function status Automatically sets the optimal temperature to store food while minimizing energy consumption.
 - **TIME indicator light:** displays the time. This is also used to set the date and time.
 - **Scrolling text:** displays information on the status of the appliance and on how to use the display. It is also used to set the language.
 - **FREEZER OPERATION indicator light:** displays the set temperature (static digit) or the temperature that is being set (flashing digit) for the freezer compartment. OFF indicates that the compartment is off.
 - **SUPER COOL function:** displays function status. This is the rapid cooling function of the refrigerator compartment. It deactivates automatically. See *Start-up and use*.
 - **SUPER FREEZE function:** displays function status. This is the rapid cooling function of the freezer compartment. It deactivates automatically. See *Start-up and use*.
 - **HOLIDAY function:** displays the condition (disabled, selected or enabled) of the HOLIDAY function (optimal temperatures in the event of long-term absences without having to turn the appliance off).
 - **ICE PARTY function:** displays function status. It reduces the temperature of the freezer for the period of time required to cool a bottle. A buzzer sounds when the correct temperature has been reached. See *Accessories*.
- ! The function symbols light up in various ways to indicate their status (deactivated, selected or activated).

Using the display

setting the temperature

When the appliance is switched on, the standard storage temperatures are automatically set:

- +5°C for the refrigerator compartment
- -18°C for the freezer compartment.

The temperatures that may be set are the following:

- between +2°C and +8°C for the refrigerator compartment
- between -18°C and -26°C for the freezer compartment

To set the temperature:

1. Press the MODE button until the value flashes on the refrigerator compartment or freezer compartment display.
2. To increase the temperature, press the ADJUST/SELECT+ button.

To decrease the temperature, press the ADJUST/SELECT- button.

Each time the button is pressed, the value increases by 1°C.

3. Confirm the choice by pressing the MODE button within ten seconds: the value will stop flashing; If the choice is not confirmed, the temperature that had been set before the operation will appear on the display.

! The ECO function reduces the possible adjustments: from +4°C to +6°C for the refrigerator and from -18°C to -20°C for the freezer.

! When the HOLIDAY function is enabled, temperature regulations cannot be made, but the appliance automatically sets itself to the best setting for the situation: +12°C for the refrigerator compartment (if enabled) and -18°C for the freezer compartment.

Function status



function activated (green symbol with blue inside on)



function selected (green symbol with red border on)



function deactivated (green symbol only on)

Activating and deactivating the SUPER COOL, ECO, SUPER FREEZE, HOLIDAY, ICE PARTY functions.

1. Press the MODE button until the desired function is selected.
2. To activate, press the ADJUST/SELECT + button. To deactivate, press the ADJUST/SELECT - button.
3. Confirm the choice by pressing the MODE button within ten seconds. If the choice is not confirmed, the function that had been set before the operation will appear on the display.

Once the operation is over, the red border goes off.

If the function was activated: green symbol with blue inside on. If the function was deactivated: green symbol only on.

Setting the date and time

The settings are in series and it is not possible to adjust the date if the time has not been set before:

1. Press the MODE button repeatedly until the SET TIME [+/-] appears on the scrolling text display.
2. To scroll forward one hour press the ADJUST/SELECT+ button. To scroll back one hour press the ADJUST/SELECT- button.
3. Confirm the choice by pressing the MODE button within ten seconds. If the choice is not confirmed, the time that had been set before the operation will appear on the display.

Once the hours have been set, the minutes, days, months and years can be set by following steps 1-3.

Setting the language

1. Press the MODE button repeatedly until the language setting screen appears on the scrolling text display.
2. To scroll forward, press the ADJUST/SELECT + button. To scroll back, press the ADJUST/SELECT - button.
3. Confirm the choice by pressing the MODE button within ten seconds. If the choice is not confirmed, the language that had been set before the operation will appear on the display.

! The first time that the appliance is switched on, the language setting request screen appears automatically on the display: follow the described procedure.

Switch off the sound and visual alarms

Press the RESET ALARM button: by pressing it once, the sound alarms are switched off; by pressing it a second time, the alarm messages are deleted from the scrolling text on the display.

! The open door alarm is stopped by closing it (see *Troubleshooting*).

! If DEMO MODE appears on the display, the appliance is in exhibition mode, that is, it does not cool despite the fact that the display and the internal lamp are on. To exit this mode, press the MODE, ADJUST/SELECT+ and ADJUST/SELECT- buttons simultaneously for at least three seconds.

Starting the appliance

! **Before starting the appliance, follow the installation instructions** (see *Installation*).

! Before connecting the appliance, clean the compartments and accessories well with lukewarm water and bicarbonate of soda.

! The appliance comes with a motor protection control system which makes the compressor start approximately 8 minutes after being switched on. The compressor also starts each time the power supply is cut off whether voluntarily or involuntarily (blackout).

Insert the plug into the electrical socket and, if OFF appears on both indicator displays (refrigerator and freezer), switch on the appliance by holding down the ON/OFF button for at least two seconds:

- the refrigerator is set at a temperature of +5°C.
- the freezer is set at a temperature of -18°C.

To cool the two compartments more rapidly, activate the SUPER COOL and SUPER FREEZE functions (see *Display*).

A.I.R. SYSTEM (Advanteg Integrated Refrigeration)

It is recognizable due to the presence of the mechanism on the top part of the refrigerator compartment (see *diagram*). The A.I.R. System maintains a constant fridge temperature to keep food fresher for longer and will quickly restore the temperature to the correct level, even if the door is opened frequently: the blown air (A) is cooled when it comes into contact with the cold wall, whereas the hotter air (B) is sucked up (see *diagram*).

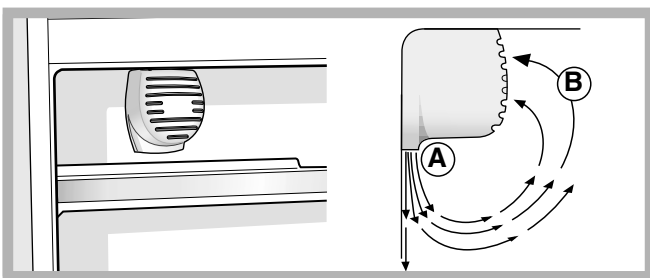

Using the refrigerator to its full potential

- Adjust the temperature using the display.
- Activate the SUPER COOL function to lower the temperature quickly. For example, when you place a large number of new food items inside a fridge, the internal temperature will rise slightly. The function quickly cools the groceries by temporarily reducing the temperature until it reaches the ideal level.
- Place only cold or lukewarm foods in the compartment, not hot foods (see *Precautions and tips*).
- Remember that cooked foods do not last longer than raw foods.
- Do not store liquids in open containers. They will increase humidity in the refrigerator and cause condensation to form.

Using the freezer to its full potential

- Adjust the temperature using the display.
- To freeze a lot of food, activate the SUPER FREEZE function. The function is automatically disabled after 24 hours or once the optimal temperature has been reached.
- Do not refreeze food that has been defrosted or that is defrosting; this food must be eaten within 24 hours or may be frozen again after it has been cooked.
- Fresh food that needs to be frozen must not come into contact with food that has already been defrosted. Fresh food must be packed in the top FREEZER compartment where the temperature drops below -18°C and guarantees rapid freezing.
- Do not place glass bottles which contain liquids, and which are corked or hermetically sealed in the freezer because they could break.
- The maximum quantity of food that may be frozen daily is indicated on the plate containing the technical properties located on the bottom left side of the refrigerator compartment (for example: Kg/24h 4).

! Do not open the door during freezing.

! If there is a power cut or malfunction, do not open the freezer door. This will help maintain the temperature inside the freezer, ensuring that foods are conserved for at least 9 -14 hours.

Maintenance and care

GB

Switching the appliance off

During cleaning and maintenance it is necessary to disconnect the appliance from the electricity supply:

1. hold the ON/OFF button down for more than two seconds until OFF appears on both indicator displays (refrigerator and freezer).
2. pull the plug out of the socket

! If this procedure is not followed, the alarm may sound. This alarm does not indicate a malfunction. To restore normal operation, it is sufficient to hold the ON/OFF button down for more than two seconds. To disconnect the appliance, follow points 1 and 2.

Cleaning the appliance

- The external and internal parts, as well as the rubber seals may be cleaned using a sponge that has been soaked in lukewarm water and bicarbonate of soda or neutral soap. Do not use solvents, abrasive products, bleach or ammonia.
- The removable accessories may be soaked in warm water and soap or dishwashing liquid. Rinse and dry them carefully.
- The back of the appliance may collect dust which can be removed by delicately using the hose of a vacuum cleaner set on medium power. The appliance must be switched off and the plug must be pulled out before cleaning the appliance.

Avoiding mould and unpleasant odours

- The appliance is manufactured with hygienic materials which are odour free. In order to maintain an odour free refrigerator and to prevent the formation of stains, food must always be covered or sealed properly.
- If you want to switch the appliance off for an extended period of time, clean the inside and leave the doors open.

Defrosting

WARNING: do not damage the refrigeration circuit. Do not use mechanical devices or other tools to speed up the defrosting process, unless they have been recommended by the manufacturer.

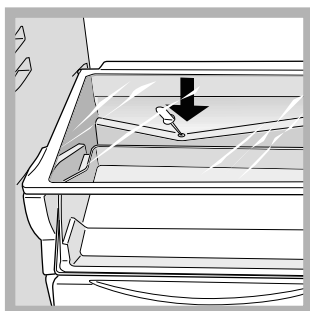

How to Defrost the Refrigerator

This appliance defrosts automatically and the water is channeled to the back toward the drain installed for this purpose (see diagram). Here, the heat produced by the compressor will make it

evaporate. The only thing you must do is to periodically check and clean the hole of the drain, which is located behind the vegetable crispers, so that the water drains properly.

How to defrost the freezer compartment

- Remove the frost from time to time with the aid of the special scraper provided (do not use knives or metal objects).
- If the frost is more than 5 mm thick, then you must defrost the freezer completely. Proceed as follows: one day before enabling the SUPER FREEZE 24-hour; it helps give the food a healthy extra "cold shock". After 24 hours, the freezing function is automatically disabled but you can disable it yourself from the display. Turn the appliance off by pressing the ON/OFF button for more than two seconds. WARNING: this operation switches off the whole appliance (including the fridge compartment). Wrap all frozen foods in newspaper and place them either in another refrigerator or in a cool place. Leave the door open, so as to allow all the frost to melt completely, helping it along with containers filled with lukewarm water.

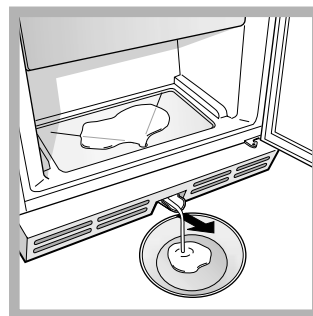

The unit is provided with a system which allows the defrost water to be collected in a container to be placed beneath the unit (see diagram).

Clean and dry thoroughly before restarting the appliance. Remember that the motor will not start immediately, but rather after approximately 8 minutes.

Replacing the light bulb

To replace the light bulb in the refrigerator compartment, pull out the plug from the electrical socket. Follow the instructions below.

Access the light bulb (A) by unscrewing the fixing screw (B) which is located at the back of the lampcover, as shown (see diagram). Replace it with a similar light bulb, the power of which should not exceed 15W.

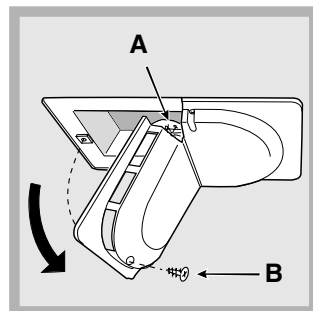

! The appliance was designed and manufactured in compliance with international safety standards. The following warnings are provided for safety reasons and must be read carefully.

 This appliance complies with the following Community Directives:

- 73/23/EEC of 19/02/73 (Low Voltage) and subsequent amendments;
- 89/336/EEC of 03.05.89 (Electromagnetic Compatibility) and subsequent amendments;
- 2002/96/CE..



General safety

- The appliance was designed for domestic use inside the home and is not intended for commercial or industrial use.
- The appliance must be used to store and freeze food products by adults only and according to the instructions in this manual.
- The appliance must not be installed outdoors, even in covered areas. It is extremely dangerous to leave the appliance exposed to rain and storms.
- Do not touch the appliance with bare feet or with wet or moist hands and feet.
- Do not touch the internal cooling elements: this could cause skin abrasions or frost/freezer burns.
- When unplugging the appliance always pull the plug from the mains socket, do not pull on the cable.
- Before cleaning and maintenance, always switch off the appliance and disconnect it from the electrical supply. It is not sufficient to press the ON/OFF button on OFF (appliance off) to eliminate all electrical contact.
- In the case of a malfunction, under no circumstances should you attempt to repair the appliance yourself. Repairs carried out by inexperienced persons may cause injury or further malfunctioning of the appliance.
- Do not use devices or tools other than the special scraper provided inside the compartments.
- Do not put ice cubes taken directly from the freezer into your mouth.
- Do not allow children to tamper with the controls or play with the appliance. Under no circumstance should they be allowed to sit on the bins or to hang from the door.
- Keep packaging material out of the reach of children! It can become a choking or suffocation hazard.

Disposal

- Observe local environmental standards when disposing packaging material for recycling purposes.
- The European Directive 2002/96/EC on Waste Electrical and Electronic Equipment (WEEE), requires that old household electrical appliances must not be disposed of in the normal unsorted municipal waste stream. Old appliances must be collected separately in order to optimise the recovery and recycling of the materials they contain and reduce the impact on human health and the environment. The crossed out “wheeled bin” symbol on the product reminds you of your obligation, that when you dispose of the appliance it must be separately collected. Consumers should contact their local authority or retailer for information concerning the correct disposal of their old appliance.

Respecting and conserving the environment

- Install the appliance in a fresh and well-ventilated room. Ensure that it is protected from direct sunlight and do not place it near heat sources.
- Try to avoid keeping the door open for long periods or opening the door too frequently in order to conserve energy.
- Do not fill the appliance with too much food: cold air must circulate freely for food to be preserved properly. If circulation is impeded, the compressor will work continuously.
- Do not place hot food directly into the refrigerator. The internal temperature will increase and force the compressor to work harder and will consume more energy.
- Defrost the appliance if ice forms (*see Maintenance*). A thick layer of ice makes cold transference to food products more difficult and results in increased energy consumption.
- Regularly check the door seals and wipe clean to ensure they are free of debris and to prevent cold air from escaping (*see Maintenance*).

Troubleshooting

GB

If the appliance does not work, before calling for Assistance (see *Assistance*), check for a solution from the following list.

Malfunctions:

The display is completely switched off.

The motor does not start.

The display is on but it is dim.

a) The alarms goes off and the lamp in the refrigerator compartment flashes.

b) The alarm goes off and a message appears on the scrolling text of the display.

c) The alarm goes off and a message appears on the scrolling text of the display.

The refrigerator and the freezer do not cool well.

The food inside the refrigerator is beginning to freeze.

The motor runs continuously.

The appliance makes a lot of noise.

Early ending of functions

Possible causes / Solutions:

- The plug has not been inserted into the electrical socket, or not far enough to make contact, or there is no power in the house.
- The appliance comes with a motor protection control (see *Start-up and use*).
- Pull out and reverse the plug before putting it back in the socket.
- a) The refrigerator door has remained open for more than two minutes. The buzzer stops when the door is closed or by pressing the RESET ALARM button. or the correct switching-off procedure was not followed (see *Maintenance*).
- b) The temperature of the freezer is too high. The freezer will maintain a temperature of around 0°C so that the food will not refreeze, allowing you to eat it within 24 hours or to freeze it again after cooking them.
- c) The temperature of the freezer has reached a dangerous level. the food must not be eaten. The freezer will reach a temperature of -18°C. To switch off the buzzer, press the RESET ALARM button. Press again to delete the message on the display and to restore normal operation.
- The doors do not close properly or the seals are damaged.
- The doors are opened too frequently.
- The temperature that has been set is too high (see *Start-up and use*).
- The refrigerator or the freezer have been over-filled.
- The temperature that has been set is too low (see *Start-up and use*).
- The SUPER COOL and/or SUPER FREEZE and/or ICE PARTY functions are active.
- The door is not closed properly or is continuously opened.
- The outside ambient temperature is very high.
- The appliance has not been installed on a level surface (see *Installation*).
- The appliance has been installed between cabinets that vibrate and make noise.
- The internal refrigerant makes a slight noise even when the compressor is off. This is not a defect, it is normal.
- Electrical disturbance on the network or brief interruptions of the power supply

Before calling for Assistance:

- Check if the malfunction can be solved on your own (see *Troubleshooting*).
- If the appliance is still not working and the problem persists despite having carried out all the checks, call your nearest Service Centre.

Communicating:

- type of malfunction
- appliance model (Mod.)
- serial number (S/N)

This information can be found on the data plate located on the bottom left side of the refrigerator compartment.

model				serial number			
Mod. RG 2330				TI	Cod. 93139180000		S/N 704211801
240 V-	Hz	150 W	W Fuse	A	mm	Max 15	
Total	340	75			Freez. Capac	Class	
Gross Bruto Brut		Gross Bruto Brut	Net Util Utile	Gross Bruto Brut	Poder de Cong kg/24 h	4,0	Classe N
Compr. Syst.	R 134 a	Test	Pressure HIGH-235				
Kompr.	kg 0,090	P.S-I.	LOW 140				
Made in Italy	13918						

Never use unauthorized technicians and never accept replacement parts that are not original

Notes

GB

After Sales Service

"No company is better positioned to offer an after sales service on a Hotpoint appliance than us - the manufacturer"

As part of our commitment to you, all Hotpoint appliances have the added benefit of a fully inclusive parts and labour guarantee for the first 12 months. In addition to this you also have the advantage of **free replacement parts for the first 5 years** when fitted by a Hotpoint engineer. When the 12 months parts and labour guarantee expires we offer the following after sales service options:

Repair Service and Information Help Desk

UK: 08709 066066

www.theservicecentre.co.uk

Republic of Ireland: 1850 302 200

Note: Our operators will require the Model number and the Serial number of your appliance

Available 364 days a year with a fast, effective and value for money service. We have the largest white goods repair service in the UK with over 1200 of our own fully trained engineers. All repairs include a parts and labour guarantee for 12 months from the date of the repair.

If you require any information or have any questions about your appliance, our operators are on hand with help and advice.

All this ensures that you will receive the best available after sales service possible.

Extended Warranties

UK: 08709 088 088

www.theservicecentre.co.uk

Republic of Ireland: 1850 502 200

Whether you have just one or a number of Hotpoint appliances in your kitchen, we offer two service cover plans to give you total peace of mind.

- Repair Protection Plan period
- Kitchen Cover
- FREE service repairs for a single Hotpoint appliance during the of cover.
- FREE service repairs for all your Hotpoint appliances less than 8 years old.

Genuine Parts and Accessories UK: 08709 077 077

www.theservicecentre.co.uk

Republic of Ireland: (01) 842 6836

A wide range of genuine parts and accessories are available from our hotline or through our web site.

Genuine parts and accessories, extended warranties and service repairs are all available on our web-site at:



www.theservicecentre.co.uk

Guarantee

"Satisfaction guaranteed or your money back"

We give you a unique 'satisfaction guaranteed' promise - **valid for 90 days** - after you have purchased your Hotpoint appliance. If there is a technical problem simply call Hotpoint Repair service or visit our web-site at www.theservicecentre.co.uk and where necessary, we will arrange for an engineer to call. If the technical problem is not resolved under this guarantee, **we will replace your machine or, if you prefer, give you your money back.**

All Hotpoint appliances carry a fully inclusive 12 month parts and labour guarantee as well as free replacement parts for the first 5 years (except microwaves, selected integrated appliances and cooker hoods, which have a one year guarantee) provided that they are fitted by a Hotpoint engineer.

Guarantee terms and conditions

Your guarantee is only applicable in the United Kingdom or Republic of Ireland and is subject to the following provisions that your appliance:

- Has been installed and used correctly in accordance with this instruction booklet.
- Has been used solely for domestic purposes and is located on domestic premises (ie. not for commercial or trade use).
- Has been properly connected to a suitable electrical supply voltage as stated on the appliance rating plate.
- Has not been subject to misuse, accident, modified or repaired by anyone other than one of our own service engineers.



For pre purchase information on any other Hotpoint product call: 08701 50 60 70
or visit: www.hotpoint.co.uk



Recycling & Disposal Information

As part of Hotpoint's continued commitment to helping the environment, Hotpoint reserves the right to use quality recycled components to keep down customer costs and minimise material wastage.

Please dispose of packaging and old appliances carefully.

To minimise risk of injury to children, remove the door, plug and cut mains cable off flush with the appliance. Dispose of these parts separately to ensure that the appliance can no longer be plugged into a mains socket, and the door cannot be locked shut.



Key Contacts

After Sales Service

Over 1200 trained specialists, directly employed by us, ensure that you can have complete confidence in both the appliances and services we offer.



Repair Service and Information Desk

UK: 08709 066 066

(Open 8 to 8 Mon - Fri, 8 to 6 Sat, 10 to 4 Sun & Bank Holidays)

www.theservicecentre.co.uk

Republic of Ireland: 1850 302 200

Note: Our operators will require the following information:

Model number:

Serial number:

Extended Warranties

UK: 08709 088 088

(Open 8 to 8 Mon - Sun)

www.theservicecentre.co.uk

Republic of Ireland: 1850 502 200

Genuine Parts and Accessories

UK: 08709 077 077

(Open 8-30 to 5-30 Mon - Fri & 9 to 12 Sat)

www.theservicecentre.co.uk

Republic of Ireland: (01) 842 6836