

FARBERWARE® MILLENNIUM®



USE & CARE INSTRUCTIONS ESPRESSO MAKER FES4B

IMPORTANT SAFEGUARDS

When using electrical appliances, basic safety precautions should always be followed, including the following:

1. Read all instructions.
2. Do not touch hot surfaces. Use handles or knobs.
3. To protect against electric shock, do not place cord, plugs, or appliance in water or other liquid.
4. Close supervision is necessary when any appliance is used by or near children.
5. Unplug from outlet when not in use and before cleaning. Allow to cool before putting on or taking off parts, and before cleaning the appliance.
6. Do not operate any appliance with a damaged cord or plug or after the appliance malfunctions, or has been damaged in any manner. Contact Consumer Service for examination, repair or adjustment.
7. The use of an accessory not evaluated for use with this appliance may cause injuries.
8. Do not use outdoors.
9. Do not let cord hang over edge of table or counter, or touch hot surfaces.
10. Do not place on or near a hot gas or electric burner, or in a heated oven.
11. To disconnect, turn the Function Control Knob to the OFF position, then remove plug from wall outlet.
12. Do not use appliance for other than intended use.
13. Be certain Lids are securely in place before operating appliance.
14. Scalding may occur if the Lids are removed during the brewing cycle.
15. The Carafe is designed for use with this appliance. It must never be used on a range top.
16. Do not set a hot Carafe on a wet or cold surface.
17. Do not use a cracked Carafe or a Carafe having a loose or weakened handle.
18. Do not clean Carafe with cleansers, steel wool pads, or other abrasive material.

SAVE THESE INSTRUCTIONS
THIS PRODUCT IS FOR HOUSEHOLD USE ONLY

ADDITIONAL IMPORTANT SAFEGUARDS

WARNING: This appliance generates heat and escaping steam during use. Proper precautions must be taken to prevent the risk of burns, fires, or other injury to persons or damage to property.

1. All users of this appliance must read and understand these Use & Care Instructions before operating or cleaning this appliance.
2. The cord to this appliance should be plugged into a 120V AC electrical outlet only.
3. Use **water only** in this appliance! Do not put any other liquids or food products in this appliance. Do not mix or add anything to the water placed in this appliance, except as instructed in the USER MAINTENANCE INSTRUCTIONS to clean the appliance.
4. **DO NOT** attempt to move an appliance containing hot liquids. Allow appliance to cool completely before moving.
5. Keep appliance at least 4 inches away from walls or other objects during operation. Do not place any objects on top of appliance while it is operating. Place the appliance on a surface that is resistant to heat.
6. If this appliance begins to malfunction during use, turn the Function Control Knob to the OFF position, then immediately unplug the cord. Do not use or attempt to repair the malfunctioning appliance.
7. If this appliance falls or accidentally becomes immersed in water or any other liquid, unplug it immediately. **Do not reach into the water! Do not use this appliance after it has fallen into or has become immersed in water.** Contact Consumer Service for examination and repair.
8. Do not leave this appliance unattended during use.
9. The appliance must be left to cool down sufficiently before adding more water to avoid splattering.
10. Always use fresh, cool water in your appliance. Warm water or other liquids, except as listed in the DESCALING section, may cause damage to the appliance.
11. **DO NOT** put Carafe into a microwave.
12. Keep Function Control Knob in OFF position when not being used.
13. Do not unscrew or remove Pressure Cap while the appliance is in operation as scalding may occur. Wait until brewing cycle is completed and all water and steam has been used up.

CAUTION: Relieve pressure through Steam Tube before removing Pressure Cap or Filter Holder.

POLARIZED PLUG

This appliance has a polarized plug (one blade is wider than the other). To reduce the risk of electric shock, this plug is intended to fit into a polarized outlet only one way. If the plug does not fit fully in the outlet, reverse the plug. If it still does not fit, contact a qualified electrician. Do not attempt to modify the plug in any way.

SHORT CORD INSTRUCTIONS

A short power-supply cord is provided to reduce the risk resulting from becoming entangled in or tripping over a longer cord.

Do not use an extension cord with this product.

PLASTICIZER WARNING

CAUTION: To prevent Plasticizers from migrating from the finish of the counter top or table top or other furniture, place **NON-PLASTIC** coasters or place mats between the appliance and the finish of the counter top or table top.

Failure to do so may cause the finish to darken. Permanent blemishes may occur or stains can appear.

ELECTRIC POWER

If the electrical circuit is overloaded with other appliances, your appliance may not operate properly. It should be operated on a separate electrical circuit from other appliances.

WARNING

TO REDUCE THE RISK OF FIRE OR ELECTRIC SHOCK, DO NOT REMOVE THE BOTTOM COVER. NO USER-SERVICEABLE PARTS INSIDE. REPAIR SHOULD BE DONE BY AUTHORIZED SERVICE PERSONNEL ONLY.

GETTING TO KNOW YOUR FARBERWARE® ESPRESSO MAKER

PRODUCT MAY VARY SLIGHTLY FROM ILLUSTRATIONS

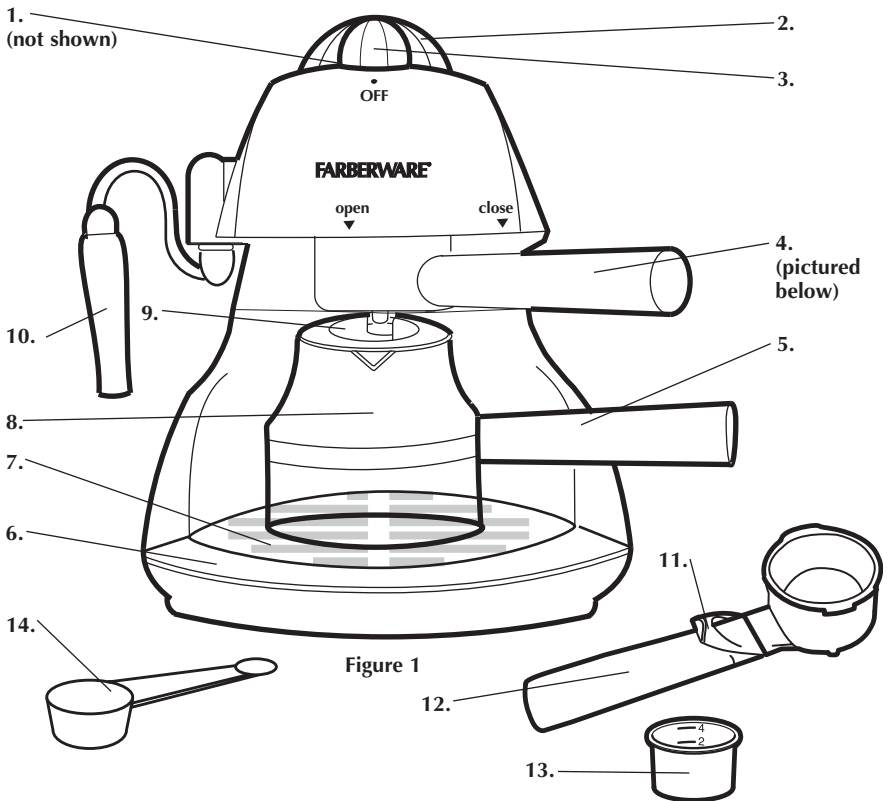

Figure 1

- | | |
|------------------------------------|---------------------------------------|
| 1. Power ON Light | 8. Glass Carafe (P/N 31394) |
| 2. Pressure Cap (P/N 31390) | 9. Carafe Lid (P/N 31395) |
| 3. Function Control Knob | 10. Steam Tube with Cover (P/N 31396) |
| 4. Filter Holder (P/N 31391) | 11. Filter Handle Clip |
| 5. Carafe Handle | 12. Filter Holder Handle |
| 6. Removable Drip Tray (P/N 31392) | 13. Filter Basket (P/N 31397) |
| 7. Drip Plate (P/N 31393) | 14. Measuring Scoop (P/N 31399) |

Before brewing the first time, follow the instructions described in the section: BREWING ESPRESSO, but use water only. Then, repeat the process a second time. Wash all removable parts in warm, soapy water. Rinse, dry and assemble as instructed.

BREWING ESPRESSO

1. Before filling the Water Tank, make sure the Espresso Maker Function Control Knob is turned to the OFF position and the unit is unplugged from the electrical outlet. Unscrew the Pressure Cap on top of the machine by turning it counterclockwise. Lift and turn to remove the Lid.
2. To fill the Water Tank, use the Glass Carafe to measure the volume of fresh cold water required. Do not overfill. The Glass Carafe is marked with water levels for 2 cup (minimum) and 4 cups (maximum). Care should be taken to ensure that the correct amount of water is placed in the Tank, as the Espresso Maker always uses all the water.

3. Close the Pressure Cap tightly by turning it clockwise.

4. Place the Filter Basket into the Filter Holder (see Figure 2). Add the desired quantity of espresso coffee to the Filter Basket using the Measuring Scoop provided (see Figure 3). Spread the espresso coffee evenly in the Filter Basket and lightly press it down. Special marks on the inside of the Filter show the correct espresso coffee levels for 2 and 4 cups. Remove excess espresso coffee from the edge of the Filter.

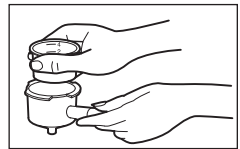

Figure 2

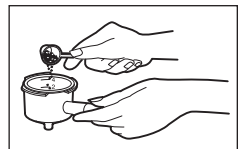

Figure 3

5. Make sure the Filter Handle Clip is unfolded and resting back along the Filter Holder Handle. Position the Filter Holder beneath the water outlet, under the arrow marked “open” and fit it onto the machine. Push it upwards and turn to the right to lock to the “close” position.

NOTE: With one hand on the Pressure Cap, push the Filter Holder firmly to the right to lock in position. The Handle will be locked when it is positioned under the arrow marked “close” (see Figure 4).

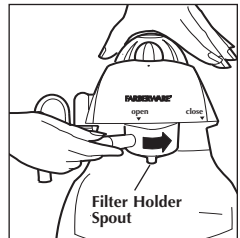

Figure 4

6. Place the Lid on the Carafe with the arrow pointing opposite the Pour Spout.
7. Slide the Glass Carafe with Lid onto the Drip Tray directly under the Spout of the Filter Holder (see Figure 1).
8. Plug the Espresso Maker into a 120V AC electrical outlet.

BREWING ESPRESSO (Continued)

9. Turn the Function Control Knob to ☕ ESPRESSO. The Power ON Light will illuminate (see Figure 5). The espresso will begin to flow from the Filter Holder Spout in 1 to 3 minutes, depending on the amount of water added to the Water Tank. Wait until all the water from the Water Tank has flowed into the Carafe.

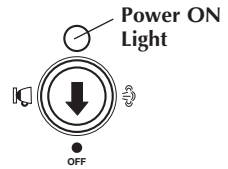

Figure 5

NOTE: The machine can be heard as the pressure builds, water begins to heat and espresso is brewed.

CAUTION: Never operate the Espresso Maker without water in the Water Tank.

10. Turn the Function Control Knob to the OFF position. The Power ON Light will turn off. Remove the Glass Carafe from the Drip Plate and serve.
11. **FOR SAFETY REASONS, BEFORE REMOVING THE PRESSURE CAP OR THE FILTER HOLDER, ALL STEAM WHICH MAY BE PRESENT IN THE WATER TANK MUST BE RELEASED. TO RELEASE STEAM PRESSURE IN THE WATER TANK, TURN THE FUNCTION CONTROL KNOB TO THE ☁️ STEAM POSITION (THE POWER ON LIGHT WILL ILLUMINATE) AND WAIT UNTIL NO FURTHER STEAM EMERGES THROUGH THE STEAM TUBE. THEN TURN THE FUNCTION CONTROL KNOB TO THE OFF POSITION.**

Do not remove the Filter Holder until all steam has been released, and all parts are cool enough to touch.

CAUTION: Avoid contact with any steam.

12. To discard used espresso coffee grounds, allow the Espresso Maker and all parts to cool; remove the Filter Holder by turning the Handle to the left until the Handle is positioned under the arrow marked "open" and separates from the Espresso Maker. Flip the Filter Handle Clip forward so that it holds the Filter Basket in place. Turn the Filter Holder upside-down and tap out the grounds (see Figure 6). Fold the Filter Handle Clip back along the Handle before the next use.



Figure 6

13. To refill the unit for additional servings, remove the Pressure Cap, turn the Function Control Knob to OFF and allow the unit to cool before proceeding with steps 2 through 12 in this Brewing Espresso section of this manual. If the Water Tank is hot, the water may splatter when added.
14. Unplug the Espresso Maker after each use.

PREPARING CAPPUCCINO

In Italy, cappuccino is usually 1 part espresso to 2 parts milk plus froth. Americans love to add cinnamon, sugar, shaved chocolate, nutmeg and/or various liquors to taste.

NOTE: The best frothed milk is obtained when fresh, cold skim milk is used. When frothing milk, the volume of the milk will double.

1. Make sure the Steam Tube Cover is properly attached to the Steam Tube before beginning to froth the milk.
2. Prepare espresso as described in the section: BREWING ESPRESSO. Add extra water to the Water Tank to create steam to froth milk. Use the Glass Carafe to measure the correct volume of water needed. For 2 cups, add water until it reaches the bottom of the handle ring on the Glass Carafe. For 4 cups, add water until it reaches the Pour Spout on the Glass Carafe.
3. Once the brewed espresso reaches the ☁️ STEAM mark on the Carafe, hold a frothing pitcher by the handle and bring up to the Steam Nozzle. Insert the tip of the Nozzle just under the surface of the milk. Turn the Function Control Knob to ☁️ STEAM and begin to froth the milk.

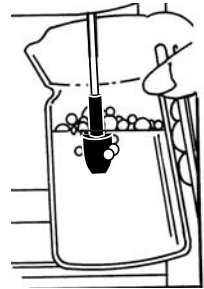

Figure 7

REMINDER: Before frothing, make sure the tip of the Steam Nozzle is just under the surface of the milk. Otherwise, splattering may occur. See Figure 7.

CAUTION: Take extra care as steam is very hot and will also cause the milk to become very hot.

4. When the milk reaches desired froth consistency, turn the Function Control Knob back to ☕ ESPRESSO. Brewing will resume.

NOTE: When preparing cappuccino, use a cappuccino cup with a capacity of at least 5 ounces. Fill each cup half-full with espresso.

5. The froth will not readily pour from the container, since it separates from the heated milk. The top half will be frothed, the bottom half will be milk. Pour in an equal amount of warm milk into each cup of espresso. Spoon the frothed milk onto the top.
6. Clear the Steam Tube of milk BEFORE brewing is finished, as dried milk can be difficult to remove. To do this, put a container in place under the Steam Tube to catch the excess milk and turn the Function Control Knob ☁️ STEAM. Turn the Function Control Knob back to ☕ ESPRESSO to complete brewing. After brewing is completed, turn the Function Control Knob to OFF.

CAUTION: Avoid contact with any steam.

7. **FOR SAFETY REASONS, BEFORE REMOVING THE PRESSURE CAP OR THE FILTER HOLDER, ALL STEAM WHICH MAY BE PRESENT IN THE WATER TANK MUST BE RELEASED. TO RELEASE STEAM PRESSURE IN THE WATER TANK, TURN THE FUNCTION CONTROL KNOB TO THE ☁️ STEAM POSITION (THE POWER ON LIGHT WILL ILLUMINATE) AND WAIT UNTIL**

PREPARING CAPPUCCINO (Continued)

NO FURTHER STEAM EMERGES THROUGH THE STEAM TUBE. THEN TURN THE FUNCTION CONTROL KNOB TO THE OFF POSITION.

Do not remove the Filter Holder until all steam has been released, and all parts are cool enough to touch.

8. After all the steam is safely released and all parts have cooled, remove the Filter Holder by turning the Handle to the left until the Handle is positioned under the arrow marked "open" and separates from the Espresso Maker. Flip the Filter Handle Clip forward so that it holds the Filter Basket in place. Turn the Filter Holder upside-down and tap out the grounds (see Figure 6). Fold the Filter Handle Clip back along the Handle before the next use.
9. Unplug the Espresso Maker after each use.

USER MAINTENANCE INSTRUCTIONS

This appliance requires little maintenance. It contains no user serviceable parts. Do not try to repair it yourself. Any servicing requiring disassembly must be performed by a qualified appliance repair technician.

1. Unplug the Espresso Maker from the electrical outlet and allow to cool completely before cleaning.

CAUTION: The Filter Basket and Filter Holder are hot after brewing. Allow to cool thoroughly before touching.

2. The Filter Holder and Filter Basket should be emptied and rinsed thoroughly with warm water after every use. If necessary, clean the Filter Basket with a kitchen brush. A pin may be used to clear any clogged holes. Dry thoroughly.

CAUTION: The Steam Tube may be hot. Allow to cool completely.

3. The Steam Tube Cover pulls down and off the Steam Tube for easy cleaning. Hand wash the Steam Tube Cover in hot water. From time to time, use a pin to clean the hole in the end of the Steam Tube. Dry the Steam Tube and replace the Steam Tube Cover after cleaning.
4. To remove the Drip Tray, remove the Carafe from the Drip Plate. Remove the Filter Holder from the machine. Remove the Drip Plate and then the Drip Tray. Empty water, rinse, and replace.
5. Wipe the outside of your Espresso Maker with a damp cloth. Never use solvents or any detergents that may scratch or damage the surface of the machine.
6. **NEVER IMMERSE THE APPLIANCE IN WATER OR ANY OTHER LIQUID.**

DESCALING

Your Espresso Maker should be regularly descaled. Distilled white vinegar may be used to descale the appliance. We suggest the following intervals:

- Normal water: every 6 months
 - Hard water: every 3 months
 - Very hard water: every 6 to 8 weeks
1. Remove the Filter Basket from its Holder. Fit the empty Filter Holder into the Espresso Maker as described in the section: BREWING ESPRESSO.
 2. Fill the Glass Carafe with distilled white vinegar and pour into Water Tank.
 3. Place the empty Glass Carafe back onto the Drip Tray.
 4. Turn the Function Control Knob to the  ESPRESSO position; the Power ON Light will illuminate and the vinegar will begin to flow through the machine. When all of the vinegar has flowed into the Carafe, turn the Function Control Knob to the OFF position. The Power ON Light will go off. Empty the Carafe and allow the Espresso Maker to cool. Repeat the process if necessary.
 5. To clean/descale the Steam Tube, place a heat-resistant frothing pitcher under the Steam Nozzle. Carefully open the Function Control Knob toward the end of the cleaning process by turning the knob counterclockwise. Beware of hot escaping steam.
 6. After descaling, flush your machine by operating 2 or 3 times using fresh, cold water and clean all detachable parts. You can help prevent build-up of deposits, especially in hard water areas, by leaving your machine empty between uses.

FARBERWARE®

LIMITED ONE-YEAR WARRANTY

Warranty Coverage: This product is warranted to be free from defects in materials or workmanship for a period of one (1) year from the original purchase date. This product warranty is extended only to the original consumer purchaser of the product and is not transferable. For a period of one (1) year from the date of original purchase of the product, our Repair Center will, at its option, either (1) repair the product or (2) replace the product with a reconditioned comparable model. These remedies are the purchaser's exclusive remedies under this warranty.

Warranty Service: To obtain warranty service, you must call our warranty service number at 1-800-233-9054 for return instructions on how to deliver the product, in either the original packaging or packaging affording an equal degree of protection to the Repair Center specified below. You must enclose a copy of your sales receipt or other proof of purchase to demonstrate eligibility for warranty coverage.

To return the appliance, ship to:

ATTN: Repair Center
708 South Missouri Street
Macon, MO 63552 USA

To contact us, please write to, call, or email:

Consumer Relations Department
PO Box 7366
Columbia MO 65205-7366 USA
1-800-233-9054
E-mail:consumer_relations@toastmaster.com

What Is Not Covered: This warranty does not cover damage resulting from misuse, accident, commercial use, improper service or any other damage caused by anything other than defects in material or workmanship during ordinary consumer use. This warranty is invalid if the serial number has been altered or removed from the product. This warranty is valid only in the United States and Canada.

LIMITATION ON DAMAGES: THERE SHALL BE NO LIABILITY FOR ANY INCIDENTAL OR CONSEQUENTIAL DAMAGES FOR BREACH OF ANY EXPRESS OR IMPLIED WARRANTY OR CONDITION ON THIS PRODUCT.

DURATION OF IMPLIED WARRANTIES: EXCEPT TO THE EXTENT PROHIBITED BY APPLICABLE LAW, ALL IMPLIED WARRANTIES AND CONDITIONS, INCLUDING, WITHOUT LIMITATION, IMPLIED WARRANTIES AND CONDITIONS OF MERCHANTABILITY AND FITNESS FOR A PARTICULAR PURPOSE OR USE ON THIS PRODUCT ARE LIMITED IN DURATION TO THE DURATION OF THIS WARRANTY.

Some jurisdictions do not allow the exclusion or limitation of incidental or consequential damages, or allow limitations on how long an implied warranty lasts, so the above limitations or exclusions may not apply to you. This warranty gives you specific legal rights and you may have other rights under the laws of your jurisdiction.

FARBERWARE® and Millennium® are registered trademarks of Farberware Inc.®
Manufactured and sold pursuant to a license from Farberware Inc.®

For more information on our products, visit our website:
www.maxim-toastmaster.com.

©2006 All rights reserved.
Made in China

P/N 61868
5/06