

Progressive Scan DVD Player DHX-202



WARNING

- TO PREVENT FIRE OR SHOCK HAZARD, DO NOT USE THIS PLUG WITH AN EXTENSION CORD, RECEPTACLE OR OTHER OUTLET UNLESS THE BLADES CAN BE FULLY INSERTED TO RESENT BLADE EXPOSURE.
- TO PREVENT FIRE OR SHOCK HAZARD. DO NOT EXPOSE THIS APPLIANCE TO RAIN OR MOISTURE.
- TO PREVENT ELECTRICAL SHOCK, MATCH WIDE BLADE PLUG TO WIDE SLOT FULLY INSERT.



The lightning flash with arrowhead symbol, within an equilateral triangle, is intended to alert the user to the presence of un-insulated "dangerous voltage" within the product's enclosure that may be of sufficient magnitude to constitute a risk of electric shock to persons.



Warning: To reduce the risk of electric shock, do not remove cover (or back), no user serviceable parts inside. Refer servicing to qualified service personnel.



The exclamation point within an equilateral triangle is intended to alert the user to the presence of important operating and maintenance (servicing) instructions in the literature accompanying the appliance.

IMPORTANT SAFETY INSTRUCTIONS

- 1) Read these instructions.
- 2) Keep these instructions.
- 3) Heed all warnings.
- 4) Follow all instructions.
- 5) Do not use this apparatus near water.
- 6) Clean only with dry cloth.
- 7) Do not block any ventilation openings. Install in accordance with the manufacturer's instructions.
- 8) Do not install near any heat sources such as radiators, heat registers, stoves, or other apparatus (including amplifiers) that produce heat.
- 9) Do not defeat the safety purpose of the polarized or grounding-type plug. A polarized plug has two blades with one wider than the other. A grounding type plug has two blades and a third grounding prong. The wide blade or the third prong are provided for your safety. If the provided plug does not fit into your outlet, consult an electrician for replacement of the obsolete outlet.
- 10) Protect the power cord from being walked on or pinched particularly at plugs, convenience receptacles, and the point where they exit from the apparatus.
- 11) Only use attachments/accessories specified by the manufacturer.
- 12) Use only with the cart, stand, tripod, bracket, or table specified by the manufacturer, or sold with the apparatus. When a cart is used, use caution when moving the cart/apparatus combination to avoid injury from tip-over.



- 13) Unplug this apparatus during lightning storms or when unused for long periods of time.
- 14) Refer all servicing to qualified service personnel. Servicing is required when the apparatus has been damaged in any way, such as power-supply cord or plug is damaged, liquid has been spilled or objects have fallen into the apparatus, the apparatus has been exposed to rain or moisture, does not operate normally, or has been dropped.
- 15) This appliance shall not be exposed to dripping or splashing water and that no object filled with liquids such as vases shall be placed on apparatus.

Important Safeguards and Precautions

Power cord protection

To avoid the unit from malfunctioning, and to protect against electric shock, fire or personal injury, please observe the following:

- Hold the plug firmly when connecting or disconnecting the AC power cord.
- Keep the AC power cord away from any heating appliances.
- Never put any heavy objects on the AC power cord.
- Do not attempt to repair or reconstruct the AC power cord in any way.

Location and handling

- Air vents are provided in the cabinet to prevent the temperature inside the unit from rising to dangerous levels. Do not place this unit in closed spaces, cover it, or otherwise block the vents.
- Do not place this unit in direct sunlight or near heat sources.
- Keep this unit away from strong magnetic objects.
- Do not insert or drop anything into this unit through the air vents as this could cause serious damage, possibly resulting in fire.
- Do not place any object containing water or other liquids on this unit. In the event that liquid should enter the cabinet, unplug this unit immediately and contact the service center immediately.
- Do not remove the cabinet. Touching parts inside the cabinet could result in electric shock or damage the unit.
- Do not use the unit in a car.

Nonuse periods

- When the unit is not being used, make sure to keep the unit turned off.
- When left unused for a long period of time, the unit should be unplugged from the household AC outlet.

Disc tray

- Do not put any foreign objects on or in the disc tray.
- Do not push down on or place your fingers or hand in the disc tray.

Stacking

- Place the unit in a horizontal position and do not place anything heavy on top of it.

Condensation

Moisture may form on the pickup lens in the following conditions:

- Immediately after a heater has been turned on near the unit.
- In a steamy or very humid room.
- When the unit is suddenly moved from a cold environment to a warm one.

If moisture forms inside this unit, it may not operate properly. If this happens, remove power and place the unit at a well ventilated area and let the moisture to evaporate before using the unit again.

Copyright

Audio-visual material may consist of copyrighted works which must not be recorded without the authority of the owner of the copyright. Please refer to relevant laws in your country.

Copy protection

This DVD player supports Macrovision® copy protection. On DVD discs that include a copy protection code, if the contents of the DVD disc are copied using a VCR, the copy protection code prevents the videotape copy from playing normally.

Manufactured under license from Dolby Laboratories. "Dolby" and the double-D symbol are trademarks of Dolby Laboratories.

Recommended measures for optimum picture excellence

This unit is a precision device that is constructed using extremely accurate technology.

Soiling or friction affecting the pickup lens or disc drive can impair the image quality. At the worst, neither video nor audio will be played back. To obtain optimum picture quality, the player should be checked (cleaning and replacement of some parts) every 1,000 hours. Note that this period varies depending on the environment (temperature, humidity, dust, etc..) in which the player is used.

Do not attempt to clean the pickup lens yourself.

CAUTION

"VENTILATION SHOULD NOT BE IMPEDED BY COVERING THE VENTILATION OPENINGS WITH ITEMS SUCH AS NEWSPAPER, TABLECLOTHS, CURTAINS, ETC."

"NO OPEN FLAME SOURCES, SUCH AS LIGHTED CANDLES, SHOULD BE PLACED ON THE APPARATUS."

"DO NOT EXPOSE THE APPARATUS TO MOISTURE, LIQUID, OR SPLASHING OF LIQUIDS. DO NOT PLACE OBJECTS FILLED WITH LIQUIDS, SUCH AS VASES, ON THE APPARATUS."



- This appliance is classified as a CLASS 1 LASER product.
- The CLASS 1 LASER PRODUCT marking is located on the rear panel.
- This product contains a low power laser device. To ensure continued safety, do not remove any cover or attempt to gain access to the inside of the product.

Table of Contents

General Information

Features	5
DVD region code	5
Discs that can be played back.....	5
Glossary of disc terms	5
Conventions about this manual	5
Notes on disc	6
Accessories	6
Installing batteries in the remote control	6

Location of Controls

Front panel	7
Back panel	7
Remote control.....	8

Connections

Connecting your DVD player to your TV	9
---	---

Basic Setup

Setup menu	10
System setup	10-11
Language setup	11-12
Audio setup	12
Video setup	13

Playing Discs

General operation	14
Basic playback	14
Playing MP3/JPEG picture discs	14
Using the menu for DVD.....	15
Checking the information	15
Program play	16

Special Functions

Angle selection.....	17
Picture zooming	17
Selecting subtitle language	17
Selecting audio language	17

Troubleshooting

18

Specifications

19

General Information

Features

- 2 channel audio out.
- Compatible with DVD, DVD+R, DVD-R, DVD+RW, DVD-RW, MP3, CD-R, CD-RW, JPEG.
- OSD menu display.
- Full function remote control.

DVD region code

DVD players and discs are designed with region numbers which dictate the region (printed on the rear panel). If the region number does not match the region number in your DVD player, you will not be able to play the disc. If you try to play the DVD, the message **WRONG REGION** will appear on the OSD.

The region number for this DVD player is **1**.

Discs that can be playbacked

- DVD discs
Multi-titles. Titles may be subdivided into chapters.
- Audio CDs and MP3
Discs are divided into tracks.



Note

- You cannot play illegally produced discs.
- You cannot play scratched discs.
- You cannot play disc that are dusty, soiled or marked with fingerprints.

Glossary of disc terms

- Title (DVD)
The longest sections of a picture or a music piece on a DVD; a movie, etc., for a picture piece on a video software; or an album, etc., for a music piece on and audio software. Each title is assigned a title number enabling you to locate the title you want.
- Chapter (DVD)
Sections of a picture or a music piece that are smaller than titles. A title is composed of several chapters. Each chapter is assigned a chapter number enabling you to locate the chapter you want. Depending on the disc, no chapters may be recorded.

Conventions about this manual

- Instructions in this manual describe the controls on the system. You can also use the controls on the remote control if they have the same or similar names as those on the system.
- The types of functions and operations that can be used for a particular disc vary depending on the features of that disc. In some cases, these functions and operations may differ from the descriptions given in this Owner's Manual. In this event, follow the instructions given on the screen. This Owner's Manual only covers basic disc operations.
- For some operations, "INVALID KEY" may appear on the screen. This indicates that the operation described in this Operations Manual is not permitted for the current disc.
- The drawings about the TV screen and front panel display used in this Owenr's Manual are purely for the purposes of explanation, the actual displays may differ slightly from what is shown here.

General Information(continued)

Notes on disc

Disc handling precautions

- To keep the disc clean, handle the disc by its edge. Do not touch the surface.
- Do not stick paper or tape on the disc.

If there is glue (or a similar substance) on the disc, remove the glue completely before using the disc.

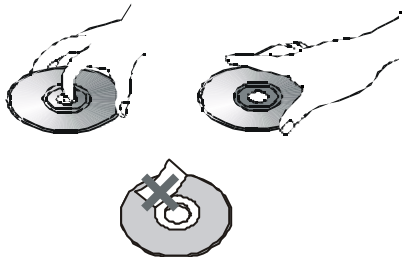

- Do not expose the disc to direct sunlight or heat sources such as hot air ducts, or leave it in a car parked in direct sunlight as a considerable rise in temperature will adversely affect the disc.
- After playing, store the disc in its case.
- Do not write on the label side with a ball-point pen or other writing implements.
- Be careful not to drop, bend, or crack the disc.

Disc cleaning precautions

- Before playing, clean the disc with a cleaning cloth. Wipe the disc from the center outward.



- Do not use solvents such as benzine, thinner, commercially available cleaners or antistatic spray intended for vinyl LPs.

Disc playing precautions

- Do not place more than one disc in the disc tray at a time.
- Do not place the disc wrong side up in the tray.
- Do not try to close the disc tray when the disc is not placed properly in the tray.

Accessories

Check that you have the following items:

- Remote Control x1
- Owner's Manual x1
- Warranty Card x1

Installing batteries in the remote control

1. Open the battery cover on the back of the remote.
2. Insert two AAA batteries, making sure that the polarities (+ and -) are aligned correctly.
3. Replace the battery cover.

You can control the system using the supplied remote. When using the remote, point it at the remote sensor on the front panel of this system.

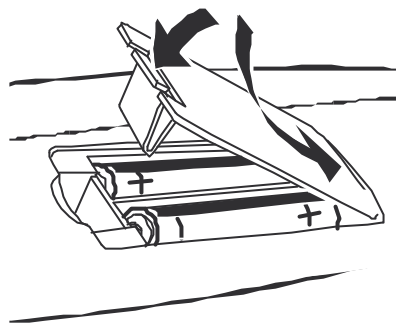

If remote doesn't operate properly:

- Check the polarity (+,-) of the batteries (Dry-Cell).
- Check if the batteries are drained.
- Check if remote sensor is blocked by obstacles.
- Check if there is any fluorescent lighting nearby.

Note:

- Do not leave the remote in an extremely hot or humid place.
- Do not use a new battery with an old one, always replace the batteries at the same time using fresh, new batteries.
- Do not drop any foreign objects into the remote casing, particularly when replacing the batteries.
- Do not expose the remote sensor to direct sunlight or lighting apparatuses, doing so may cause the remote to malfunction.
- If you do not use the remote for an extended period of time, remove the batteries to avoid any possible damage from battery leakage and erosion.

Location of Controls

Front panel

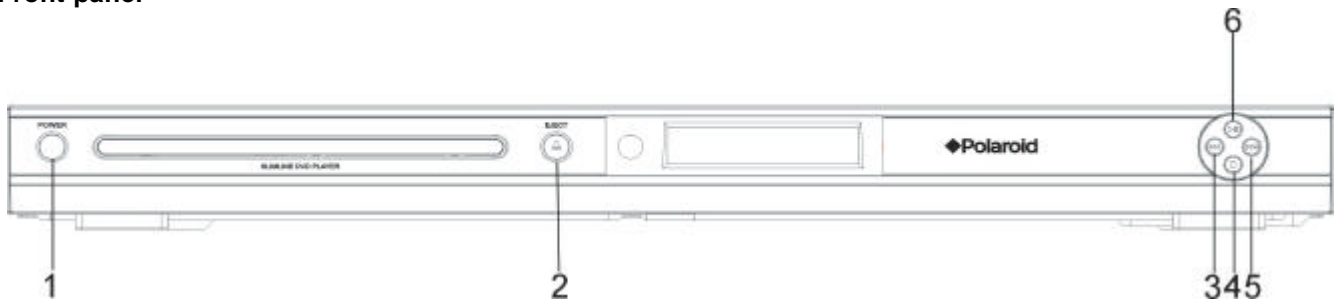

1. POWER Button : Press to switch between power on and standby mode.
2. EJECT ▲ Button : Press to open or close the disc tray.
3. PREV ◀◀ Button : Press to skip to the previous track (only during playback).
4. STOP ■ Button : Press to stop playback.
5. NEXT ▶▶ Button : Press to skip to the next track (only during playback).
6. PLAY/PAUSE ▶|| Button : Press to start or pause disc playback.

Back panel

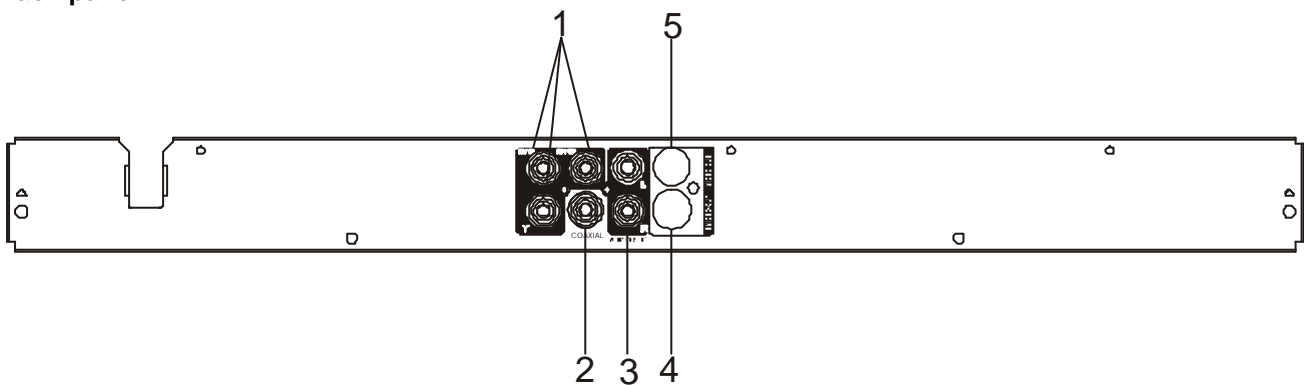

1. COMPONENT VIDEO OUT (Pr/Cr, Pb/Cb, Y) Jacks : Connect to the Pr/Pb/Y input of TV.
2. COAXIAL OUT Jack : Connect to coaxial audio input of a digital audio equipment.
3. AUDIO OUT(L/R) Jack : Connect to a TV set or stereo receiver.
4. S-VIDEO OUT Jack : Connect to the S-video input of a TV.
5. VIDEO OUT Jack: Connect to video input of a TV.

Location of Controls (continued)

Remote control

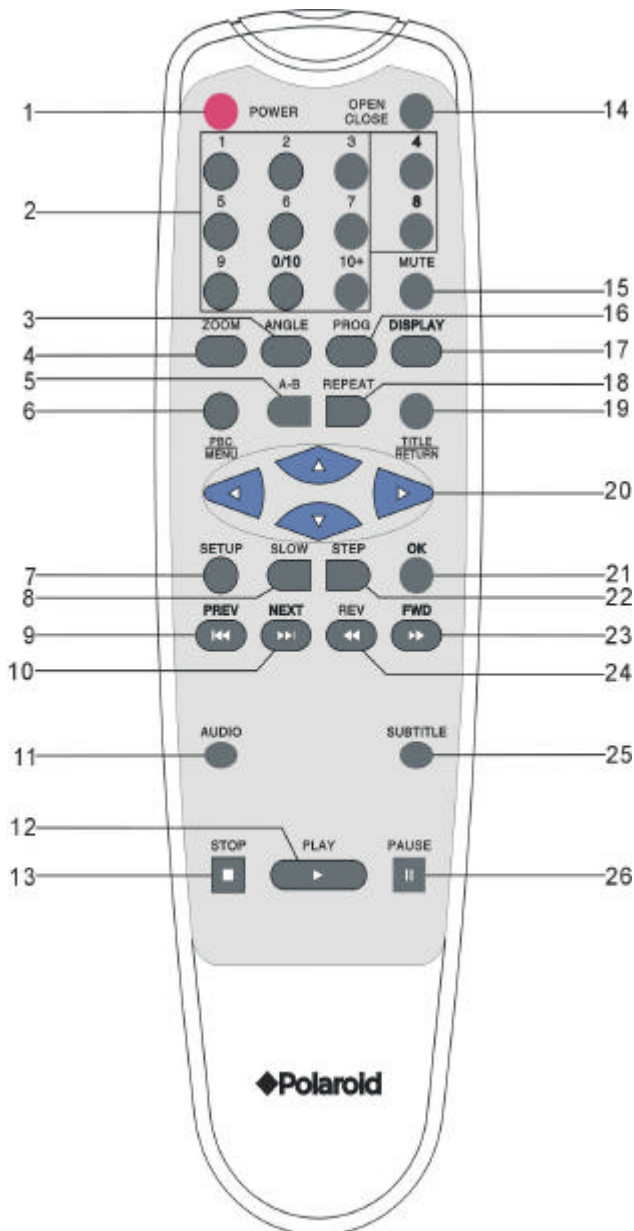

1. **POWER:** Switch the device to ON or STANDBY.
2. **NUMERICAL KEYS:** Press to select the items or settings directly.
3. **ANGLE:** Press to access various camera angles on the DVD if the DVD has multiple angle video.
4. **ZOOM:** Press to enlarge or reduce the picture.
5. **A-B:** Press to specify a section and plays it repeatedly.
6. **PBC/MENU:** Press to display the root menu when playing a DVD.
7. **SETUP:** Press to enter into the SETUP menu.
8. **SLOW:** In disc mode, press to play in slow motion.
9. **PREV:** In disc mode, press to skip to previous chapter or track.
10. **NEXT:** In disc mode, press to skip to next chapter or track.
11. **AUDIO:** Press to change the audio channels of a DVD.
12. **PLAY:** Press to start the playback.
13. **STOP:** Press to stop the playback.
14. **OPEN/CLOSE:** Press to open or close the disc tray.
15. **MUTE:** Press to turn off the sound immediately, and press again to restore the sound.
16. **PROG:** Press to program the tracks based on your own order.
17. **DISPLAY:** Press to show the information about the currently playing disc.
18. **REPEAT:** Press to repeat a title, a chapter, a song or all songs on the disc.
19. **TITLE/RETURN:** In DVD mode, press to display the title menu.
20. **DIRECTION KEYS:** Press to select the item you want.
21. **OK:** Press to enter a command or confirm a selection.
22. **STEP:** Press to view playback frame by frame.
23. **FWD:** In disc mode, press to fast forward the disc.
24. **REV:** In disc mode, press to fast reverse the disc.
25. **SUBTITLE:** Press to access various subtitle language in DVD.
26. **PAUSE:** Press to pause the playback.

Connections

IMPORTANT!

- * Before connecting the AC power cord to the wall outlet, ensure that all the other connections have been made.
- * Never make or change any connections with the power switched on.

Connecting your DVD player to your TV

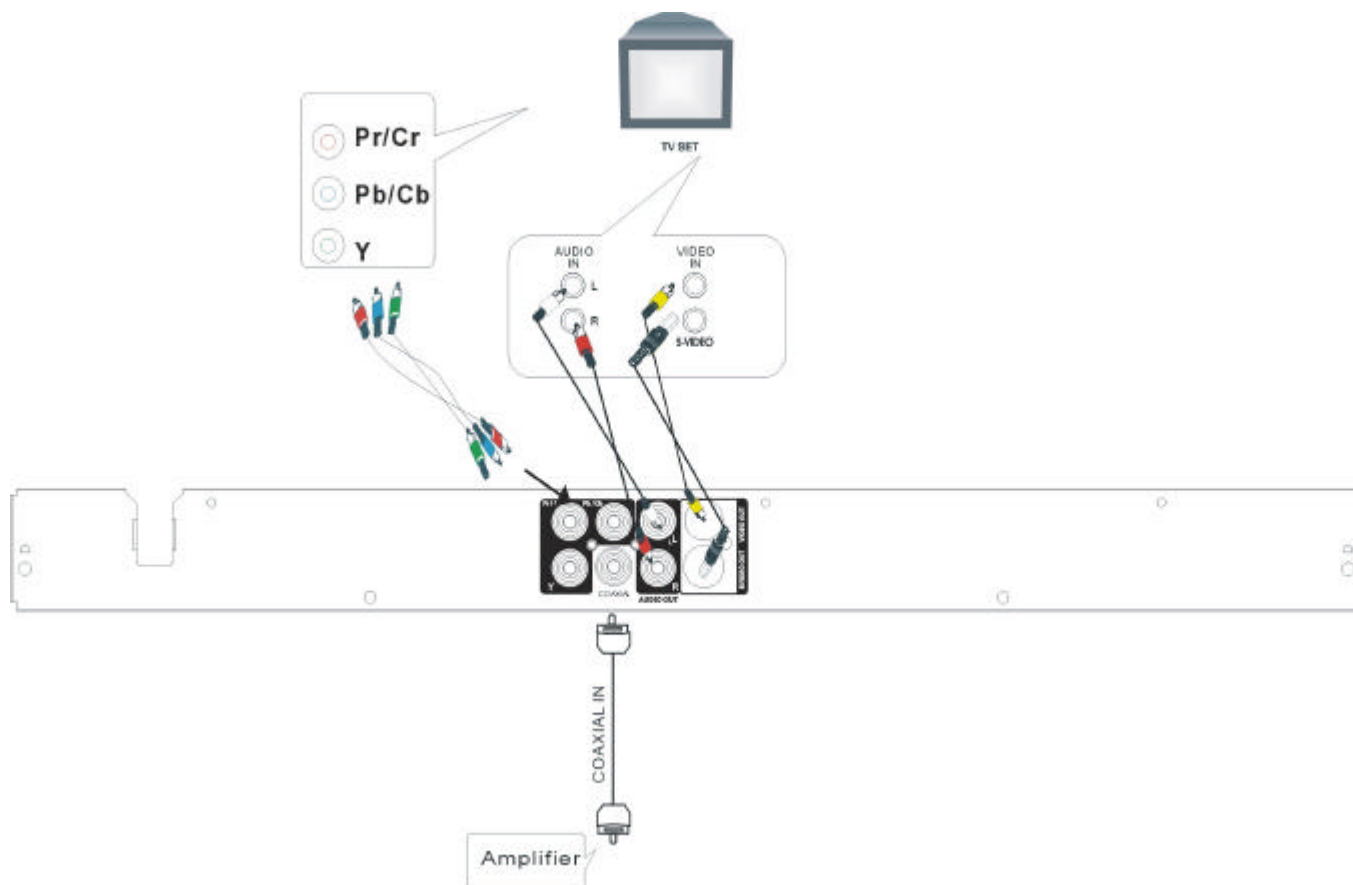

- * Connect the **S-VIDEO OUT** jack to the **S-Video** input jack on the TV using an S-Video cable.
- * Connect the **VIDEO OUT** jack to the **Video** input jack on the TV using a video cable.
- * Use the audio cables to connect the **AUDIO OUT** jacks to the corresponding **AUDIO IN** jacks on your TV, CD or TAPE recorder.
- * Use the coaxial cables to connect the **COAXIAL** jack to correspond to receive a digital signal.
- * Use the component cables to connect the **COMPONENT** jacks to get the best picture quality.

Basic Setup

SETUP MENU

In top menu move the highlight to Setup menu to set below settings desired.

- **SYSTEM SETUP**
- **LANGUAGE SETUP**
- **AUDIO SETUP**
- **VIDEO SETUP**

SYSTEM SETUP

The system setup is carried out via the TV, enabling you to customize the DVD system to suit your particular requirements. If the preferred options selected are not available on a disc, then the disc's default settings will be used.

1. Press **SETUP** on remote control.
2. Use **◀/▶/▲/▼** to select the item you want.
3. Press **OK** to confirm the selection.
4. To exit the setup, press **SETUP** again.

This page includes:

- TV SYSTEM
- TV TYPE
- SCREEN SAVER
- DEFAULT

TV SYSTEM

You can setup the color system of this unit to match your connected TV set. If the color system of this unit is different from that of the TV set, the images will not be displayed normally on the screen.

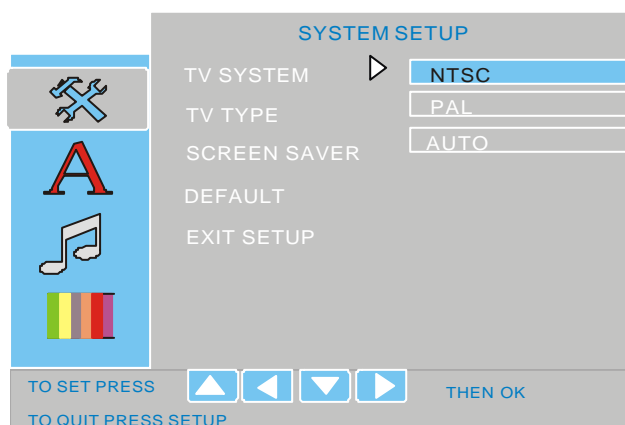

TV TYPE

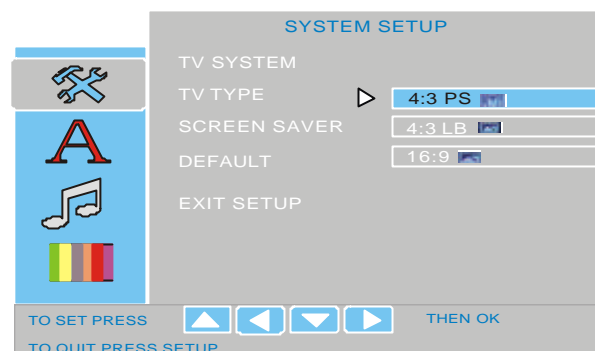

- **4:3 PS**
If you have a conventional TV set and your DVD is not formatted for widescreen viewing, use this setting. A wide picture is displayed on the whole TV screen with a portion automatically cut off.
- **4:3 LB**
If you have a conventional TV set and your DVD is formatted for widescreen viewing, use this setting. Wide bands will be displayed on the upper and lower portions of the TV screen.
- **16:9**
If you have a widescreen TV set, use this setting (you must also set your widescreen TV to Full size).

SCREEN SAVER

The default setting for the SCREEN SAVER is ON. The screen saver image appears when you leave the system in stop mode for about 5 minutes.

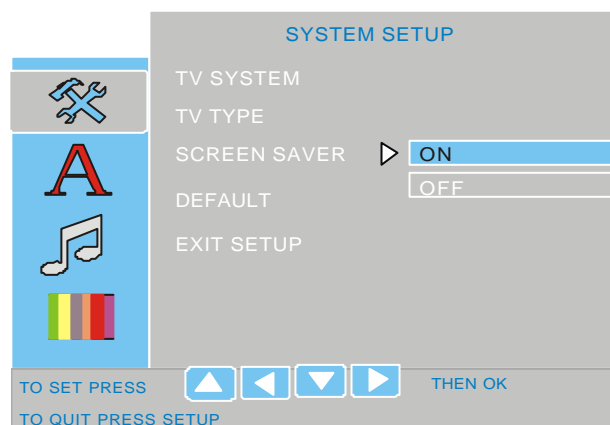

Basic Setup(continued)

DEFAULT

If you select this function, all of the functions will restore to the original settings.

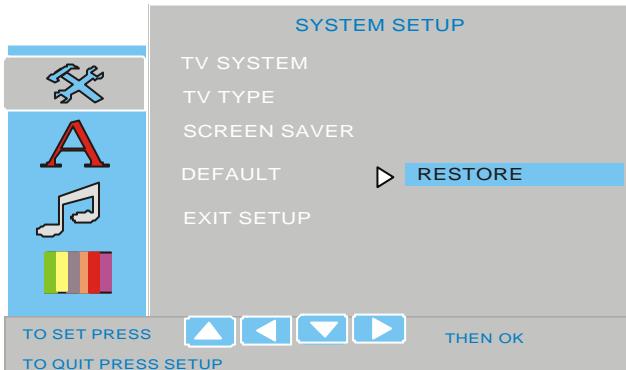

LANGUAGE SETUP

1. Press **SETUP** on the remote control.
2. Use **◀/▶/▲/▼** to select item you want.
3. Press **OK** to confirm the selection.
4. To exit the setup, press **SETUP** again.

This section includes:

- OSD LANGUAGE
- AUDIO LANG
- SUBTITLE LANG
- MENU LANG

OSD LANGUAGE

- ENGLISH
- SPANISH
- FRENCH

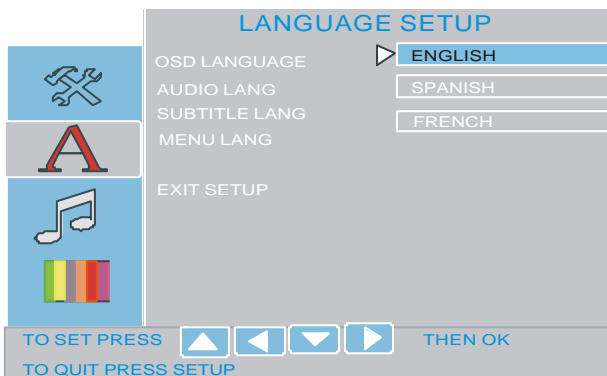

AUDIO LANG, MENU LANG

This function allows you to select the desired language. It includes:

- ENGLISH
- JAPANESE
- FRENCH
- SPANISH
- PORTUGUESE
- GERMAN

The default setting is ENGLISH.

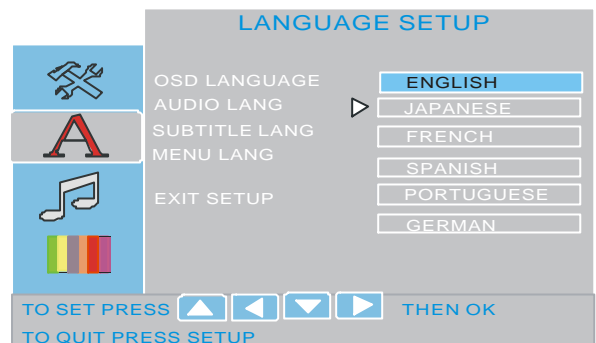

Basic Setup(continued)

SUBTITLE LANG

This function allows you to select the desired language. It includes:

- ENGLISH
- JAPANESE
- FRENCH
- SPANISH
- PORTUGUESE
- GERMAN
- OFF

The default setting is OFF.

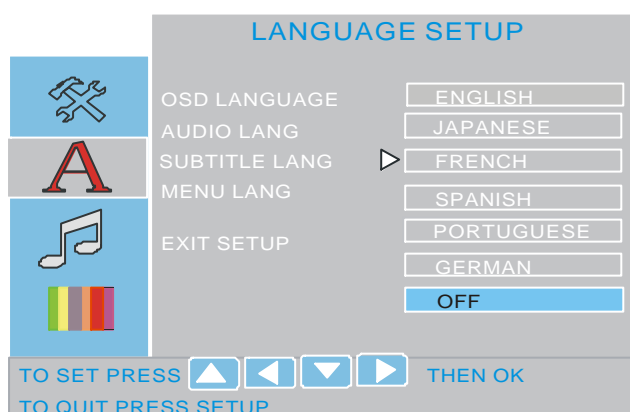

AUDIO SETUP

1. Press **SETUP** on the remote control.
2. Use **◀▶/▲▼** to select the item you want.
3. Press **OK** to confirm the selection.
4. To exit the setup, press **SETUP** again.

This section includes:

- DIGITAL OUT
- DOWN SAMPLE
- DOWNMIX

DIGITAL OUT

The default setting is **RAW**.

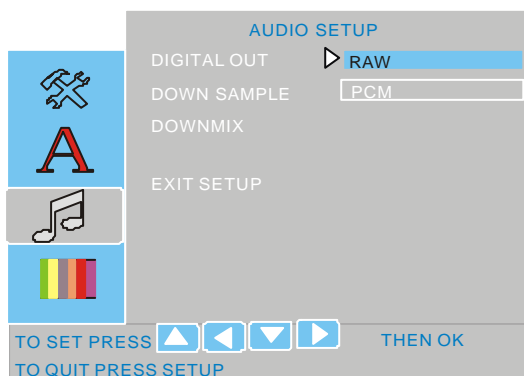

DOWN SAMPLE

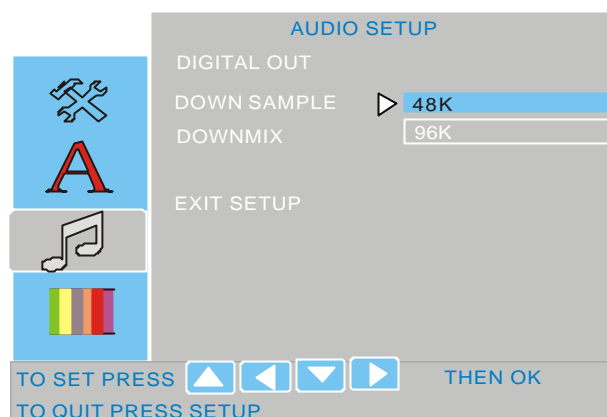

DOWN MIX

To play a DVD disc recorded with surround multi-channel audio correctly. Select the appropriate setting according to your audio system.

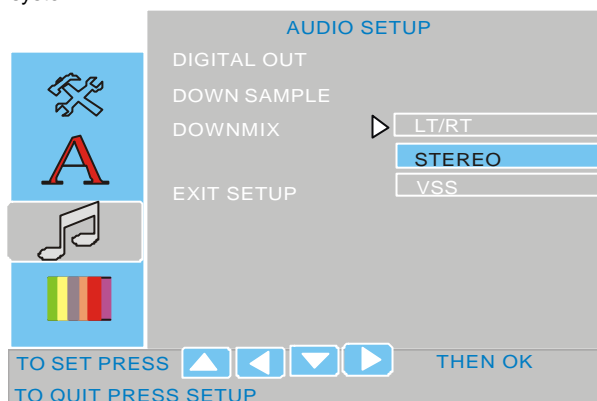

- **LT/RT**
When the disc you played has **PRO LOGIC** stereo function, you can select this.
- **STEREO**
2-channel stereo output, for stereo listening through the analog left and right outputs.
- **VSS**
2-channel virtual surround outputs.

Note:

Depending on the disc, the actual outputs may not match your selection.

Basic Setup(continued)

VIDEO SETUP

1. Press **SETUP** on the remote control.
2. Use **◀/▶/▲/▼** to select item you want.
3. Press **OK** to confirm the selection.
4. To exit the setup, press **SETUP** again.

This section includes:

- BRIGHTNESS
- CONTRAST
- HUE
- SATURATION
- VIDEO OUT

BRIGHTNESS, CONTRAST, SATURATION

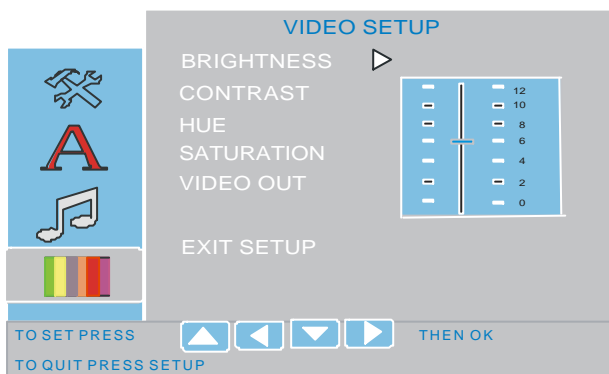

The **BRIGHTNESS**, **CONTRAST**, and **SATURATION** are the same User Interface. The default setting for the **BRIGHTNESS** and the **CONTRAST** is **6**; the default setting for **SATURATION** is **0**.

HUE

The default setting is **0**.

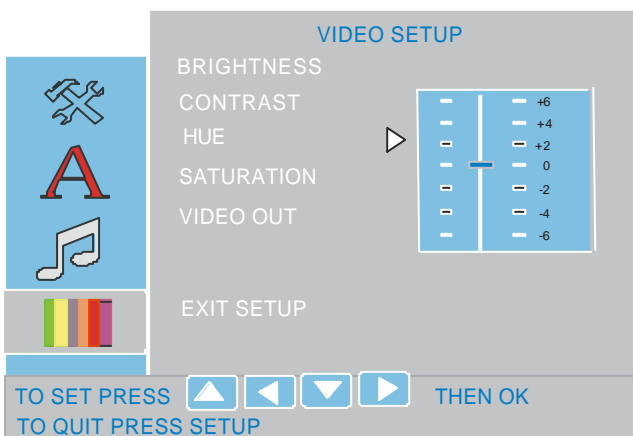

VIDEO OUT

- YUV
- S-VIDEO
- P-SCAN

P-SCAN

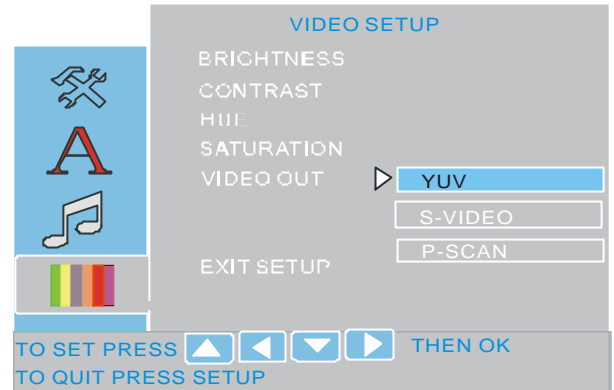

The default setting for the **P-SCAN** is **OFF**. If you set it **ON** and your TV support this function then it will appear as follows.



If you select **OK**, it will appear as below.



Playing Discs

General operation

- 1 After all the connections are properly completed, plug the AC power cord of the player to an appropriate wall outlet.
- 2 Press **POWER** to turn **ON** the main power.
- 3 Press **OPEN/CLOSE** on the remote control or **EJECT** on the front panel to open the disc tray, press again to close the disc tray.
- 4 Press **MUTE** to shut off the sound. To restore the volume, press **MUTE** again.

Basic playback

Start playback

- Press **PLAY** ► to start playback, to pause playback, press **PAUSE** II.

Note

- Some discs will start playing automatically, and others will display the menu on the TV screen. use the ◀/▶/▲/▼ buttons to select the track, or press the number keys (0/10~ 9,10+) to go to the desired track/chapter.

Stop playback

- Press **STOP** ■.

Skip to another track/chapter

- Press I◀◀/▶▶I repeatedly during playback to skip to the next or previous track/chapter.

Fast search

- 1 Press and hold ◀◀/▶▶ for more than 1 second to fast reverse or fast forward.
 - **For DVD/MP3/CD discs**
FF (fast forward) : FF x2, FF x4, FF x8, FF x20.
FR (fast reverse) : FR x2, FR x4, FR x8, FR x20.
- 2 To resume normal play, press **PLAY** ►.

Press **SLOW** to play the currently playing disc in slow motion.

For DVD discs

Press it repeatedly to select the slow motion speed:
SF (slow forward) : SF 1/2, SF 1/4, SF 1/6, **PLAY**

Repeat

1. For DVD discs

Press **REPEAT** repeatedly to select the following:

REP : [OFF]



REP : [CHAPTER]



REP: [TITLE]



REP: [REP ALL]

2. For CD discs

Press **REPEAT** repeatedly to select the following.

REP : [OFF]



REP : [REP 1]



REP: [REP ALL]

3. For MP3 discs

Press **REPEAT** repeatedly to select the following.

REP : [OFF]



REP : [REP 1]



REP: [REP DIR]



REP: [REP ALL]

Playing MP3/JPEG picture discs

1. Load an MP3/JPEG disc.
2. Playback should start automatically, if it does not, then press the **PLAY** ► button to start playback.
3. Press I◀◀/▶▶I to select the previous or next track.
4. While in stop mode , press ◀/▶/▲/▼ button to select a desired album title , then press the **PLAY** ► button to start playback.
5. To stop playback , press **STOP** ■.



Playing Discs(continued)

Using the menu for DVD

- 1 Press **PBC/MENU** while playing a DVD disc.
The TITLE MENU will appear on the TV screen. The contents of the menu vary from disc to disc.
- 2 Use the **◀/▶ / ▲/▼** buttons to select the title (or chapter) you want to play.
Depending on the disc, you can use the number buttons (**0/10~9,10+**) to select the title (or chapter).
- 3 Press **OK** to start playback.
- 4 To change other items, repeat Step 1 ~ 2.

Note:

- Depending on the DVD disc, you may not be able to select the title or chapter.
- Depending on the DVD disc, a title menu may simply be called a menu or root menu in the instructions supplied with the disc.
- For some DVD discs, when you press the **PBC/MENU** button, the playback will restart from the beginning of the disc.

Checking the information

You can check information about the disc, such as the total number of the titles or chapters or tracks or time, using the display function. The information you want will appear on the TV screen.

When playing a DVD

- 1 Press **DISPLAY** repeatedly to show the following (for reference only):

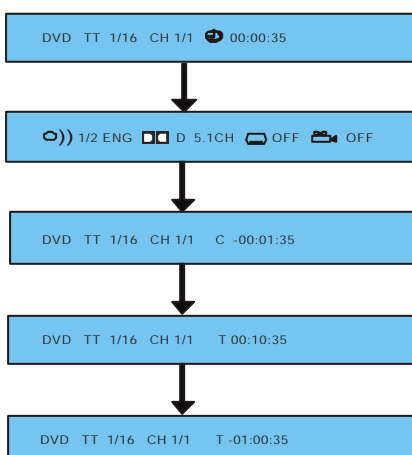

- 2 Press **DISPLAY** again, and the information will disappear.

When playing back a CD

- 1 Press **DISPLAY** repeatedly to show the following (for reference only):

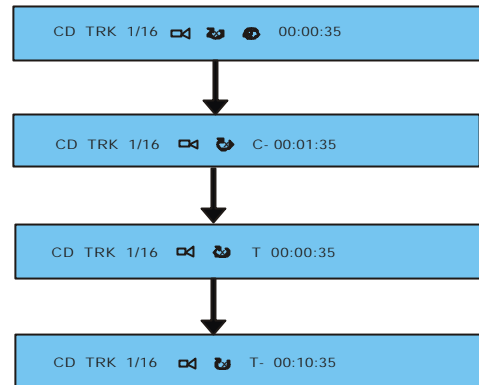

- 2 Press **DISPLAY** again, the information will disappear.

Playing Discs(continued)

Program play

You can play the contents of the disc in a specific order by programming the order of the tracks to be played.

- 1 While playback is stopped, select or press **PROG** to enter the program mode.
- 2 Use the number buttons (**0/10 ~ 9,10+**) to input the track numbers in the order you want.
- 3 Repeat step 2 to store other tracks.
- 4 To start program play, press **PLAY ▶**.
- 5 To stop playback, press **■** once.
- 6 To cancel the program, press **CLEAR** on the display image again.

For DVD disc

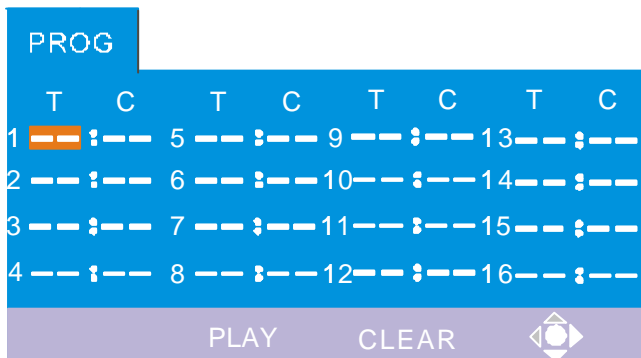

For CD disc

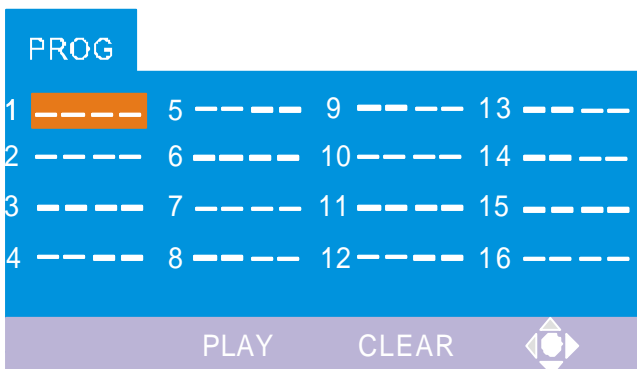

Special Functions

Angle selection

Some DVD discs contain scenes which have been shot simultaneously from a number of different angles. For these discs, the same scenes can be viewed from each of the different angles.

- 1 Press the **ANGLE** button to change the scenes from one angle to other angle(s).
For example: 1/4, 2/4, 3/4, 4/4.

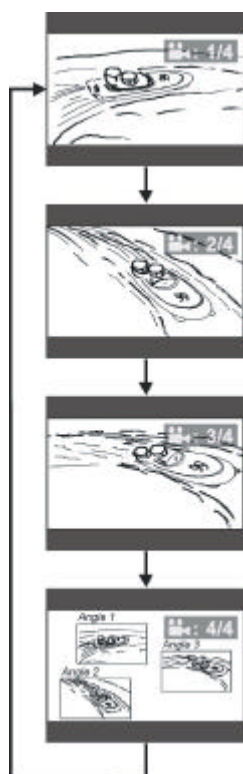

Picture zooming

This function allows you to enlarge the picture on the TV screen and to pan through the enlarged image.

- 1 Press **ZOOM** repeatedly to select a zoom factor as below:

ZOOM 2
↓
ZOOM 3
↓
ZOOM 4
↓
ZOOM 1/2
↓
ZOOM: OFF

- 2 To pan through the enlarged image, press ◀/▶/▲/▼ buttons to move the zoomed picture left, right, up or down.

Selecting subtitle language

This function can only be used for DVD disc recorded with multi-subtitle language.

Press **SUBTITLE** repeatedly to select a desired language.

Note

- The first pressing shows the current selection. Subsequent pressing toggles to the next subtitle setting.
- During some scenes, the subtitles may not appear immediately after you turn them on.

Selecting audio language

Depending on some DVD discs, you may be able to change the audio format (including audio coding type, number of channels recorded and audio language) using **AUDIO** button.

Troubleshooting

If you experience any of the following difficulties while using the system, use this troubleshooting guide to help you remedy the problem. Should any problem persist, please call tech support listed on the warranty.

No power

- Is the power cord firmly plugged into the power outlet?
- One of the safety mechanisms may be operating. In this event, unplug the player from the power outlet briefly and then plug it in again.

No picture

- Check that the system's cables are connected securely.
- The video connecting cord is damaged. Replace it with a new one.
- Make sure you connect the system to the video input connector on your TV.
- Make sure you turn on the TV.
- Make sure you select the video input on the TV so that you can view the pictures from this system.

The picture quality is low

- Clean the disc.
- If video from this system has to go through your VCR to get to your TV, the copy-protection applied to some DVD programs could affect picture quality. If you still experience problems after checking your connections, please try connecting your DVD system directly to your TV's S-Video input, if your TV is equipped with this input.

The aspect ratio of the screen cannot be changed even though you set TV TYPE in the SETUP menu when you play a wide picture.

- The aspect ratio is fixed on your DVD disc.
- If you connect the system with the S-Video cable, connect directly to the TV. Otherwise, you may not be able to change the aspect ratio.
- Depending on the TV, you may not be able to change the aspect ratio.

There is no sound or only a very low-level sound is heard.

- The system is in pause mode, in slow-motion play mode, or fast forward or fast reverse is performed. Press ► to return to normal play mode.
- Make sure that the audio cable is connected securely.

External noise is heard

- Check that the connecting cords are away from a transformer or motor.
- Move your TV away from the audio components.
- The plugs and jacks may be dirty. Wipe them with a cloth slightly dampened with alcohol.
- Clean the disc.

The sound loses stereo effect when you play CD

- Set the Audio mode to **STEREO** in the **SETUP** menu.
- Make sure you connect the system cables appropriately.

The surround effect is difficult to hear when you are playing a Dolby Digital sound track

- Depending on the DVD disc, the output signal may not be the entire 5.1 channel but may be monaural or stereo even if the sound track is recorded in Dolby Digital format.

The language for the subtitles cannot be changed when you play a DVD

- Multilingual subtitles are not recorded on the DVD.
- Changing the language for the subtitles may be prohibited on the DVD.

The subtitles cannot be turned off when you play a DVD

- Depending on the DVD, you may not be able to turn the subtitles off.

The angles cannot be changed when you play a DVD

- Multi-angles are not recorded on the DVD.
- Make sure to change the angles when the angle mark appears on the TV screen.
- Changing the angles may be prohibited on the DVD.

The system does not operate properly

- Static electricity, etc., may affect the system's operation. Press the **POWER** button to turn the unit off, wait one minute, then press again to turn the unit back on.

Specifications

DVD section

Laser type	Semiconductor laser, Wavelength 650 nm
Signal system	PAL625/50,NTSC525/60
Video output level	1 Vp-p (75 ohm)
Video Y output level	714 Vp-p (75 ohm)
Video C output level	286 mVp-p (75 ohm)

Digital output Coaxial

Video signal

Horizontal resolution: 480lines

S/N ratio: 60dB

Audio signal

Audio frequency response DVD (PCM)20 Hz - 22 kHz (+/-1.0 dB)
CD 20 Hz - 20 kHz (+/-1.0dB)

S/N ratio 80dB

Dynamic range: DVD(PCM): 85dB
CD: 85dB

Audio L/R : 2V 1K Hz 0dB

Distortion 0.1%

General

Power supply 120V~60Hz

Power consumption 15W

*Specifications subject to change without prior notice.

For service, support and warranty information, visit www.polaroid.com or in the US call 1-866-289-5168, in Canada call 1-866-301-7922 and in Mexico call 01-800-400-2443.

"Polaroid" and "Polaroid and Pixel" are registered trademarks of the Polaroid Corporation.