

GPS105

Operating Manual

&

Quick Start
Guide



GPS Transceiver
with an
Integrated
UHF Radio



Uniden®

To bring outstanding wireless communication products
to people's lives throughout the world.

WARNINGS & NOTIFICATIONS



When using the GPS105 in a motor vehicle it is the user's responsibility to ensure operating the GPS105 does not detract from the safe operation of the vehicle.



For safety reasons it is not recommended that a driver change any settings while in motion. Please come to a complete stop or have a passenger make changes if necessary.



The latitude, longitude, and altitude indications on the display are based on WGS-84 Datum, and the altitude indication may not appear depending on the signal conditions from GPS satellites.



The compass heading (directional pointer) shown on the display is referenced to the GPS105's last forward movement. When viewing the compass heading the GPS105 must be facing in the direction of the last forward movement in order to read the compass heading correctly.



GPS signal reception can be affected by the location of satellites, tall buildings, tunnels, bridges, etc. If the GPS105 is not receiving a signal, you will need to change your location until a signal is received.



The Global Positioning System is operated and maintained by the US Government. The US Government is completely responsible for the accuracy of the Global Positioning System.



The US Government reserves the right to make changes to the Global Positioning System in accordance with the Department of Defence civil GPS user policy and the Federal Radio navigation plan. These changes along with poor satellite geometry could cause inaccurate readings.

Quick Start Guide

Start Here! **1** **2** **3**

The Quick Start Guide pages are designed to allow you to install and operate your GPS105 as quickly as possible, however it does not attempt to explain any of the advanced features of the GPS105 unit.

1 **INSTALLING YOUR GPS105**

Please consider the following before installing.

The GPS105 is designed to fit into a standard car stereo (DIN) fitting.

You may also use the supplied bracket & fasteners to mount the GPS105 in other locations.

The GPS105 uses a UHF antenna and a GPS internal antenna.

For a UHF antenna (not supplied) please follow the manufacturers instructions for installation.

It is recommended that the UHF and GPS antenna are mounted separately.

- If placing the GPS internal antenna on the dashboard or the rear parcel shelf then ensure the UHF antenna is fitted towards the opposite end of the vehicle or fitted centre of the roof top.



- *The GPS105 runs on positive 13.8V DC, negative earth.*
- *The positive wire is fused at 2 Amps.*



With some vehicles, the window tint may prevent the GPS Internal Antenna from acquiring a signal. In such a case, an optional External GPS antenna may be used.

2 CONNECTING YOUR GPS105

BACK PANEL

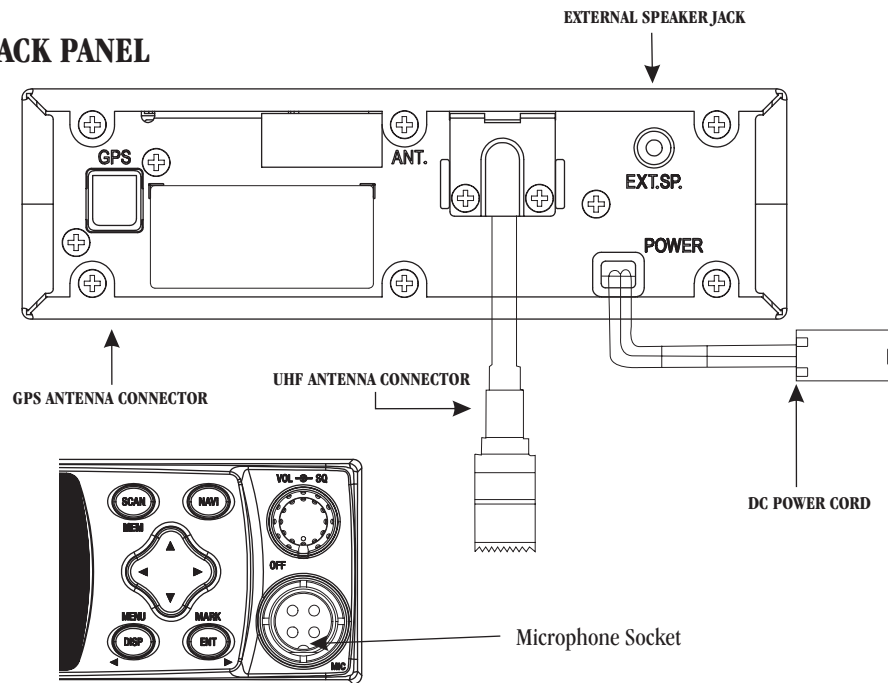

- i. Remove fuse from fuse holder along power lead.
- ii. Connect 13.8V supply to the power lead making sure positive is applied to the red wire and ground to the black wire.
- iii. Connect the UHF Antenna with PL259 fitting (not included).
- iv. Connect the GPS Internal Antenna.
- v. Make sure the Power Switch knob is OFF (see Controls page 4).
- vi. Re-insert the fuse into the fuse holder.
- vii. Connect microphone plug to microphone socket.



An optional External Speaker may be connected via the External Speaker Jack. When the external speaker is connected the internal speaker is automatically disconnected. The connecting wire must use a 3.5mm miniature plug.

3 TEST FOR A GPS SIGNAL

- i. Turn the GPS105 ON.
- ii. The Welcome display will appear.



- iii. After 3 seconds the initial display will switch to the UHF-CB display.
- iv. At the top of the display the unit will indicate it is searching for satellite information.



Make sure the GPS antenna has an unobstructed view of the sky.



For the initial power up it may take up to 15 minutes to secure satellite information. When satellite data has been retrieved 'SEARCHING FOR SATELLITE' will disappear and 'GPS' will show at the top of the display.



If the unit continues to indicate searching for satellite beyond 15 minutes try holding the GPS Internal Antenna outside of the vehicle. If satellite data is then retrieved and 'GPS' appears then the vehicle windscreen may have a tint which interferes with the GPS signal. An optional External GPS Antenna may be fitted.

In this case an external GPS Antenna may be used in place of the internal antenna.

- v. Turn OFF the unit and replace the GPS antenna if required and repeat steps i to iv.
- vi. Secure all fittings.

4 SETTING USER NAME

You may personalize your GPS105 by setting a User name which will appear at the top of the display. The User name also forms part of your call ID when communicating to radios using similar technology (GPS105 or GPS205) on channel 22 or 23.

To set your Username:



- i. Press & hold **MENU** to bring up the menu list.
- ii. Press **▼** and scroll down until USER NAME is highlighted.
- iii. Press **ENT**.
- iv. Enter Name:
Press **▲** or **▼** to select desired character.
Press **◀** or **▶** to move to previous or next character.
- v. Press **ENT** to confirm.



- Username cannot include blank spaces.
- The user name may be up to 12 characters long.

5 SEND POSITION ON

The SEND POSITION function enables the GPS105 to transmit your User name and position on channels 22 and 23.
The factory setting for this feature is OFF.



Current regulations permit enabling the SEND POSITION function to operate on Channels 22 and 23 only. The SEND POSITION will be OFF from the factory.

To turn SEND POSITION ON:

- i. Press & hold **MENU** to bring up the menu list.
- ii. Scroll **▼** to highlight SENDPOSITION.
- iii. Press **ENT**.

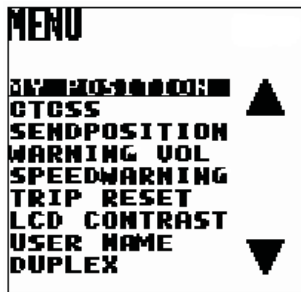

- iv. Press **▲** to select ON.
- v. Press **ENT** to confirm setting.

End of
Quick Start
Guide **1 2 3**

CONTENTS

Warnings & Notifications.....	i
Quick Start Guide.....	ii
Installing Your GPS105.....	ii
Connecting Your GPS105.....	iii
Test For A GPS Signal.....	iv
Setting User Name.....	v
Send Position ON.....	vi
Contents.....	1
Introduction.....	3
Features.....	3
Controls.....	4
Indicators.....	5
Included With Your GPS105.....	6
UHF-CB Operation.....	7
Setting The Squelch.....	7
Selecting A Channel.....	8
To Transmit And Receive.....	8
To Operate In Duplex Mode (Repeaters).....	9
Scanning with Priority Channel.....	10
Scanning - Scan Memory.....	10
Reply Delay.....	10
Instant Channel.....	11
CTCSS (Continuous Tone Coded Squelch System).....	11
BCLO (Busy Channel Lock Out) Feature.....	11
Key Beep ON/OFF.....	12
Roger Beep.....	12

CONTENTS

GPS Operation.....	13
Speed Warning.....	13
Early Warning Safety Alerts.....	14
Warning Volume.....	14
Caller Display.....	15
CALLER ID Memories.....	15
To Store The Caller Into MY POI.....	15
Mark Location.....	16
Quick Access Locations.....	16
MY POI Locations.....	17
Edit/Delete MY POI.....	18
Add Or Delete Safety Alert.....	19
Navigation.....	20
Navigate To Quick Access.....	21
Navigate To CALLER.....	21
Navigate To MY POI.....	22
Navigate To STATE/CITY.....	23
TRIP Computer.....	24
To Reset TRIP Computer.....	24
My Position.....	25
LCD Contrast.....	25
UHF Channels & Frequencies.....	26
CTCSS Tone List.....	26
Troubleshooting.....	27
Warranty.....	28

INTRODUCTION

The Uniden GPS105 is designed to provide you with years of trouble free service. It's rugged components and materials are capable of withstanding harsh environments.

We are certain that you will enjoy your GPS105. Please read this operating Manual carefully to ensure you gain the optimum performance of the unit.

FEATURES

- Backlit LCD Display
- Key Beep ON/OFF

GPS FUNCTIONS

- Navigation to pre-programmed Australian and New Zealand cities and suburbs
- Mark and delete up to 500 of your own locations
- Fixed Speed Camera Warning
- Red Light Camera Warning
- Black Spot Warning
- My Position Display
- 20 Caller ID Memories*
- Trip Computer

UHF-CB

- Transmit & Receive on 40 UHF channels
- Duplex capability
- Scan with Priority CH Watch
- Scan Memory ON/OFF
- Roger Beep ON/OFF
- BCLO (Busy Channel Lock Out) Function
- Send, Receive and Navigate your Position with GPS CALLER ID*
- 38 Built in CTCSS (Continuous Tone Coded Squelch System) Codes
- Selectable INSTANT Channel

* To benefit from these features, transmission needs to be with another compatible Uniden GPS product (GPS105 or GPS205) on channel 22 or 23.

CONTROLS

GPS105

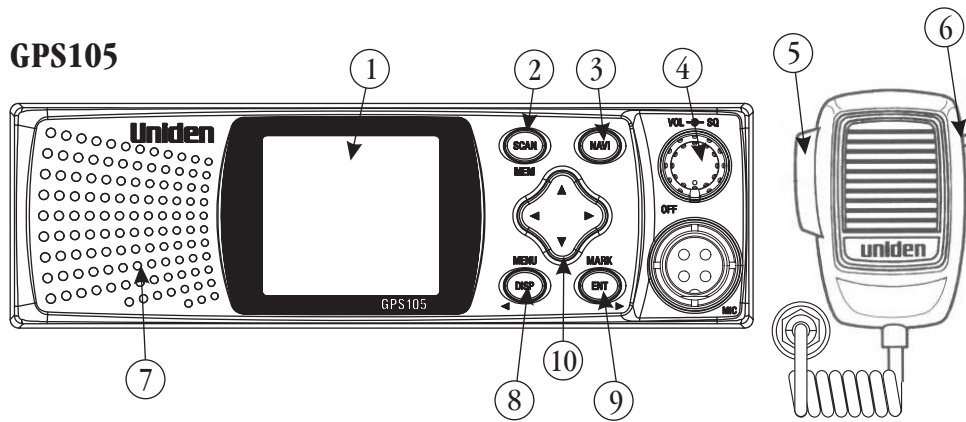

1. LCD Display
2. **SCAN** /MEM - Scan Key/Memory Key
3. **NAVI** - Navigation Key
4. VOL/SQ - Centre Knob (Power-VOLUME): Turns the Power ON/OFF and adjusts the Volume.
Outer Ring (SQUELCH): Adjusts the Squelch
5. PTT - Push to Talk(PTT) switch
6. Channel Instant - Instant Channel switch
7. Speaker
8. **DISP** /MENU/◀ - Display key/ Menu key/ Back to previous Display key
9. **ENT** /MARK/▶ - Enter key/ Mark key/ Move to next Display key
10. SCROLL - ▲ up, ▼ down, ◀ left, ▶ right keys or 

INDICATORS

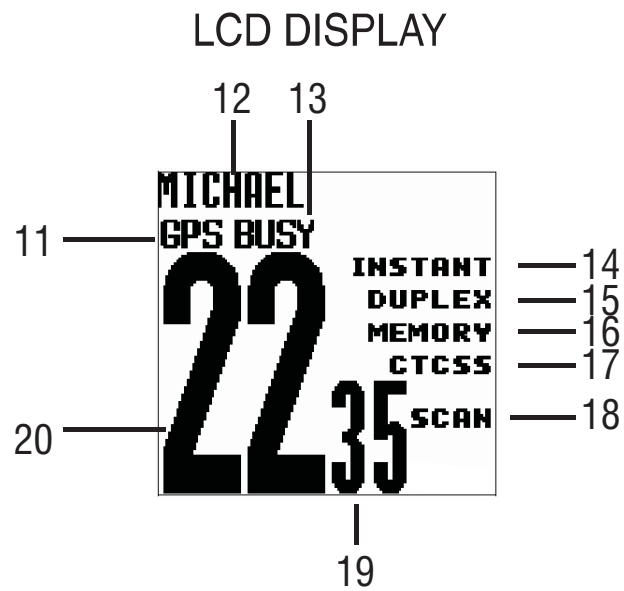

UHF-CB Display

- | | |
|--|----------------------------|
| 11 GPS - GPS status icon | 16 MEMORY icon |
| 12 USER NAME - An example (MICHAEL) is shown | 17 CTCSS icon |
| 13 BUSY - Receive icon | 18 SCAN icon |
| 14 INSTANT - Channel Instant icon | 19 CTCSS Channel indicator |
| 15 DUPLEX icon | 20 Channel indicator |

INCLUDED WITH YOUR GPS105

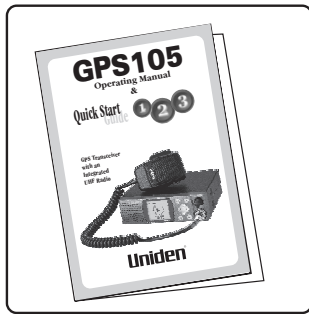

GPS105 Owners Manual

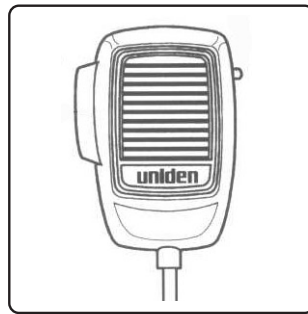

Microphone

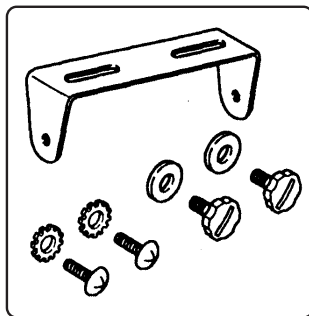

Mounting Bracket, Knobs, Rubber washer, Washer Stars and Screws.

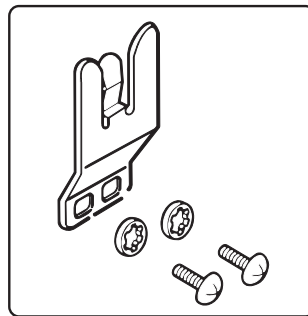

Microphone Hanger Screws and washers

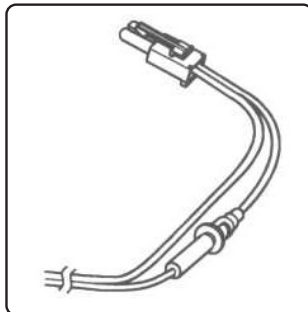

DC Power Cord with fuse

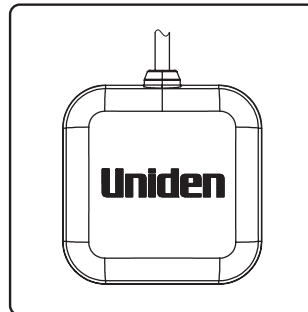

GPS Internal Antenna



If any of these items are missing from the box, contact your dealer immediately.

UHF CB - OPERATION

All UHF-CB functions are only available when in UHF-CB mode.

SETTING THE SQUELCH

1. To turn the unit ON, rotate VOL knob clockwise. Adjust volume to a comfortable level.

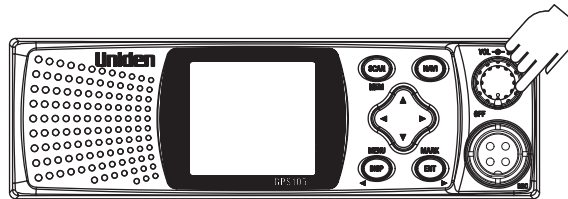

2. Think of the Squelch control as a gate. If you turn SQUELCH fully clockwise it raises the "Squelch Gate" so that no signals get through.

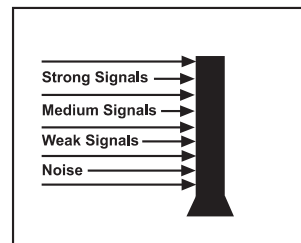

3. If you turn the SQUELCH fully counter clockwise, it lowers the "Squelch Gate" so that everything gets through - noise, weak signals and strong signals.

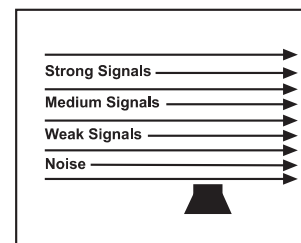

4. To set the "Squelch Gate" to the desired level, turn SQUELCH counter clockwise until you hear noise. Then turn the SQUELCH clockwise just until the noise stops. Now only strong and medium signals get through.

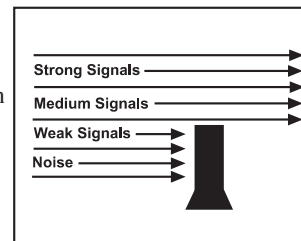

UHF CB - OPERATION

SELECTING A CHANNEL

The GPS 105 uses the 40 UHF-CB Channels. For your reference a list of the available channels and corresponding frequencies is printed on page 26.

To select a desired channel in UHF-CB Mode:

1. Press ▲ or ▼ momentarily to step up or down a channel.
2. Press and hold ▲ or ▼ to rapidly step up or down channels.

TO TRANSMIT AND RECEIVE

1. Before you transmit, listen for activity on the selected channel.
2. When the channel is clear, press and hold the PTT to transmit. 'TX' will flash on the LCD.
3. Hold the microphone approximately 5 cm in front of your mouth. Speak in a clear, normal conversational voice.
4. When you have finished speaking, release the PTT and listen for a response. 'TX' then disappears on the LCD. While receiving, the 'BUSY' icon will flash on the display.



Transmit will not occur if: The unit detects that the channel is busy when using the CTCSS function with BCLO (page11).

UHF CB - OPERATION

TO OPERATE IN DUPLEX MODE (REPEATERS)

The Duplex function enables you to access local repeater stations. You can only activate Duplex from CH01-CH08.

UHF CB Repeaters are used to retransmit or relay your signal.

Repeaters will extend the range of your radio and overcome the shielding effect caused by solid obstructions.



Contact a retailer for a list of repeaters available in your area.

Operation with the aid of a Repeater

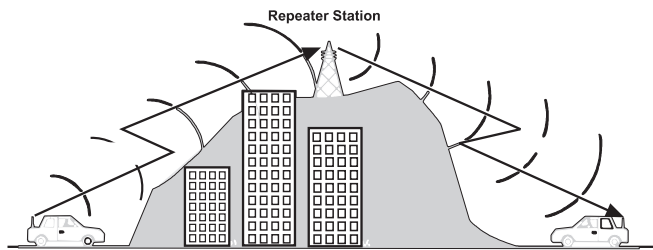

To turn DUPLEX ON/OFF:

1. Select the channel of the repeater in your area (CH01 - CH08).
2. Press & hold **MENU**.
3. Scroll **▼** to highlight DUPLEX.
4. Press **ENT**.
5. Press **▲** or **▼** to select ON or OFF as desired.
6. Press **ENT** to confirm selection.
'DUPLEX' will appear when a duplex channel is used only if duplex is turned ON.



If DUPLEX is selected from the MENU options when the channel is not from CH01 - CH08, an error tone sounds.

UHF CB - OPERATION

SCANNING with PRIORITY CHANNEL

The scan function scans channels that are in the scan memory and stops at an active channel. Whichever channel you have selected when SCAN begins becomes the Priority Channel. SCAN will check the priority channel every 1.5 seconds.

To initiate scanning:

1. Press **SCAN** momentarily to begin scanning. The SCAN icon flashes on the display.
2. Press PTT, INSTANT or any function key to cancel SCAN.

If SCAN is cancelled while stopped on a busy channel that channel will be the exit channel.

If SCAN is cancelled while scanning then the unit will exit to the priority channel which is the current channel when SCAN is turned ON.

SCANNING - SCAN MEMORY

You can only scan channels which are currently in the scan memory. By default all channels are active in the scan memory.

To add or remove channels from the scan memory:

1. Select a channel using scroll **▲** or **▼**.
2. Press and hold **MEM**.

REPLY DELAY

While scanning, the GPS105 stops at a busy channel and receives a transmission.



When the received signal is over, the unit will wait for 3 seconds for the return of the signal, otherwise the radio resumes scanning.

UHF CB - OPERATION

INSTANT CHANNEL

The Instant Channel feature enables a chosen channel to be called at the press of a button. Only one channel at a time is designated as the Instant Channel.

To register or change the Instant channel:

1. Select a channel using scroll  or .
2. Press and hold the Instant Channel button. 'INSTANT' will appear on the UHF-CB display for the channel selected.







To use Instant Channel:

Press the Instant Channel button momentarily when in the UHF-CB mode to instantly change to the Instant channel and that channel will be automatically called.

CTCSS (Continuous Tone Coded Squelch System)

CTCSS is a feature that allows a group to talk to each other without hearing other users on the same channel.

To activate CTCSS on a current channel:

1. Press & hold .
2. Scroll  to highlight CTCSS.
3. Press .
The CTCSS Tone will appear for the current channel.
4. USE  or  to select desired CTCSS tone.
5. Press  to confirm.



Channels 5 and 35 are used as emergency channels. CTCSS will not operate on these channels.

BCLO (Busy Channel Lock Out) Feature

The BCLO feature functions automatically when using a channel with CTCSS ON. If attempting to transmit on a channel with CTCSS ON and that channel is busy the BCLO feature will prevent transmission until the channel becomes clear.

UHF CB - OPERATION

KEY BEEP ON/OFF

Your radio emits a beep each time one of the keys (except for the PTT button) is pressed.

To turn Key Beep ON/OFF:

1. Press & hold **(MENU)**.
2. Scroll **(▼)** to highlight KEY BEEP.
3. Press **(ENT)**.
4. Press **(▲)** or **(▼)** to select ON or OFF.
5. Press **(ENT)** to confirm.

ROGER BEEP

Roger Beep is a BEEP that is sent to notify the end of transmission. Roger Beep can be heard through the speaker when Key Beep is on. Roger Beep is transmitted even if Key Beep is turned off. However, Roger Beep will not be heard from the speaker.

To turn Roger Beep ON/OFF:

1. Press & hold **(MENU)**.
2. Scroll **(▼)** to highlight ROGERBEEP.
3. Press **(ENT)**.
4. Press **(▲)** or **(▼)** to select ON or OFF.
5. Press **(ENT)** to confirm.

GPS OPERATION

The GPS antenna must have an unobstructed view of the sky for the GPS105 to retrieve satellite data which is used for the GPS features described on pages 13 to 25.



Current regulations permit the SEND POSITION to operate on Channels 22 and 23 only.



To comply with current regulations, Uniden recommends not to transmit data more than 10 times within an hour on channels 22 and 23.

SPEED WARNING

OPERATION FLOW



If the current speed that the GPS105 is moving at exceeds the SPEEDWARNING alert setting then a warning tone will sound and this POP UP Speed Alert will show. The current speed will be indicated. The display remains until the moving speed falls below the Alert Setting.

Press (DISP) to cancel the alert.

To set a moving speed warning limit:

1. Press & hold (MENU) to bring up the menu list.
2. Scroll (▼) to highlight SPEEDWARNING.
3. Press (ENT).
4. Press (◂) to adjust speed warning to desired level.
5. Press (ENT) to confirm.

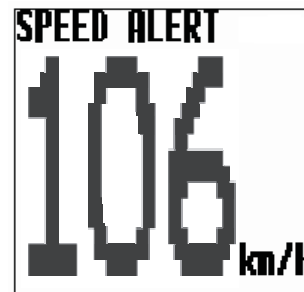

EARLY WARNING SAFETY ALERTS

The GPS105 has a preprogrammed memory that will alert you of Fixed Speed Camera, Red Light Camera or Black Spot. These displays automatically pop up and an alert tone sounds when approaching within 400m and 160m of the alert location.

Press **(DISP)** to cancel the alert.

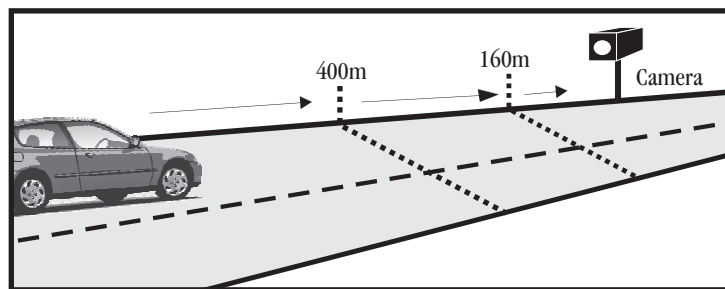
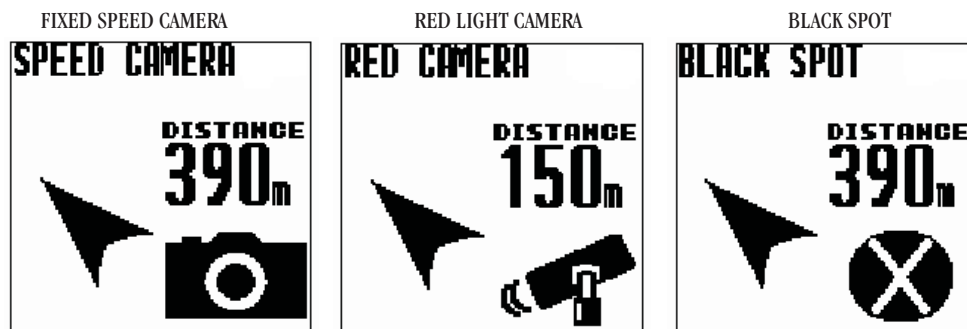

WARNING VOLUME

OPERATION FLOW



To set the volume for the safety alerts (FIXED CAMERA, RED CAMERA, BLACK SPOT & SPEED WARNING) with this function:

1. Press & hold **(MENU)** to bring up menu list.
2. Scroll **(↓)** to highlight WARNING VOL.
3. Press **(ENT)**.
4. Press **(↑)** **(↓)** to adjust volume setting (8 levels:0-7, 0 is OFF).
5. Press **(ENT)** to confirm.

CALLER DISPLAY

The caller display information received from another radio using similar technology on channels 22 and 23 will POP UP at the end of a received transmission.

The information includes :

- Callers USER NAME.
- Distance to where call was transmitted from.
- Estimated time of arrival from your location to position of caller calculated at your average moving speed.



For compass heading & distances to appear the GPS105 requires a moving direction. If '?' appears on the display please move forward to obtain direction.

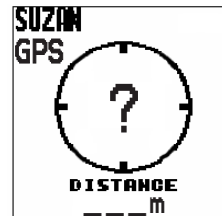

CALLER ID Memories

The GPS105 automatically stores CALLER ID data. It will store up to 20 sets of the user name, last received GPS position and the day / month are stored. Once 20 Callers are stored the oldest data is dropped from the list when new callers are added.



A caller's user name is stored in the caller list only once. If the caller calls again their information is updated, not repeated.

The POP UP CALLER will remain for 10 seconds and then return to the previous display. If you wish to keep the POP UP CALLER DISPLAY on the screen for longer then within the 10 second period press **(ENT)**. To navigate to CALLER see page 21.

To Store the Caller into MY POI

If you wish to store the caller's information as a MY POI (my point of interest to navigate back to in future) then: While the POP UP CALLER DISPLAY shows:

1. Press **(ENT)** two times within 1 second.
2. Press **(▲)** to select YES.
3. Press **(ENT)** to confirm.
To navigate to MY POI see page 22.



If you save the information from a caller already stored in MY POI then the information is updated and not repeated.

MARK LOCATION

Mark Location is used to store in memory a location, which may be used in future as a point to navigate back to, or safety alert location.

QUICK ACCESS LOCATIONS

The quick access locations are to mark your HOME, OFFICE, HOTEL, AIRPORT or BOATRAMP locations. You may mark the location with the current GPS coordinates or adjust the coordinates to suit.

OPERATION FLOW



1. Move the GPS105 to the location you wish to mark, or have the desired coordinates at hand.
2. Press and hold (MRK).



3. Scroll (▲) (▼) to highlight desired quick access name.
4. Press (ENT).
The quick access display appears with the quick access name and the current GPS coordinates:
If no GPS is available the last GPS position appears.
5. You may change the longitude & latitude values by pressing (◀) (▶) to move the cursor and pressing (▲) (▼) to change the value.
6. Press (ENT) to confirm.



- The longitude and latitude coordinates must be valid coordinates in the South Pacific Area.
- The coordinates are displayed in WGS-84 data format.

MY POI LOCATIONS

You may mark up to 500 locations into MY POI (My Point Of Interest). Each location may be personalised with a name.

OPERATION FLOW

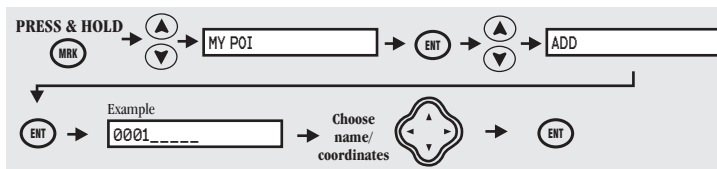

1. Move the GPS105 to the location you wish to mark as MY POI, or have the desired coordinates at hand.
2. Press and hold **MRK** to bring up the mark location list.
3. Scroll **▲** **▼** to highlight MY POI.
4. Press **ENT**.
5. Scroll **▲** **▼** to highlight ADD.
6. Press **ENT**.
7. MY POI display appears with the next available memory number and the current coordinates.
You can move the cursor by pressing **◀** or **▶** and can adjust the name and coordinate readings by pressing **▲** or **▼**.

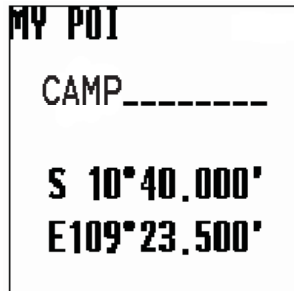

8. When satisfied with the name and coordinates press **ENT** to confirm.



- If the name already exists or the coordinates are invalid an error message will appear.
- The longitude and latitude coordinates must be valid coordinates in the South Pacific Area.
- Coordinates are displayed in WGS84 data format.

EDIT/DELETE MY POI

OPERATION FLOW

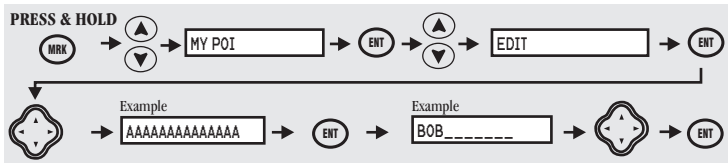

1. Press and hold **MARK** to bring up Mark Location List.
2. Scroll **▲ ▼** to highlight MY POI.
3. Press **ENT**.
4. Scroll **▲ ▼** to highlight EDIT or DELETE.
5. Press **ENT**.
6. The EDIT or DELETE MY POI name list appears in Alpha-numeric order.
To find a name you may scroll **▲ ▼**. To shortcut to the capital letter of the name press **▶** to highlight the capital letter on the right of the display. Then scroll **▲ ▼** to the desired letter. Press **◀** to move back to the name list.



7. Press **ENT** to confirm name selection.
8. If you have chosen EDIT you may use the **⬇** buttons to edit the name and the coordinates.
If you have chosen DELETE the delete confirmation display appears. Press **▲ ▼** to select delete YES or NO.
9. When satisfied with the edit or ready to delete, press **ENT** to confirm.



If a key is not pressed within 60 seconds Edit/Delete MY POI is cancelled.

ADD or DELETE SAFETY ALERT

You can store into memory new safety alert (Fixed Speed Camera, Red Light Camera or Black Spot) locations. If the GPS105 is within 400m of a stored Safety Alert or OPTION location then you can delete this from memory.



The OPTION feature is currently unavailable but may in future be pre-programmed with points of interest.

OPERATION FLOW

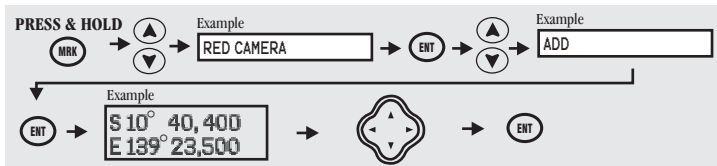

1. Move the GPS105 to an alert location you wish to add or delete.
2. Press and hold **MRK** to bring up Mark Location List.
3. Scroll **▲** **▼** to highlight SPEED CAMERA or RED CAMERA or BLACK SPOT or OPTION.
4. Press **ENT**.
5. Scroll **▲** **▼** to highlight ADD or DELETE.
6. Press **ENT**.
7. When ADD is selected your current GPS location is displayed. You may edit the coordinates using the scroll buttons.



When DELETE is selected press **▲** or **▼** to select delete YES or NO.

8. When ready, press **ENT** to confirm.



If a key is not pressed within 60 seconds Add or Delete Safety Alert is cancelled.

NAVIGATION

The navigation feature allows you to select a desired stored location point to navigate to. The location point can be a pre-installed state, city or suburb, quick access location, MY POI or CALLER from the caller list.

When navigating to a location point the navigation or NAVI Display alternates as follows:

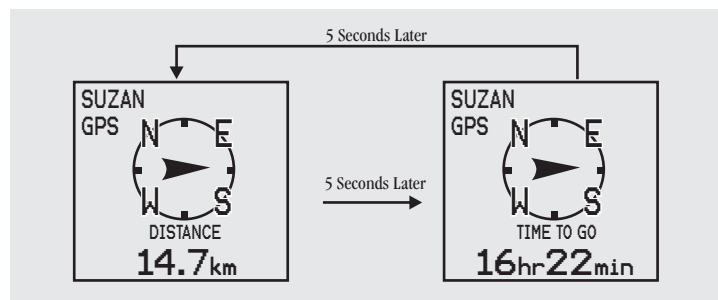

If PTT is pressed the UHF-CB Display will appear. When transmission is complete the display will return to NAVI Display after 5 secs.

When approaching within 160m and 20m of the set destination the NAVI ARRIVE Tone will sound.



*The compass heading (directional pointer) is referenced to the GPS105's last forward movement.
When viewing the compass heading the GPS105 must be facing in the direction of the last forward movement in order to read the compass heading correctly.*

Navigate to Quick Access

OPERATION FLOW



1. Press .
2. Scroll to highlight desired Quick Access Name.
3. Press . NAVI display appears.

Press to switch between UHF-CB, NAVI & TRIP COMPUTER displays.

To Cancel Navigation press then press .



Navigate to CALLER

OPERATION FLOW



1. Press .
2. Scroll to highlight CALLER.
3. Press .
4. Scroll to desired caller.
5. Press . NAVI display appears.

Press to switch between UHF-CB, NAVI & TRIP COMPUTER displays.

To Cancel Navigation press then press .



Navigate to MY POI

OPERATION FLOW



1. Press **(NAVI)**.
2. Scroll **(▲)** **(▼)** to highlight MY POI.
3. Press **(ENT)**.
4. Scroll **(▲)** **(▼)** to find a desired name.



To shortcut to the capital letter of the name:

Press **(▶)** to highlight the capital letter on the right of the display.

Scroll **(▲)** **(▼)** to the desired letter.

Press **(◀)** to move back to the name list.

5. Press **(ENT)**. NAVI display appears.

Press **(DISP)** to switch between UHF-CB, NAVI & TRIP COMPUTER displays.

To Cancel Navigation press **(NAVI)** then press **(ENT)**.

Navigate to STATE/CITY

OPERATION FLOW

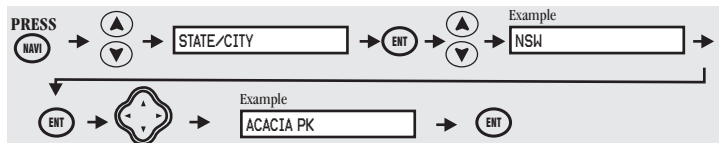

1. Press **NAVI**.
2. Scroll **▲ ▼** to highlight STATE/CITY.
3. Press **ENT**.
The list of Australian States and NZ appears.

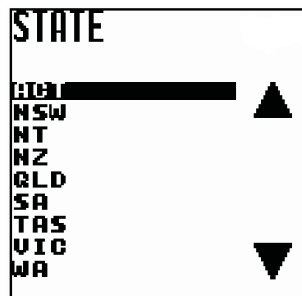

4. Scroll **▲ ▼** to desired state.
5. Press **ENT**. The City/Suburb list appears.
6. Scroll **▲ ▼** to desired City or suburb.
To shortcut to the capital letter of the name:
Press **▶** to highlight the capital letter on the right of the display.
Scroll **▲ ▼** to the desired letter.
Press **◀** to move back to the name list.
7. Press **ENT**. NAVI display appears.

Press **DISP** to switch between UHF-CB, NAVI & TRIP COMPUTER displays.

To Cancel Navigation press **NAVI** then press **ENT**.

TRIP COMPUTER

The GPS105 can indicate COMPASS heading and the present speed, average speed, maximum speed and the distance travelled through the TRIP COMPUTER.

Press **(DISP)** to switch between UHF-CB, NAVI (if navigating) & TRIP COMPUTER displays.

The TRIP displays alternate automatically as follows:

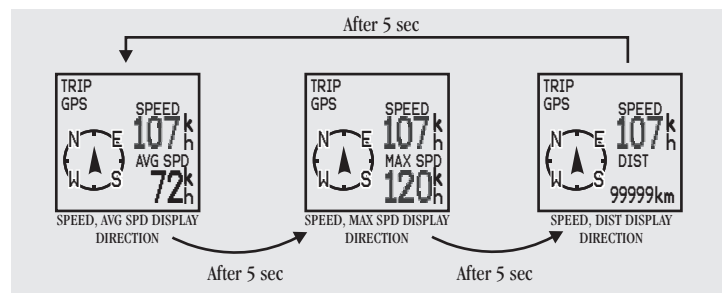

TO RESET TRIP COMPUTER

OPERATION FLOW

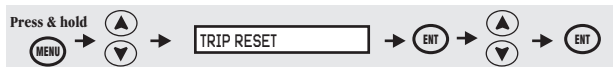

1. Press & hold **(MENU)** to bring up menu list.
2. Scroll **(UP)** / **(DOWN)** to highlight TRIP RESET.
3. Press **(ENT)**.
4. Press **(UP)** or **(DOWN)** to select YES.
5. Press **(ENT)** to confirm.

MY POSITION

OPERATION FLOW



Your current GPS coordinates can be viewed with this selection.

1. Press & hold **MENU** to bring up the menu list.
MY POSITION appears as the first highlighted selection.
2. Press **ENT** to confirm selection.
My Position display appears with your current GPS coordinates.
3. Press **ENT** or **DISP** to exit.

MY POSITION
S 10°32.095'
E136°90.080'
ALTITUDE
100m



coordinates are displayed in WGS84 format.

LCD CONTRAST

OPERATION FLOW



1. Press & hold **MENU** to bring up the menu list.
2. Scroll **↑** **↓** to highlight LCD CONTRAST.
3. Press **ENT**.
4. Press **↑** **↓** to adjust contrast level (8 levels 0-7).
5. Press **ENT** to confirm.

UHF CHANNELS & FREQUENCIES

CH No.	Simplex Mode Transmit / Receive Frequency (MHz)	Duplex Mode Transmit Frequency (MHz)	CH No.	Simplex Mode Transmit / Receive Frequency (MHz)
1	476.425	477.175 CH31	21	476.925
2	476.450	477.200 CH32	22	476.950
3	476.475	477.225 CH33	23	476.975
4	476.500	477.250 CH34	24	477.000
5	476.525	477.275 CH35	25	477.025
6	476.550	477.300 CH36	26	477.050
7	476.575	477.325 CH37	27	477.075
8	476.600	477.350 CH38	28	477.100
9	476.625		29	477.125
10	476.650		30	477.150
11	476.675		31	477.175
12	476.700		32	477.200
13	476.725		33	477.225
14	476.750		34	477.250
15	476.775		35	477.275
16	476.800		36	477.300
17	476.825		37	477.325
18	476.850		38	477.350
19	476.875		39	477.375
20	476.900		40	477.400



Channels 05 and 35 are Emergency Channels and Channel 11 is a Calling Channel. Channels 22 and 23 are used for telemetry and telecommand applications, voice communications are not permitted on these channels.

CTCSS TONE LIST

Code No.	Freq. (Hz)	Code No.	Freq. (Hz)	Code No.	Freq. (Hz)
00 ("OFF")	OFF	13	103.5	26	162.2
01	67.0	14	107.2	27	167.9
02	71.9	15	110.9	28	173.8
03	74.4	16	114.8	29	179.9
04	77.0	17	118.8	30	186.2
05	79.7	18	123.0	31	192.8
06	82.5	19	127.3	32	203.5
07	85.4	20	131.8	33	210.7
08	88.5	21	136.5	34	218.1
09	91.5	22	141.3	35	225.7
10	94.8	23	146.2	36	233.6
11	97.4	24	151.4	37	241.8
12	100.0	25	156.7	38	250.3

TROUBLESHOOTING

If your GPS105 does not perform to your expectations, try the suggestions listed below.

Unit does not operate.	<ul style="list-style-type: none">● Check the 2 Amp fuse in the power lead.
No GPS Detection.	<ul style="list-style-type: none">● Make sure the GPS antenna has an unobstructed view of the sky.
Cannot send or receive Caller ID.	<ul style="list-style-type: none">● Make sure you are communicating with a compatible unit on channels 22 or 23.● Check that SEND POSITION is set to ON (Quick Start Guide step 5).
Does not operate in Duplex mode.	<ul style="list-style-type: none">● Make sure you select channels 1-8 for Duplex operation.● Check that you are within range of a local repeater station.

WARRANTY

UNIDEN GPS105 UHF CB RADIO WITH GPS

Limited One Year Warranty



Please keep your sales docket as it provides evidence of warranty.

Warrantor: Uniden Australia Pty Limited ABN 58 001 865 498
Uniden New Zealand Limited

Warranty only available in original country of purchase

Elements of Warranty: Uniden warrants to the original retail owner for the duration of this warranty, its GPS105 UHF CB Transceiver Radio with GPS (hereinafter referred to as the Product) to be free from defects in materials and craftsmanship with only the limitations or exclusions set out below.

Warranty Duration: This warranty to the original retail owner only, shall terminate and be of no further effect ONE (1) Year after the date of original retail sale. This warranty will be deemed invalid if the Product is; (A) Damaged or not maintained as reasonable and necessary, (B) Modified, altered or used as part of any conversion kits, subassemblies, or any configurations not sold by Uniden, (C) Improperly installed, (D) Repaired by someone other than an authorised Uniden Repair Agent for a defect or malfunction covered by this warranty, (E) Used in conjunction with any equipment or parts or as part of a system not manufactured by Uniden, (F) Installed, programmed or serviced by anyone other than an authorised Uniden Repair Agent, or (G) Where the Serial Number label of the product has been removed or damaged beyond recognition.

Parts Covered: This warranty covers for 1 year, the UHF CB Transceiver. Accessories: Internal GPS Antenna, microphone etc is covered for 90 days.

Statement of Remedy: In the event that the product does not conform to this warranty at any time while this warranty is in effect, the warrantor at its discretion, will repair the defect or replace the product and return it to you without charge for parts and service. This warranty does not cover provide for the reimbursement or payment of incidental or consequential damages.

THIS GUARANTEE IS IN ADDITION TO AND DOES NOT IN ANY WAY AFFECT YOUR RIGHTS UNDER THE CONSUMER GUARANTEE ACT.

Procedure for Obtaining Performance or Warranty: In the event that the Product does not conform to this warranty, the Product should be shipped or delivered, freight prepaid, with evidence of original purchase, (eg. a copy of the sales docket), to the warrantor at:

UNIDEN AUSTRALIA PTY LIMITED Service Division 345 Princes Highway, Rockdale, NSW 2216 Fax (02) 9599 3278 www.uniden.com.au	UNIDEN NEW ZEALAND LIMITED Service Division 150 Harris Road, East Tamaki, Auckland Fax (09) 274 4253 www.uniden.co.nz
--	---

Customers in other states should ship or deliver the Product freight pre-paid to the nearest Uniden Authorised Repair Centre. (Contact Uniden for the Warranty Agent nearest you.)

THANK YOU

FOR PURCHASING A UNIDEN PRODUCT

Uniden

© 2004
Uniden Australia Pty Limited
Uniden New Zealand Limited
Printed in China
UTZZ01926ZZ