



PROFESSIONAL DIRECT DRIVE TURNTABLE

**PDX-d3S**

**OWNER'S MANUAL**

VESTAX CORPORATION  
2-37-1 Kamiima, Setagaya-ku, Tokyo 154-0011 Japan  
Phone:03-3412-7011 Fax:03-3412-7013

VESTAX America  
2750C 29th Ave Suite 115 Hollywood, FL 33020  
Phone:303-766-5269 Fax:303-766-2196  
E-mail:vestaxcorporation@msn.com

VESTAX (Europe)Ltd.  
18st Christophers Road, Haslemere, Surrey GU 27 1DQ England.  
Phone:(0)1428-653117 Fax:(0)1428-661021

---

# CONGRATULATION

Thank you for purchasing the Vestax PDX-d3S, Professional Direct Drive Turntable.

Please read this owner's manual carefully before you start to use yours, so that you will fully understand all of the special features and enjoy the full use of the product.

| <b>CONTENTS</b>                                |    |
|--|----|
| FEATURES                                       | 3  |
| NOTES  | 3  |
| A. S. T. S.<br>(ANTI SKIPPING TONE-ARM SYSTEM) | 4  |
| EACH PARTS NAME                                | 5  |
| BEFORE USE                                     | 5  |
| ASSEMBLY AND SET-UP                            | 6  |
| INSTALLATION AND CONNECTION                    | 7  |
| ADJUSTMENT                                     | 8  |
| OPERATION                                      | 9  |
| DIGITAL CONTROL                                | 10 |
| REMOTE CONTROL                                 | 11 |
| SPECIFICATION                                  | 11 |

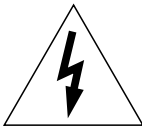

## CAUTION

RISK OF ELECTRIC SHOCK DO NOT OPEN



**CAUTION : TO REDUCE THE RISK OF ELECTRIC SHOCK  
DO NOT REMOVE COVER (OR BACK)  
NO USER-SERVICEABLE PARTS INSIDE  
REFER SERVICING TO QUALIFIED SERVICE PERSONNEL**

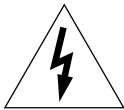

The lightning flash with arrowhead symbol, within an equilateral triangle, is intended to alert the user to the presence of uninsulated "dangerous voltage" within the product's enclosure that may be of sufficient magnitude to constitute a risk of electric shock to persons.



The exclamation point within an equilateral triangle is intended to alert the user to the presence of important operating and maintenance (servicing) instructions in the literature accompanying the appliance.

TO REDUCE THE RISK OF FIRE OR ELECTRIC SHOCK, DO NOT EXPOSE THIS APPLIANCE TO RAIN OR MOISTURE.

**CAUTION :** TO PREVENT ELECTRIC SHOCK, MATCH BLADE OF PLUG TO WIDE SLOT, FULLY INSERT

**ATTENTION :** POUR EVITER LES CHOCS ELECTRIQUES, INTRODUIRE LA LAME LA PLUS LARGE DE LA FICHE DANS LA BORNE CORRESPONDANTE DE LA PRISE ET POUSSER JUSQU' AU FOND

# IMPORTANT SAFEGUARDS

## READ BEFORE OPERATING EQUIPMENT

This product was designed and manufactured to meet strict quality and safety standards. There are, however, some installation and operation precautions which you should be particularly aware of.

1. Read instructions-All the safety and operating instructions should be read before the appliance is operated.
2. Retain instructions-The safety and operating instructions should be retained for future reference.
3. Heed Warnings-All warnings on the appliance and in the operating instructions should be adhered to.
4. Follow Instructions-All operating and use instructions should be followed.
5. Cleaning-Unplug this product from the wall outlet before cleaning. Do not use liquid cleaners or aerosol cleaners. Use a damp cloth for cleaning.
6. Attachments-Do not use attachments not recommended by the product manufacturer as they may cause hazards.
7. Water and Moisture-Do not use this product near water-for example, near a bath tub, wash bowl, kitchen sink, or laundry tub, in a wet basement, or near a swimming pool, and the like.
8. Accessories-Do not place this product on an unstable cart, stand, tripod, or table. The product may fall, causing serious injury to a child or adult, and serious damage to the appliance. Use only with a cart, stand, tripod, bracket, or table recommended by the manufacturer, or sold with product. Any mounting of the appliance should follow the manufacturer's instructions, and should use a mounting accessory recommended by the manufacturer.
9. Ventilation-Slots and openings in the cabinet are provided for ventilation and to ensure reliable operation of the product and to protect it from overheating, and these openings must not be blocked or covered. The openings should never be blocked by placing the product on a bed, sofa, rug, or other similar surface. This product should never be placed near or over a radiator or heat register. This product should not be placed in a built-in installation such as a bookcase or rack unless proper ventilation is provided or the manufacturer's instructions have been adhered to.
10. Power sources-This product should be operated only from the type of power source indicated on the marking label. If you are not sure of the type of power supply to your home, consult your appliance dealer or local power company.
11. Grounding or Polarization-This product is equipped with a polarized alternating-current line plug (a plug having one blade wider than the other). This plug will fit into the power outlet only one way. This is safety feature. If you are unable to insert the plug fully into the outlet, try reversing the plug. If this should still fail to fit, contact your electrician to replace your obsolete outlet. Do not defeat the safety purpose of the polarized plug.
12. Power-Cord Protection-Power supply cords should be routed so that they are not likely to be walked on or pinched by items placed upon or against them, paying particular attention to cords at plugs, convenience receptacles, and the point where they exit from the appliance.
13. Protective Attachment Plug-The appliance is equipped with an attachment plug having overload protection. This is a safety feature. See Instruction Manual for replacement or resetting of protective device. If replacement of the plug is required, be sure the service technician has used a replacement plug specified by the manufacturer that has the same overload protection as the original plug.
14. Lightning-For added protection for this product during lightning storm, or when it is left unattended and unused for long periods of time, unplug it from the wall outlet. This will prevent damage to the product due to lightning and power-line surges.
15. Overloading-Do not overload wall outlets and extension cords as this can result in a risk of fire or electric shock.
16. Object and Liquid Entry-Never push objects of any kind into this product through openings as they may touch dangerous voltage points or short-out parts that could result in a fire or electric shock. Never spill liquid of any kind on the product.
17. Servicing-Do not attempt to service product yourself as opening or removing covers may expose you to dangerous voltage or other hazards. Refer all servicing to qualified personnel.
18. Damage Requiring Service-Unplug this product from the wall outlet and refer servicing to qualified service personnel under the following conditions:
  - a. When the power-supply cord or plug is damaged.
  - b. If liquid has been spilled or objects have fallen into the product.
  - c. If the product has been exposed to rain or water.
  - d. If the product does not operate normally by following the operating instructions. Adjust only those controls that are covered by the operating instructions as an improper adjustment of other controls may result in damage and will often require extensive work by a qualified technician to restore the product to its normal operation.
  - e. If the product has been dropped or cabinet has been damaged.
  - f. When the product exhibits a distinct change in performance-this indicates need for service.

19. Replacement Parts-When replacement parts are required, be sure the service technician has used replacement parts specified by the manufacturer or have the same characteristics as the original parts. Unauthorized substitutions may result in fire, electric shock or other hazards.
20. Safety Check-Upon completion of any service or repairs to product, ask the service technician to perform safety checks to determine that the product is in proper operating condition.

21. Carts and Stands-The appliance should be used only with a cart stand that is recommended by manufacturer.
22. An appliance and cart combination should be moved with care. Quick stops, excessive force, and uneven surfaces may cause the appliance and cart combination to overturn.



## FEATURES

- The PDX-d3S is a high end performance turntable designed for the beginners and the professionals with the same basic quality as the best selling turntable, the PDT-5000.
- ANTI SKIPPING TONE-ARM SYSTEM, TRACING HOLD BALANCE SYSTEM  
New designed A.S.T.S(Anti Skipping Tone-arm System) and TH(Tracing Hold) balance TONE-ARM system protect skipping performance in hard scratching. And this TONE-ARM provide adjustment mechanism of tone-arm height which Vestax Turntable series have generally.
- FAST STARTS BY HIGH TORQUE  
Using high-torque direct motor, the integral motor delivers 1.6kg•cm start torque. The high-torque gives quick starts that enables the platter to reach 33-1/3 rpm within 0.3 second.
- FLOATING SUSPENSION TONEARM  
The tone-arm is mounted on the deck plate using a floating suspension system with the drive motor. Acoustic feedback is minimized by this advanced system.
- QUARTZ-PHASE-LOCKED CONTROL  
The pitch is variable continuously by up to approximately  $\pm 10\%$  and returned automatically to the predetermined speed (33-1/3 or 45 rpm) by on/off switch even if the pitch control is employed.
- NON-CENTER-CLICK PITCH FADER  
Pitch fader has no center click, and it allows delicate adjustment easily. The PDX-d3S features detachable pitch control fader for ease of replacement when it is worn out.
- MINI LIGHT FOR ILLUMINATING STYLUS  
The PDX-d3S provides detachable small stylus illuminator for illuminating the stylus tip during play for low-light conditions.
- OTHER FEATURES  
Quick stops are achieved with an electronic braking system. Remote control jack is provided for controlling START/STOP by other equipment like a fader start etc.
- Using FULL TIME QUARTS LOCK SYNTHESIZER.  
rotation of turntable is controlled. Using PLL circuit of the two system. Accuracy of playing speed and time keeping will be completed.
- The pitch speed is controlled by none center click pitch control fader volume. The pitch fader span can be selected between  $\pm 12\%$ ,  $\pm 6\%$ ,  $\pm 3\%$ .
- MOTOR OFF function is provided to cancel servo/brake of the motor and REVERSE MODE will reverse the turntable thus provided.
- STICK CONTROLLER is provided for the functions of pitch bend and FAST/SLOW, so that it is possible to adjust speed up or down to begin phrase of a song without touching the record.

## NOTES

- Before detaching or attaching the headshell, be sure to turn the power of the amplifier or mixer off.
- Detaching or attaching of the headshell with the volume control turned up may cause damage to the speakers.
- Do not turn "ON" the power supply, with the turntable platter detached.
- When play is finished, be sure to secure the tone-arm with the arm clamp. After play is finished, if the unit is not to be used for some time, care should be taken to secure the tone-arm to protect the stylus tip. For the same reason, the stylus protector should also be attached.
- Wipe the headshell terminals from time to time. Dust and dirt at the headshell terminals may result in increased "HUM" noise or intermittent sound. Use a soft dry cloth to clean the headshell terminals.
- Dust and dirt should be carefully removed from stylus tip or records. Dust and dirt on the stylus tip or record may not only result in deterioration of tone quality, but also cause undue wear of the record and the stylus tip itself.
- Transportation of the unit to distant places for removal and the like. Pack up the unit in the reverse order to that for unpacking, using the packing materials furnished when the unit was purchased. Should there be no such packing materials, be sure to take the following steps. Remove the turntable platter together with the turntable mat, and wrap it up to prevent any damage to them. Return the tone-arm to the arm rest, and affix it with tape or the like. Remove the balance weight and the headshell/cartridge from the tone-arm and then wrap them up to avoid and damage to them. Wrap up the turntable base with a blanket or soft paper also to prevent any possible damage to it.
- ACOUSTIC FEEDBACK AND HUM  
Acoustic Feedback is usually caused by vibration of speaker, which affects the sensitive cartridge. If such a phenomenon occurs, relocate the turntable or speakers as far apart from each other as possible. Hum is usually caused by nearby appliances that use transformer or thermostat. Relocating the unit further away from the noise sources will readily solve the problem. Hum may also be produced if the grounding wire extending from the unit is securely connected to the GND terminal on the amplifier or mixer.

# A.S.T.S(Anti Skipping Tone-arm System)

A.S.T.S(Anti Skipping Tone-arm System) has been developed with years of experience and a number of trials, searching for the innovative tone-arm for professional DJ's. This system breaks all of the historic common sense, achieving its non skipping performance in hard scratching. A.S.T.S consists of two inventions, short/straight arm and TH (Tracing Hold) balance system.

- TH balance system gives horizontal movement in addition to vertical. This movement gives much more stable balance (vertical direction) to the needle. The combination of short / straight arm and TH balance system gives the best stability to the needle, which enables anti-skipping in hard scratching.
- The brass arm with aluminum cover is used for A.S.T.S . This combination results in the best pick up sensitivity as well as the best resistance to howling. This new tone-arm allowed A.S.T.S to increase the resistance against the howling by over 50% compared to the normal aluminum arm.

## NORMAL TYPE TONE-ARM

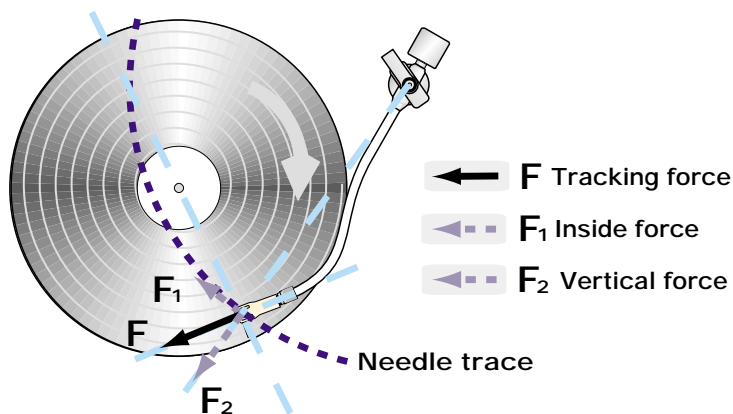

**F** (Tracking force) generates inside force.

## A. S. T. S

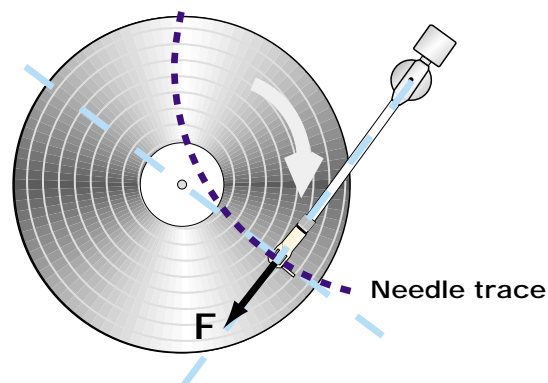

No inside force is generated.

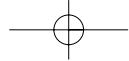

# EACH PARTS NAME

## FRONT

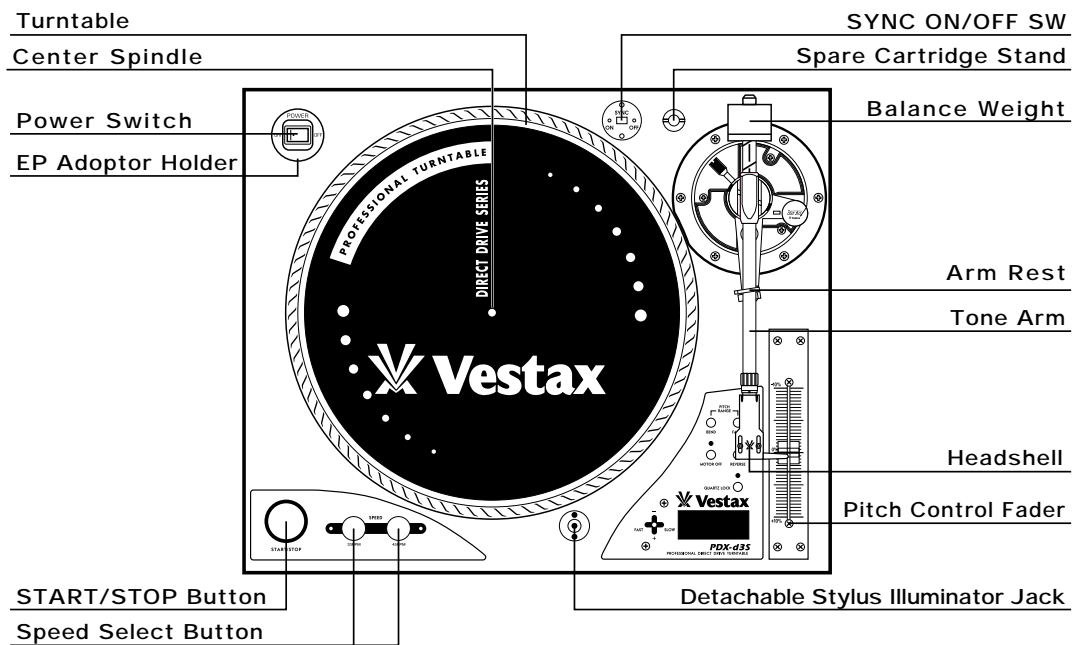

## REAR

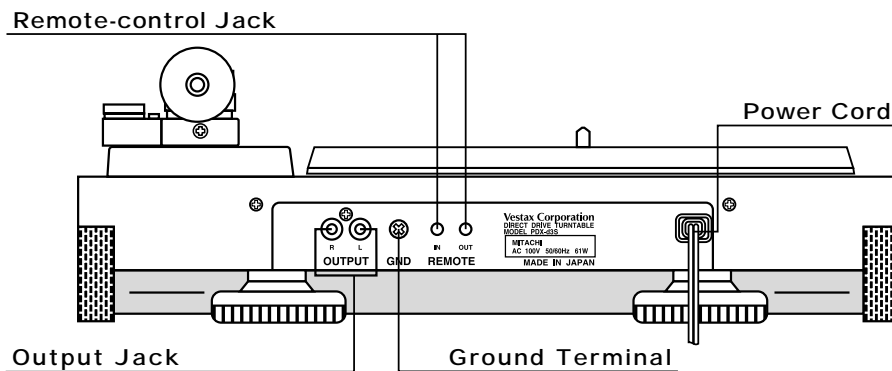

# BEFORE USE

## CHECKLIST OF PARTS

This unit includes the following parts

- ① Turntable Unit
- ② Turntable Platter
- ③ Slip Mat
- ④ Shell Weight
- ⑤ Headshell
- ⑥ Balance Weight
- ⑦ RCA Cable
- ⑧ GND Cable
- ⑨ EP Adaptor

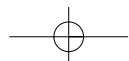

# ASSEMBLY AND SET-UP

## Installation of Turntable Platter

- ① By placing the turntable platter on the center spindle, the platter adjusts to match the spindle by itself.
- ② Place the slip mat on the platter.
- ③ Extra care should be taken to avoid damaging magnet by dropping it.

### NOTE

Never connect the AC power plug before assembly has been completed.

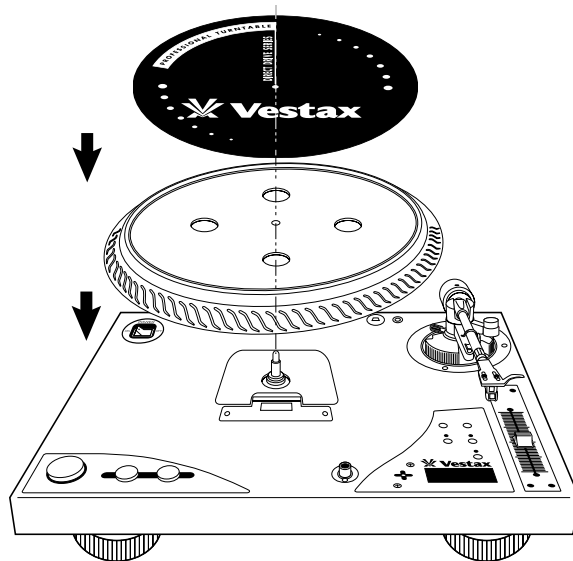

## Installation of Balance Weight

- ① Place the balance weight on the rear shaft of the tone-arm winding the balance weight clockwise.

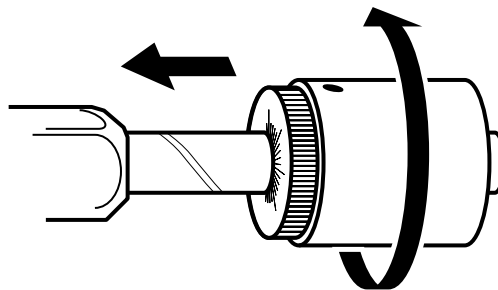

## Method of Using Slip Mat

- ① Place slip mat on the turntable platter, and place the record on the slip mat. It is possible to stop and return the record by hand while the turntable revolving.



Surface of slip mat (printed): Disk side  
Inside of slip mat : Slip side

## Installation of Cartridge

- ① In accordance with the instructions of the cartridge, install a cartridge properly.
- ② Connect the lead wires to the cartridge terminals. The terminals of most cartridges are color corded. Connect each lead wire to the terminal of the same color.

Red (R+) → Right Channel+    Green (R-) → Right Channel -  
White (L-) → Left Channel+    Blue (L-) → Left Channel -

### NOTE

In case the cartridge weight is less than 8g, it is necessary to fix the attached shell weight on the cartridge.

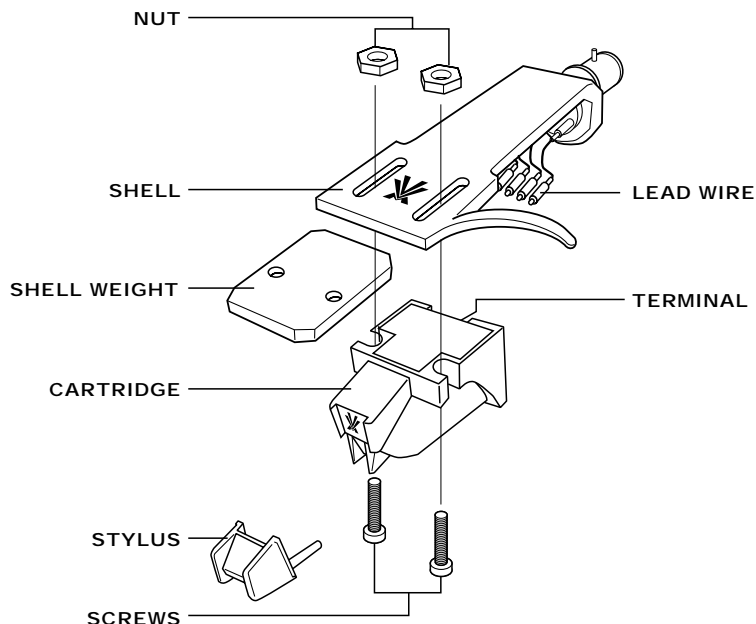

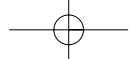

③ Insert the headshell into the front part of the tone-arm. Turn the LOCK RING to the direction of the arrow shown in the figure until fixing the headshell.

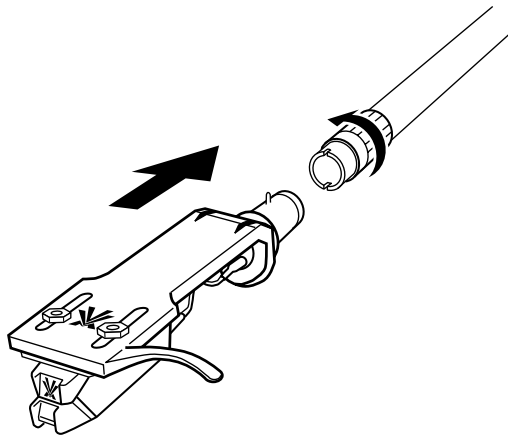

④ Adjustment of Overhang

As shown in the illustration, overhang indicates the distance from the stylus to end of headshell. Please set the distance to 50mm. If the overhang adjustment is not properly made, the stylus will not be able to trace the record grooves correctly.

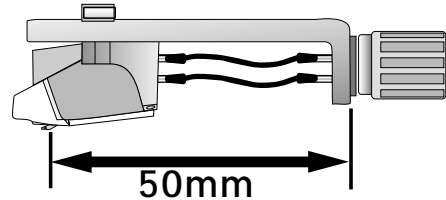

NOTE

Be sure not to touch stylus during adjustment with finger.

## INSTALLATION AND CONNECTION

### CONNECTION OF PHONO TERMINAL AND PLUG

① Connect the output to inputs of amplifier or mixer.

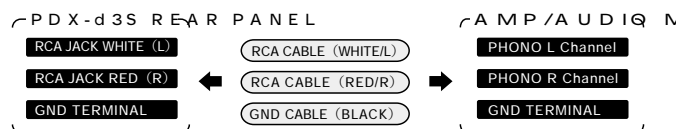

NOTE

Be sure to connect firmly the GND terminal to the amplifier or mixer, or a power source HUM will result.

### INSTALLATION

- Do not place the unit where it is exposed to direct sun light, high temperature or humidity to prevent possible troubles.
- Place the unit in a stable and horizontal position, where there is little or no vibration.
- Locate the unit as far away from the speakers as possible and isolate the unit from sound radiation from them.
- If the unit is placed too close to the radio, interference to AM/FM reception may result.

### ILLUSTRATION OF CONNECTION

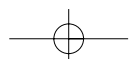
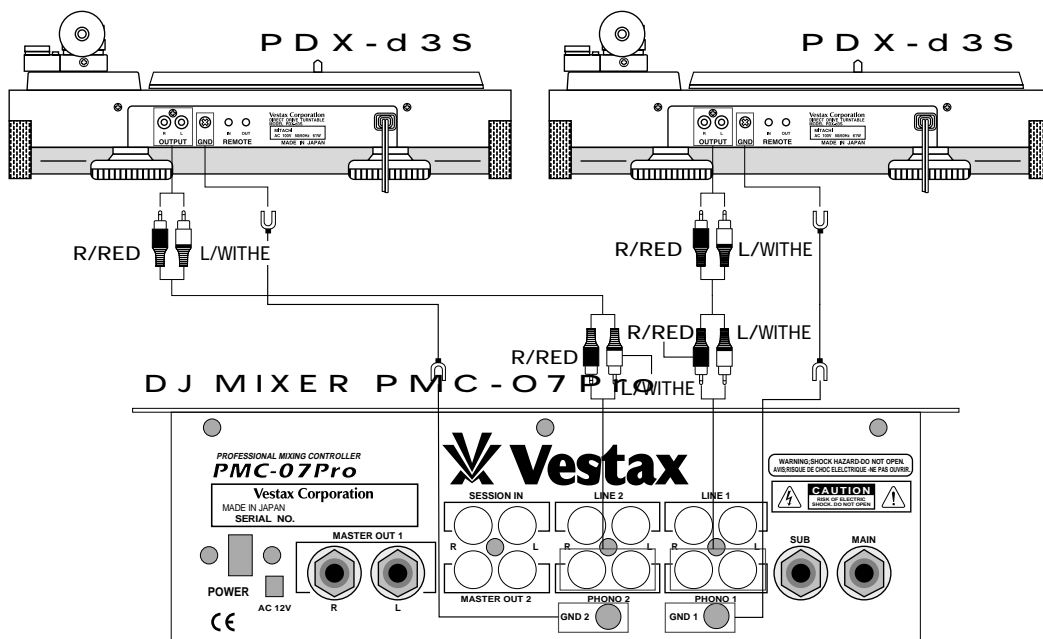



# ADJUSTMENT

## Adjustment of Horizontal Zero

- ① Release the tone-arm from the armrest to free.
- ② Turn the balance weight clockwise or counter clockwise until the tone arm is balanced horizontally.

### NOTE

Be careful not to touch your finger to the stylus tip.

- ③ Return the tone-arm to the armrest.

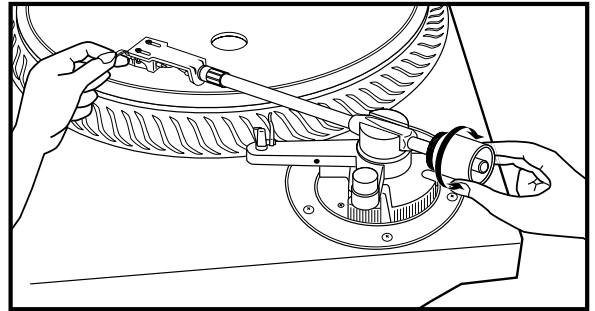

### Illustration of Adjustment

- The balance weight and cartridge are balanced, the tone-arm is held horizontal.
- × Excessive forward advancement of the balance weight causes the cartridge side to be lowered.
- × Excessive backward re-treatment of the balance weight causes the cartridge side to be raised.

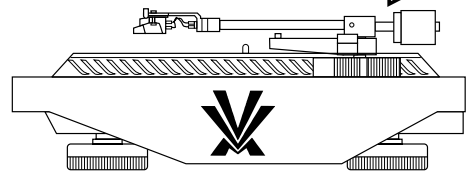

## Adjustment of Stylus Pressure

- ① Hold the balance weight with one hand as shown in the drawing, and rotate only counter ring to bring the numeral "0" of the ring into alignment with the center line on the tone-arm rear shaft.

### NOTE

In case the balance weight moved, do the adjustment of horizontal zero balance again.

- ② Turn the balance weight to present the reading on the gauge to the designed stylus force of your cartridge. As the counter ring moves in step with the balance weight, proper stylus pressure can be selected by reading the graduated ring directly.

### NOTE

The appropriate stylus pressure (generally 3~4g) needs to be set in order to generate the best performance. Please refer to the user's manual of the stylus.

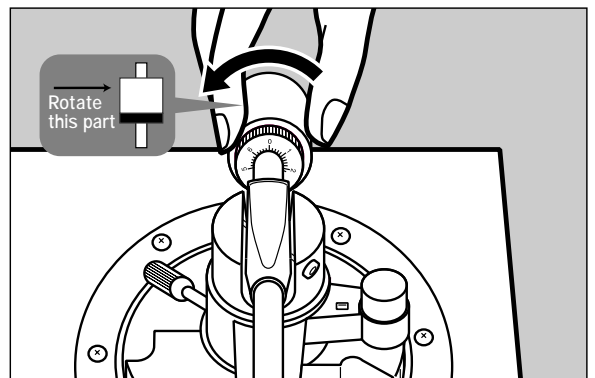
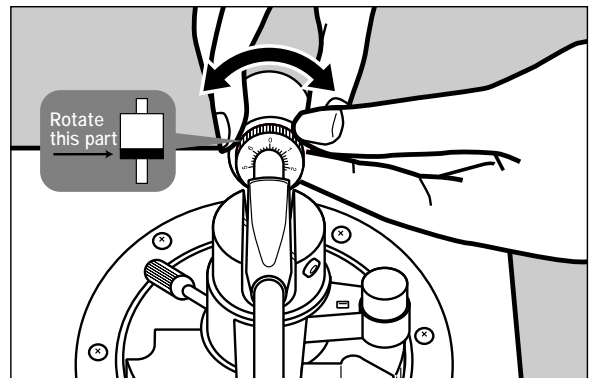

## Adjustment of Tone-arm Height

- ① The height of the tone-arm can be adjusted maximum 9mm by adjust ring.

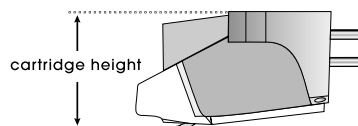

In case of 16mm cartridge height → Adjustment of tone-arm height do not need.  
 In case of 25mm cartridge height → Adjustment of tone-arm height need to set 9mm(MAX).

### NOTE

Generally, the highest setting of the tone-arm provides the best performance with minimum skipping. However, the original setting can be made according to user's experiences. Please tighten the adjustment screw after setting the height.

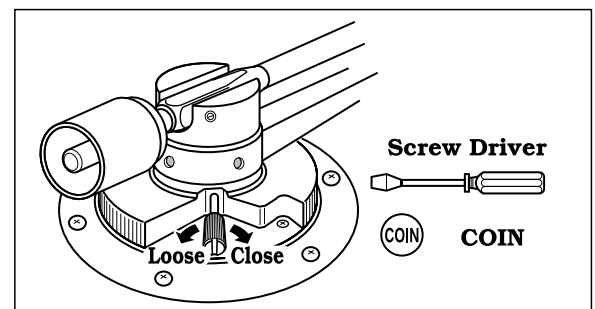

# OPERATION

- ① Place the record on the turntable mat.
- ② Press the power switch button provided at rear panel to turn "ON" position.
- ③ Remove the stylus protector if cartridge is detachable one.
- ④ Push the start/stop button, then platter will start to turn.
- ⑤ Move the tone-arm position over the record. Put it down to the record, and play will begin.
- ⑥ Set the turning speed to 33 1/3rpm or 45rpm by pushing the speed select switch in obedience to the playing record RPM.

## NOTE

A manual method of operation has been chosen for the playing of records instead of using "Cue Levers". The unit has been set to select 33-1/3 rpm automatically when the power button is pressed to on. Push the 45 rpm speed select button if you play 45 rpm record.

- ⑦ Move the tone-arm to the armrest when play is finished.
- ⑧ Push the start/stop button, and platter will stop.
- ⑨ Turn off the power.

## IN CASE OF PLAYING EP SIZE RECORD

Fit the EP ADOPTOR in the center spindle, and start to play after fitting EP RECORDS in EP ADOPTOR.

## STYLUS ILLUMINATOR (Detachable Mini Light)

This unit features a small light for illuminating the stylus. It is detachable and you can remove it when not in use.

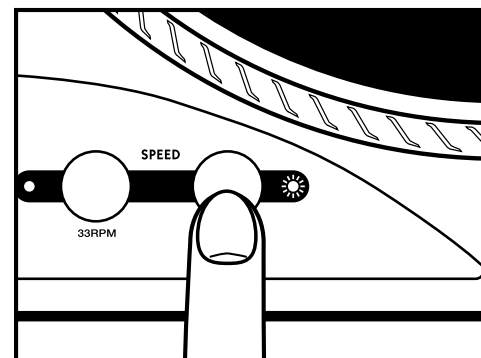
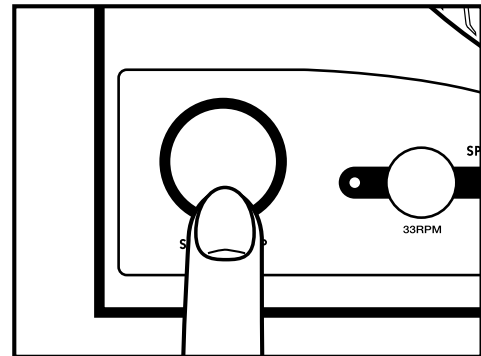
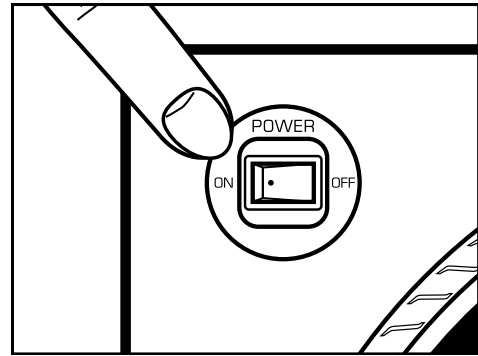

☀ Lighting : 45rpm

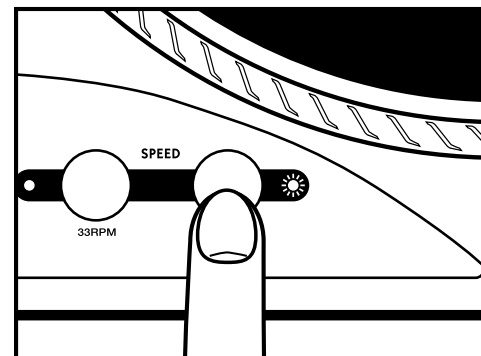

☀ Lighting : 45rpm

# DIGITAL CONTROL

## ① FADER PITCH SPAN SELECT SWITCH

Pushing the switch, fader pitch span can be selected between  $\pm 3\%$ ,  $\pm 6\%$ ,  $\pm 12\%$ . while watching the display ⑦, push this switch continuously until the indicated value of span to select and stop pushing. (refer to fig.1)

fig1. FADER PITCH SPAN SELECT SWITCH



### NOTE

When the display return to pitch meter selected value of span is set. but the value of span has error  $\pm 0.9\%$  because of limit of electric function. The display indicate the value of pitch exactly. So that value will be indicated of the display than the position of PITCH FADER VOLUME.

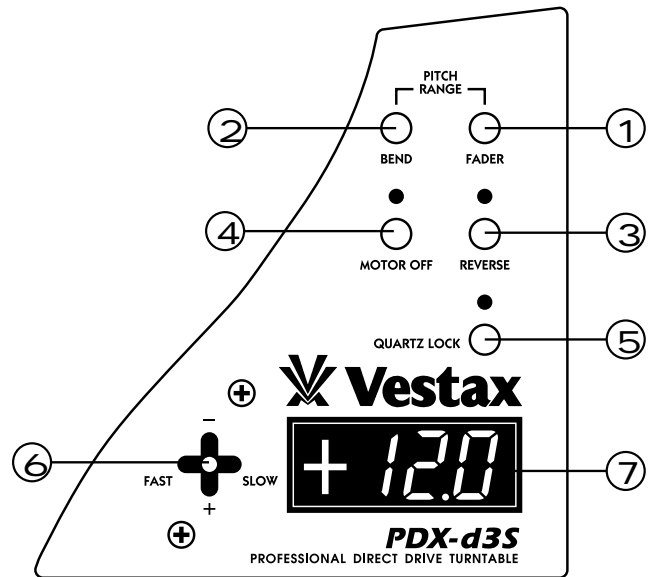

## ② PITCH BEND RANGE SELECT

Moving the stick controller down, the pitch speed is set in minus direction. Moving the stick controller up, the pitch speed is set in plus direction. The pitch bend span is set by PITCH BEND RANGE SELECT SWITCH, left glimmering number ranks with right blinking number fig2. Number fig2 on the left side the display is number to be set. Number on the right side display is number newly selected. Pushing this switch continuously to the indicated number will set the right side of display. Then the left side numbers changes to lighting and left side number is same as right side number. After setting, the display returns to indicate the value of pitch speed. Through, in setting another function is canceled.

fig2. PITCH BEND RANGE SELECT

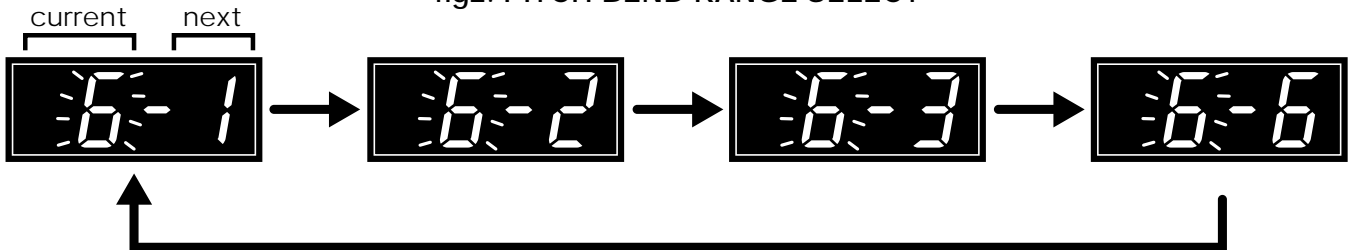

## ③ REVERSE SWITCH

Pushing REVERSE SWITCH, the display will indicate "ron" (REVERSE ON),LED above this switch light on. pushing this switch once more ,reverse function is canceled and the display indicate "rof"(REVERSE OFF), the LED light off.

## ④ MOTOR OFF SWITCH

Pushing this switch, the motor is disconnected from the servo drive and the turntable turns to until it stops naturally, and it's possible to change rotation motion of turntable by touching the side of turntable. The display will indicate "Sof" (SERVO OFF). Pushing this switch once more, the function of MOTOR OFF is canceled and the display indicates "Son"(SERVO ON). in condition of MOTOR OFF, Function of pitch fader, stick controller, reverse start/stop etc.....are canceled.

## ⑤ QUARTZ LOCK SWITCH

Pushing this switch , LED above this switch light on. The pitch is returned automatically to the predetermined speed (33-1/3 or 45rpm) in regardless of position of PITCH CONTROL FADER VOLUME. At this time ,the display indicates "Q ON" (QUARTZ ON) for 1 second. After that ,it indicates the value of pitch as "+00.0". By pushing this switch once more, the quartzlock is canceled and the LED lights off. Then the display indicates "Q OF" (QUARTZ OFF). In quartzlock, pitch bend function of stick controller is canceled. In case of power switch being on, beginning set is quartzlock off at 33 rpm.

## ⑥ STICK CONTROLLER

Moving the stick controller to the left ,the display indicate "FAS" (FAST) ,stick controller function is FAST FORWARD (FF), the pitch speed is up momentarily. Moving the stick controller to the right, the display indicate "SLO" (SLOW) ,stick controller function is SPEED DOWN ,the pitch speed is down momentarily. In quartzlock this function is still efficiency.

# REMOTE CONTROL

It is possible to control two turntables remotely.

- ① Prepare for 3.5mm monaural phone plug cable Turn on Sync ON/OFF SW.
- ② Connect REMOTE OUT JACK at the rear panel with another PDX-d3S REMOTE IN JACK at the rear panel by using the cable.
- ③ The player connected at the REMOTE OUT JACK is MASTER of the PDX-d3S. The player connected at the REMOTE IN JACK is the Slave of the PDX-d3S.
- ④ Pushing START/ STOP SWITCH of the master PDX-d3S will make the connection between master PDX-d3S and slave PDX-d3S. Then slave PDX-d3S acts the same as master PDX-d3S without touching slave PDX-d3S. Connecting the REMOTE IN JACK of third PDX-d3S with REMOTE OUT JACK of slave PDX-d3S, third PDX-d3S will also act the same as master PDX-d3S It is possible to connect a fourth PDX-d3S, to be controlled the same as master PDX-d3S by REMOTE CONTROL.

## CONNECTION

ex.

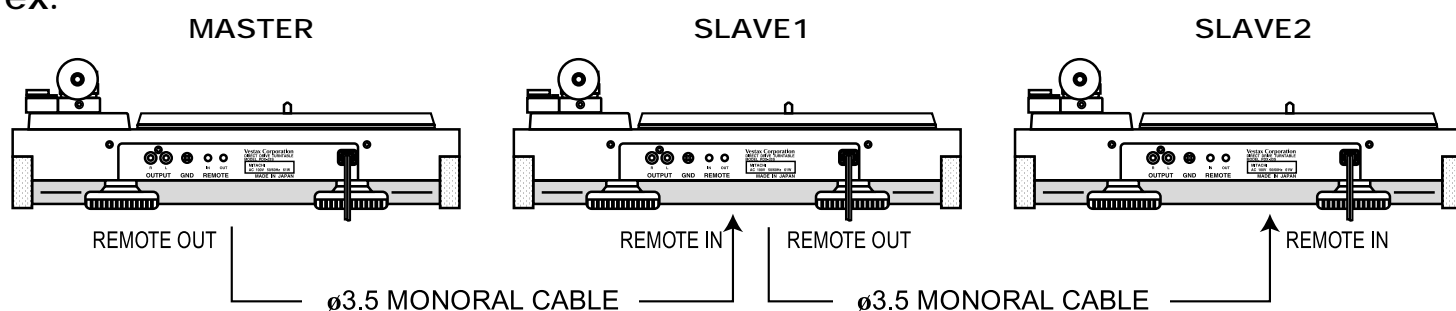

## SPECIFICATION

|           |                      |  |
|-----------|----------------------|--|
| TURNTABLE | MOTOR                | DIRECT DRIVE QUARTZ  |
|           | STARTING UP TIME     | 0.5sec ( 33 1/2 rpm ) 70°                                  |
|           | STARTING TORQUE      | 1.6kg cm   |
|           | BRAKING SYSTEM       | ELECTRONIC BRAKE   |
|           | RAMBLE ( S/N RATIO ) | 78dB ( IEC 98 WTD )  |
|           | SPEED                | 33 1/2 rpm, 45rpm  |
|           | PITCH                | ± 10% ( DETOUCHABLE 100mm FADER )                          |
| ARM       | WOW & FLUTTER        | 0.03% W.R.M.S.   |
|           | TYPE                 | ANTI SKIPPING TONE-ARM SYSTEM. TRACING HOLD BALANCE SYSTEM |
|           | EFFECTIVE LENGTH     | 230mm ± 1mm  |
|           | TRACKING ERROR       | +2° 32' ~ +0° 32'  |
|           | STYLUS PRESSURE      | ADJUSTMENT RANGE 0 ~ 7.0g                                  |
|           | LIGHT ( OPTIONAL )   | DETOUCHABLE MINI LIGHT DC12volt 100mA                      |
|           | SPEED LOCK           | QUARTZ LOCK  |
|           | REMOTE               | MOMENTARY START ( MINI JACK )                              |
|           | DIMENSION            | ( W ) 450mm X ( H ) 150mm X ( D ) 370mm                    |
|           | WEIGHT               | 9.5kg  |
| POWER     | AC120V or 230V       |  |