

BX-3

COMBO ORGAN

Owner's Manual

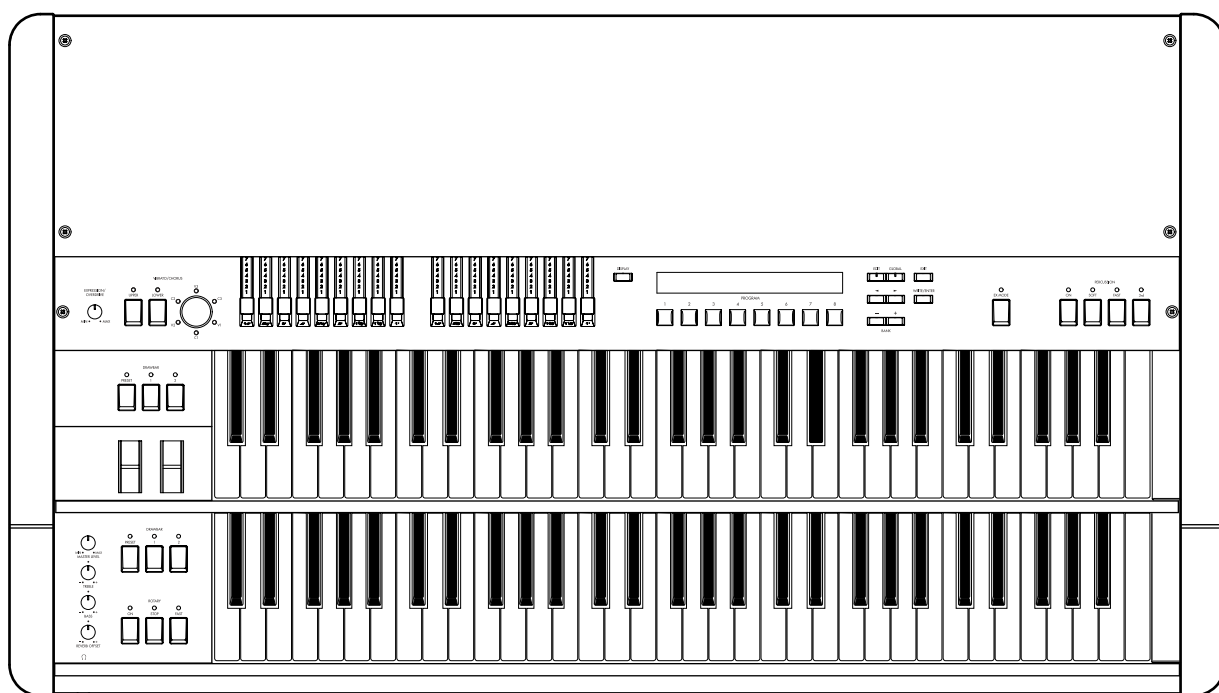

KORG

IMPORTANT SAFETY INSTRUCTIONS

- 1) Read these instructions.
- 2) Keep these instructions.
- 3) Heed all warnings.
- 4) Follow all instructions.
- 5) Do not use this apparatus near water.
- 6) No objects filled with liquids, such as vases, shall be placed on the apparatus.
- 7) Clean only with dry cloth.
- 8) Do not block any ventilation openings, install in accordance with the manufacturer's instructions.
- 9) Do not install near any heat sources such as radiators, heat registers, stoves, or other apparatus (including amplifiers) that produce heat.
- 10) Do not defeat the safety purpose of the polarized or grounding-type plug. A polarized plug has two blades with one wider than the other. A grounding type plug has two blades and a third grounding prong. The wide blade or the third prong are provided for your safety. If the provided plug does not fit into your outlet, consult an electrician for replacement of the obsolete outlet. (for U.S.A. and Canada)
- 11) Protect the power cord from being walked on or pinched particularly at plugs, convenience receptacles, and the point where they exit from the apparatus.
- 12) Only use attachments/accessories specified by the manufacturer.
- 13) Unplug this apparatus during lightning storms or when unused for long periods of time.
- 14) Refer all servicing to qualified service personnel. Servicing is required when the apparatus has been damaged in any way, such as power-supply cord or plug is damaged, liquid has been spilled or objects have fallen into the apparatus, the apparatus has been exposed to rain or moisture, does not operate normally, or has been dropped.
- 15) Do not install this equipment on the far position from wall outlet and/or convenience receptacle.
- 16) Do not install this equipment in a confined space such as a box for the conveyance or similar unit.
- 17) Use only with the cart, stand, tripod, bracket, or table specified by the manufacturer, or sold with this apparatus. When a cart is used, use caution when moving the cart/apparatus combination to avoid injury from tip-over.



WARNING:

TO REDUCE THE RISK OF FIRE OR ELECTRIC SHOCK DO NOT EXPOSE THIS PRODUCT TO RAIN OR MOISTURE.

| | | |
|---|---|---|
|  | CAUTION RISK OF ELECTRIC SHOCK DO NOT OPEN |  |
| AVERTISSEMENT: RISQUE DE CHOC ÉLECTRIQUE—NE PAS OUVRIR. | | |
| 注意 感電の恐れあり、キャビネットをあけるな | | |

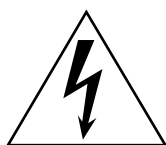

The lightning flash with arrowhead symbol within an equilateral triangle, is intended to alert the user to the presence of uninsulated "dangerous voltage" within the product's enclosure that may be of sufficient magnitude to constitute a risk of electric shock to persons.



The exclamation point within an equilateral triangle is intended to alert the user to the presence of important operating and maintenance (servicing) instructions in the literature accompanying the product.

THE FCC REGULATION WARNING (for U.S.A.)

This equipment has been tested and found to comply with the limits for a Class B digital device, pursuant to Part 15 of the FCC Rules. These limits are designed to provide reasonable protection against harmful interference in a residential installation. This equipment generates, uses, and can radiate radio frequency energy and, if not installed and used in accordance with the instructions, may cause harmful interference to radio communications. However, there is no guarantee that interference will not occur in a particular installation. If this equipment does cause harmful interference to radio or television reception, which can be determined by turning the equipment off and on, the user is encouraged to try to correct the interference by one or more of the following measures:

- Reorient or relocate the receiving antenna.
- Increase the separation between the equipment and receiver.
- Connect the equipment into an outlet on a circuit different from that to which the receiver is connected.
- Consult the dealer or an experienced radio/TV technician for help.

Unauthorized changes or modification to this system can void the user's authority to operate this equipment.

CE mark for European Harmonized Standards

CE mark which is attached to our company's products of AC mains operated apparatus until December 31, 1996 means it conforms to EMC Directive (89/336/EEC) and CE mark Directive (93/68/EEC).

And, CE mark which is attached after January 1, 1997 means it conforms to EMC Directive (89/336/EEC), CE mark Directive (93/68/EEC) and Low Voltage Directive (73/23/EEC).

Also, CE mark which is attached to our company's products of Battery operated apparatus means it conforms to EMC Directive (89/336/EEC) and CE mark Directive (93/68/EEC).

Thank you for purchasing the Korg **BX-3** combo organ. To ensure trouble-free enjoyment, please read this manual carefully and use the instrument as directed.

About this owner's manual

How this manual is organized, and how to use it

Please read this manual carefully to learn important points and basic operation.

“**Introduction**” explains the features of the BX-3 and their function, and how to make connections.

“**Quick Start**” explains how to play the demo songs, and perform basic operations.

“**Basic functions**” explains basic operations for playing the BX-3.

“**Parameters**” explains the operation and settings for each parameter, organized by mode. Refer to this section when an unfamiliar parameter is displayed, or when you want to learn more about a function.

“**Appendix**” explains how to connect a MIDI sequencer or computer, or perform a data dump. A list of the built-in sounds of the BX-3, and specifications etc. are also provided.

Printing conventions in this manual

Keys and knobs ... []

Keys and knobs etc. on the front panel of the BX-3 are enclosed in square brackets [].

Parameters

Parameters that appear in the display are enclosed in quotation marks “ ”.

p. ■

This indicates a page for reference.

symbol

This symbol indicates a cautionary note.

symbol

This symbol indicates a useful hint or application.

Display screen

The parameter values and program names etc. appearing in the screens printed in this manual are only examples; they will not necessarily match the values or names that appear in the screen of your BX-3.

MIDI-related conventions

CC# is an abbreviation for Control Change Number. In the context of a MIDI message, all numbers in square brackets [] are in hexadecimal notation.

Table of Contents

| | | | |
|--|-----------|---|-----------|
| Introduction | 5 | 6. Effects | 19 |
| 1. About the BX-3 | 5 | Reverb | 19 |
| Main features | 5 | Vibrato and chorus | 19 |
| The modes of the BX-3 | 5 | Overdrive | 19 |
| 2. Parts of the BX-3 and what they do | 6 | 7. Saving your data | 19 |
| Front panel | 6 | Writing to internal memory | 19 |
| Rear panel | 9 | Writing a program | 19 |
| Connections | 10 | Writing the Global parameters | 20 |
| 1. Power cable connections | 10 | MIDI data dump | 20 |
| 2. OUTPUT jack connections | 10 | 8. Editing | 20 |
| 3. Pedal connections | 10 | Editing the sound | 20 |
| 4. MIDI connections | 10 | Other parameters | 21 |
| | | Editing the drawbar parameters | 21 |
| | | Normal mode | 21 |
| | | EX mode | 21 |
| | | Copying drawbar parameters | 21 |
| | | Copying a program | 22 |
| | | Swapping two programs | 22 |
| | | Editing the name of a program | 22 |
| Quick Start | 11 | Parameters | 24 |
| 1. Listening to the demo songs | 11 | 1. Normal Edit mode / EX Edit mode | 24 |
| 2. Normal mode | 11 | 2. Global mode | 30 |
| Selecting a program | 11 | | |
| Playing | 11 | | |
| Playing using the Program's drawbar settings | 11 | | |
| Using the Drawbar 1 and 2 settings | 12 | | |
| 3. EX mode | 12 | | |
| Selecting a program | 12 | | |
| Playing | 12 | | |
| Playing Using the Program's drawbar settings | 12 | | |
| Using the Drawbar 1 and 2 settings | 13 | | |
| Basic functions | 14 | Appendices | 36 |
| 1. About the display | 14 | 1. How the drawbars work | 36 |
| Switching the display | 14 | 2. MIDI applications | 36 |
| Normal mode | 14 | About MIDI | 36 |
| EX mode | 14 | Connecting an external MIDI sequencer or | 36 |
| Drawbar levels and icons | 14 | computer | 36 |
| Shortcuts | 15 | MIDI data dump | 37 |
| Normal Edit mode / EX Edit mode | 15 | Transmission | 37 |
| Global mode | 15 | Reception | 38 |
| 2. About the programs | 16 | MIDI messages that the BX-3 transmits and | 38 |
| How a program is structured | 16 | receives | 38 |
| 3. Restoring the factory settings | 16 | 3. Voice name list | 40 |
| Initializing one program | 16 | Normal mode programs | 40 |
| Initializing all programs | 16 | EX mode programs | 40 |
| Initializing the Global parameters | 17 | Demo song names | 40 |
| Initializing programs and Global parameters | 17 | 4. Troubleshooting | 41 |
| 4. Percussion | 17 | 5. Operation of included Expression | |
| Normal mode | 17 | pedal | 42 |
| Checking the "DB Preset's Perc" parameter | 17 | 6. Specifications and options | 43 |
| EX mode | 18 | 7. Assembling the stand | 44 |
| EX Percussion in Drawbar 2 | 18 | 8. MIDI implementation chart | 47 |
| 5. Rotary | 18 | | |

Introduction

1. About the BX-3

Main features

The BX-3 dual-manual combo organ contains a **tone wheel organ modeling tone generator** that produces the distinctive sound of a tone wheel organ. It provides two 61-note keyboards, allowing you to mimic the performance techniques of a traditional tone wheel organ.

Korg's **REMS** technology is used to create spatial effects such as rotary speaker, chorus/vibrato, and reverb, faithfully simulating the modulated sounds produced by the turning rotor and horn, the natural overdrive, and chorus/vibrato to produce the authentic combo organ sound. The BX-3 is all you need to enjoy real organ sound.

By operating the two sets of **drawbars** you can modify the sound in realtime while you play. The sound is created using one set of drawbars **in Normal mode**, or by using both sets **in EX mode**. In EX mode, you can introduce additional tonal and percussion harmonics, letting you produce new sounds unavailable until now.

A conventional keyboard does not sound until a key is pressed down all the way, but the BX-3 will sound even when a key is pressed lightly. The notes will "speak" very rapidly, as will the glissandi and trills you play.

The BX-3 accurately reproduces the distinctive **percussive** attack associated with certain classic tone wheel organs. You can also adjust the settings to obtain the "contact arcing" or **key click** effect when you press or release a key, providing the sense of attack unique to a tone wheel organ.

There are **128 internal programs** (Normal mode: 64, EX mode: 64) that let you enjoy a variety of organ sounds.

The BX-3 has two keyboards, **UPPER** and **LOWER**. A separate MIDI channel can be assigned to each keyboard.

To create the sound, the BX-3 uses the two sets of drawbars (Drawbar 1 and Drawbar 2) on the front panel, as well as the drawbar settings specified by the program. Drawbar settings can also be made via MIDI.

The keys in the DRAWBAR SELECT section let you choose which set of drawbars is active (see the diagram).

What is REMS?

REMS (Resonant structure and Electronic circuit Modeling System) is KORG's proprietary sound modeling technology which precisely reproduces the complex character and nature of both acoustic and electric instruments as well as electronic circuits in real world environments. REMS emulates a wide variety of sound generation characteristics including instrument bodies, speakers & cabinets, acoustic fields, microphones, vacuum tubes, transistors, etc.

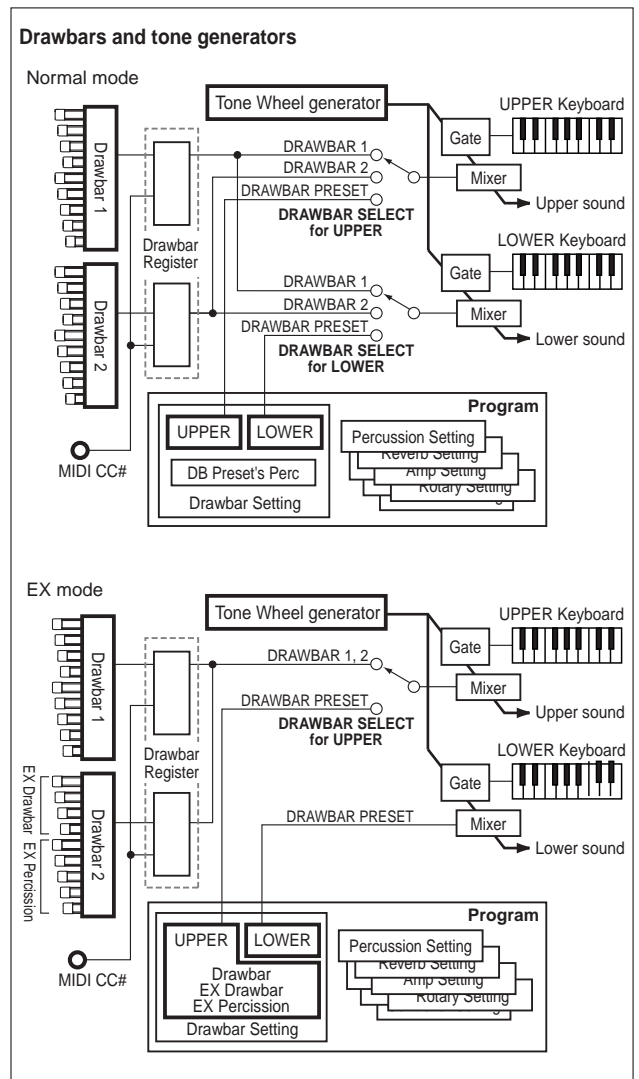

The modes of the BX-3

Normal mode and EX mode

In these modes you can select and play programs. The main differences between Normal mode and EX mode are given below.

Normal mode

- The sound is created by one set of drawbars

EX mode

- The sound is created by two sets of drawbars

Normal Edit mode and EX Edit mode

In this mode you can edit the program parameters of Normal mode or EX mode.

Global mode

In this mode you can make settings that affect the entire BX-3, such as master tune, transpose, and global MIDI channel.

2. Parts of the BX-3 and what they do

Front panel

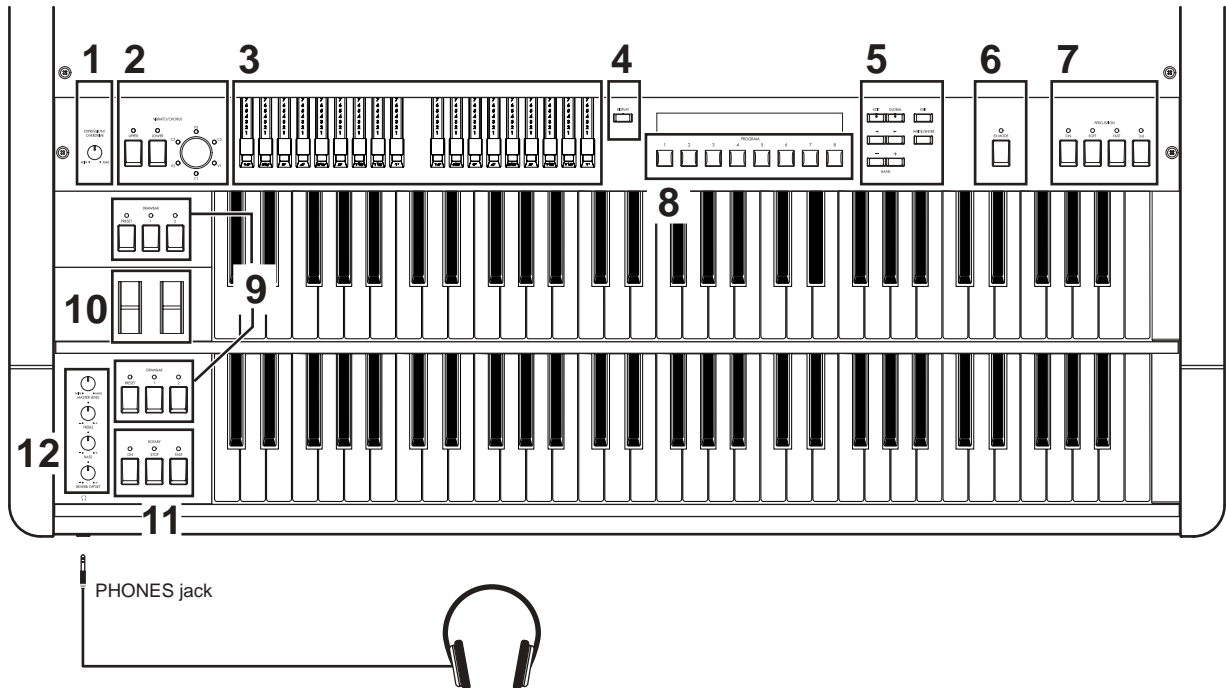

1. [EXPRESSION/OVERDRIVE] knob

This simultaneously adjusts the volume and distortion. At low volumes, the low frequency and high frequency regions will be emphasized slightly.

2. VIBRATO/CHORUS section

[UPPER] key, [LOWER] key

These keys select the keyboard to which vibrato or chorus will be applied. When you press a key to turn it on, its LED will light.

[VIBRATO/CHORUS] knob

V1-V3: Vibrato will be applied, and V3 produces the maximum effect.

C1-C3: Chorus will be applied, and C3 produces the maximum effect.

3. DRAWBAR section

Drawbar 1, Drawbar 2

Drawbar 1 is at the left, and Drawbar 2 at the right. Each bar is assigned a pitch (footage), and you can adjust the volume of that pitch by pulling the bar toward yourself. The overall character of the sound is determined by how far each bar is pulled out.

In EX mode, **Drawbar 2** is used to control **EX Drawbar** and **EX Percussion**. For details, refer to "Playing the BX-3" (p.13).

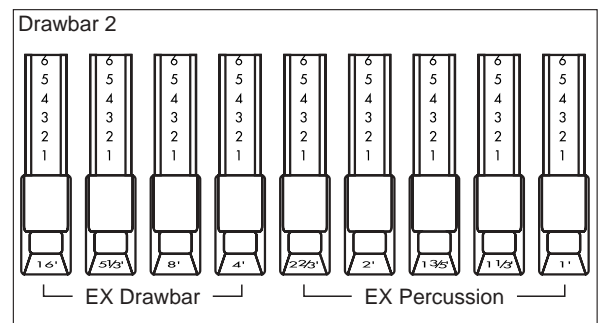

4. [DISPLAY] key

The contents of the display will change each time you press this key.

The display will differ between Normal mode and EX mode. For details, refer to "1. About the display" (p.14).

5. [EDIT] key

Press this key to enter Normal Edit mode or EX Edit mode

In Normal mode, pressing this key will enter Normal Edit mode. In EX mode, pressing this key will enter EX Edit mode.

[GLOBAL] key

Press this key to enter Global mode.

[EXIT] key

Press this key to exit from Normal Edit mode, EX Edit mode, or Global mode, or to cancel an operation such as program write, copy, swap, or data dump.

[WRITE/ENTER] key

Press this key to execute an operation such as program write, copy, swap, or data dump.

[√]/[▶] keys

In Normal Edit mode, EX Edit mode, and Global mode, use these keys to move to the previous or next page, or to move the cursor to the left or right in the display.

[−]/[+] keys

In Normal mode and EX mode, use these keys to select banks of preset programs.

In Normal Edit mode, EX Edit mode, and Global mode, use these keys to edit the value of a parameter.

Pressing and releasing a key will change the value in steps of 1, and holding down a key will change the value continuously.

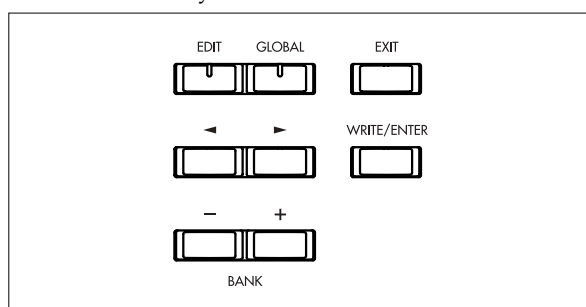

6. [EX MODE] key

Press this key to enter EX mode.

7. PERCUSSION section

Here you can add an attack to the beginning of the notes, making the sound more crisp.

For details, refer to "4. Percussion" (p.17).

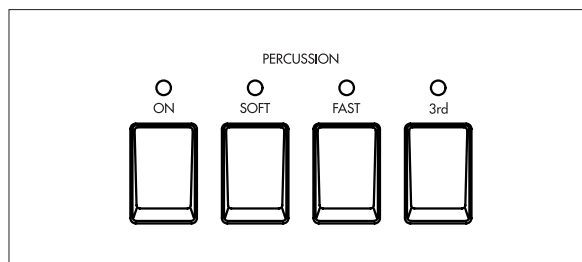

[ON] key

This switches percussion on/off.

When this is off, the [3rd] key, [SOFT] key, and [FAST] key will have no effect.

LED lit: Percussion will be on.

[SOFT] key

This switches the percussion volume (soft or normal).

LED lit: The percussion volume will be lowered.

[FAST] key

This switches the percussion decay speed (fast or slow).

LED lit: The decay will be faster.

[3rd] key

This switches the pitch of the percussion sound between the 3rd and 2nd harmonics.

When you are using the EX mode drawbars, this setting is assigned to the 2-2/3' drawbar of the EX Percussion (the five right-most bars of Drawbar 2).

LED lit (3rd): A pitch one octave and a fifth higher (corresponding to 2-2/3') will be assigned to the percussion effect.

LED dark (2nd): A pitch one octave higher (corresponding to 4') will be assigned to the percussion effect.

8. PROGRAM [1]–[8] keys

In Normal mode and EX mode, these keys are used to directly select a preset program from within a bank.

In Normal Edit mode, EX Edit mode, and Global mode, these keys are used as **shortcuts** to select parameters (p.15).

9. DRAWBAR SELECT section

The upper three drawbar select keys are for the upper keyboard, and the lower three are for the lower keyboard. When you press a key to turn it on, its LED will light.

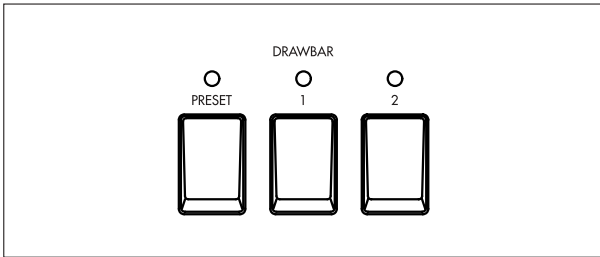

Use these keys to select the drawbar settings that will be played by the upper or lower keyboards. If you select the **[DRAWBAR 1]** key, the keyboard will play the settings of the front panel Drawbar 1 section. The Drawbar 2 settings will be used if you select the **[DRAWBAR 2]** key, and the drawbar parameters specified by the program will be used if you select the **[PRESET DRAWBAR]** key. If you press the **[PRESET DRAWBAR]** key when its LED is blinking or dark, the drawbar parameter settings will be shown in the display for approximately 1 second. In EX mode, the **[PRESET DRAWBAR]** key will automatically be selected for the lower keyboard (neither of the other Drawbar settings can be selected).

10. Pitch Bend wheel, Modulation wheel

These wheels let you control tone, pitch, and volume etc. in realtime while you play. The bender wheel is at the left, and the modulation wheel at the right.

Pitch Bend wheel

Move this wheel away from yourself to raise the pitch. Move it toward yourself to lower the pitch.

Modulation wheel

Move this wheel away from or toward yourself to apply the effect that is assigned to the modulation wheel.

11. ROTARY section

Here you can control the rotary effect. For details, refer to "5. Rotary" (p.18).

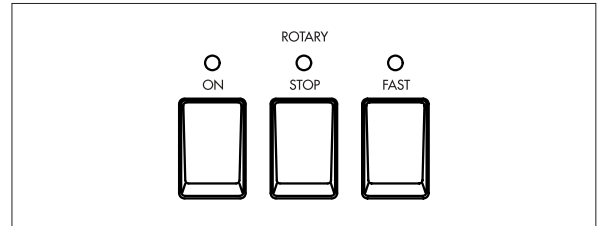

[ON] key

This key turns the rotary speaker effect on or off. When this is off, pressing the **[FAST]** or **[STOP]** keys will have no effect. **LED lit:** The rotary speaker effect is on.

[STOP] key, [FAST] key

These keys control the rotary speaker. **When the [STOP] key LED is dark:** The **[FAST]** key will switch the rotary speaker between fast and slow. The rotary speaker will turn rapidly when you make the **[FAST]** key LED light. The rotary speaker will turn slowly when you make the **[FAST]** key LED go dark. **When the [STOP] key LED is lit:** The **[FAST]** key will switch the rotary speaker between fast and stopped. The rotary speaker will turn rapidly when you make the **[FAST]** key LED light. The rotary speaker will stop turning when you make the **[FAST]** key LED go dark. **When the [FAST] key LED is dark:** The **[STOP]** key will switch the rotary speaker between slow and stopped. The rotary speaker will stop turning when you make the **[STOP]** key LED light. The rotary speaker will turn slowly when you make the **[STOP]** key go dark.

12. AMP section

[MASTER LEVEL] knob

Use this knob to adjust the volume as appropriate for the equipment to which the BX-3 is connected. Use the **[EXPRESSION/OVERDRIVE]** knob and a connected expression pedal to adjust the volume and distortion of the sound, and then use this knob to set the final output level.

[TREBLE] knob

Adjusts the high-frequency level.

[BASS] knob

Adjusts the low-frequency level.

[REVERB OFFSET] knob

Adjust the reverb depth. When this knob is at the center position, the reverb will be the depth specified by the program. When this knob is turned to the far left there will be no reverb, and when turned to the far right the reverb will be deeper.

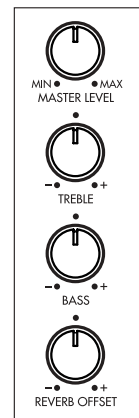

Rear panel

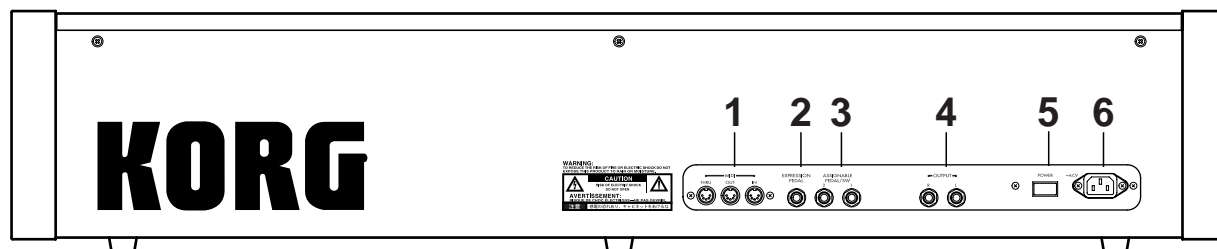

1. MIDI IN connector

Musical data and sound settings etc. can be received at this connector.

Use this connector when you wish to play the BX-3's tone generator from a connected MIDI device.

MIDI OUT connector

Music data and sound settings etc. can be transmitted from this connector.

Use this connector when you wish to control a connected MIDI device.

MIDI THRU connector

Music data and sound settings etc. received at the MIDI IN connector are re-transmitted without change from this connector.

Use this connector when you wish to connect multiple MIDI devices.

2. EXPRESSION PEDAL jack

Connect the included expression pedal to this jack. For details on the function of the expression pedal, refer to "5. Operation of included Expression pedal" (p.42).

3. ASSIGNABLE PEDAL/SW 1, 2 jacks

On/off-type pedal switches (separately sold Korg PS-1 pedal switches), or separately sold Korg EXP-2 foot controllers or XVP-10 expression/volume pedals can be connected to these jacks.

4. OUTPUT L, R jacks

Connect these jacks to the INPUT jacks of your amp or mixer.

These are unbalanced phone jacks.

When connecting in stereo, use the L and R jacks.

When connecting in monaural, use the L jack.

5. Power switch

This turns the power on/off.

6. AC power inlet

Connect the included power cable here.

After connecting the power cable to the BX-3, plug it into an AC outlet.

Connections

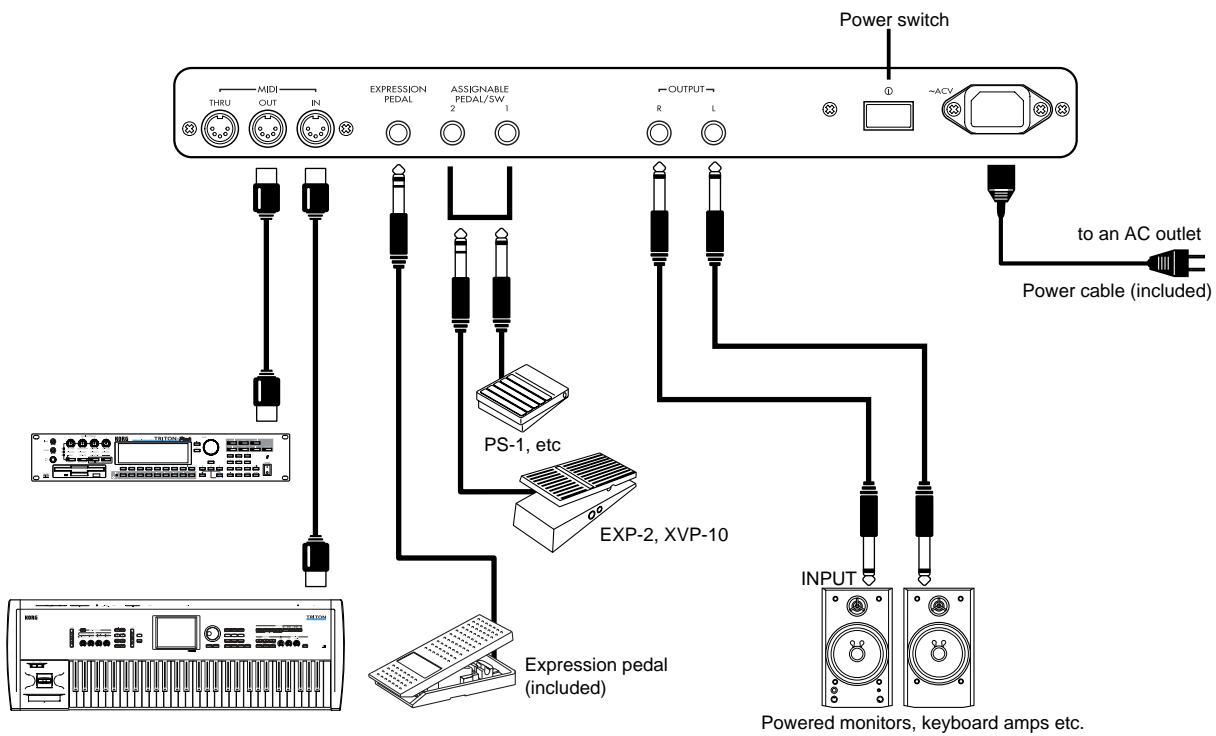

⚠ Be sure that the power is off before you make any connections. Improper use can damage your speaker system etc., or may cause a malfunction.

1. Power cable connections

Connect the included power cable to the AC power inlet of the BX-3, and then plug the other end of the cable into an AC outlet.

2. OUTPUT jack connections

Connect powered monitors, keyboard amps, or your audio system to output the sound of the BX-3.

⚠ If you connect the BX-3 to a stereo audio amp, high-volume playing may damage your speaker system. Be careful not to raise the volume excessively.

Connect the OUTPUT L, R jacks to the INPUT jacks of your powered monitors etc.

When connecting in stereo, use the L and R jacks. When connecting in mono, use the L jack. We recommend that you use stereo connections whenever possible.

3. Pedal connections

Pedal switch connections

The rotary speaker effect, vibrato/chorus on/off, and program selection can be controlled by a foot switch.

The function to be controlled can be specified by the parameters of Normal Edit mode, EX Edit mode, and Global mode.

Connect a separately sold Korg PS-1 pedal switch to the ASSIGNABLE PEDAL/SW jack of the rear panel.

Expression pedal connections

A pedal can be used to control the volume, etc.

The function to be controlled can be specified by the parameters of Normal Edit mode, EX Edit mode, and Global mode.

Connect the included expression pedal to the EXPRESSION PEDAL jack, and a separately sold Korg EXP-2 foot controller or XVP-10 expression/volume pedal to the ASSIGNABLE PEDAL/SW jack of the rear panel.

4. MIDI connections

MIDI connections allow you to use the keyboard and controllers (drawbars etc.) of the BX-3 to control an external MIDI tone generator, or use another MIDI keyboard or sequencer to play the tone generator of the BX-3.

Use a MIDI cable to connect the MIDI connector of the BX-3 to the MIDI connector of the external MIDI device. For details refer to "2. MIDI applications" (p.36).

Quick Start

1. Listening to the demo songs

Here's how to listen to the demo songs.

The BX-3 contains nine demo songs. For the song titles, refer to "3. Voice name list" (p.40).

1. **Turn on the power.**
2. **Press the [GLOBAL] key.**
The [GLOBAL] key LED will light.
3. **Press the PROGRAM [8] key, and then press the [WRITE/ENTER] key.**



IY's Groovin' ↵

4. **Press the [WRITE/ENTER] key once again.**
The demo will begin playing.
When the first song ends, the next song will begin.
5. **To stop the performance, press the [EXIT] key.**

tips After pressing the [WRITE/ENTER] key in step 3, you can press the [-] or [+] keys to select a specific demo song .

2. Normal mode

Selecting a program

Here's how you can select and play program C-3 (program 3 of bank C).

1. **Make sure that you are in Normal mode.**
The program number will be shown at the left of the display.



A-6! Joey's LH

If you are not in Normal mode (i.e., if the [EX MODE] key, [EDIT] key, or [GLOBAL] key LEDs are lit) press the lit key once. If the [EDIT] key or [GLOBAL] key LEDs are lit, you can also return to Normal mode by pressing the [EXIT] key.

tips When you turn on the power, you will automatically be in Normal mode.

2. **[Press the [-] or [+] key to select bank C, and press the PROGRAM [3] key.**

Program C-3 will be selected, and the display will show the program number and program name.



C-3: Whyter Shade

Playing

Playing using the Program's drawbar settings

Here's how to use the drawbar settings stored as part of a program instead of using the front panel Drawbar 1 or 2 settings.

1. **Select a program in Normal mode.**
Use the [-] [+] keys to select the bank, and the PROGRAM [1]–[8] keys to select the number.
2. **In both the upper and lower DRAWBAR SELECT sections, press the [DRAWBAR PRESET] key to make the key LED light.**

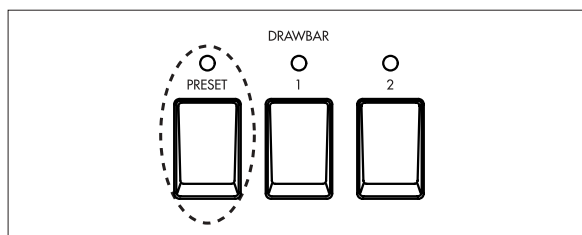

3. **Play the keyboard.**
The upper keyboard will use the "UPPER" parameter settings of the program, and the lower keyboard will use the "LOWER" parameter settings of the program.

Using the Drawbar 1 and 2 settings

1. Make sure that you are in Normal mode.



2. In the DRAWBAR SELECT section located at the left of the upper keyboard, press the [DRAWBAR 2] key.

The key LED will light.

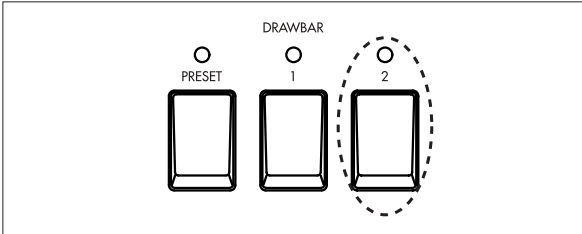

Now you can use the front panel Drawbar 2 section to adjust the tone of the upper keyboard.

3. While playing the upper keyboard, pull out the front panel Drawbar 2 bars to create the sound.

When you pull out each bar of Drawbar 2, the pitch (footage) printed on that bar will be added to the sound produced by the key. The volume of that pitch will depend on how far the bar is pulled out. In this way, the overall tone is determined by the combination of bars that are pulled out.

For details on the pitches that are assigned to the bars, refer to "1. How the drawbars work" (p.36).

4. In the DRAWBAR SELECT section located at the left of the lower keyboard, press the [DRAWBAR 1] key.

The key LED will light.

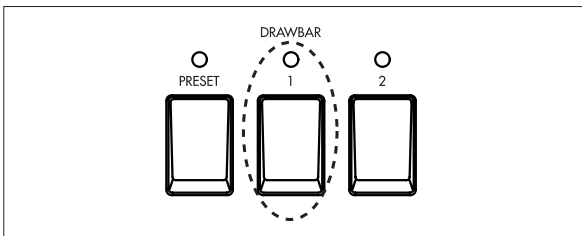

Now you can use the front panel Drawbar 1 section to adjust the tone of the lower keyboard.

5. While playing the lower keyboard, pull out the front panel Drawbar 1 bars to create the sound.

When you pull out each bar of Drawbar 1, the pitch (footage) printed on that bar will be added to the sound produced by the key. The volume of that pitch will depend on how far the bar is pulled out. In this way, the overall tone is determined by the combination of bars that are pulled out.

For details on the pitches that are assigned to the bars, refer to "1. How the drawbars work" (p.36).

6. Let's try selecting a program .

Use the [-] [+] keys to select the bank, and PROGRAM [1]-[8] keys to select the number.

When you select a different program, the settings saved with the program (other than the drawbar parameters) will be recalled. In other words, the Drawbar 1 and 2 settings will remain in effect, and the other settings (for example, wheel type, percussion volume, reverb time, rotary speaker horn and rotor speed, etc.) of the selected program will be applied.

3. EX mode

Selecting a program

Here's how you can select and play program B-3 (number 3 of bank B).

1. From Normal mode, press the [EX MODE] key.

The [EX MODE] key LED will light, indicating you are in the EX mode.

The display will show an "E" at the left, and the program number.



If an LED is lit for a mode other than EX mode (i.e., if the [EDIT] key or [GLOBAL] key LED is lit), press the lit key once, or press the [EXIT] key and then press the [EX MODE] key.

2. Use the [-] [+] keys to select bank B, and press the PROGRAM [3] key.

Program B-3 will be selected, and the display will show the program number and program name.



Playing

Playing Using the Program's drawbar settings

Here's how to play the drawbar settings saved with the program, instead of using the Drawbar 1 and 2 settings of the front panel.

1. In EX mode, select a program.

Use the [-] [+] keys to select a bank, and PROGRAM [1]-[8] keys to select a number.

2. In the DRAWBAR SELECT section located at the left of the upper keyboard, press the [DRAWBAR PRESET] key to make the key LED light.

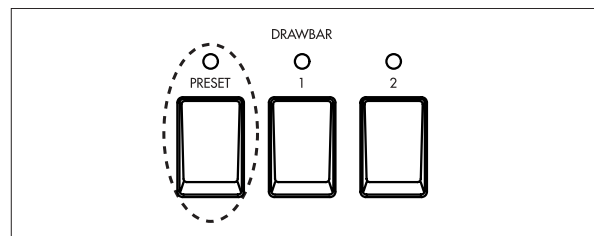

In the DRAWBAR SELECT section located at the left of the lower keyboard, the [DRAWBAR PRESET] key will be selected automatically. (The other two keys cannot be selected in the EX mode.)

3. Play the keyboard.

The upper keyboard will use the Drawbar 1 and EX Drawbar settings of the "EX DRAWBAR & PERCUSSION" parameters, and the lower keyboard will use the settings of the "EX LOWER" parameters.

Using the Drawbar 1 and 2 settings

The **upper keyboard** will use both sets of Drawbars (1 and 2) on the front panel. Drawbar 2 is assigned to footages and percussion settings for the EX mode, allowing you to create richer and more expressive sounds than in Normal mode.

The **lower keyboard** will use the drawbar parameter settings that are specified by the program.

1. In EX mode, press the [DRAWBAR 1] key or [DRAWBAR 2] key of the upper DRAWBAR SELECT section. Make sure that the LEDs of both keys are lit.

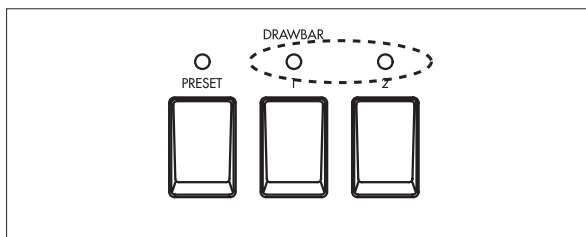

2. While playing the upper keyboard, pull out the drawbars of front panel Drawbar 1 and 2 to create the sound.

Drawbar 1 adjusts the volume of the footage printed on each bar.

In the **Drawbar 2** section, **EX Drawbar** (the four left bars) adjust the volume of the footage, and **EX Percussion** (the five right bars) adjust the volume of percussion.

Each bar is assigned as follows.

EX Drawbars

16'-4': The footage that is assigned to each of these bars is specified by the "Ex Drawbar Type" parameters in EX Edit mode. The content of each type is specified by the Global mode parameters "Ex Drawbar Type 1-1" through "Ex Drawbar Type 4-4." If you want to check the footage that is assigned to each bar, use EX Edit mode to check which type is used, and use Global mode to check the settings for each.

EX Percussion

2-2/3': 2-2/3' is assigned when the PERCUSSION section [3rd] key LED is lit, and 4' is assigned when the LED is dark.

2': 16' is assigned.

1-3/5': 5-1/3' is assigned.

1/1-3': The footage assigned to the 16' EX Drawbar is assigned. However, EX Drawbar 16' is assigned a footage by the EX Edit mode "Ex Drawbar Type" parameter, as described above. If you want to check the footage that is actually assigned to this bar, use EX Edit mode to check which type is used, and use Global mode to check the settings for each.

1': The footage assigned to the 5-1/3' EX Drawbar is assigned. However, 5-1/3' of Drawbar 2 is assigned a footage by the EX Edit mode parameter "Ex Drawbar Type," as described above. If you want to check the footage that is actually assigned to this bar, use EX Edit mode to check which type is used, and use Global mode to check the settings for each.

3. Play the lower keyboard.

The lower keyboard will automatically use the sound of the drawbar parameters that are preset by the program, and in the lower DRAWBAR SELECT section, the [PRESET PROGRAM] key LED will light (the other two keys cannot be selected).

tips If you want to change the preset drawbar settings, edit the parameters in EX Edit mode. For details, refer to "Editing the drawbar parameters" (p.21).

4. Selecting a different program.

Use the [-] [+] keys to select the bank, and the PROGRAM [1]-[8] keys to select the number.

When you select a different program, the program parameters other than the drawbar settings will be recalled and assigned to the sound.

tips The lower keyboard will automatically use the drawbar parameter settings that are specified by the program, so if you want to change the sound of the lower keyboard while you play, you can prepare several programs that differ only in the drawbar parameter settings, and switch between these programs while you play.

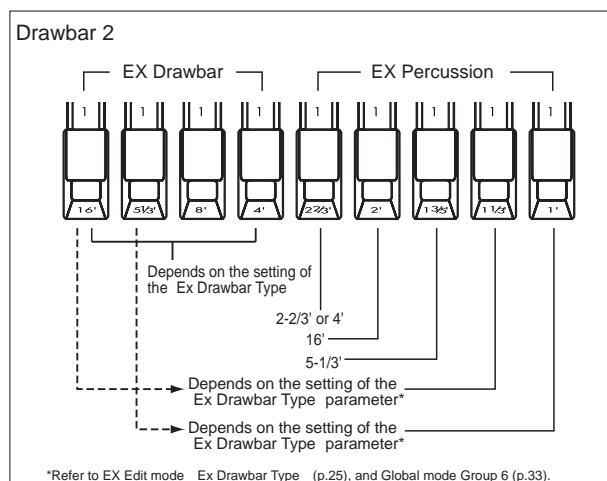

Basic functions

1. About the display

Switching the display

Each time you press the [DISPLAY] key, the contents of the display will change as follows.

Normal mode

When you are in the Normal mode, the display will show the **program number and program name**.

When you press the [DISPLAY] key, the display will show the **settings of the "UPPER" parameters (drawbar parameters for the upper keyboard)** specified by the program.

When you press the [DISPLAY] key again, the display will show the **settings of the "LOWER" parameters (drawbar parameters for the lower keyboard)**.

When you press the [DISPLAY] key once again, the **program number and program name** display will reappear.

tips Front panel Drawbar 1 and 2 settings can be changed not only by moving the bars manually, but also by receiving MIDI control change messages. If MIDI control changes are received to modify the sound, the "LOWER" parameter display will show the values as follows.

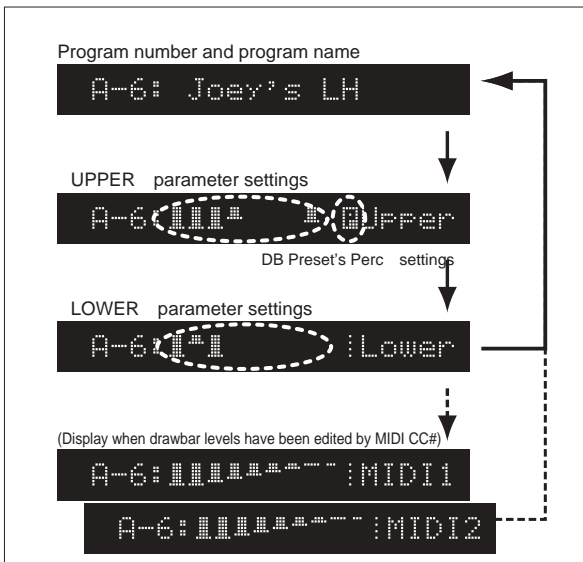

EX mode

When you are in the EX mode, the display will show the **program number and program name**.

When you press the [DISPLAY] key, the display will show the **settings of the "EX DRAWBAR & PERCUSSION" parameters Drawbar 1 and EX Drawbar** that are specified by the program.

When you press the [DISPLAY] key again, the display will show the **settings of the "EX Percussion" parameters**.

When you press the [DISPLAY] key again, the display will show the **settings of the "EX LOWER" parameters**.

When you press the [DISPLAY] key yet another time, the **program number and program name** display will reappear.

tips If MIDI control changes were received to change the sound, these values will be displayed following the "EX LOWER" parameter display, in the same way as for Normal mode.

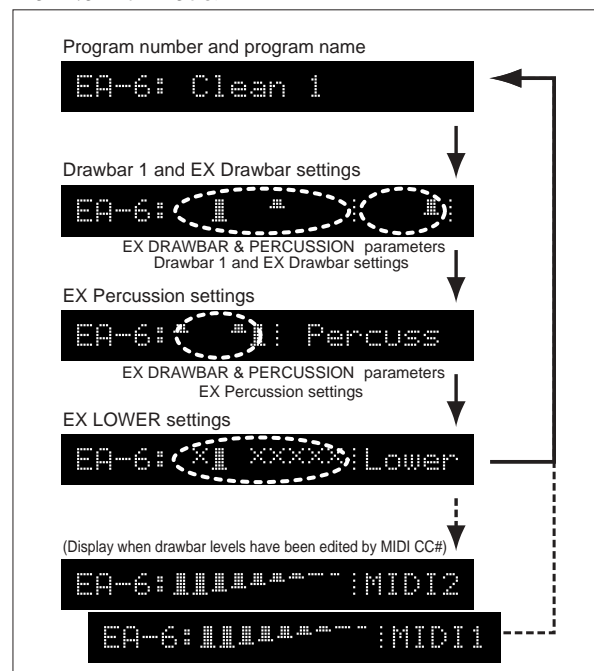

Drawbar levels and icons

: Drawbar levels

The above illustration shows the drawbar levels. At a level of 8 (maximum), the display will be as shown at the far left. At a level of 0 (minimum), nothing will be displayed, as in the far right of the illustration above.

: Enter icon

This will be displayed when writing or copying a program.

When this icon is displayed, pressing the [WRITE/ENTER] key will execute the operation.

: Speaker icon

This will be displayed when writing or copying a program.

This icon means that you can play the keyboard to hear the sound of the program indicated by the icon.

Percussion icon

This indicates that the “DB Preset’s Perc” parameter is set to Ena (Enable).

If this is set to Ena, you can use percussion in the upper keyboard if [DRAWBAR PRESET] is selected for the upper keyboard in Normal mode. For details, refer to “4. Percussion” (p.17).

Shortcuts

Normal Edit mode, EX Edit mode, and Global mode contain numerous parameters and detailed settings. In each mode, related parameters are organized into eight groups (Group 1–Group 8).

After entering a mode, you can access a parameter by pressing the [✓] or [▶] keys to step through the parameters one by one, but if you know the group that contains the desired parameter, it is convenient to use a shortcut key.

After you enter Normal Edit mode, EX Edit mode, or Global mode, press one of the PROGRAM [1]–[8] keys and the first parameter in that group will appear in the display. Press the [✓] or [▶] keys to view the preceding or following parameter.

When you press one of the PROGRAM [1]–[8] keys, the group name corresponding to that key will appear in the display.

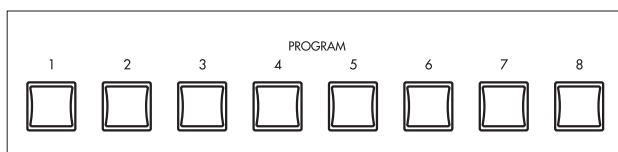

The functions in each group are described below.

Normal Edit Mode / EX Edit Mode

- Group 1: Specifies the output level, tone wheel noise, click level etc.
- Group 2: Specifies the drawbar levels and EX drawbar type.
- Group 3: Specifies how the BX-3 will respond to the PERCUSSION section controls.
- Group 4: Specifies amp settings.
- Group 5: Adjusts reverb settings.
- Group 6: Specifies rotary speaker settings.
- Group 7: Specifies settings for the modulation wheel, and specify the functions of the ASSIGNABLE PEDAL/SW jacks.
- Group 8: Edits the program name.

Global Mode

- Group 1: Specifies the master tuning, the expression pedal function, the pedal switch function, the pitch bend range, and the keyboard triggering type etc.
- Group 2: Specifies the MIDI channels.
- Group 3: Set MIDI filtering and Local on/off.
- Group 4: Specifies the MIDI control change numbers that will be used to transmit and receive drawbar settings.
- Group 5: Specifies the MIDI control change numbers that will be assigned to the front panel keys and wheels, and to connected pedals.
- Group 6: Specifies the EX drawbar types.
- Group 7: Copy, swap, or initialize programs, execute

a data dump, make settings for the DRAWBAR SELECT section, calibrate a connected pedal, and adjust the settings for the wheel break function.

- Group 8: Use this parameter to play the demo songs.

Normal Edit mode / EX Edit mode

The contents of the display will depend on which parameters of which group were displayed when you press the [DISPLAY] key.

The following information is displayed when you press the [DISPLAY] key.

- Group 1: The program name will be displayed.
- Group 2 “UPPER,” “LOWER,” “EX DRAWBAR & PERCUSSION,” “EX LOWER” parameters: Drawbar levels will be shown numerically.
“DB Preset’s Perc” parameter: The program name will be displayed.
“EX Drawbar Type” parameter: The EX Drawbar settings will be shown numerically.
- Group 3: The program name will be displayed.
- Group 4: The program name will be displayed.
- Group 5: The program name will be displayed.
- Group 6: The program name will be displayed.
- Group 7 “Mod Wheel” and “Mod Wheel Range” parameters: The program name will be displayed.
Other parameters: The assigned controller will be displayed. If more than one controller is assigned, they will be displayed in succession each time you press the [DISPLAY] key.
- Group 8: The program name will be displayed.

Global mode

The following information is displayed when you press the [DISPLAY] key.

- Groups 1–3, 6, 8: The display will not change when you press the [DISPLAY] key.
- Groups 4, 5: The selected CC# and controller name will be displayed. If the CC# had been blinking before you pressed the [DISPLAY] key, this means that another controller has already been assigned to that number. If you press the [DISPLAY] key while this is blinking, the assigned controller name will be displayed each time you press the key.
- Group 7 “Program Mapper” parameter: The program number and program name corresponding to the currently-shown MIDI program number will be displayed. If the MIDI program number had been blinking before you pressed the [DISPLAY] key, this means that a program has already been assigned to that number. If you press the [DISPLAY] key while this is blinking, the assigned program name will be displayed each time you press the key.
“Copy, Swap, Init” parameters: If you press the [DISPLAY] key when the Speaker icon is displayed, the name of the program marked by the icon will be displayed.
“MIDI Dump” parameter: If you press the [DISPLAY] key when dumping one program, the name of the program being dumped will be displayed.
Other parameters: The display will not change.

2. About the programs

The BX-3 contains **128 preset programs** (64 for Normal mode, and 64 for EX mode).

In both Normal mode and EX mode, the programs are organized into banks A–H, with eight programs in each bank.

How a program is structured

A preset program consists of the following four types of setting.

- 1) Organ sound settings (tone wheel selection, etc.)
- 2) Drawbar parameter settings
- 3) Effect settings
- 4) Front panel key settings

Each program contains its own settings. When you switch programs, the parameter settings of the selected program will be used.

The **drawbar parameter settings** saved within each program are used if [DRAWBAR PRESET] is selected in the front panel DRAWBAR SELECT section. If you have selected either [DRAWBAR 1] or [DRAWBAR 2] in the DRAWBAR SECTION, the front panel Drawbar 1 or Drawbar 2 settings will be used.

The **front panel key settings** saved within each program are used if the Global mode Group 1 “Prg.Chng” parameter is set to **All Params**. If the “Prg.Chng” parameter is set to **Int. Params**, the state of the front panel keys will be used, meaning that the state of the front panel keys will not change when you switch programs.

3. Restoring the factory settings

The BX-3 lets you re-initialize either the programs or the Global parameters back to their original factory settings. Use this procedure if you have accidentally overwritten a preset program, or want to return to the original factory settings.

Initialization can be performed on the following four types of data:

- One program
- All programs
- Global parameters
- All program parameters and Global parameters

 Restoring the factory settings will erase any edits or changes you may have made to the data.

Initializing one program

1. Press the [GLOBAL] key to enter Global mode.
2. Press the PROGRAM [7] key and then press the [▶] key once.

The display will indicate Copy Swap Init.



3. Press the [WRITE/ENTER] key.
“Copy” will blink in the display.



4. Press the [+] key twice.
“Init Program” will appear in the left of the display, and “Program” will blink.
5. Press the [▶] key once.
A speaker icon will appear at the left of the program number.
You can play the keyboard to audition the sound of the program.
6. Use the [-] or [+] keys to select the program that you want to initialize.
7. Press the [WRITE/ENTER] key.
A message will ask you whether you want to initialize the program.
To cancel the procedure, press the [EXIT] key.
8. Press the [WRITE/ENTER] key once again.
When initialization has been completed, the display will indicate **Init Completed**, and you will return to step 4.
9. Press the [EXIT] key twice to return to the previous mode.

Initializing all programs

Steps 1–3 are the same as for “Initializing one program,” above.

4. Press the [+] key three times.
“Init All Program” will appear in the left of the display, and “All Program” will blink.

5. Press the [WRITE/ENTER] key.

A message will ask you whether you want to initialize all the programs.

To cancel the procedure, press the [EXIT] key.

6. Press the [WRITE/ENTER] key once again.

When initialization has been completed, the display will indicate **Init Completed**, and you will return to step 4.

7. Press the [EXIT] key twice to return to the previous mode.

Initializing the Global parameters

Steps 1–3 are the same as for “Initializing one program,” above.

4. Press the [+] key four times.

“Init Global” will appear in the left of the display, and “Global” will blink.

5. Press the [WRITE/ENTER] key.

A message will ask you whether you want to initialize the Global parameters.

To cancel the procedure, press the [EXIT] key.

6. Press the [WRITE/ENTER] key once again.

When initialization has been completed, the display will indicate **Init Completed**, and you will return to step 4.

7. Press the [EXIT] key twice to return to the previous mode.

Initializing programs and Global parameters

Steps 1–3 are the same as for “Initializing one program,” above.

4. Press the [+] key five times.

“Init All Data” will appear in the left of the display, and “All Data” will blink.

5. Press the [WRITE/ENTER] key.

A message will ask you whether you want to initialize Program data and Global data.

To cancel the procedure, press the [EXIT] key.

6. Press the [WRITE/ENTER] key once again.

When initialization has been completed, the display will indicate **Init Completed**, and you will return to step 4.

7. Press the [EXIT] key twice to return to the previous mode.

4. Percussion

When playing the upper keyboard, you can use the front panel PERCUSSION keys and drawbars to add percussion.

Percussion adds an attack to the beginning of the note, making the sound more crisp. However when you play legato, percussion will apply only to the first-played note.

Normal mode

1. In the upper DRAWBAR SELECT section, press the [DRAWBAR 2] key or [PRESET DRAWBAR] key.

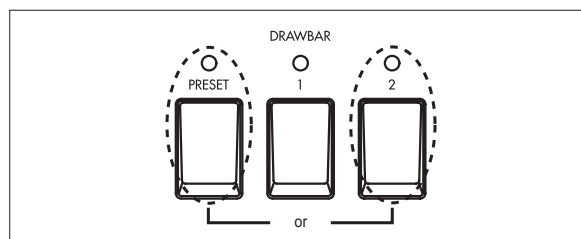

2. In the PERCUSSION section, press the [ON] key. The key LED will light.

3. Press the [FAST] key.

When the key LED is lit, the percussion will decay more quickly. When the key LED is dark, the percussion will decay more slowly.

4. Press the [SOFT] key.

The volume of the percussion will decrease when the key LED is lit, and will return to normal when the key LED goes dark.

The changes that occur when you press the keys of the PERCUSSION section can be specified in Normal Edit mode Group 3, and stored independently for each program.

For these parameters, you can specify the following.

- The volume for Soft and Normal settings
- The decay speed for Fast and Slow settings

If percussion is not added when you operate the keys of the PERCUSSION section, make sure that the [PRESET DRAWBAR] key is selected. If percussion is still not added, use the following procedure to check the “DB Preset’s Perc” parameter.

Checking the “DB Preset’s Perc” parameter

1. Make sure that the display shows the name of a Normal program.

If the display does not show the program name, press the [DISPLAY] key several times.

2. Press the [DISPLAY] key once, and check whether the Percussion icon is shown at the left of UPPER in the display.



If the Percussion icon is displayed, operate the keys of the PERCUSSION section while you play the upper keyboard.

If the Percussion icon is not displayed, proceed to step 3.

Since the “DB Preset's Perc” parameter is set independently for each program, you will have to check each program to see whether percussion can be used for that program.

3. **Press the [EDIT] key.**
You will enter Normal Edit mode.
4. **Press the PROGRAM [2] key, and then press the [▶] key twice.**
The “DB Preset's Perc” parameter will appear.
5. **Press the [-] key once to change the setting to Ena (Enable).**
6. **Press the [EXIT] key to return to Normal mode.**
7. **Now you can assign the PERCUSSION section to the upper keyboard.**

EX mode

Regardless of the settings of the DRAWBAR SELECT section, you can also use the front panel PERCUSSION SECTION keys to add percussion to the upper keyboard.

1. **In the PERCUSSION section, press the [ON] key.**
The key LED will light. The PERCUSSION effect is now on.
2. **Press the [FAST] key.**
When the key LED is lit, the percussion will decay more quickly. When the key LED is dark, the percussion will decay more slowly.
3. **Press the [SOFT] key.**
The volume of the percussion will decrease when the key LED is lit, and will return to normal when the key LED goes dark.
The values for these percussion controls can be accessed in EX Edit mode Group 3, and may be stored independently for each program.
For these parameters, you can specify the following.
 - The volume for Soft and Normal settings
 - The decay speed for Fast and Slow settings

EX Percussion in Drawbar 2

If the upper DRAWBAR SELECT section [DRAWBAR 2] key is selected, the percussion can be adjusted by the front panel Drawbar 2 bars as well as by the front panel PERCUSSION section keys.

EX Percussion (the five right bars of Drawbar 2) controls the percussion levels assigned to these bars. For details, refer to “Using the Drawbar 1 and 2 settings” (p.13).

- 2-2/3': 2-2/3' or 4' (depending on the setting of the PERCUSSION section [3rd] key)
- 2': 16'
- 1-3/5': 5-1/3'
- 1-1/3': The footage assigned to EX Drawbar 16'
- 1': The footage assigned to EX Drawbar 5-1/3'

5. Rotary

The ROTARY Speaker section replicates the sound of the classic rotating drum and horn speaker system associated with the tone wheel organ. Controls are available to simulate different amplification and microphone placement.

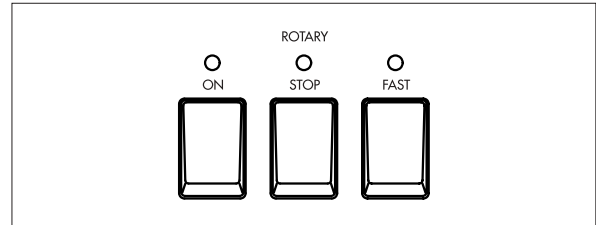

1. **In the front panel ROTARY section, press the [ON] key.**

The key LED will light.

If when you press the ROTARY section [ON] key, the LED blinks three times and then goes dark, the program's “Amp Type” parameter (Group 4 of Normal Edit mode or EX Edit mode) has been set to Pre Amp. With this setting, the rotary speaker effect cannot be obtained. Either select another program, or change the setting of the “Amp Type” parameter.

tips Even if the “Amp Type” parameter is set to Pre Amp, you can select the ROTARY section [STOP] key and [FAST] key. We recommend that you use the [STOP] key and [FAST] key to pre-select the settings you want for the next time you select a Type 1 or Type 2 program.

2. **Use the [FAST] key and [STOP] key to control the rotation of the rotary speaker.**

To switch between fast and slow, make the [STOP] key LED go dark, and operate the [FAST] key.

When you press the [FAST] key to make the LED light, the rotary speaker will turn rapidly. When you make the LED go dark, the rotary speaker will turn slowly.

To switch between fast and stopped, make the [STOP] key LED light, and operate the [FAST] key.

When you press the [FAST] key to make the LED light, the rotary speaker will turn rapidly. When you make the LED go dark, the rotary speaker will stop turning.

To switch between slow and stopped, make the [FAST] key LED go dark, and operate the [STOP] key.

When you press the [STOP] key to make the LED light, the rotary speaker will stop turning. When you make the LED go dark, the rotary speaker will turn slowly.

Rotary speaker settings are made in Group 6 of Normal Edit mode or EX Edit mode, and are saved as part of each program.

The following rotary speaker parameters can be adjusted.

- Volume balance between the horn and rotor of the rotary speaker
- Slow and fast rotational speeds of the horn and rotor
- Transition time from slow to fast, and from fast to slow, for the horn and rotor
- Time from when the rotation of the horn and rotor is stopped until it actually comes to a stop, and the time from when rotation is started until it reaches the specified speed
- The distances from the horn and rotor to the mic
- The spread of the sound from the horn and rotor

6. Effects

Reverb

You can use the front panel [REVERB OFFSET] knob to adjust the depth of reverb.

1. While you play, turn the [REVERB OFFSET] knob.

When the knob is in the center position, the reverb depth will be as specified by the program.

Reverb settings are made in Group 5 of Normal Edit mode and EX Edit mode, and are saved as part of each program.

The following reverb parameters can be adjusted.

- Reverb type
- Reverb time
- Reverb amount
- Reverb routing

Vibrato and chorus

You can use the front panel VIBRATO/CHORUS section to apply vibrato or chorus to the sound.

1. While you play, use the VIBRATO/CHORUS section [UPPER] key or [LOWER] key to select the keyboard(s) to which the effect will be applied.

2. Use the [VIBRATO/CHORUS] knob to select vibrato or chorus.

V1–V3 are vibrato, and C1–C3 are chorus. Higher numbers will produce a greater effect.

Overdrive

You can use the front panel [EXPRESSION/OVERDRIVE] knob to adjust the amount of overdrive. This will also affect the volume.

1. While you play, turn the [EXPRESSION/OVERDRIVE] knob.

This will adjust the output level of the tone generator, changing the input level of the internal amp simulation.

By using this in conjunction with the “Amp Gain” parameter (p.26) in Group 4 of Normal Edit mode or EX Edit mode, you can make further adjustments to the overdrive effect.

7. Saving your data

Program parameter settings and Global parameter settings of the BX-3 can be saved by **writing a program** or **transmitting a MIDI data dump**.

Writing to internal memory

Writing a program

A program that you created by editing the parameters in either of the Edit modes can be saved in internal memory. This is referred to as “writing a program.” If you want the program you edited to be preserved even when the power is turned off, you must write it into memory.

When you select a program, the program data is called into an internal **edit buffer**.

When you edit program parameters in Normal Edit mode or EX Edit mode, you are making changes to the data in the edit buffer. When you make changes to this data, an “*” will appear between the program number and program name.

Since your editing will only affect the data in the edit buffer, **you must write this data** into internal memory if you want to keep it.

 If you select another program before writing the edited program, new data will be called into the edit buffer, and your changes will be lost. The data in the edit buffer will also be lost when you turn off the power. If this occurs, the data prior to your editing will be recalled the next time the power is turned on.

Writing procedure

1. Make sure that you are in Normal mode or EX mode, and that the Enter icon is not displayed. Then press the [WRITE/ENTER] key.

The left side of the display will indicate “WRITE.” The writing-destination program number will be displayed in the square brackets [] at the right.

2. If you want to change the writing destination, use the [-] [+] keys to specify the desired destination.

By playing the keyboard, you can audition the sound of the program marked by the **Speaker icon** in the display. You can use the [√] [▶] keys to move the Speaker icon, so that you can audition the writing-source and writing-destination programs.

tips When the Speaker icon is displayed, you can press and hold the [DISPLAY] key to view the name of the program indicated by the icon.

tips At this time, you can press the [GLOBAL] key to switch to writing the Global parameters. To return to writing the program, press the [EDIT] key.

3. Press the [WRITE/ENTER] key.

A message will ask whether it is OK to write the program.

If you decide to cancel, press the [EXIT] key.

4. Press the [WRITE/ENTER] key.

When the data has been written, the display will indicate **Write Completed**.

Writing the Global parameters

Settings that affect all programs in common, such as MIDI settings, are made in Global mode.

When you turn on the power, the Global mode data will be called into the internal Global mode **memory area**.

When you edit a parameter in Global mode, the data in this memory area will change.

If you want the edited data to be saved in internal memory, **you must write it**.

 If you turn off the power before writing the Global parameters, the edited data in the memory area will be lost. If this occurs, the data prior to your editing will be recalled the next time the power is turned on.

Writing procedure

- 1. Make sure that you are in Global mode, and that the Enter icon is not displayed. Then press the [WRITE/ENTER] key.**

The left side of the display will indicate **WRITE GLOBAL**.

tips At this time you can press the [EDIT] key to write program data. To return to the writing the Global parameters, press the [GLOBAL] key.

- 2. Press the [WRITE/ENTER] key.**

A message will ask you whether it is OK to write. If you decide to cancel, press the [EXIT] key.

- 3. Press the [WRITE/ENTER] key.**

When the data has been written, the display will indicate **Write Completed**.

MIDI data dump

The programs and global settings in internal memory can be transmitted as MIDI exclusive data, and saved on a connected external device such as a data filer. For details, refer to "MIDI data dump" (p.37).

8. Editing

You can edit the tone or name of the selected program. When editing a program, it is a good idea to start by selecting the program that is closest to what you have in mind, and make your changes from there.

This section explains some simple ways to edit.

 If you select another program or turn off the power before writing your edited settings, the changes will be lost. For details, refer to "Writing a program" (p.19).

Editing the sound

The BX-3 has several parameters that simulate the sound of the a tone wheel organ, and these can be set independently for each program.

As an example, here's how to edit the parameters of group 1.

- 1. Press the [EDIT] key to enter either Normal Edit mode or EX Edit mode.**

- 2. Press the PROGRAM [1] key, and then press the [▶] key once to access the "Wheel Type" parameter.**

This selects the type of tone wheel.

The **tone wheel** is the mechanism that produces the pitches used to create the sound.

- 3. Use the [-] [+] keys to select the desired setting.**

Vintage includes leakage noise. This is noise caused by signal leakage from the tone wheel, and is a characteristic part of the sound of a tone wheel organ. **Clean** contains no leakage noise.

- 4. Press the [▶] key once to access the "DB LevelCurve" parameter, and use the [-] [+] keys to adjust the setting.**

This adjusts the tone of the drawbars.

Bright produces a brighter sound as you play higher on the keyboard, and **Mellow** produces a more mellow sound in the upper octaves.

- 5. Press the [▶] key once to access the "Over Tone Level" parameter, and use the [-] [+] keys to adjust the setting.**

This parameter adjusts the overtone level of the tone wheel. Higher settings will produce a greater amount of overtones.

- 6. Press the [▶] key once to access the "Leakage Level" parameter, and use the [-] [+] keys to adjust the setting.**

This adjusts the leakage noise. Higher settings will increase the volume of the leakage noise.

- 7. Press the [▶] key once to access the "Noise Level" parameter, and use the [-] [+] keys to adjust the setting.**

This adjusts the noise that will occur regardless of whether notes are being played. Higher settings will increase the volume of the noise.

- 8. Press the [▶] key once to access the "On Click Level" parameter, and use the [-] [+] keys to adjust the setting.**

This parameter simulates the noise that occurs when a key is pressed. Here you can adjust the volume of that noise. Higher settings will increase the noise volume.

9. Press the [▶] key once to access the “Off Click Level” parameter, and use the [-] [+] keys to adjust the setting.

This parameter simulates the noise that occurs when a key is released. Here you can adjust the volume of that noise. Higher settings will increase the noise volume.

10. Press the [WRITE/ENTER] key to write the settings into internal memory.

For details, refer to “Writing a program” (p.19).

Other parameters

The BX-3 has other parameters that apply various effects to the sound. In the factory-set programs, these effects are set as appropriate for each sound.

If you want to make detailed adjustments to the sound of a program, you can edit the following parameters in Normal Edit mode or EX Edit mode.

- Percussion settings: Group 3 (p.25)
- Amp simulator settings: Group 4 (p.26)
- Reverb settings: Group 5 (p.26)
- Rotary speaker settings: Group 6 (p.26)
- Modulation wheel and pedal controller settings: Group 7 (p.27)

Editing the drawbar parameters

When the DRAWBAR SELECT section [DRAWBAR PRESET] key is pressed, the drawbars will sound at the levels saved with the current program. These settings are saved individually for each program.

Normal mode

If the [DRAWBAR PRESET] key is pressed in both upper and lower DRAWBAR SELECT sections, the “UPPER” parameters will be used when you play the upper keyboard, and the “LOWER” parameters will be used when you play the lower keyboard.

If you want to edit these settings, use the following procedure.

1. Select a program in Normal mode.

2. Press the [EDIT] key.

You will enter Normal Edit mode.

3. Press the PROGRAM [2] key.

The left side of the display will indicate **UPPER**, and to the right of this the “UPPER” parameter settings will be displayed.



If you are unable to adjust the “UPPER” parameter settings, make sure that the DRAWBAR SELECT section [DRAWBAR PRESET] key is selected. If the [DRAWBAR PRESET] key is not selected, its LED will begin to blink.

4. Move the bars of the Drawbar 1 or Drawbar 2 sections (you may use either) to adjust the drawbar parameters.

Any bar you move will input a new value for that parameter, and the display will change accordingly.

5. Press the [▶] key once to display the “LOWER” parameters.

6. Move the bars of the Drawbar 1 or Drawbar 2 sections to adjust the drawbar parameters.

7. Press the [WRITE/ENTER] key to write the settings into internal memory.

For details, refer to “Writing a program” (p.19).

EX mode

In EX mode, the lower keyboard will play the “EX LOWER” parameter settings that are preset in the program, regardless of the current setting in the DRAWBAR SELECT section.

To edit these settings, use the following procedure.

1. Select a program in EX mode.

2. Press the [EDIT] key.

You will enter EX Edit mode.

3. Press the PROGRAM [2] key, and then press the [▶] key once.

The “EX LOWER” parameters will be displayed.

4. Use the [√][▶] keys to select a bar.

You can make settings for the three bars 16', 8', and 4'.



5. Use the [-][+] keys to adjust the value.

The display will show the value as you adjust it.

6. Press the [WRITE/ENTER] key to write the settings into internal memory. For details, refer to “Writing a program” (p.19).

Copying drawbar parameters

The front panel Drawbar 1 or Drawbar 2 settings can be copied directly to the “UPPER” or “LOWER” parameters of a Normal program, or to the “EX Drawbar Level” parameters of an EX program.

As an example, here's how you can select a Normal program, use the front panel Drawbar 1 bars to create a sound, and then copy the settings to the “UPPER” parameters of the program.

1. Select a program in Normal mode.

2. In the upper DRAWBAR SELECT section, press the [DRAWBAR 1] key.

3. While playing the keyboard, use the front panel Drawbar 1 bars to create the desired sound.

- In the upper DRAWBAR SELECT section, hold down the [DRAWBAR 1] key and press the [DRAWBAR PRESET] key.

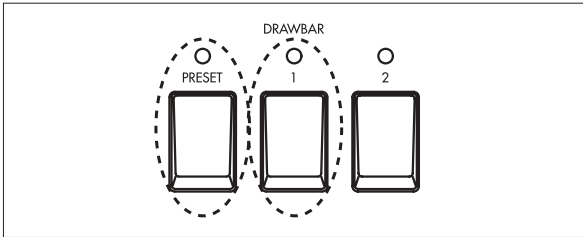

The Drawbar 1 settings will be copied to the “UPPER” parameters, and an “*” will appear between the program number and program name.



- Press the [WRITE/ENTER] key to write the settings into internal memory.

For details, refer to “Writing a program” (p.19).

tips The upper DRAWBAR SELECT section can be used to copy drawbar parameters in EX mode as well. Create the sound in the upper keyboard, then hold down the upper [DRAWBAR 1] or [DRAWBAR 2] key, and press the [DRAWBAR PRESET] key.

Copying a program

This is convenient when you want to create several variations of a program by making small changes to the parameter settings.

- Press the [GLOBAL] key to enter the Global mode.
- Press the PROGRAM [7] key, and then press the [▶] key once.
The display will indicate Copy Swap Init.
- Press the [WRITE/ENTER] key.
In the display, “Copy” will blink, and the copy source and copy destination program numbers will appear at the right.



- Press the [▶] key once, and the Speaker icon will appear at the left of the copy-source program number.
You can play the keyboard to hear the sound of the program.



- To change the copy-source, use the [-][+] keys to specify the source program number.
- To change the copy-destination, press the [▶] key once, and then use the [-][+] keys to specify the destination program number.

The Speaker icon will appear at the left of the copy-destination program number.



- Press the [WRITE/ENTER] key.
A message will ask you to confirm the copy. If you decide to cancel, press the [EXIT] key.
- Press the [WRITE/ENTER] key once again.
When the program has been copied, the display will indicate Copy Completed.

Swapping two programs

This operation exchanges two programs. This is convenient when you want to rearrange the order of the programs.

- Press the [GLOBAL] key to enter the Global mode.
- Press the PROGRAM [7] key, and then press the [▶] key once.
The display will indicate Copy Swap Init.
- Press the [WRITE/ENTER] key, and then press the [+] key once.
“Swap” will blink in the display. The swap-source and swap-destination program numbers will be displayed at the right.
- Press the [▶] key once, and the Speaker icon will appear at the left of the swap-source program.
You can play the keyboard to hear the sound of the program.
- If you want to change the swap source, use the [-][+] keys to specify the source program number.
- If you want to change the swap destination, press the [▶] key once, and then use the [-][+] keys to specify the destination program number.
- Press the [WRITE/ENTER] key.
A message will ask you to confirm the swap. If you decide to cancel, press the [EXIT] key.
- Press the [WRITE/ENTER] key once again.
When the swap is completed, the display will indicate Swap Completed.

Editing the name of a program

- Press the [EDIT] key to enter Normal Edit mode or EX Edit mode.
- Press the PROGRAM [8] key.
“Rename” will appear in the left of the display, and the program name will be displayed in square brackets [].
- Use the [✓] [▶] keys to select the character that you want to change.

4. Use the [-][+] keys to specify the desired character.

You can assign a program name of up to 12 characters.

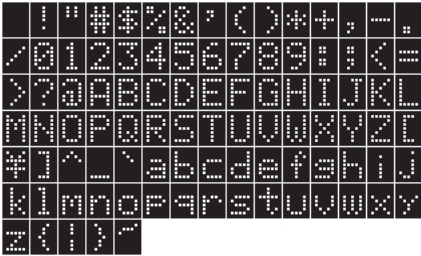

5. Press the [WRITE/ENTER] key to write the settings into internal memory.

For details, refer to "Writing a program" (p.19).

Parameters

1. Normal Edit mode / EX Edit mode

In Normal Edit mode or EX Edit mode, you use the PROGRAM [1]–[8] keys to directly select the first parameter in each of the parameter edit Groups 1 - 8.

Group 1: Basic Character

Specifies the output level, tone wheel noise, click level etc.

Group 2: Drawbar

Specifies the drawbar levels and EX drawbar type.

tips The parameters that are displayed will differ between Normal Edit mode and EX Edit mode.

Group 3: Percussion

Specifies how the BX-3 will respond to the PERCUSSION section controls.

Group 4: Amp

Specifies amp settings.

Group 5: Reverb

Adjusts reverb settings.

Group 6: Rotary effect

Specifies rotary speaker settings.

Group 7: Controller

Specifies settings for the modulation wheel, and specify the functions of the ASSIGNABLE PEDAL/SW jacks.

Group 8: Program Name

Edits the program name.

Group 1: Basic Character

Output Level [0...127]

Sets the output level of the program.

Wheel Type [Vintage, Clean]

Selects the type of tone wheel.

Vintage: A tone wheel that includes leakage noise.

Clean: A tone wheel that does not include leakage noise.

DB LevelCurve [Bright, Mellow]

Selects the tone.

The tone will change as the volume balance of the drawbars is adjusted.

Bright: A bright tone.

Mellow: A mellow tone.

Over Tone Level [0...99]

Specifies the overtone level of the tone wheel.

Leakage Level [0...99]

Specifies the level of the leakage noise.

Noise Level [0...99]

Specifies the amount of noise that will occur regardless of whether notes are played. This noise will include leakage noise, and its amount will depend on the level specified by the "Leakage Level" parameter.

On Click Level [0...99]

Specifies the level of the click noise at key-on.

Off Click Level [0...99]

Specifies the level of the click noise at key-off.

Group 2: Drawbar

UPPER (Upper Drawbar Level) [0...8]

This is displayed in Normal Edit mode.



Specifies the volume of the footage used when you play the upper keyboard in Normal mode.

To change these settings, press the [DRAWBAR PRESET] key of the upper DRAWBAR SELECT section in Normal mode. When you move the Drawbar 1 or 2 bars of the front panel, the volume of the corresponding footage will change. If you pull a bar out all the way, its level will be 8.

tips In Normal mode when the program name is displayed, pressing the [DISPLAY] key once will let you view these settings in the display.

LOWER (Lower Drawbar Level) [0...8]

This is displayed in Normal Edit mode. Here you can specify the volume of the footage used when you play the lower keyboard in Normal mode. To change these settings, press the [DRAWBAR PRESET] key of the lower DRAWBAR SELECT section in Normal mode. When you move the Drawbar 1 or 2 bars of the front panel, the volume of the corresponding footage will change. If you pull a bar out all the way, its level will be 8.

tips In Normal mode when the program name is displayed, pressing the [DISPLAY] key once will let you view these settings in the display.

DB Preset's Perc (Drawbar Preset Percussion) [Dis, Ena]

This is displayed in Normal Edit mode. This setting specifies whether the keys of the PERCUSSION section can be used when you play the upper keyboard in Normal mode.

Dis (Disable): Operating the PERCUSSION section keys will have no effect.

Ena (Enable): The PERCUSSION section keys will have their usual effect.

tips In Normal mode when the program name is displayed, pressing the [DISPLAY] key once will let you view these settings in the display. If this setting is set to Ena (enable), the Percussion icon will appear at the left of the UPPER display.

EX DRAWBAR & PERCUSSION [0...8]

This is displayed in EX Edit mode.



EX Drawbar and EX Percussion of Drawbar 2

Here you can specify the footage and percussion volume used when you play the upper keyboard in EX Edit mode.

To edit the values, press the [DRAWBAR PRESET] key in the upper DRAWBAR SELECT section while in EX Edit mode. When you move the front panel Drawbar 1 or 2 bars, the corresponding footage or percussion volume will change. The value will be 8 when a bar is pulled all the way out.

For details on what is assigned to each bar, refer to "Using the Drawbar 1 and 2 settings" (p.13).

tips In EX mode, pressing the [DISPLAY] key once while the program name is displayed will display the current Drawbar 1 and EX Drawbar (Drawbar 2) values. If you then press the [DISPLAY] key once again, the EX Percussion (Drawbar 2) values will be displayed.

EX LOWER (EX Lower Level) [0...8]

This is displayed in EX Edit mode. These settings specify the footage volumes used when you play the lower keyboard in EX mode. You can make settings for the three drawbars 16', 8', and 4'. For details on how to make these settings, refer to "EX mode" (p.21).

Ex Drawbar Type [1...4]

This is displayed in the EX Edit mode. By selecting the type, you can specify the pitches that are assigned to the EX Drawbars (Encoder 2). The pitches for each of these types are specified by the Global mode Group 6 "Ex Drawbar Type 1-1" through "Ex Drawbar Type 4-4" parameters.

Group 3: Percussion**Perc Nrml Level (Percussion Normal Level) [0...99]**

This sets the volume of the percussion when the [SOFT] key of the PERCUSSION section is at the normal setting (key LED dark).

Perc Soft Offset (Percussion Soft Level Offset) [0...99]

This sets the volume of the percussion when the [SOFT] key of the PERCUSSION section is at the soft setting (key LED lit). This setting determines how much the volume will be lowered from the value specified by the "Perc Nrml Level" parameter.

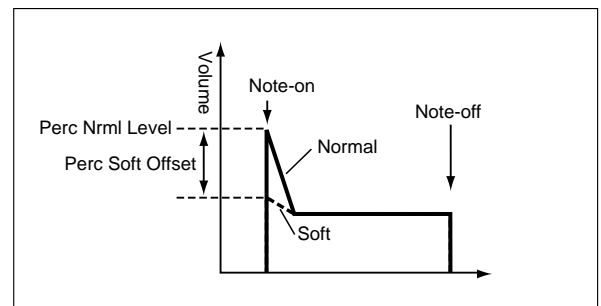
**Normal Perc DB ATT (Normal Percussion Drawbar Attenuation) [0...99]**

This decreases the level of the sound created by the Drawbar 2 bars or the "UPPER" parameters when the percussion is set to normal (the [SOFT] key is dark). This allows the percussion effect to become more pronounced, without increasing the overall volume.

Perc Fast Decay (Percussion Fast Decay) [0...99]

This sets the decay speed when the [FAST] key of the PERCUSSION section is at the fast setting (key LED lit).

Perc Slow Offset (Percussion Slow Offset) [0...99]

This sets the decay speed when the [FAST] key of the PERCUSSION section is at the slow setting (key LED dark). This setting will determine how much the speed is slowed from the value specified by the "Perc Fast Decay" parameter.

.....
Group 4: Amp

Amp Type [Type 1, Type 2, Pre Amp]

here you can select the amp type.

Type 1: This is a conventional organ power amp. It produces a mild and fat sound.

Type 2: Compared to Type 1, this emphasizes the high range, and produces a more uncolored sound.

Pre Amp: Use a pre amp. This is the sound of the organ's line-out.

tips When Type 1 or Type 2 are selected: When the front panel ROTARY [ON] key is used to turn on the rotary speaker, the effect of the rotary speaker will be simulated. When this is turned off, a conventional speaker will be simulated.

When Pre Amp is selected: The power amp and rotary speaker will not be used, and the sound will be as if it were taken from the preamp line-out of the organ itself.

Spkr Simulator (Speaker Simulator) [On, Off]

When the "Amp Type" parameter is set to Type 1 or Type 2, this turns the amp simulator function on or off.

Amp Gain [0...99]

Adjusts the gain (amplification) when the "Amp Type" parameter is set to Type 1 or Type 2.

With high settings of this value, the sound will distort more severely when the expression/overdrive is raised.

tip This setting will not apply if the "Amp Type" parameter is set to Pre Amp.

Tone Trebel [-10...+10]

Adjusts the high frequency level of the amp selected by the "Amp Type" parameter.

Tone Middle [-10...+10]

Adjusts the mid-frequency level of the amp selected by the "Amp Type" parameter.

Tone Bass [-10...+10]

Adjusts the low frequency level of the amp selected by the "Amp Type" parameter.

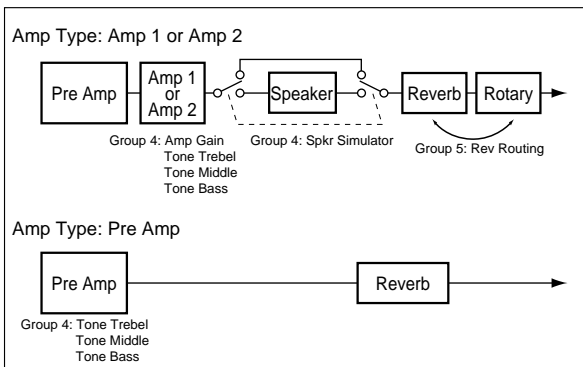

.....
Group 5: Reverb

Reverb Type [Room, Hall, Plate, Dark]

Selects the type of reverb.

Reverb Time [00.25...16.00 (Sec)]

Specifies the reverb time.

tip The range in which the reverb time can be adjusted will depend on your selection for the "Reverb Type" parameter.

Reverb Mix Level [0...99]

Specifies the amount of reverb signal that is mixed with the original sound.

Rev Routing (Reverb Routing) [Rot->Rev, Rev->Rot]

Selects whether the reverb will be applied before the rotary speaker or after it.

Rot->Rev: Reverb will be applied after the rotary speaker.

Rev->Rot: Reverb will be applied before the rotary speaker.

tip This setting will not be used if the "Amp Type" parameter is set to Pre Amp.

.....
Group 6: Rotary Effect

tip These settings will not be used if the "Amp Type" parameter is set to Pre Amp.

Horn: 0 Rotor: 100 (Rotary Horn/Rotor Balance) [0:100...100:0]

Adjusts the volume balance between the horn and rotor of the rotary speaker.

Horn Slow Speed [0...99]

Specifies the rotational speed of the horn during slow rotation.

Horn Fast Speed [0...99]

Specifies the rotational speed of the horn during fast rotation.

Rotor Slow Speed [0...99]

Specifies the rotational speed of the rotor during slow rotation.

Rotor Fast Speed [0...99]

Specifies the rotational speed of the rotor during fast rotation.

Horn Up Transit (Horn Up Transition) [0...99]

Specifies the time over which the horn will change from slow to fast rotation.

Horn Down Transit (Horn Down Transition) [0...99]

Specifies the time over which the horn will change from fast to slow rotation.

Horn Stop Transit (Horn Stop Transition) [0...99]

Specifies the time it will take for the horn to actually come to rest after rotation is switched off.

Horn Strt Transit (Horn Start Transition) [0...99]

Specifies the time it will take for the horn to reach the specified speed after rotation is switched on.

Rotor Up Transit (Rotor Up Transition) [0...99]

Adjusts the time over which the rotor rotation changes from slow to fast.

Rotor Down Transit (Rotor Down Transition) [0...99]

Adjusts the time over which the rotor rotation changes from fast to slow.

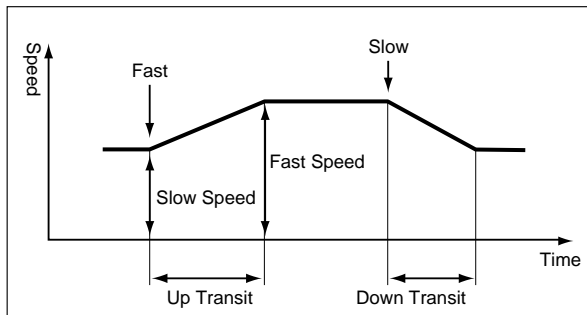

Rotor Stop Transit (Rotor Stop Transition) [0...99]

Adjusts the time over which the rotor rotation actually comes to a stop after you stop the rotation.

Rotor Strt Transit (Rotor Start Transition) [0...99]

Adjusts the time over which the rotor reaches the specified speed after it begins to rotate.

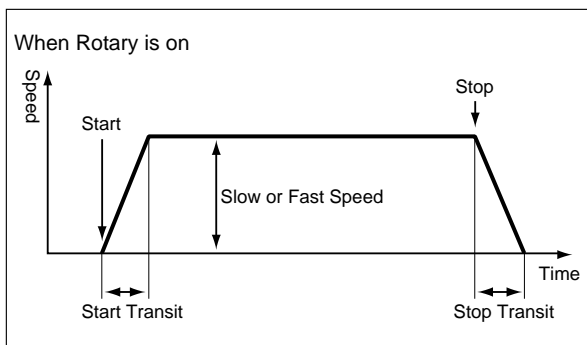

Horn Mic Distance [0...99]

Adjusts the distance between the horn and the mic.

Horn Mic Spread [0...99]

Adjusts the distance between the "simulated mics" to increase the stereo field.

Rotor Mic Distance [0...99]

Adjusts the distance between the rotor and the mic.

Rotor Mic Spread [0...99]

Adjusts the distance between the "simulated mics" to increase the stereo field.

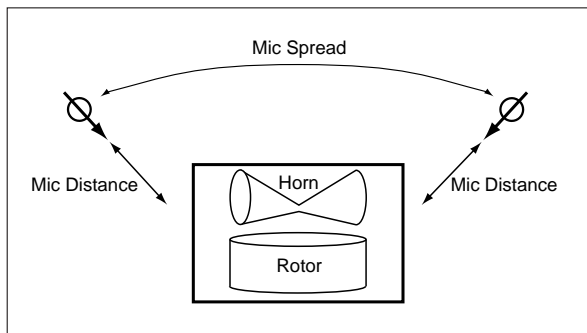

.....
Group 7: Controller

Mod Wheel (Modulation Wheel)

[No Assign...ExLowLevl]

Select the parameter that will be controlled by the front panel modulation wheel.

If this is set to other than No Assign, Rtry FAST, or Wheel Brake, the result of moving the wheel will depend on the setting of the "Mod Wheel Range."

No Assign: Nothing will be controlled.

Click Level: Control the "On Click Level" and "Off Click Level" parameters (Group 1).

Perc Level (Percussion Level): Control the "Perc Nrml Level" parameter (Group 3).

Perc Decay (Percussion Decay): Control the "Perc Fast Decay" parameter (Group 3).

Rtry FAST (Rotary Fast/Slow): Control the front panel ROTARY [FAST] key. The modulation wheel will function as a switch, and will select Fast when the wheel is moved toward yourself, and Slow when moved away from yourself.

Rtry Speed (Rotary Speed): Control the "Horn Fast Speed," "Horn Slow Speed," "Rotary Fast Speed," and "Rotary Slow Speed" parameters (Group 6).

Wheel Brake: Control the "Wheel Brake" parameter (Global mode Group 7). The modulation wheel will function as a switch, and will turn on the wheel brake effect when the modulation wheel is moved away from yourself, and will turn off the wheel brake effect when moved toward yourself.

ExLowrLevl (EX Lower Level): Control the "EX LOWER" parameter (Group 2).

Mod Wheel Range (Modulation Wheel Range)

[-99...+99]

When the "Mod Wheel" parameter is set to other than No Assign, Rtry FAST, or Wheel Brake, the range of the effect controlled by operating the modulation wheel can be adjusted from a maximum of 0 to a maximum of 99.

When you move the modulation wheel fully toward yourself, the parameter being controlled will be at its own original setting.

When you move the modulation wheel fully away from yourself, the value you specify here will be added to the original value of the parameter being controlled. However, the total value is limited to a range of 0 to 99.

If the "Perc Nrml Level" parameter is set to 50, the following Mod Wheel Range settings will allow the position of the modulation wheel to change the percussion level as follows.

+20: The percussion level will be 50 when the modulation wheel is fully toward yourself, and 70 when fully away from yourself.

-20: The percussion level will be 50 when the modulation wheel is fully toward yourself, and 30 when fully away from yourself.

If the "Perc Nrml Level" parameter is set to 99, the following Mod Wheel Range settings will allow the position of the modulation wheel to change the percussion level as follows.

+99: The percussion level will be 99 when the modulation wheel is fully toward yourself, and 99 when fully away from yourself (since the controllable range is 0-99).

-99: The percussion level will be 99 when the modulation wheel is fully toward yourself, and 0 when fully away from yourself.

Hold Uppr Ctrl (Hold Upper Controller)**[Off, Pedal 1/(Pdl1)*, Pedal 2/(Pdl 2)*]**

This is displayed in Normal Edit mode.

Pedal 1: A pedal switch etc. connected to the rear panel ASSIGNABLE PEDAL/SW 1 jack will switch Hold on/off for the notes played on the keyboard that controls the UPPER tone generator.**Pedal 2:** A pedal switch etc. connected to the rear panel ASSIGNABLE PEDAL/SW 2 jack will perform the above operation.**Off:** No function.**Hold Lowr Ctrl (Hold Lower Controller)****[Off, Pedal 1/(Pdl1)*, Pedal 2/(Pdl 2)*]**

This is displayed in Normal Edit mode.

Pedal 1: A pedal switch etc. connected to the rear panel ASSIGNABLE PEDAL/SW 1 jack will switch Hold on/off for the notes played on the keyboard that controls the LOWER tone generator.**Pedal 2:** A pedal switch etc. connected to the rear panel ASSIGNABLE PEDAL/SW 2 jack will perform the above operation.**Off:** No function.**Wheel Brk Ctrl (Wheel Brake Controller)****[Off, Pedal 1/(Pdl1)*, Pedal 2/(Pdl 2)*]**

This is displayed in Normal Edit mode.

Pedal 1: A pedal switch etc. connected to the rear panel ASSIGNABLE PEDAL/SW 1 jack will switch the "Wheel Brake" parameter (Global mode Group 7) on/off.**Pedal 2:** A pedal switch etc. connected to the rear panel ASSIGNABLE PEDAL/SW 2 jack will perform the above operation.**Off:** No function.**Wheel Brk Pedal (Wheel Brake Pedal Mode)****[Momnt, Alter]**

Select the on/off operation of the pedal switch etc. connected to the rear panel ASSIGNABLE PEDAL/SW 1 or 2 jack.

Momnt: The pitch will gradually fall as long as you continue pressing the pedal switch. When you release the pedal switch, the pitch will gradually rise to the normal state.**Alter:** The pitch will begin falling once you press the pedal switch. When you press it once again, the pitch will gradually rise to the normal state.**Rtry FAST Ctrl (Rotary FAST Controller)****[Off, Pedal 1/(Pdl1)*, Pedal 2/(Pdl 2)*]****Pedal 1:** A pedal switch etc. connected to the rear panel ASSIGNABLE PEDAL/SW 1 jack will turn the ROTARY [FAST] key on/off.**Pedal 2:** A pedal switch etc. connected to the rear panel ASSIGNABLE PEDAL/SW 2 jack will perform the above operation.**Off:** No function.**Rtry FAST Pedal (Rotary FAST Pedal Mode)****[Momnt, Alter]**

Select the on/off operation of the pedal switch etc. connected to the rear panel ASSIGNABLE PEDAL/SW 1 or 2 jack. The pedal switch will have the same function as pressing the front panel ROTARY [FAST] key.

Momnt: The rotary speed will gradually increase as long as you continue pressing the pedal switch, until it reaches the speed specified by the Group 6 "Rotor Fast Speed" parameter. When you release the pedal switch, the rotary speed will gradually decrease until it reaches the speed specified by the Group 6 "Rotor Slow Speed" parameter.**Alter:** Once you press the pedal switch, the rotary speed will gradually increase until it reaches the speed specified by the Group 6 "Rotor Fast Speed" parameter. When you press the pedal switch once again, the rotary speed will gradually decrease until it reaches the speed specified by the Group 6 "Rotor Slow Speed" parameter.**Rtry STOP Ctrl (Rotary STOP Controller)****[Off, Pedal 1/(Pdl1)*, Pedal 2/(Pdl 2)*]****Pedal 1:** A pedal switch etc. connected to the rear panel ASSIGNABLE PEDAL/SW 1 jack will turn the ROTARY [STOP] key on/off.**Pedal 2:** A pedal switch etc. connected to the rear panel ASSIGNABLE PEDAL/SW 2 jack will perform the above operation.**Off:** No function.**Rtry STOP Pedal (Rotary STOP Pedal Mode)****[Momnt, Alter]**

Select the on/off operation of the pedal switch etc. connected to the rear panel ASSIGNABLE PEDAL/SW 1 or 2 jack. The pedal switch will have the same function as pressing the front panel ROTARY [STOP] key.

Momnt: The rotary speed will gradually slow down and then stop as long as you continue pressing the pedal switch.**Alter:** Once you press the pedal switch, the rotary speed will gradually slow down and then stop.**Amp Gain Ctrl (Amp Gain Controller)****[Off, Pedal 1/(Pdl 1)*, Pedal 2/(Pdl 2)*]****Pedal 1:** An expression pedal etc. connected to the rear panel ASSIGNABLE PEDAL/SW 1 jack will control the Group 4 "Amp Gain" parameter of Normal Edit mode and EX Edit mode.**Pedal 2:** An expression pedal etc. connected to the rear panel ASSIGNABLE PEDAL/SW 2 jack will perform the above operation.**Off:** No function.

* (Pdl 1), (Pdl 2): These indicate that Pedal 1 or Pedal 2 are selected for the Global mode Group 1 "Prog Up Ctrl" or "Prog Down Ctrl" parameters. With these settings, the settings of Global mode are used, and the settings you made here will be ignored. However if you select another value in Global mode, the display here will change from (Pdl 1) to Pedal 1 or from (Pdl 2) to Pedal 2, and you will be able to operate the corresponding function from the pedal switch.

Amp Gain Ctrl Min (Amp Gain Control Minimum)
[0...99]

Specify the minimum setting of the Normal Edit mode and EX Edit mode Group 4 "Amp Gain" parameter. This will be the gain when the expression pedal etc. specified by the "Amp Gain Ctrl" parameter is in the minimum position.

Amp Gain Ctrl Max (Amp Gain Control Maximum)
[0...99]

Specify the maximum setting of the Normal Edit mode and EX Edit mode Group 4 "Amp Gain" parameter. This will be the gain when the expression pedal etc. specified by the "Amp Gain Ctrl" parameter is in the maximum position.

Rev Mix Ctrl (Reverb Mix Controller)
[Off, Pedal 1/(Pdl 1)*, Pedal 2/(Pdl 2)*]

Pedal 1: An expression pedal etc. connected to the rear panel ASSIGNABLE PEDAL/SW 1 jack will control the Group 5 "Reverb Mix Level" parameter of Normal Edit mode and EX Edit mode.

Pedal 2: An expression pedal etc. connected to the rear panel ASSIGNABLE PEDAL/SW 2 jack will perform the above operation.

Off: No function.

Rev Mix Ctrl Min (Reverb Mix Control Minimum)
[0...99]

Specify the minimum setting of the Normal Edit mode and EX Edit mode Group 5 "Reverb Mix" parameter. This will be the reverb mix level when the expression pedal etc. specified by the "Reverb Mix Ctrl" parameter is in the minimum position.

Rev Mix Ctrl Max (Reverb Mix Control Maximum)
[0...99]

Specify the maximum setting of the Normal Edit mode and EX Edit mode Group 5 "Reverb Mix" parameter. This will be the reverb mix level when the expression pedal etc. specified by the "Reverb Mix Ctrl" parameter is in the maximum position.



Group 8: Program Name

Rename

Here you can modify the name. You can use up to twelve characters.

Use the [v] [▶] keys to select the character that you wish to change, and use the [-]/[+] keys to select the character.

The following characters can be used.

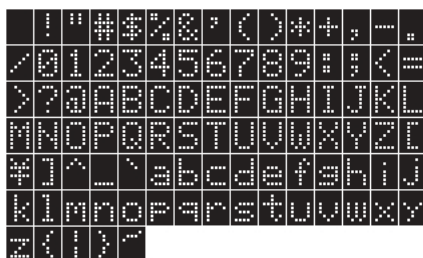

* (Pdl 1), (Pdl 2): These indicate that Pedal 1 or Pedal 2 are selected for the Global mode Group 1 "Prog Up Ctrl" or "Prog Down Ctrl" parameters. With these settings, the settings of Global mode are used, and the settings you made here will be ignored. However if you select another value in Global mode, the display here will change from (Pdl 1) to Pedal 1 or from (Pdl 2) to Pedal 2, and you will be able to operate the corresponding function from the pedal switch.

Prog Up Ctrl (Program Up Controller)
[Off, Pedal 1/(Pdl 1), Pedal 2/(Pdl 2)]

Pedal 1: The pedal switch connected to the rear panel ASSIGNABLE PEDAL /SW 1 jack will switch programs. Each time you operate the pedal switch, the program number will be increased by 1.

Pedal 2: The pedal switch connected to the rear panel ASSIGNABLE PEDAL /SW 2 jack will perform the function described above.

Off: No function

(Pdl 1), (Pdl 2): Indicates that this pedal switch is already selected for the following “Prog Down Ctrl” parameter. Please select a different pedal switch.

 If the same pedal switch is selected for a parameter in Normal Edit mode or EX Edit mode as well as for this Global parameter, this Prog Up Ctrl setting will be used, and the setting in Normal Edit mode or EX Edit mode will be ignored.

Prog Down Ctrl (Program Down Controller)
[Off, Pedal 1/(Pdl 1), Pedal 2/(Pdl 2)]

Pedal 1: The pedal switch connected to the rear panel ASSIGNABLE PEDAL /SW 1 jack will switch programs. Each time you operate the pedal switch, the program number will be decreased by 1.

Pedal 2: The pedal switch connected to the rear panel ASSIGNABLE PEDAL /SW 2 jack will perform the function described above.

Off: No function

(Pdl 1), (Pdl 2): Indicates that this pedal switch is already selected for the above “Prog Up Ctrl” parameter. Please select a different pedal switch.

 If the same pedal switch is selected for a parameter in Normal Edit mode or EX Edit mode as well as for this Global parameter, this Prog Down Ctrl setting will be used, and the setting in Normal Edit mode or EX Edit mode will be ignored.

Pedal 1 Sw Polarity (Pedal 1 Switch Polarity) [-, +]
Pedal 2 Sw Polarity (Pedal 2 Switch Polarity) [-, +]

Set these parameters to match the polarity of the pedal switches connected to the rear panel ASSIGNABLE PEDAL /SW 1 and 2 jacks. If these settings do not match the actual polarity of the pedal switches, the pedal switches will not operate correctly. For example, the separately sold PS-1 pedal switch has a “-” (↓) polarity, so you would set this parameter to “-” when connecting this pedal switch.

.....
Group 2: MIDI Channel

MIDI Global ch (MIDI Global Ch) [1...16]

Specifies the global MIDI channel that will be used to transmit and receive MIDI. (The factory setting is 1.)

MIDI Upper Rx ch (MIDI Upper Receive Channel)
[1...16, Off]

Specifies the MIDI channel on which the UPPER keyboard will receive MIDI note messages. (The factory setting is channel 1.)

MIDI Upper Tx ch (MIDI Upper Transmit Channel)
[1...16, Off]

Specifies the channel on which the UPPER keyboard will transmit MIDI note messages with a fixed velocity value. (The factory setting is channel 1.) The velocity value is set by “MIDI Fixed Velcty.”

MIDI Upper 2nd ch (MIDI Upper 2nd Transmit Channel) [1...16, Off]

Specifies the channel on which the UPPER keyboard will transmit MIDI note messages with a variable velocity. (The factory setting is Off.)

Off: Messages will not be transmitted. Be sure to turn this Off unless you are using a MIDI sound module that requires variable velocity (such as a piano module).

 If you specify a MIDI channel for this parameter and are using a MIDI sound module etc. connected to the BX-3, set the Group 1 “Key Trigger” parameter to Deep.

MIDI Lower Rx ch (MIDI Lower Receive Channel)
[1...16]

Specifies the MIDI channel on which the LOWER keyboard will receive MIDI note messages. (The factory setting is 2.)

MIDI Lower Tx ch (MIDI Lower Transmit Channel)
[1...16, Off]

Specifies the channel on which the LOWER keyboard will transmit MIDI note messages with a fixed velocity value. (The factory setting is channel 2.) The velocity value is set by “MIDI Fixed Velcty.”

MIDI Lower 2nd ch (MIDI Lower 2nd Transmit Channel)
[1...16, Off]

Specifies the channel on which the LOWER keyboard will transmit MIDI note messages with a variable velocity. (The factory setting is Off.)

Off: Messages will not be transmitted. Be sure to turn this Off unless you are using a MIDI sound module that requires variable velocity (such as a piano module).

 If you specify a MIDI channel for this parameter and are using a MIDI sound module etc. connected to the BX-3, set the Group 1 “Key Trigger” parameter to Deep.

.....
Group 3: MIDI Parameters

MIDI Fixed Velcty (MIDI Fixed Velocity) [0...127]

Specifies the velocity value of the MIDI note messages that are transmitted with fixed velocity. (The factory setting is 80.)

MIDI Rx Prg Chng (MIDI Receive Program Change)
[Dis, Ena]

Dis (Disable): MIDI program changes received on the global MIDI channel will be ignored.

Ena (Enable): The BX-3 will respond to MIDI program changes received on the global MIDI channel. (The factory setting is Ena.)

MIDI Prog Mapper (MIDI Program Mapper) [Dis, Ena]

Dis (Disable): The program mapper will not be used when transmitting or receiving MIDI program changes.

Ena (Enable): The program mapper will be used when transmitting or receiving MIDI program changes. (The factory setting is Ena.)

MIDI Rx Sys Exc (MIDI Receive System Exclusive)
[Dis, Ena]

Dis (Disable): Incoming system exclusive data will be ignored. (The factory setting is Dis.)

Ena (Enable): Incoming system exclusive data will be received.

MIDI Rx C. Change (MIDI Receive Control Change) [Dis, Ena]

Dis (Disable): Incoming MIDI control changes will be ignored.

Ena (Enable): Incoming MIDI control changes will be received. (The factory setting is Ena.)

MIDI Tx C. Change (MIDI Transmit Control Change) [Dis, Ena]

Dis (Disable): MIDI control changes will not be transmitted.

Ena (Enable): MIDI control changes will be transmitted. (The factory setting is Ena.)

MIDI Local Cntrl (MIDI Local Control) [Off, On]

Turns local control on/off. (The factory setting is On.)

Off: The keyboard will be internally disconnected from the tone generator section. Select this setting when you want to use the keyboard and controllers of the BX-3 only to play a different tone generator.



Group 4: MIDI CC# 1

CC# Upper DB Sel (MIDI CC# Upper Drawbar Select) [1...31, 33...95, Off]

Specifies the MIDI control change number that will be used to transmit and receive the UPPER setting of the DRAWBAR SELECT section. (The factory setting is 79.)

CC# Lower DB Sel (MIDI CC# Lower Drawbar Select) [1...31, 33...95, Off]

Specifies the MIDI control change number that will be used to transmit and receive the LOWER setting of the DRAWBAR SELECT section. (The factory setting is 80.)

CC# Drawbar 1 16' (MIDI CC# Drawbar 1-16') [1...31, 33...95, Off]

Specifies the MIDI control change number that will be used to transmit and receive the 16' setting of Drawbar 1. (The factory setting is 16.)

CC# Drawbar 1 5¹/₃' (MIDI CC# Drawbar 1-5-1/3') [1...31, 33...95, Off]

Specifies the MIDI control change number that will be used to transmit and receive the 5-1/3' setting of Drawbar 1. (The factory setting is 17.)

CC# Drawbar 1 8' (MIDI CC# Drawbar 1-8') [1...31, 33...95, Off]

Specifies the MIDI control change number that will be used to transmit and receive the 8' setting of Drawbar 1. (The factory setting is 18.)

CC# Drawbar 1 4' (MIDI CC# Drawbar 1-4') [1...31, 33...95, Off]

Specifies the MIDI control change number that will be used to transmit and receive the 4' setting of Drawbar 1. (The factory setting is 19.)

CC# Drawbar 1 2²/₃' (MIDI CC# Drawbar 1-2-2/3') [1...31, 33...95, Off]

Specifies the MIDI control change number that will be used to transmit and receive the 2-2/3' setting of Drawbar 1. (The factory setting is 20.)

CC# Drawbar 1 2' (MIDI CC# Drawbar 1-2') [1...31, 33...95, Off]

Specifies the MIDI control change number that will be used to transmit and receive the 2' setting of Drawbar 1. (The factory setting is 21.)

CC# Drawbar 1 1³/₅' (MIDI CC# Drawbar 1-1-3/5') [1...31, 33...95, Off]

Specifies the MIDI control change number that will be used to transmit and receive the 1-3/5' setting of Drawbar 1. (The factory setting is 22.)

CC# Drawbar 1 1¹/₃' (MIDI CC# Drawbar 1-1-1/3') [1...31, 33...95, Off]

Specifies the MIDI control change number that will be used to transmit and receive the 1-1/3' setting of Drawbar 1. (The factory setting is 23.)

CC# Drawbar 1 1' (MIDI CC# Drawbar 1-1') [1...31, 33...95, Off]

Specifies the MIDI control change number that will be used to transmit and receive the 1' setting of Drawbar 1. (The factory setting is 24.)

CC# Drawbar 2 16' (MIDI CC# Drawbar 2-16') [1...31, 33...95, Off]

Specifies the MIDI control change number that will be used to transmit and receive the 16' setting of Drawbar 2. (The factory setting is 70.)

CC# Drawbar 2 5¹/₃' (MIDI CC# Drawbar 2-5-1/3') [1...31, 33...95, Off]

Specifies the MIDI control change number that will be used to transmit and receive the 5-1/3' setting of Drawbar 2. (The factory setting is 71.)

CC# Drawbar 2 8' (MIDI CC# Drawbar 2-8') [1...31, 33...95, Off]

Specifies the MIDI control change number that will be used to transmit and receive the 8' setting of Drawbar 2. (The factory setting is 72.)

CC# Drawbar 2 4' (MIDI CC# Drawbar 2-4') [1...31, 33...95, Off]

Specifies the MIDI control change number that will be used to transmit and receive the 4' setting of Drawbar 2. (The factory setting is 73.)

CC# Drawbar 2 2²/₃' (MIDI CC# Drawbar 2-2-2/3') [1...31, 33...95, Off]

Specifies the MIDI control change number that will be used to transmit and receive the 2-2/3' setting of Drawbar 2. (The factory setting is 74.)

CC# Drawbar 2 2' (MIDI CC# Drawbar 2-2') [1...31, 33...95, Off]

Specifies the MIDI control change number that will be used to transmit and receive the 2' setting of Drawbar 2. (The factory setting is 75.)

CC# Drawbar 2 1³/₅' (MIDI CC# Drawbar 2-1-3/5') [1...31, 33...95, Off]

Specifies the MIDI control change number that will be used to transmit and receive the 1-3/5' setting of Drawbar 2. (The factory setting is 76.)

Group 6: Ex Drawbar Set

Ex Drawbar Type 1-1 [-5...+24]

Specifies the pitch (in semitone steps) that will be assigned to the left bar (16') of the EX Drawbars (Drawbar 2) used by an EX program.

This setting will be used if the EX Edit mode Group 2 "Ex Drawbar Type" parameter is set to 1.

-5: Five semitones lower than the 1' drawbar.

0: The 1' drawbar.

+24: Two octaves (24 semitones) above the 1' drawbar.

Ex Drawbar Type 1-2 [-5...+24]

Specifies the pitch (in semitone steps) that will be assigned to the second-from-left bar (5-1/3') of the EX Drawbars (Drawbar 2) used by an EX program.

This setting will be used if the EX Edit mode Group 2 "Ex Drawbar Type" parameter is set to 1.

-5: Five semitones lower than the 1' drawbar.

0: The 1' drawbar.

+24: Two octaves (24 semitones) above the 1' drawbar.

Ex Drawbar Type 1-3 [-5...+24]

Specifies the pitch (in semitone steps) that will be assigned to the third-from-left bar (8') of the EX Drawbars (Drawbar 2) used by an EX program.

This setting will be used if the EX Edit mode Group 2 "Ex Drawbar Type" parameter is set to 1.

-5: Five semitones lower than the 1' drawbar.

0: The 1' drawbar.

+24: Two octaves (24 semitones) above the 1' drawbar.

Ex Drawbar Type 1-4 [-5...+24]

Specifies the pitch (in semitone steps) that will be assigned to the right bar (4') of the EX Drawbars (Drawbar 2) used by an EX program.

This setting will be used if the EX Edit mode Group 2 "Ex Drawbar Type" parameter is set to 1.

-5: Five semitones lower than the 1' drawbar.

0: The 1' drawbar.

+24: Two octaves (24 semitones) above the 1' drawbar.

Ex Drawbar Type 2-1 – Ex Drawbar Type 2-4 [-5...+24]

Specifies the pitches (in semitone steps) that will be assigned to the EX Drawbars (Drawbar 2) used by an EX program.

These settings will be used if the EX Edit mode Group 2 "Ex Drawbar Type" parameter is set to 2.

Ex Drawbar Type 3-1 – Ex Drawbar Type 3-4 [-5...+24]

Specifies the pitches (in semitone steps) that will be assigned to the EX Drawbars (Drawbar 2) used by an EX program.

These settings will be used if the EX Edit mode Group 2 "Ex Drawbar Type" parameter is set to 3.

Ex Drawbar Type 4-1 – Ex Drawbar Type 4-4 [-5...+24]

Specifies the pitches (in semitone steps) that will be assigned to the EX Drawbars (Drawbar 2) used by an EX program.

These settings will be used if the EX Edit mode Group 2 "Ex Drawbar Type" parameter is set to 4.

tips Pitches above the F#8 of the BX-3 will be "folded back" to the octave below, so we suggest that you play the lowest octave of the BX-3 to hear the pitches you specify here.

Group 7: Utility

Program Mapper

This lets you change the correspondence between the BX-3's program numbers and MIDI program numbers. Press the [WRITE/ENTER] key and the editing screen will appear. The BX-3's program number is shown in the left of the display, and the MIDI program number at the right. When you select an EX program, an "E" will be displayed at the left of the program number.

Use the [√] [▶] keys to select the BX-3 program number, and use the [-] [+] keys to select the MIDI program number.

Copy Swap Init

Copy (Copy Program)

This lets you copy a specified program. For details, refer to "Copying a program" (p.22).

Swap (Swap Program)

This lets you exchange two specified programs. For details, refer to "Swapping two programs" (p.22).

Init (Initialize)

This lets you return program or global settings to the factory settings. For details, refer to "3. Restoring the factory settings" (p.16).

Dump (MIDI Dump)

For details, refer to "MIDI data dump" (p.37).

Dump Program

Dumps the data for one specified program.

Dump All Program

Dumps the data for all programs.

Dump Global

Dumps the global data.

Dump All Data (Dump All Programs and Global data)

Dumps the data for all programs and global data.

Drawbar Scan

When the BX-3 receives MIDI control changes, the drawbar registers will be modified, so that the sound may no longer match the physical settings of the front panel Drawbar 1 and 2 bars.

When you execute Drawbar Scan, BX-3 will re-read the actual physical position of the Drawbar 1 and 2 settings, and their values will be set in the drawbar registers. Execute this when you want the settings of Drawbar 1 and 2 to be reflected in the sound. Since the control changes for all drawbars will be transmitted via MIDI when Drawbar Scan is executed, this is convenient when you want to record a BX-3 performance on your sequencer.

Default DB Select (Default Drawbar Select)



[PRESET, 1, 2]

This controls which settings in the DRAWBAR SELECT section will be active when the power is turned on.

1.  
2. Press the [WRITE/ENTER] key.





The display will allow you to specify your choice for the upper DRAWBAR SELECT section.

Upper DB Sel: PRESET#

3.  Press the **UPPER DRAWBAR SELECT** section PRESET: When the power is turned on, the [Preset Drawbar] key will be recalled.
 1: When the power is turned on, the [Drawbar 1] key will be recalled.
 2: When the power is turned on, the [Drawbar 2] key will be recalled.
4.  Press the **LOWER DRAWBAR SELECT** section PRESET: When the power is turned on, the [Preset Drawbar] key will be recalled.
 1: When the power is turned on, the [Drawbar 1] key will be recalled.
 2: When the power is turned on, the [Drawbar 2] key will be recalled.
5.  Press the **UPPER DRAWBAR SELECT** section PRESET: When the power is turned on, the [Preset Drawbar] key will be recalled.
 1: When the power is turned on, the [Drawbar 1] key will be recalled.
 2: When the power is turned on, the [Drawbar 2] key will be recalled.
6. Press the **[WRITE/ENTER]** key.
 When the settings have been registered, the display will indicate **DfltDB Set Completed**, and will then indicate **Default DB Select**.

Exp Pdl Calibration (Expression Pedal Calibration)

If operating the expression pedal connected to the rear panel EXPRESSION PEDAL jack does not produce the appropriate result, use the following procedure to adjust the sensitivity of the expression pedal.

1.  Press the **EXPRESSSION PEDAL** jack.
2.  Press the **[WRITE/ENTER]** key.
 The display will indicate **Set ExpPdl Min Pos**.
4.  Press the **[WRITE/ENTER]** key.
 The display will indicate **Set ExpPdl Max Pos**.
5.  Press the **[WRITE/ENTER]** key.

Wheel Brake ON

This simulates the way in which the tone wheel rotation slows down when the power of a tone wheel organ is switched on/off.
 When you press the **[WRITE/ENTER]** key, the tone wheel rotation will gradually slow down and stop. At this time, the pitch will also fall. Press the **[WRITE/ENTER]** key once again, and tone wheel rotation will gradually resume.



Group 8: DEMO

DEMO Play **[1...9]**

Here you can select and play back the demo songs.
 For details, refer to "1. Listening to the demo songs" (p.11).

Appendices

1. How the drawbars work

Drawbar 1 and Drawbar 2 each consist of a set of nine bars.

In Normal mode and Normal Edit mode, these bars have the following functions.

- 16': The pitch one octave below the note you play
- 5-1/3': The pitch a fifth above the note you play
- 8': The pitch of the note you play
- 4': The pitch one octave above the note you play
- 2-2/3': The pitch one octave and a fifth above the note you play
- 2': The pitch two octaves above the note you play
- 1-3/5': The pitch two octaves and a third above the note you play
- 1-1/3': The pitch two octaves and a fifth above the note you play
- 1': The pitch three octaves above the note you play

The white drawbars (8', 4', 2', 1') produce fundamentals. The black drawbars (2-2/3', 1-3/5', 1-1/3') produce pitches that are a fifth or a third above these fundamental pitches. The brown drawbars (16' and 5-1/3') add depth to the tone.

Pulling out the four right bars to a greater extent will produce a harder-toned sound, while pulling out the two left bars to a greater extent will produce a softer tone.

For example when you play middle C, each bar corresponds to the pitches shown in the diagram below. The further a bar is pulled out, the greater its volume will be.

For details on the function of the Drawbar 2 bars (EX Drawbar, EX Percussion) in EX mode and EX Edit mode, refer to the Drawbar 2 illustration (p.13), to the EX Edit mode Group 2 "Ex Drawbar Type" parameter, and to the Global mode Group 8 "Type 1 Ex Drawbar 1" through "Type 4 Ex Drawbar 4" parameters.

The BX-3 simulates 79 tone wheels that produce the notes from C2 to F#8, just as on traditional tone wheel organs. This means that if the drawbar settings could cause the pitch to exceed the range of C2 through F#8, the pitch will "wrap around" to the previous octave.

2. MIDI applications

About MIDI

MIDI stands for Musical Instrument Digital Interface, and is a world-wide standard that allows various performance-related data to be exchanged between electronic musical instruments and computers. If a MIDI cable is used to connect MIDI devices, performance data can be exchanged even between electronic musical instruments or computers made by different manufacturers.

Connecting an external MIDI sequencer or computer

If you want to play the keyboard of the BX-3 and record your playing on an external MIDI sequencer/computer (connected via a MIDI interface) while using the BX-3's tone generator to monitor your performance and the playback, or if you want to use the BX-3 as an input keyboard and as a MIDI tone generator, connect the MIDI OUT and MIDI IN connectors of the BX-3 and the external MIDI sequencer/computer to each other respectively.

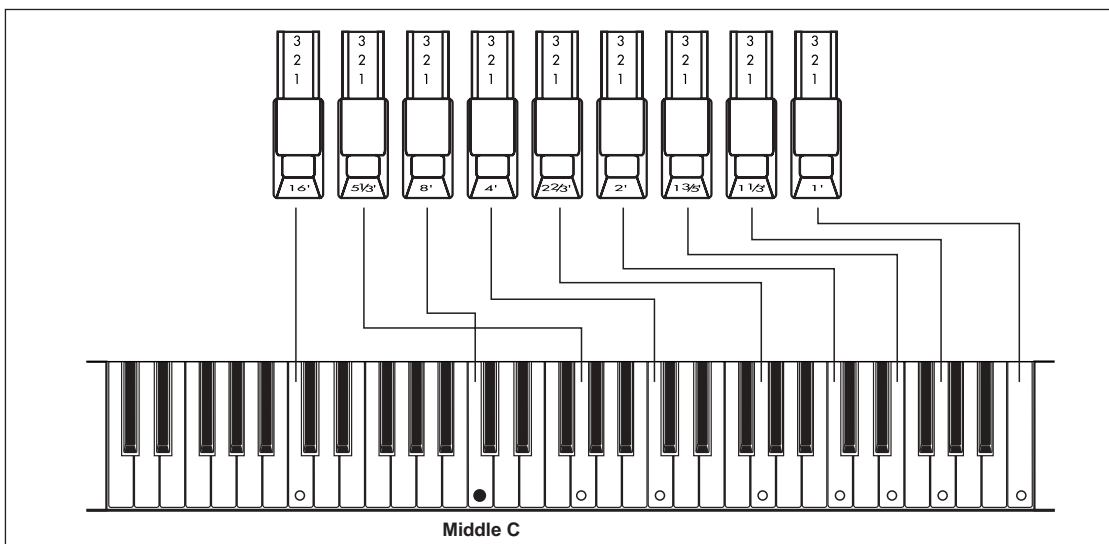
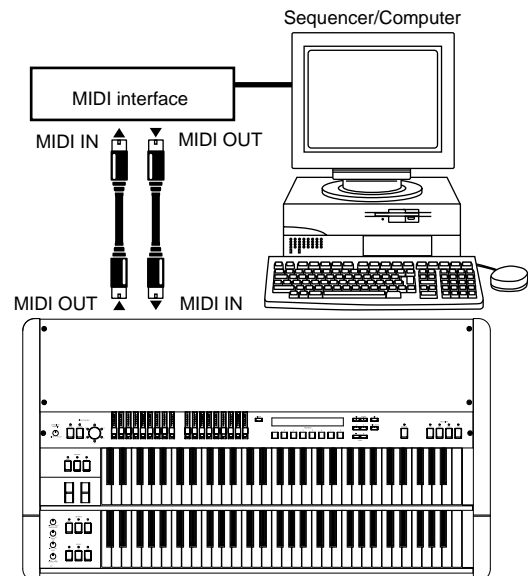



Local Control On setting

If you make connections as shown on the preceding page, you must turn on the Echo Back setting of the external MIDI sequencer or computer (so that the data it receives at MIDI IN will be retransmitted without change from MIDI OUT), and turn **off the Local Control** setting of the BX-3 (to disconnect the keyboard section from the tone generator section).

When you play the keyboard of the BX-3, the data will be sent to the external MIDI sequencer or computer, and will be echoed back to sound the tone generator of the BX-3. In other words by turning the BX-3's **Local Control off**, you can prevent notes from being sounded in duplicate; once from the keyboard and again from the echo-back.

To turn off Local Control, set the Global mode Group 4 "MIDI Local Cntrl" parameter to Off.

If you are using the BX-3 by itself, you must turn Local Control on. (If this is off, playing the BX-3's keyboard will produce no sound.)



Connecting a MIDI keyboard

If you want to connect a MIDI keyboard to the BX-3's MIDI IN connector and use the BX-3 as a sound module, you will need to set the following parameters.

Set the Global mode Group 2 "MIDI Upper Rx ch" and "MIDI Lower Rx ch" parameters to match the MIDI channel of your connected MIDI device.

If you want to transmit program changes from the connected MIDI device or to control the panel keys of the BX-3, set the Global mode Group 2 "MIDI Global ch" parameter to match the transmit channel of the connected MIDI device. MIDI control change numbers can be set in Group 4 and 5.

If you are recording your BX-3 performance on a sequencer, and want the state of all panel keys to be reproduced, use the following procedure.

Since Drawbar 1, 2, and DRAWBAR SELECT are not reproduced by program changes, use DRAWBAR SELECT to select the drawbars that you will use first in your performance. Then execute Global mode Group 7 "Drawbar Scan" to transmit the state of Drawbar 1 and 2.

Immediately when you begin recording, transmit a program change by selecting the program that you will use for your performance. Now the sequence will contain the data needed to reproduce the settings for each live set of drawbars.



When using a velocity-sensitive MIDI sound module

With the factory settings, the BX-3 is set to transmit note messages with a fixed velocity.

If you are using a velocity-sensitive MIDI sound module, you will need to set the following parameters.

Set the Global mode Group 2 "MIDI Upper 2nd ch" and "MIDI Lower 2nd ch" parameters to other than Off. This will cause note messages with velocity to be transmitted on the specified MIDI channel.

However in this state, two sets of note messages (one

with variable velocity, and another with fixed velocity) will be transmitted, so you should also set the Global mode Group 2 "MIDI Upper Tx ch" and "MIDI Lower Tx ch" parameters to Off, so that the fixed-velocity note messages will not be transmitted.

Alternatively, you could set "MIDI Upper 2nd ch" and "MIDI Upper Tx ch," and "MIDI Lower 2nd Tx Ch" and "MIDI Lower Tx Ch," to different channels so that they do not conflict, and then make settings on the connected MIDI sound module so that it receives the note messages with variable velocity.

 If Global mode Group 1 "Key Trigger" is set to Shallow, the note message with fixed velocity will be transmitted when you have only pressed the key lightly. However, the note message with variable velocity will not be transmitted until you have pressed the key all the way. This means that if you have made settings to transmit note messages with variable velocity, it is possible for the BX-3 to produce sound without a note message being transmitted. In order to match the timing at which the BX-3 sounds with the timing at which your MIDI sound module will sound, set the "Key Trigger" parameter to Deep.

MIDI data dump

Exclusive data (internal settings) can be transmitted from the BX-3 to a connected MIDI data filer or another BX-3.

Transmission

 While data is being transmitted, do not touch the keys, drawbars, or knobs of the BX-3. Also, never turn off the power of the BX-3 while data is being transmitted.

The following four types of data dump can be transmitted.

- Dump one program
- Dump all programs
- Dump global data
- Dump all data (programs and global data)

To transmit a data dump

1. Connect the MIDI OUT connector of the BX-3 to the MIDI IN connector of the device that will receive the data dump.

2. Enter Global mode.
The key LED will light.

3. Press the PROGRAM [7] key, and then press the [▶] key twice.
The display will indicate **Dump**.

4. Press the [WRITE/ENTER] key.
The display will indicate **Dump Program**, and "Program" will blink.

5. Select the data that you want to dump.
If you want to dump **one program**, press the [▶] key once, and then use the [-][+] keys to select the program.

The programs that will be dumped will be the programs contained in the mode that was selected before

3. Voice name list

Mod Wheel assign = "Click Level"

| Genre | Jazz Perc | Mellow | Rock 1 | Gospel | R&B | Jazz | Rock 2 | Church | |
|------------|--------------------|--------------------|--------------------|---------------------|--------------------|--------------------|---------------------|--------------------|----------|
| Bank / No. | 1 | 2 | 3 | 4 | 5 | 6 | 7 | 8 | |
| Name | Pedal1/2 | Name | Pedal1/2 | Name | Pedal1/2 | Name | Pedal1/2 | Name | Pedal1/2 |
| A | Organized RF/-- | Comp RF/-- | Felix'sDaKat RF/-- | BC Gospel 1 RF/-- | Classic Soul RF/-- | Joey's LH RF/-- | DS Balls! RF/-- | Quiet Hymn 2 RF/-- | |
| B | Bro' J RF/-- | LS Jazz RF/-- | BC LowerComp RF/-- | Preachin' RF/-- | ShoTown RF/-- | LS Fats "W" RF/-- | Turkish RF/WB | Dulciana RF/-- | |
| C | Cat On aMojo RF/-- | Jazz Comp RF/-- | Whyter Shade RF/-- | GP GonZChurch RF/-- | Huggipz RF/-- | TC Bass Comp RF/-- | SmokeInJapan --/-- | Salcional RF/-- | |
| D | BA PercSplit --/-- | BA Mellow --/-- | Carpet Magic RF/-- | Keepin' On RF/-- | LS DirtyFunk RF/-- | Blueznotes RF/-- | AK ChestBnd RF/-- | DM Hymn Pt2 RF/-- | |
| E | GP NicePerc RF/-- | Barfly RF/-- | Nice Chords RF/-- | LS GospelFunk RF/-- | BC Schnoz RF/-- | Jazz Ballad RF/-- | Mr. Nice :-) RF/-- | French Horn RF/-- | |
| F | Go McJimmy RF/-- | Joey' Jazz RF/-- | Gimme Some RF/-- | BC Gospel 2 RF/-- | Wat's Up? RF/-- | Slow Groove RF/-- | Deep Hush RF/-- | Oboe Horn RF/-- | |
| G | BC Best Solo RF/-- | AK Smooth"J" RF/-- | AK OnionBook RF/-- | TC SoufulSP RF/-- | Smoothie RF/-- | Perc Combo --/-- | BC Rock Solo RF/-- | Quiet Hymn 1 RF/-- | |
| H | GP MintJewel RF/-- | BA THE Sound --/-- | Voximental --/-- | BC Best Full RF/-- | Memphis Soul RF/-- | TC Celeste RF/-- | Whirly Perc RF/-- | DM Hymn Pt1 RF/-- | |

Mod Wheel assign = "Ex Lm Level"

| Genre | Standard 1 | Pipe Organ | Attack | EX Mellow | Bright | Clean/Perc | Combo | Standard 2 | |
|------------|--------------------|--------------------|-------------------|--------------------|-----------------|--------------------|--------------------|-------------------|----------|
| Bank / No. | 1 | 2 | 3 | 4 | 5 | 6 | 7 | 8 | |
| Name | Pedal1/2 | Name | Pedal1/2 | Name | Pedal1/2 | Name | Pedal1/2 | Name | Pedal1/2 |
| A | I Gota EX! RF/-- | Pipe Organ 1 --/-- | EX Perky 2 RF/-- | EX Gentle 1 RF/-- | Mixture 1 RF/-- | Clean 1 RF/-- | Combo 1 --/-- | EX Full 1 RF/-- | |
| B | TC EX-Glassy RF/-- | Pipe Organ 2 --/-- | EX Perky 3 RF/-- | Clean 5 RF/-- | Mixture 2 RF/-- | Clean 2 RF/-- | Combo 2 --/-- | EX Full 2 RF/-- | |
| C | EX Rock Perc RF/-- | Pipe Organ 3 --/-- | Attack 1 RF/-- | Clean 6 RF/-- | Mixture 3 RF/-- | Clean 3 RF/-- | Combo 3 --/-- | EX NuHi RF/-- | |
| D | B Leakn RF/-- | Full Pipes --/-- | Attack 2 RF/-- | EX Sweet 1 RF/-- | Mixture 4 RF/-- | Clean 4 RF/-- | Combo 4 --/-- | EX Otones 2 RF/-- | |
| E | Attack Fat RF/-- | Mix Bright 1 --/-- | Attack 3 RF/-- | EX Gentle 2 RF/-- | EX All RF/-- | Percussion 1 RF/-- | Combo 5 --/-- | EX Rockin RF/-- | |
| F | EX Mr.Nice RF/-- | EX Church RF/-- | Metal 1 RF/-- | EX Sweet 2 RF/-- | Bright 1 RF/-- | Percussion 2 RF/-- | Combo 6 RF/-- | EX Wisfl RF/-- | |
| G | TC EX-Fusion RF/-- | EX Chapel RF/-- | Metal 2 RF/-- | Comp+Perc RF/-- | Bright 2 RF/-- | Percussion 3 RF/-- | Callope Lead RF/-- | Whistler RF/-- | |
| H | EX Perky 1 RF/-- | EX Hymnal RF/-- | EX Otones 1 RF/-- | Mix Bright 2 RF/-- | Gen-EX! RF/-- | EX Bass --/-- | Toy Organ RF/-- | Throaty! RF/-- | |

EX mode programs

Mod Wheel assign = "Click Level"

| Genre | Jazz Perc | Mellow | Rock 1 | Gospel | R&B | Jazz | Rock 2 | Church | |
|------------|--------------------|--------------------|--------------------|---------------------|--------------------|--------------------|---------------------|--------------------|----------|
| Bank / No. | 1 | 2 | 3 | 4 | 5 | 6 | 7 | 8 | |
| Name | Pedal1/2 | Name | Pedal1/2 | Name | Pedal1/2 | Name | Pedal1/2 | Name | Pedal1/2 |
| A | Organized RF/-- | Comp RF/-- | Felix'sDaKat RF/-- | BC Gospel 1 RF/-- | Classic Soul RF/-- | Joey's LH RF/-- | DS Balls! RF/-- | Quiet Hymn 2 RF/-- | |
| B | Bro' J RF/-- | LS Jazz RF/-- | BC LowerComp RF/-- | Preachin' RF/-- | ShoTown RF/-- | LS Fats "W" RF/-- | Turkish RF/WB | Dulciana RF/-- | |
| C | Cat On aMojo RF/-- | Jazz Comp RF/-- | Whyter Shade RF/-- | GP GonZChurch RF/-- | Huggipz RF/-- | TC Bass Comp RF/-- | SmokeInJapan --/-- | Salcional RF/-- | |
| D | BA PercSplit --/-- | BA Mellow --/-- | Carpet Magic RF/-- | Keepin' On RF/-- | LS DirtyFunk RF/-- | Blueznotes RF/-- | AK ChestBnd RF/-- | DM Hymn Pt2 RF/-- | |
| E | GP NicePerc RF/-- | Barfly RF/-- | Nice Chords RF/-- | LS GospelFunk RF/-- | BC Schnoz RF/-- | Jazz Ballad RF/-- | Mr. Nice :-) RF/-- | French Horn RF/-- | |
| F | Go McJimmy RF/-- | Joey' Jazz RF/-- | Gimme Some RF/-- | BC Gospel 2 RF/-- | Wat's Up? RF/-- | Slow Groove RF/-- | Deep Hush RF/-- | Oboe Horn RF/-- | |
| G | BC Best Solo RF/-- | AK Smooth"J" RF/-- | AK OnionBook RF/-- | TC SoufulSP RF/-- | Smoothie RF/-- | Perc Combo --/-- | BC Rock Solo RF/-- | Quiet Hymn 1 RF/-- | |
| H | GP MintJewel RF/-- | BA THE Sound --/-- | Voximental --/-- | BC Best Full RF/-- | Memphis Soul RF/-- | TC Celeste RF/-- | Whirly Perc RF/-- | DM Hymn Pt1 RF/-- | |

Demo song names

- 1 Y's Groovin'
- 2 Katana
- 3 Church Hymn
- 4 TC Kool Blues
- 5 GP Jazz Waltz
- 6 BC CX Prelude
- 7 GP Gospel
- 8 Samba de Rit
- 9 Mama takes me

All songs copyright by KORGE Inc.

* Special thanks for preset voicing and demo songs

- BA: Brian Auger
- GP: Greg Phillinganes
- AK: Al Kooper
- BC: Bill Champlin
- TC: Tom Coster
- LS: Lonnie Smith
- DM: Don Muro
- DS: Derek Sherinian
- and more

Pedal1/2: "Assignable Pedal/SW 1" / "Assignable Pedal/SW 2" settings.
 RF: Rotary Fast control
 WB: Wheel Brake control
 --: off

4. Troubleshooting

Power does not turn on

- Is the power cable connected to an outlet?
Check the connection. (see p.10)
- Is the power switch turned ON?
Check the on/off setting of the power switch.

No sound

- Are the connected devices or headphones connected correctly?
Check the connections. (see p.10)
- Are your amp and/or mixer turned on?
- Is the [MASTER LEVEL] knob turned up?
- Is the Global mode Group 3 "Local Control" parameter turned On?
Check the parameter settings.
- Are the Drawbar 1 and 2 bars pulled out?
Pull out the bars.

Sound does not change when you move Drawbar 1 or 2 bars

- Is the DRAWBAR SELECT section set correctly?
If you want to play using the bars, select the [DRAWBAR 1] key or [DRAWBAR 2] key in the DRAWBAR SELECT section. (see p.12, 13)

Percussion does not sound

- Are the settings of the DRAWBAR SELECT section correct?
If you want to use the PERCUSSION section keys, select the [DRAWBAR 2] key in the upper DRAWBAR SELECT section. (see p.17)
- Is the Normal Edit mode "DB Preset's Perc" parameter set to Enable (Ena)?
Check the parameter setting. (see p.17)
- Are the percussion-related parameters set correctly?
The Normal Edit mode "Percussion Nrml Level" parameter value plus the "Percussion Soft Off" parameter value will be the level of the soft percussion. If this is zero or less, the percussion will not be heard when Soft is selected. (see p.25)

Rotary speaker effect cannot be obtained

- Is the amp selection correct?
For the Normal Edit mode or EX Edit mode Group 4 "Amp Type" parameter, select either Type 1 or Type 2. The rotary speaker will not be used if you select Pre Amp. (see p.18)

The BX-3 does not response to incoming MIDI messages

- Is the MIDI cable connected correctly?
Check the connection. (see p.10)
- Does the global MIDI channel match?
Check the setting.

The BX-3 does not respond correctly to incoming MIDI messages

- If you want to receive MIDI exclusive messages, is the "MIDI Rx Sys Exc" parameter set to Enable (Ena)?
Check the parameter setting.
- Does the BX-3 support the message that is being transmitted?

Pedal switch or expression pedal connected to the rear panel does not operate as you intend

- Is Pedal 1 or Pedal 2 selected for the Global mode Group 1 "Prog Up Ctrl" or "Prog Down Ctrl" parameter?
It is possible to assign more than one function to a pedal switch or expression pedal. However if a pedal switch etc. is selected by the Global mode Group 1 "Prog Up Ctrl" or "Prog Down Ctrl" parameter, the Global mode setting will take priority, and the Normal Edit mode and EX Edit mode settings will not be used. Please check the settings of these parameters.

An external MIDI device acts in unexpected ways when connected to the BX-3

- Is there a CC# conflict?
Most operations of the BX-3's front panel keys and drawbars etc. can be transmitted as CC# (control change number) messages, and with the factory settings, control changes that differ from those used by typical MIDI devices are assigned. This means that when another device is connected to the BX-3 via MIDI, the control changes of the BX-3 may coincide with differing functions on the external MIDI device, causing it to operate in unexpected ways. Check the control change related parameters in Global mode Group 4 and 5, and turn unneeded parameters off or change their control change number.

5. Operation of included Expression pedal

Cable storage

Store the cable as shown.

Fortissimo function

This allows you to selectively emphasise parts of your performance.

As shown in the diagram, the pedal angle is 30° when fully raised. The pedal will rest at any point you take your foot off from fully raised to standard position.

If you depress the pedal further from standard position, it will return to standard position when you take your foot off.

Also, by adjusting the screw on the bottom, you may adjust the spring return range from 0°–10°.

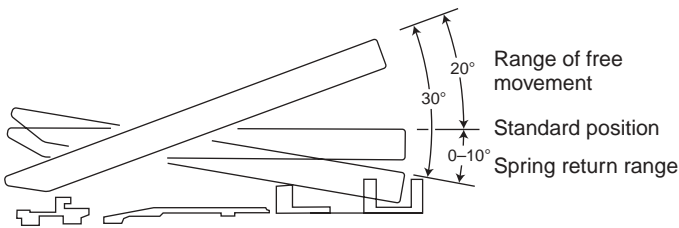
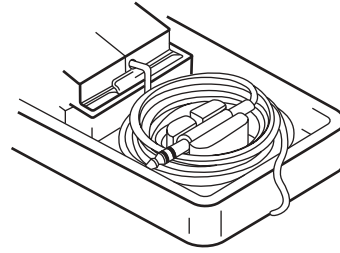

Selectable pedal angle

As shown below, you may change the pedal angle to fit your plying position.

To select pedal angle

1. Loosen hook screw with a screwdriver.
2. Move the pedal body to the position in the illustration.
3. Retighten the hook screw.

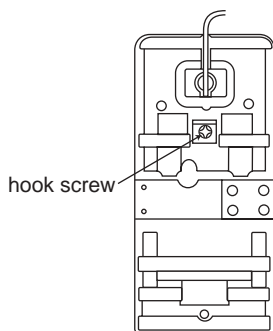
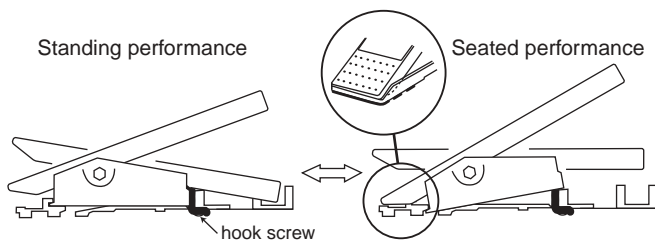

6. Specifications and options

Tone generator section

Tone generator: Tone wheel organ modeling tone generator

Polyphony: Full keyboard polyphony

Modes

Normal mode, EX mode, Normal Edit mode, EX Edit mode, Global mode

Effect section

Vibrato/chorus, rotary speaker, overdrive, reverb

Number of programs

Normal mode: 64 (A-1–H-8)

EX mode: 64 (A-1–H-8)

Keyboard

61 note x 2

Controllers

DRAWBAR SELECT section (for UPPER Keyboard): [DRAWBAR 1] key, [DRAWBAR 2] key, [PRESET DRAWBAR] key

DRAWBAR SELECT section (for LOWER Keyboard): [DRAWBAR 1] key, [DRAWBAR 2] key, [PRESET DRAWBAR] key (these are for the Lower tone generator)

DRAWBAR section: Drawbar 1, Drawbar 2

PERCUSSION section: [ON] key, [SOFT] key, [FAST] key, [3rd] key

ROTARY section: [ON] key, [STOP] key, [FAST] key

VIBRATO CHORUS section: [UPPER] key, [LOWER] key, [VIBRATO/CHORUS] knob

AMP section: [MASTER LEVEL] knob, [TREBLE] knob, [BASS] knob, [REVERB OFFSET] knob

Other: [EXPRESSION/OVERDRIVE] knob, [DISPLAY] key, [EX MODE] key, [EDIT] key, [GLOBAL] key, [WRITE/ENTER] key, [EXIT] key, PROGRAM [1]–[8] keys, [√] [▶] keys, [+]/[–] keys, Bender wheel, Modulation wheel

Outputs

OUTPUT L, R jacks:

Maximum output level +17.5 [dBu]

Load impedance 10 [k-ohm] or more

PHONES jack:

Maximum output level 50 mw @ 32 ohms / channel

Control inputs

EXPRESSION PEDAL jack

ASSIGNABLE PEDAL/SW 1, 2 jacks

Other

MIDI IN connector, MIDI OUT connector, MIDI THRU controller, AC power supply connector, Power switch

Power supply

AC Local voltage

Dimensions (W x D x H)

1,102 x 620 x 944 mm / 43.39 x 24.41 x 37.17 inches (BX-3 Stand STD-BX3 included)

1,102 x 620 x 221 mm / 43.39 x 24.41 x 8.70 inches (including rubber feet)

Weight

50 kg / 110.23 lbs. (BX-3 Stand STD-BX3 included)

32 kg / 70.55 lbs. (Only BX-3)

Power consumption

14 W

Included items

Power cable, Expression pedal, Stand STD-BX3

Options

XVP-10 EXP/VOL pedal, EXP-2 Foot Controller, PS-1 Pedal Switch, MIDI cable

*Appearance and specifications of this product may change without notice. (As of March, 2002.)

7. Assembling the stand

How to assemble the stand (STD-BX3)



Caution

Two or more persons are required in order to assemble the stand.

Cautions for assembly

Please observe the following points to ensure that the stand is assembled correctly.

- Perform the assembly steps in the specified order, making sure that you use the correct parts and that they are in the correct orientation.
- If you jar the organ before fastening it to the stand, it may fall over. Please be careful.

Assembly procedure

You will need to provide a Philips screwdriver.

1. Open the carton and take out the parts.

Make sure that you have the following parts.

Side panel (L) / Panneau latéral (G)

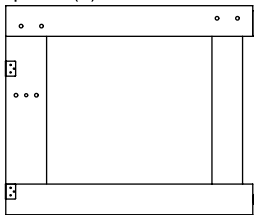

Side panel (R) / Panneau latéral (D)

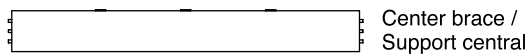
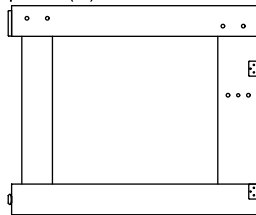

Center brace / Support central

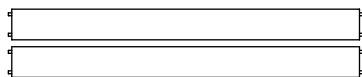

Rear brace x 2 / Support arrière x 2

Plastic bag / Sac en plastique

Bolts... 14 pcs. (includes two spares) /
Vis... 14 pcs (y compris deux vis de rechange)



Wing knobs... 4 pcs. /
Boulons à ailettes... 4 pcs

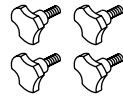

2. Lightly attach the rear braces to the side panel (L).

Insert the two protrusions on the left ends of the rear braces into the holes of the side panel (L), and lightly fasten them in place using four bolts. Do not tighten these bolts yet.

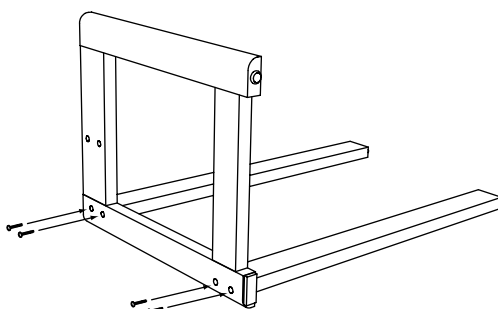

7. Assemblage du pupitre

Méthode d'assemblage du pupitre (STD-BX3)



ATTENTION :

Deux ou davantage de personnes sont nécessaires pour procéder à l'assemblage du pupitre.

Précautions à prendre pour le montage

Respecter les points suivants pour s'assurer que le pupitre est monté correctement.

- Procéder à l'assemblage en respectant les étapes dans l'ordre spécifié, en s'assurant d'utiliser les éléments adéquats et dans le sens correct.
- Si l'orgue est heurté avant d'être fixé au pupitre, il risque de tomber. Faire très attention à ce point.

Méthode d'assemblage

S'équiper au préalable d'un tournevis Philips.

1. Ouvrir le carton d'emballage et en sortir tous les éléments.

Vérifier si les éléments suivants sont présents

2. Fixer légèrement les supports arrière au panneau latéral (G)

Insérer les deux saillies des extrémités gauches des supports arrière dans les orifices du panneau latéral (G), puis les fixer légèrement à l'aide de quatre vis. Ne pas serrer les vis à ce stade.

3. Lightly attach the rear braces to the side panel (R).

Insert the two protrusions on the other ends of the rear braces into the holes of the side panel (R), and lightly fasten them in place using four bolts. Do not tighten these bolts yet.

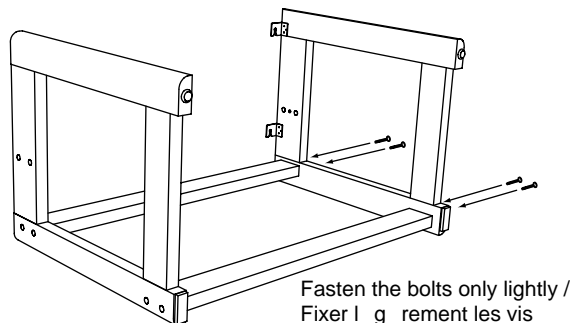

4. Attach the center brace.

Position the felted side of the center brace away from yourself. Insert the protrusions on one end of the center brace into the holes of one side panel, and then insert the protrusions on the other end into the holes of the other side panel.

⚠ If you attempt to force the center brace into place, the side panels or back braces may break. If you have difficulty, loosen the bolts that you fastened in steps 2 and 3.

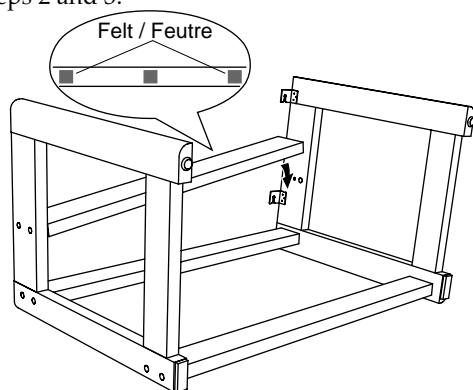

5. Use bolts to fasten the center brace.

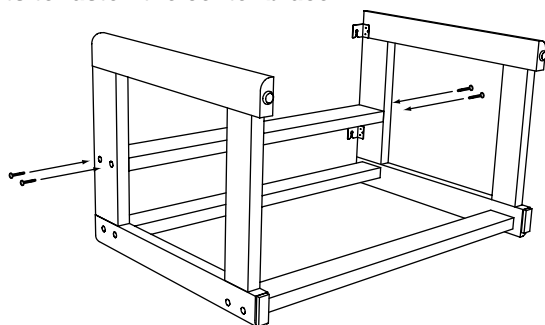

6. Firmly tighten all bolts that have not yet been tightened.

7. Make sure that there are no gaps between the parts of the stand, that the stand is not crooked, and that all bolts are securely tightened.

8. If the stand wobbles, rotate the two adjusters so that the stand firmly contacts the floor.

⚠ Be careful not to pinch your hand while making adjustments.

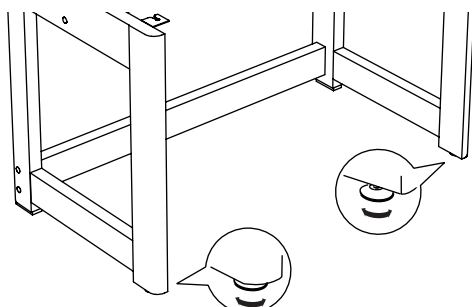

3. Fixer légèrement les supports arrière au panneau latéral (D)

Insérer les deux saillies des extrémités gauches des supports arrière dans les orifices du panneau latéral (D), puis les fixer légèrement à l'aide de quatre vis. Ne pas serrer les vis à ce stade.

4. Mettre le support central en place.

Tourner le côté feutré du support central vers l'extérieur. Insérer les saillies d'une extrémité du support central dans les orifices d'un panneau latéral puis insérer les saillies de l'autre extrémité dans les orifices de l'autre panneau latéral.

⚠ Ne pas forcer pour mettre le support central en place sinon les panneaux latéraux ou les supports arrière risquent de casser. En cas de difficulté, desserrer les vis fixées aux étapes 2 et 3.

5. Fixer le support central à l'aide de vis

6. Serrer convenablement toutes les vis qui sont encore lâches.

7. Vérifier qu'il ne reste pas d'espace entre les différents éléments du pupitre et si le pupitre n'est pas de travers. Vérifier également si toutes les vis sont bien serrées.

8. Si le pupitre est bancal, tourner les deux vis de réglage de sorte qu'il repose correctement sur le sol.

⚠ Faire attention de ne pas se pincer les mains lors des réglages.

9. Attach the organ to the stand.

Place the organ on the stand, and use the four wing knobs to fasten it from below.

- ⚠ When placing the organ on the stand, be careful not to pinch your hand. Lower the organ slowly onto the stand, and do not drop it.

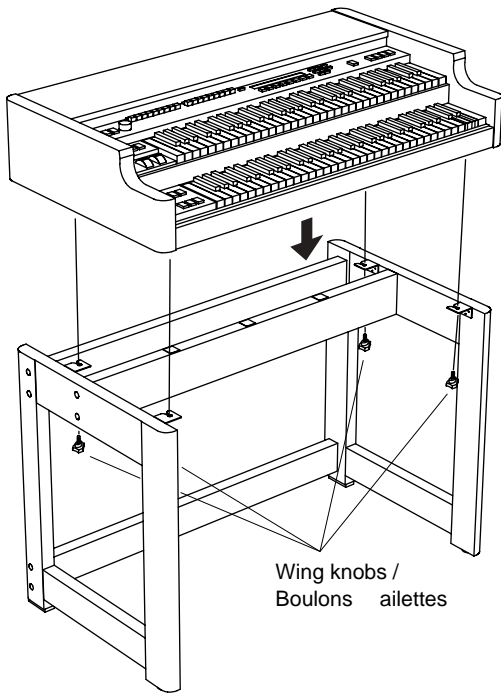

Check after assembly

- Make sure that none of the bolts are loose.

Other cautions

After assembly, please observe the following cautions.

- **Loosened bolts**
As time passes after assembly, bolts may come loose. We recommend that you regularly check for loose bolts. If you feel that the stand sways, it is possible that the bolts are loose. Please re-tighten the bolts.
- **Transport**
Remove the organ from the stand, and transport the organ and stand separately. After transport, reattach the organ as described in these instructions.
- **Disassembly**
If it is necessary to disassemble the stand, do so in the reverse order of assembly. After disassembly, save the bolts and other parts so that they are not lost.

9. Fixer l'orgue au pupitre

Placer l'orgue sur le pupitre et l'attacher par en dessous à l'aide des quatre boulons à ailettes.

- ⚠ Lors de la mise en place de l'orgue sur le pupitre, faire attention de ne pas se coincer la main. Abaisser l'orgue lentement sur le pupitre, sans le lâcher.

Vérification après montage

- Vérifier si aucune des vis ou des boulons ne sont lâches.

Autres précautions à prendre

Après le montage, prendre les précautions suivantes :

- **Vis et boulons desserrés**
Au fil du temps, après le montage, les vis et boulons risquent de se desserrer. Nous vous recommandons dès lors de les inspecter régulièrement pour voir s'ils sont bien serrés. Si le pupitre semble vaciller, il est possible que les vis et boulons soient trop lâches. Dans ce cas, il convient de les resserrer.
- **Transport**
Retirer l'orgue du pupitre pour transporter les deux éléments séparément. Après le transport, fixer de nouveau l'orgue au pupitre comme expliqué dans ces instructions.
- **Démontage**
Si le démontage du pupitre s'avère nécessaire, procéder dans l'ordre inverse au montage. Après le démontage, conserver soigne

8. MIDI implementation chart

[COMBO ORGAN]
BX-3

Date : 2001. 10. 23
Ver. 1.0

| Function | | Transmitted | Recognized | Remarks |
|------------------|----------------------|-------------|------------|--------------------------------|
| Basic Channel | Default | 1 – 16 | 1 – 16 | Memorized |
| | Changed | 1 – 16 | 1 – 16 | |
| Mode | Memorized | X | 3 | |
| | Messages | X | X | |
| | Altered | ***** | | |
| Note Number | | 36 – 96 | 36 – 96 | |
| | True Voice | ***** | 36 – 96 | |
| Velocity | Note On | 1 – 127 | X | |
| | Note Off | 0 – 127 | X | |
| Aftertouch | Polyphonic (Key) | X | X | |
| | Monophonic (Channel) | X | X | |
| Pitch Bend | | O | O | |
| Control Change | 1 | O | O | Modulation *1 |
| | 16 – 24 *2 | O | O | Drawbar 1 *1 |
| | 70 – 78 *2 | O | O | Drawbar 2 *1 |
| | 81, 82, 83 *2 | O | O | Rotary ON FAST STOP *1 |
| | 84, 85, 86 *2 | O | O | V/C Select Upper Lower *1 |
| | 87, 88, 94, 95 *2 | O | O | Percussion ON SOFT FAST 3rd *1 |
| | 79 *2 | O | O | Upper Drawbar Select *1 |
| | 80 *2 | O | O | Lower Drawbar Select *1 |
| | 11 *2 | O | O | Expression *1 |
| | 64 *2 | O | O | Hold *1 |
| | 93 *2 | O | O | Wheel Brake *1 |
| | 92 *2 | O | O | AMP Gain *1 |
| | 91 *2 | O | O | Reverb Level *1 |
| Program Change | | O 0 – 127 | O 0 – 127 | *3 |
| | Variable Range | ***** | 0 – 127 | |
| System Exclusive | | O | O | *4, *5 |
| System Common | Song Position | X | X | |
| | Song Select | X | X | |
| | Tune | X | X | |
| System Real Time | Clock | X | X | |
| | Command | X | X | |
| Aux Messages | Local On/Off | X | X | |
| | All Notes Off | X | O | |
| | Active Sense | X | X | |
| | Reset | X | X | |

Notes *1: Transmitted and received when Global MIDI Tx C.Chng and MIDI Rx C.Chng are set to "ENA" are respectively ENA.
 *2: Factory setting. User editable.
 *3: Received when Global mode MIDI Rx PrgChng parameter is set to "ENA".
 *4: Received when Global mode MIDI Rx Sys Exc parameter is set to "ENA".
 *5: In addition to Korg exclusive messages, Inquiry and Master Volume are supported.

Mode 1: OMNI ON, POLY
 Mode 3: OMNI OFF, POLY

Mode 2: OMNI ON, MONO
 Mode 4: OMNI OFF, MONO

O : Yes
 X : No

Consult your local Korg distributor for more information on MIDI IMPLEMENTATION.