

Color TV
with built-in DVD player

CDV19BPH

Owner's Manual

Important!
Return your *Warranty Registration Card* within 10 days. See why inside.



PHILIPS

Return your Warranty Registration card today to ensure you receive all the benefits you're entitled to.

Once your PHILIPS purchase is registered, you're eligible to receive all the privileges of owning a PHILIPS product. So complete and return the Warranty Registration Card enclosed with your purchase at once. And take advantage of these important benefits.

Warranty Verification

Registering your product within 10 days confirms your right to maximum protection under the terms and conditions of your PHILIPS warranty.

Owner Confirmation

Your completed Warranty Registration Card serves as verification of ownership in the event of product theft or loss.

Model Registration

Returning your Warranty Registration Card right away guarantees you'll receive all the information and special offers which you qualify for as the owner of your model.

PHILIPS

Congratulations on your purchase, and welcome to the "family!"

Dear PHILIPS product owner:

Thank you for your confidence in PHILIPS. You've selected one of the best-built, best-backed products available today. And we'll do everything in our power to keep you happy with your purchase for many years to come.

As a member of the PHILIPS "family," you're entitled to protection by one of the most comprehensive warranties and outstanding service networks in the industry.

What's more, your purchase guarantees you'll receive all the information and special offers for which you qualify, plus easy access to accessories from our convenient home shopping network.

And most importantly you can count on our uncompromising commitment to your total satisfaction.

All of this is our way of saying welcome-and thanks for investing in a PHILIPS product.

Sincerely,



Robert Minkhorst
President and Chief Executive Officer

P.S. Remember, to get the most from your PHILIPS product, you must return your Warranty Registration Card within 10 days. So please mail it to us right now!



Know these **safety** symbols



⚡ This "bolt of lightning" indicates uninsulated material within your unit may cause an electrical shock. For the safety of everyone in your household, please do not remove product covering.

⚠ The "exclamation point" calls attention to features for which you should read the enclosed literature closely to prevent operating and maintenance problems.

WARNING: TO PREVENT FIRE OR SHOCK HAZARD, DO NOT EXPOSE THIS EQUIPMENT TO RAIN OR MOISTURE.

CAUTION: To prevent electric shock, match wide blade of plug to wide slot, fully insert.

ATTENTION: Pour éviter les choc électriques, introduire la lame la plus large de la fiche dans la borne correspondante de la prise et pousser jusqu'au fond.

For Customer Use

Enter below the Serial No. which is located on the rear of the cabinet. Retain this information for future reference.

Model No. _____
Serial No. _____



PHILIPS

Visit our World Wide Web Site at <http://www.philips.com>

Safety Precautions

Warning: To prevent fire or shock hazard, do not expose this equipment to rain or moisture.

Federal Communications Commission (FCC) Warning: Any unauthorized changes or modifications to this equipment void the user's authority to operate it. This device meets the 21 CFR 1040.10 requirement.

Laser Safety

This unit employs a laser. Only a qualified service person should remove the cover or attempt to service this device, due to possible eye injury.

CAUTION: USE OF CONTROLS OR ADJUSTMENTS OR PERFORMANCE OF PROCEDURES OTHER THAN THOSE SPECIFIED HEREIN MAY RESULT IN HAZARDOUS RADIATION EXPOSURE.

CAUTION: VISIBLE AND INVISIBLE LASER RADIATION WHEN OPEN AND INTERLOCK DEFEATED. DO NOT STARE INTO BEAM. THE BEAM IS LOCATED INSIDE, NEAR THE DECK MECHANISM.

Special Information for Canadian Users

This Class B digital apparatus complies with Canadian ICES-003.
Cet appareil numérique de la classe B est conforme à la norme NMB-003 du Canada.

Radio/TV Interference

This equipment has been tested and found to comply with the limits for a Class B digital device, pursuant to Part 15 of the FCC Rules. These limits are designed to provide reasonable protection against harmful interference in a residential installation. This equipment generates, uses, and can radiate radio frequency energy and, if not installed and used in accordance with the instructions, may cause harmful interference to radio communications. However, there is no guarantee that interference will not occur in a particular installation. If this equipment does cause harmful interference to radio or television reception, which can be determined by turning the equipment off and on, the user is encouraged to try to correct the interference by one or more of the following measures:

- 1) Reorient or relocate the receiving antenna.
- 2) Increase the separation between the equipment and the receiver.
- 3) Connect the equipment into an outlet on a circuit different from that to which the receiver is connected.
- 4) Consult the dealer or an experienced radio/TV technician for help.

Copyright Protection

Unauthorized copying, broadcasting, public performance and lending of Discs are prohibited.

This product incorporates copyright protection technology that is protected by method claims of certain U.S. patents and other intellectual property rights owned by Macrovision Corporation and other rights owners.

Use of this copyright protection technology must be authorized by Macrovision Corporation and is intended for home and other limited viewing uses only unless otherwise authorized by Macrovision Corporation. Reverse engineering or disassembly is prohibited.

Manufactured under license from Dolby Laboratories. "Dolby" and the double-D symbol are trademarks of Dolby Laboratories. Confidential Unpublished Works. (© 1992-1997 Dolby Laboratories, Inc. All rights reserved.)

DTS is a trademark of Digital Theater Systems Inc. in the United States of America.

Copyright 2000 Philips Consumer Electronics Company. All rights reserved.

4 Table of Contents

General Information

Safety Information.....	3
Table of Contents.....	4
Introduction.....	5
Playable Discs.....	6
Hooking Up the TV/DVD.....	7-8
Optional Connections.....	9-10
Remote Control.....	11-14
Front Panel.....	15
Rear Panel.....	16

TV Setup and Features

Turning on the TV/DVD (TV mode).....	17
Language Selection (TV mode).....	18
Setting Up TV Channels.....	19
Adding or Deleting Channels.....	20
Watching a TV Program.....	21
Closed Captioning (TV mode).....	22
Picture Adjustment.....	23
V-Chip Setup.....	24-26
Sleep Timer.....	27

Disc Playback and Features

Playing a Disc.....	28
Disc Menus.....	29
Pausing Playback.....	30
Step by Step Playback/Slow Motion.....	31
Fast Forward/Reverse Search.....	32
Track Playback.....	33
Title/Chapter Playback.....	34
Specific Time Playback.....	35
Repeat Playback.....	36
A-B Repeat Playback.....	37
Programmed Playback.....	38
Random Playback.....	39
Audio Language/Sound Mode.....	40
Subtitle Language.....	41
Camera Angles.....	42
Parental Lock Password.....	43
Parental Lock Levels.....	44

DVD Player Setup and Features

Status Display.....	45
Audio Settings.....	46-47
Language Settings.....	48-50
Video Settings.....	51
Other Menu Settings.....	52

Information You May Need

Care and Maintenance.....	53
Helpful Hints.....	54-55
Glossary.....	56
Specifications.....	57
Limited Warranty.....	58
Index.....	59
Accessories.....	60

Welcome!

This Combination TV and Digital Video Disc Player (TV/DVD) will provide a quality picture and clear sound, along with endless playback features available on Digital Video Discs (DVDs). Expanding technology allows you to add options to your viewing - watch a director's cut of a movie, listen to the producer's comments, or play your favorite scene over and over again. Hear a movie in different languages, or listen only to the soundtrack. The possibilities are limited only by your choices and the materials available on the DVD.

Of course, you can listen to your favorite Audio Compact Discs (CDs) on this TV/DVD as well. Determine the order in which you want to hear the songs, or play the Disc repeatedly - all while seeing the status of the CD on your TV/DVD. We hope you enjoy this TV/DVD and learn to use all of its features. To get the most out of the TV/DVD, read this owner's manual carefully. It will describe how you can access all the features listed below.

DVD Player Features

- Audio Language/Sound Mode Choices*
- Automatic Detection of Disc Type (Audio CD or DVD)
- Dolby Digital Sound
- DVD Menus in a Desired Language*
- Multiple Camera Angles*
- On-Screen Display
- Parental Lock*
- Paused/Fast/Slow/Step-by-Step Playback
- Program Playback (Audio CD only)
- Random Playback (Audio CD only)
- Screen Saver
- Subtitles in a Desired Language*
- TruSurround™

TV Features

- Closed Captioning
- On-screen menus in English, French, and Spanish
- Remote Control
- Sleep Timer
- V-Chip technology, which allows you to limit your child's TV viewing

* If available on the Disc

When referring to this manual, remember...

DVD Indicates that the feature described is available on some Digital Video Discs.

AUDIO CD Indicates that the feature described is available on some Audio Compact Discs.

Disc Menus...

Some explanations in this manual are intended to describe the Disc Menus. These menus are set by the movie producers or by the music industry, and the menus will vary among Discs. Furthermore, not all Discs are guaranteed to have menus. However, if the Disc has a menu, you can access the Disc Menu by pressing the DVD button, then pressing the MENU button on the remote control.

TV/DVD Menus...

Some instructions explain how to use the TV/DVD's menus to set up features of the TV/DVD or the Disc. *Remember, there is a menu for features of the TV and there is a menu for the features of the DVD Player. To access the TV menu, press the TV button, then press the MENU button. To see the DVD Player menu, press the DVD button, then press the SETUP button.* Even if a feature is set up in the TV/DVD's menus, it may not be available if the current Disc does not include that feature.





Available Disc Features...

Not all of the features described in this manual are available on every DVD or Audio CD. If the feature is not available on the Disc, you cannot use the TV/DVD to make these features available. The "No feature" symbol will appear on the TV screen if you try to set up a feature that is not available on the current Disc or not available at the current time.

6 Playable Discs

This TV/DVD will play Digital Video Discs (DVDs) and Audio CDs. In order to play a DVD or Audio CD on this TV/DVD, make sure the Disc meets the requirements for Region Codes and Color Systems as described on this page. Also, the Discs should be labelled with the following logos and should meet these standards.

Disc Type	Logo	Contents	Disc Size	Maximum Playback Time	Disc Segments
Digital Video Disc		Sound and Pictures	12 cm	Approx. 4 hours (single-sided) Approx. 8 hours (double-sided)	DVDs are divided into Titles, which are divided into Chapters. Titles and Chapters are numbered.
			8 cm	Approx. 80 minutes (single-sided) Approx. 160 minutes (double-sided)	
Audio CD		Sound	12 cm	74 minutes	Audio CDs are divided into numbered Tracks, i.e., a track may be one song.
			8 cm (singles)	20 minutes	

Region Codes

DVDs also must be labelled for ALL regions or for Region 1 in order to be played in this TV/DVD. You can not play Discs that are labelled for other regions. Look for the symbols below on your DVDs. If these region symbols do not appear on your DVD, you cannot play the DVD in this TV/DVD.



The number inside the globe refers to a region of the world. Region 1 represents the United States, Canada, upper regions of North America, Bermuda, the U.S. Virgin Islands, and small regions near Australia.

A Disc encoded in a specific region format can only be played on DVD Players with the same region code. For example, if a Disc is labelled for Region 2, you can not play the DVD on this TV/DVD.

Color Systems

Different color systems are available throughout the world. The most common color systems are NTSC, which is used primarily in the United States and North America, PAL, and SECAM.

This TV/DVD uses the NTSC color system. Therefore, the Discs that you play must be recorded in the NTSC system. You cannot play Discs recorded in other formats. The color system of the DVD may be listed on the DVD or on the Disc jacket.

Unacceptable Discs

The following Discs cannot be played on this TV/DVD.

- CD-ROM
- Compact Disc-Interactive (CD-I)
- Compact Disc-Recordable (CD-R)
- Digital Video Disc-Video Recordable (DVD-VR)
- DVD-RAM
- DVD-ROM
- DVD-RW
- DVD+RW
- Photo CD
- Video CD
- Video Single Disc (VSD)

The following discs may be played, but only the audio will be available. There will be no picture.

- Compact Disc-Graphic (CD-G)
- Compact Disc-Video (CD-V)

1

Disconnect all equipment from the power sources before changing any connections. If you are connecting other equipment, such as a VCR or a stereo, to the TV/DVD, read the owner's manuals of the other equipment as well. You may need to refer to pages 9-10 of this manual, too.

2

Hook up your TV/DVD using one of the connections shown (2A-2D).

2A.

Hooking Up Your TV/DVD with a Cable Signal or Outdoor Antenna

Connect a Cable signal or an antenna to the ANT(enna) Jack.

Note to Cable TV (CATV) System Installer:

This reminder is provided to call the CATV system installer's attention to Article 820-40 of the NEC that provides guidelines for proper grounding and, in particular, specifies that the cable ground shall be connected to the grounding system of the building as close to the point of cable entry as practical.

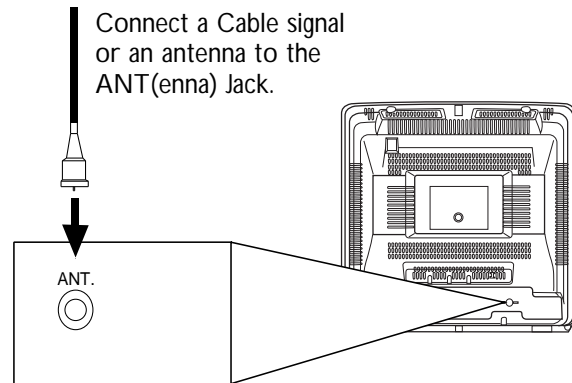

2B.

Hooking Up Your TV/DVD with a Cable Box

Connect the Cable signal to the IN Jack on the Cable Box.

Connect an RF coaxial cable to the OUT Jack on the Cable Box and to the ANT(enna) Jack on the TV/DVD.

To view any channel, set the TV/DVD to the Cable Box output channel (channel 03 or 04) while in TV mode. Then, select channels at the Cable Box.

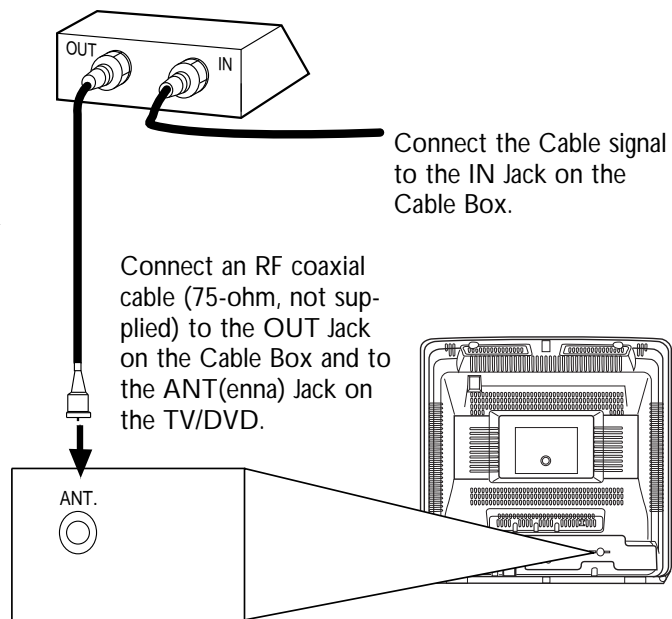

Instructions continue on page eight.

8 Hooking Up the TV/DVD (cont'd)

2C.

Hooking Up Your TV/DVD with an Indoor Rod Antenna or a Combined UHF/VHF Antenna

Push the stem of the antenna into the antenna hole on the top of the TV/DVD. Connect the antenna wire to the ANT(enna) Jack on the back of the TV/DVD.

Extend the rod antenna and adjust its length, direction, and angle for the clearest picture.

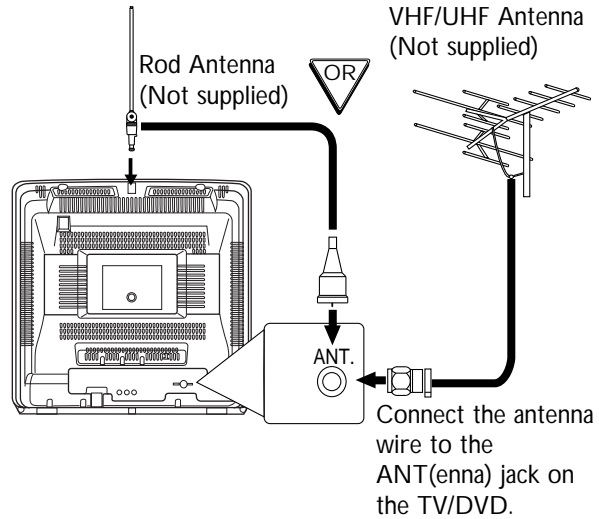

2D.

Hooking Up Your TV/DVD to Another Video Source (VCR or Camcorder)

You may need this connection if you want to view videotapes on the TV/DVD.

When viewing material from other equipment, press the SELECT button repeatedly until VIDEO appears in the top right corner of the TV/DVD screen. That indicates that the TV/DVD is in VIDEO mode and is receiving the programming from the equipment that is connected to the AUDIO and VIDEO In jacks on the front of the TV/DVD.

- If the VCR or camcorder only has one audio out jack, use the white audio cable to connect it to the white AUDIO L (left) In jack on the front of the TV/DVD.

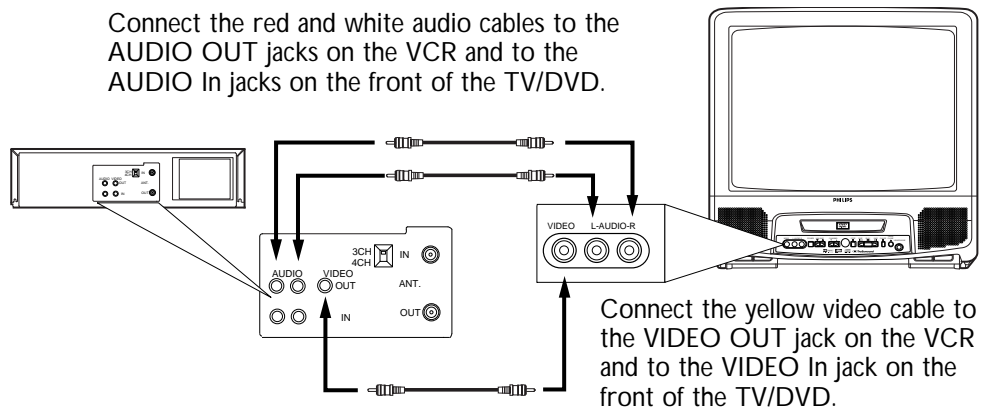

3

Unless you want to connect the TV/DVD to a stereo or decoder, you are finished. Connect the TV/DVD (and Cable Box, VCR, etc.) to a power source. Go to page 11 to set up your remote control, then go to page 17 to turn on the TV/DVD. To connect more equipment to your TV/DVD, refer to pages 9-10.

Optional Connections 9

Connecting to a Stereo

1

Complete the antenna/cable connections as described on pages seven-eight.

2

Connect red and white audio cables to the red and white AUDIO OUT jacks on the back of the TV/DVD and to the AUDIO IN jacks on the stereo.

3

Set your stereo to **Auxiliary In**. See your stereo owner's manual for details.

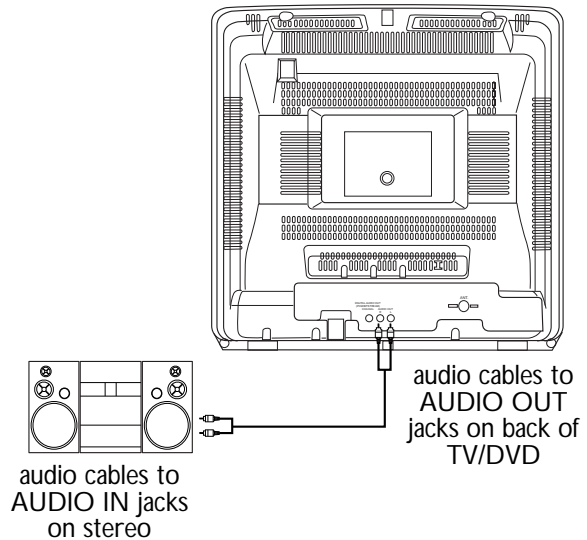

Connecting to an Amplifier Equipped with Digital Input Jacks, MD Deck or DAT Deck

1

Complete the antenna/cable connections as described on pages seven-eight.

2

Connect an audio coaxial digital cable (not supplied) to the DIGITAL AUDIO OUT (PCM/BITSTREAM) COAXIAL jack on the back of the TV/DVD and to the COAXIAL DIGITAL AUDIO IN jack on the amplifier.

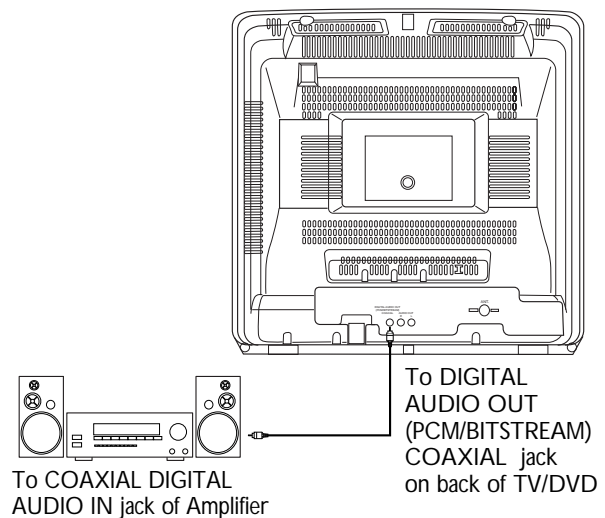

Helpful Hints

- A 5.1 channel Dolby Digital surround disc cannot be rerecorded or copied digitally by an MD or DAT deck.
- Set Dolby Digital and DTS to OFF. Details are on pages 46-47.

10 Optional Connections (cont'd)

Connecting to a Dolby Digital Decoder or DTS Decoder

If you connect the TV/DVD to a Dolby Digital or DTS decoder, you can enjoy a more realistic, high-quality sound when playing Discs recorded in 5.1 channel Dolby Digital Surround or DTS Surround Sound formats.

To COAXIAL DIGITAL
AUDIO IN jack of Decoder

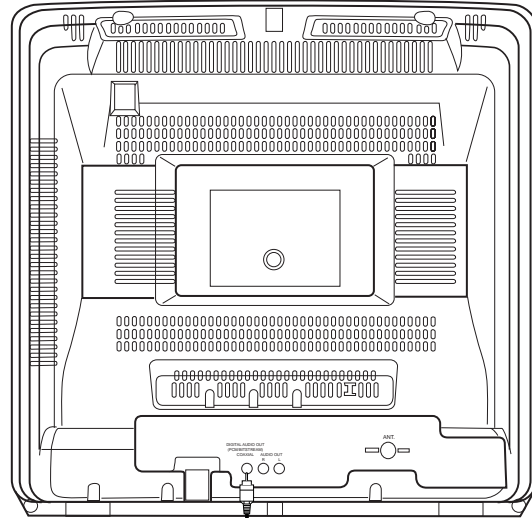
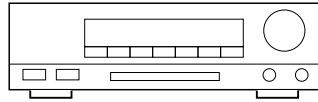

To DIGITAL
AUDIO OUT
(PCM/BITSTREAM)
COAXIAL jack
on back of TV/DVD

1

Complete the antenna/cable connections as described on pages seven-eight.

2

Connect an audio coaxial digital cable (not supplied) to the DIGITAL AUDIO OUT (PCM/BITSTREAM) COAXIAL jack on the back of the TV/DVD and to the COAXIAL DIGITAL AUDIO IN jack on the decoder.

3

- If the TV/DVD is connected to a Dolby Digital decoder, set DOLBY DIGITAL to ON. *Details are on pages 46-47.*
- If the TV/DVD is connected to a DTS decoder, set DTS to ON. *Details are on pages 46-47.*
- If the TV/DVD is not connected to a Dolby Digital decoder or a DTS decoder, set DOLBY DIGITAL and DTS to OFF. *Details are on pages 46-47.* Using incorrect settings may cause noise distortion and damage the speakers.

Manufactured under license from Dolby Laboratories. "Dolby" and the double-D symbol are trademarks of Dolby Laboratories. Confidential Unpublished Works. ©1992-1997 Dolby Laboratories, Inc. All rights reserved.
"DTS" and "DTS Digital Out" are trademarks of Digital Theater Systems, Inc.

Remote Control 11

Putting Batteries in the Remote Control

1

Remove the battery compartment lid on the bottom of the remote control by pressing the tab, then lifting the lid.

2

Place two AA batteries inside the battery compartment with their + and – ends aligned as indicated.

3

Replace the battery compartment lid.

Using the Remote Control

- Point the remote control at the TV/DVD's remote sensor (see page 15) when using the remote control to operate the TV/DVD.
- Do not put objects between the remote control and the TV/DVD.

Recycling Guidelines/Battery Safety

Your new product and its packaging contain materials that can be recycled and reused. Specialized companies can recycle your product to increase the amount that needs to be properly disposed.

Your product uses batteries that should not be thrown away when depleted but should be disposed of as small chemical waste. Please find out about the local regulations on disposal of your old product, batteries, and packaging whenever you replace existing equipment.

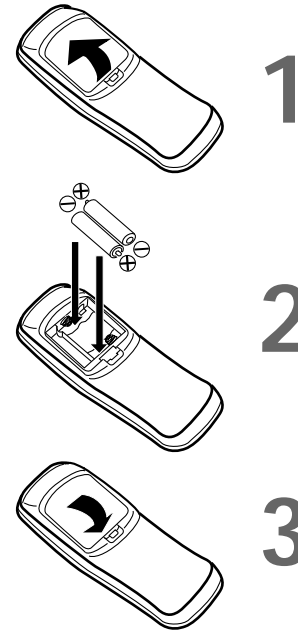

Helpful Hints

- The remote control and its batteries are supplied.
- Do not mix alkaline and manganese batteries.
- Do not mix old and new batteries.

12 Remote Control (cont'd)

SELECT Button

Press to select TV, VIDEO, or DVD mode. TV (or the current TV channel), VIDEO, or DVD will appear in the top right corner of the screen to show the current mode of the TV/DVD.

POWER Button

Press to turn the power on and off.

SLEEP Button

Press the SLEEP button repeatedly to set the Sleep Timer. (You can not set the Sleep Timer while in DVD mode.) *Details are on page 27.*

TV Button

Press this button first when using the remote control to operate a TV feature.

Number Buttons

• TV mode

Press the TV button before using the Number buttons to select a TV channel. Select channels 1-99 as a two-digit channel. For example, to select channel six, press the TV button, then press Number buttons 0,6.

To select channels 100 and above, press the +10/+100 button, then press the last two digits of the channel. For example, to select channel 115, press the TV button, then the +10/+100 button, then Number buttons 1, 5. If you only press a single number button, the TV channel will not change.

• DVD mode

Press the DVD button, then press the Number buttons to select a Track (Audio CD) or a Chapter or Title (DVD) for playback. *Details are on pages 33-34.* For single-digit Tracks, press a single number button.

For example, to play Track three, press the Number 3 button. For Tracks numbered 10 and above, press the +10/+100 button as often as needed, then press the Number button of the second digit. For example, to play Track 12, press the +10/+100 button once, then press the Number 2 button. For Track 22, press the +10/+100 button twice, then press the Number 2 button.

Use the Number buttons to program Tracks (Audio CD) for playback.

Details are on page 38.

SETUP Button

When Disc playback is stopped and the TV/DVD is in DVD mode, press the DVD button, then press the SETUP button to access or remove the menu of the DVD Player. The DVD Player menu lets you set up features for DVD mode. *Details are on pages 43-52.*

MODE Button

Press the DVD button, then press the MODE button to set up programmed or random playback for an Audio CD.

Details are on pages 38-39.

AUDIO Button

Press the DVD button, then press the AUDIO button, then press the ▲ or ▼ button to choose one of the audio languages or sound modes available on the Disc. *Details are on page 40.*

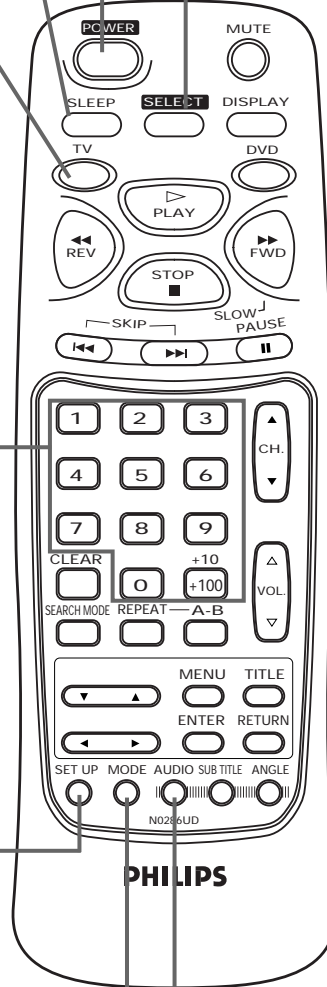

Remote Control (cont'd) 13

PAUSE Button

Press the DVD button, then press the PAUSE button to pause Disc playback. *Details are on page 30.* Press the PAUSE button repeatedly to advance the DVD picture step by step (or one frame at a time). *Details are on page 31.*

MUTE Button

Press the MUTE button to turn off the sound. Press the MUTE button again or press the VOL(ume) ▲/▼ button to restore the sound. The volume indicator will turn purple and will remain on the screen as long as the sound is muted. (The volume indicator will disappear if closed captioning is active. *Details are on page 22.*)

PLAY Button

Press to begin Disc play. *Details are on page 28.*

REV (reverse) ◀◀ Button

Press to view the picture in fast reverse motion (DVD) or to reverse playback of an Audio CD. *Details are on page 32.*

STOP Button

Press to stop Disc play.

SLOW/FWD (forward) ▶▶ Button

Press to fast forward the Disc. *Details are on page 32.*
During DVD playback, press the DVD button, then press the PAUSE button, then press the SLOW/FWD button to begin slow motion playback. Press the SLOW/FWD button repeatedly to change the forward speed of slow motion. *Details are on page 31.*

REPEAT Button

Press the DVD button, then press the REPEAT button to repeat playback of the current Disc or Track (Audio CD) or a Title or Chapter (DVD). *Details are on page 36.*

A-B REPEAT Button

Press the DVD button, then press the A-B REPEAT button to set up A-B Repeat Play, which repeatedly plays a specific segment of a Disc. *Details are on page 37.*

MENU Button

In TV mode, press the TV button, then press the MENU button to access or remove the TV menu. Press the ▲ or ▼ button to select an item in the menu. Press the ▶ or ◀ button to adjust an item in the menu or to advance to the next menu.
In DVD mode, press the DVD button, then press the MENU button to display the menu of the Disc. *Details are on pages 5 and 29.*

RETURN Button

In DVD mode only, press the DVD button, then press the RETURN button to return to the previous DVD Player SETUP menu or to remove the SETUP menu from the screen.

TITLE Button

Press the DVD button, then press the TITLE button to display the Title menu of the Disc, if available. *Details are on page 29.*

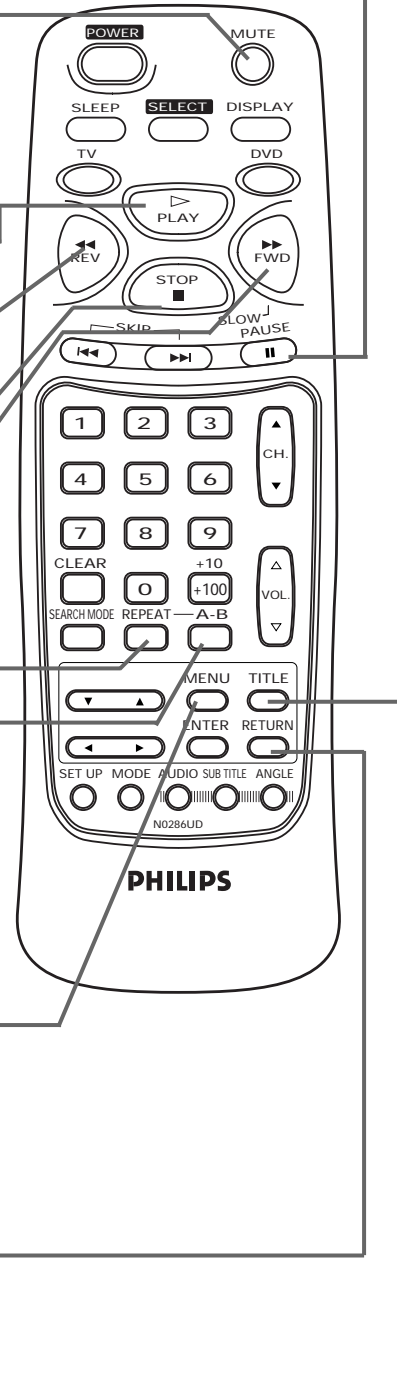

14 Remote Control (cont'd)

DISPLAY Button
In TV mode, press the TV button, then press the DISPLAY button to see the current TV channel number. Press again to remove the display. In DVD mode, press the DVD button, then press the DISPLAY button to display the current status of the Disc during playback. Press repeatedly to remove the status display. *Details are on page 45.*

DVD Button
Press before using the remote control for DVD features.

SKIP Buttons
Press the DVD button, then press the SKIP buttons to skip Chapters or Tracks. *Details are on page 33.*

CH. (Channel) ▲ / ▼ Button
Press to scan through the available TV channels.

VOL. (Volume) ▲ / ▼ Button
Press to increase or decrease the volume.

CLEAR Button
Press to remove Track numbers from a Program. *Details are on page 38.*

SEARCH MODE Button
Press the DVD button, then press the SEARCH MODE button to access or remove the SEARCH menu, which allows you to go directly to a specific Title/Chapter/Track/Time. *Details are on pages 33-35.*

ARROW Buttons
In TV mode, press the ▲ or ▼ button to select an item in the TV menu. Press the ► or ◀ button to adjust an item in the TV menu or to advance to the next TV menu. In DVD mode, press to select an item in the DVD Player SETUP menu or in the Disc menu.

ENTER Button
In DVD mode, press to select an item in the DVD Player menu or to select an item in the Disc menu.

SUBTITLE Button
Press the DVD button, then press the SUBTITLE button to access the subtitle menu. Press the ▲ or ▼ button to select a language for the subtitles (among those available) or to turn off the subtitles. *Details are on page 41.*

ANGLE Button
Press the DVD button, then press the ANGLE button to view the picture from a different angle (if available). Press the ▲ or ▼ buttons to choose one of the available angles. *Details are on page 42.*

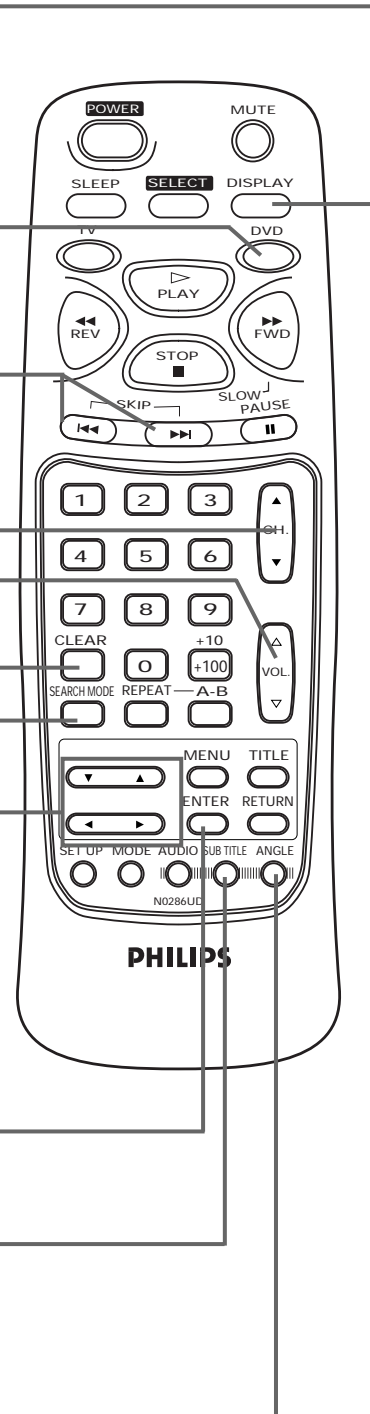

Front Panel 15

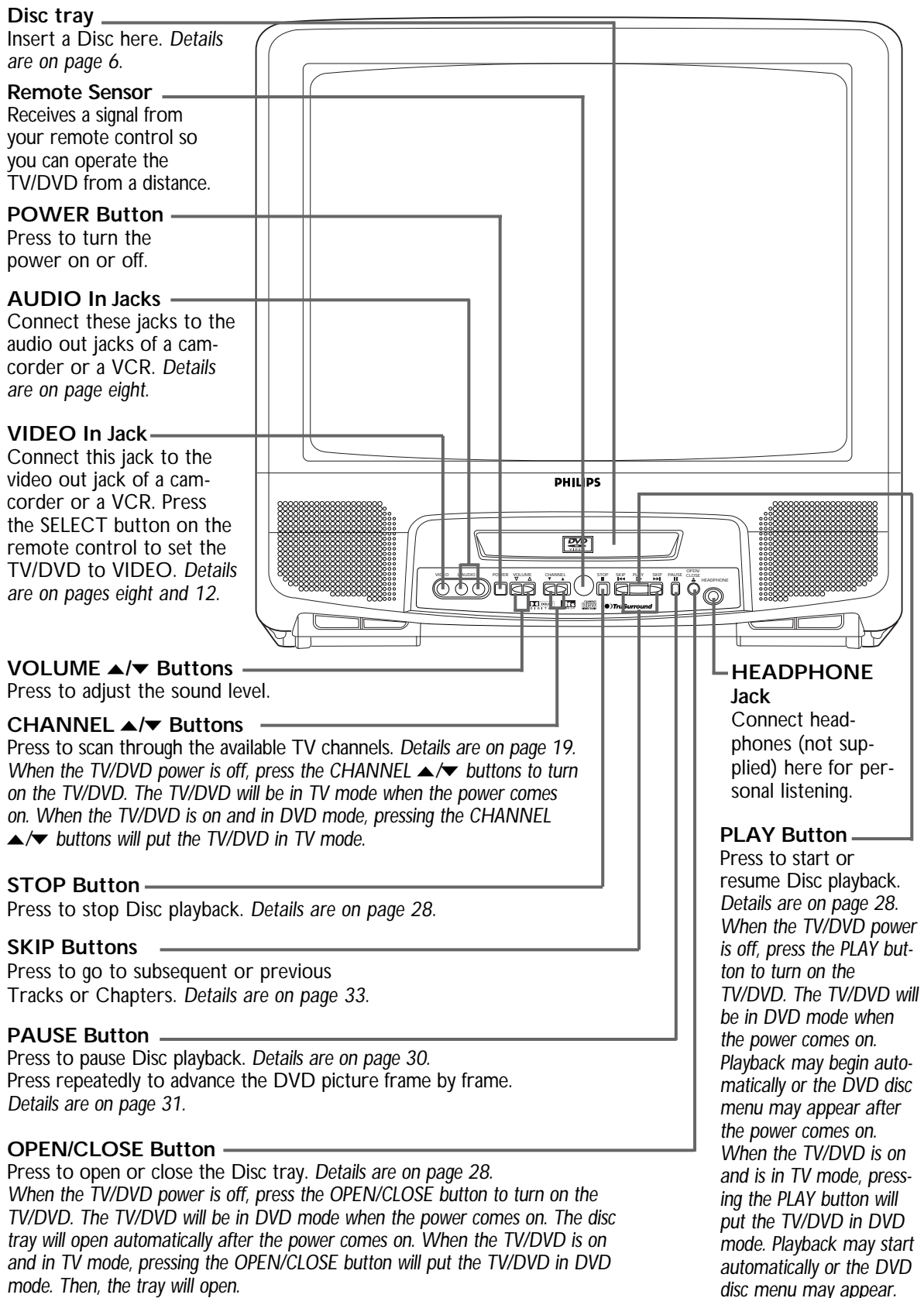

16 Rear Panel

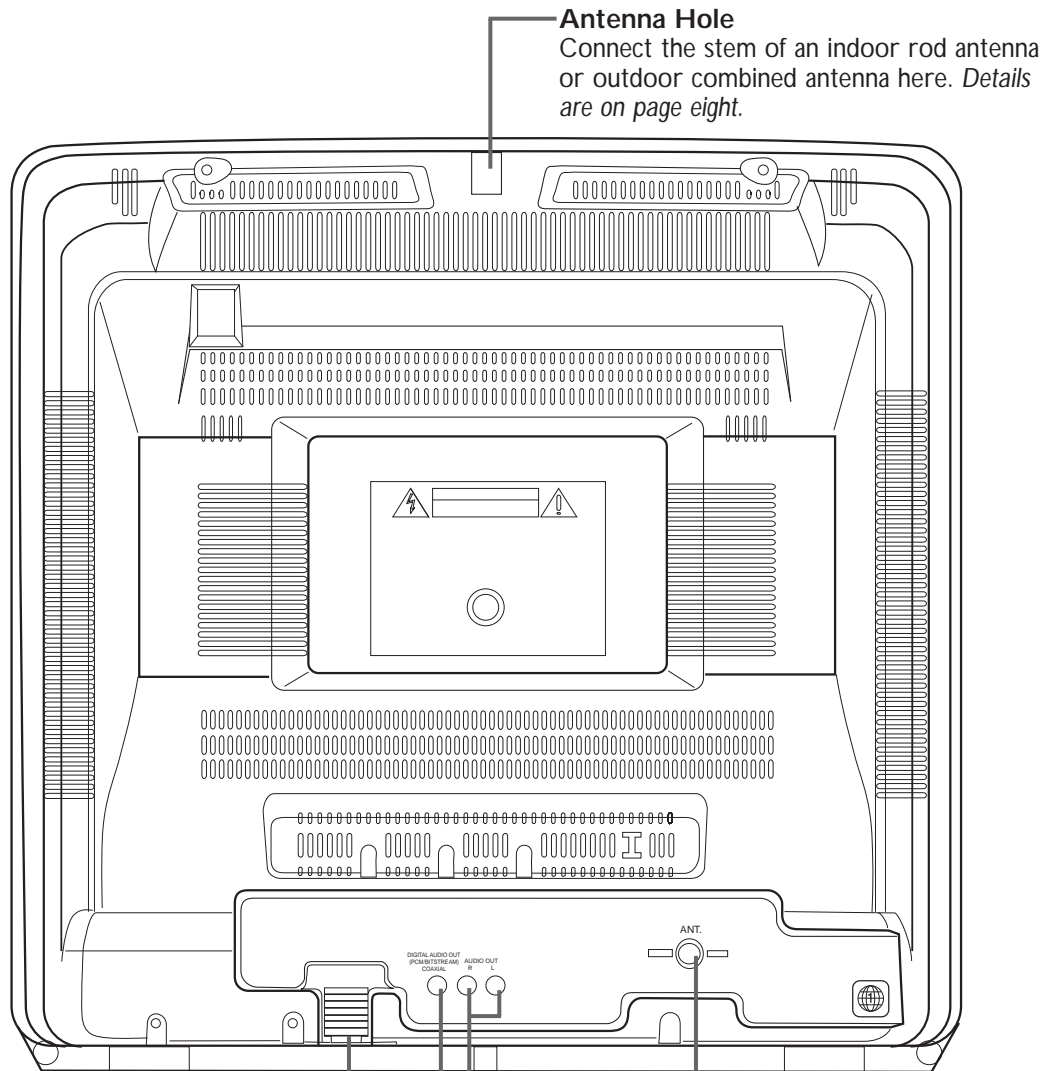

Antenna Hole

Connect the stem of an indoor rod antenna or outdoor combined antenna here. *Details are on page eight.*

AC Power Cord

Connect to a standard AC outlet to supply power to the TV/DVD.

DIGITAL AUDIO OUT (PCM/BITSTREAM) COAXIAL Jack

Connect an optional audio coaxial digital cable here and to the coaxial digital Audio In jack of a decoder or amplifier. *Details are on pages 9-10.*

AUDIO OUT Jacks

Connect audio cables here and to the Audio In jacks of a television or stereo. *Details are on page nine.* Connect the red cable to the red jack and the white cable to the white jack.

ANT (Antenna In) Jack

Connect an antenna, cable TV signal, or satellite system signal here. *Details are on pages seven-eight.*

Turning on the TV/DVD (TV mode) 17

1

Connect the power cord to a standard AC outlet.

If some digits appear on the screen, press the POWER button to turn off the TV/DVD, then go to step 2 to turn on the TV/DVD again. (You do not need to unplug the power cord.)

2

Press the POWER button to turn on the TV/DVD.

3

The TV/DVD is shipped in TV mode. If necessary, press the SELECT button on the remote control until a channel number or "TV" appears in the top right corner of the TV screen.

4

Press the TV button before pressing other TV feature buttons.

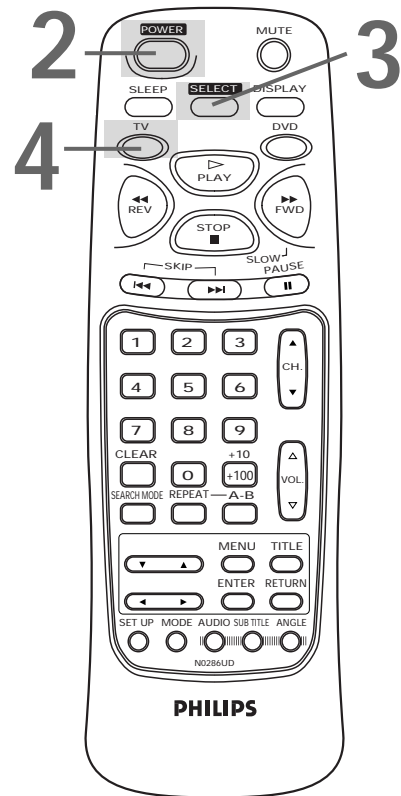

Helpful Hint

- When the TV/DVD changes to TV mode, there may be a delay of several seconds. Likewise, TV programming may be delayed for a few seconds when the TV/DVD changes to TV mode.

18 Language Selection (TV mode)

If you want to change the language of the TV menu, follow the steps below. This will not affect the language of the DVD Player menus or Disc menus.

1

In TV mode, press the TV button, then press the MENU button so that the TV menu appears on the screen.

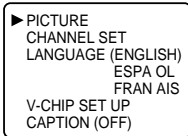

2

Press the ▲ or ▼ button to select LANGUAGE.

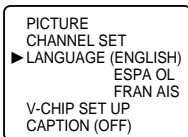

3

Press the ► or ◀ button to select ENGLISH, ESPAÑOL (Spanish), or FRANÇAIS (French). The selected language will appear inside the parentheses.

4

Press the MENU button.

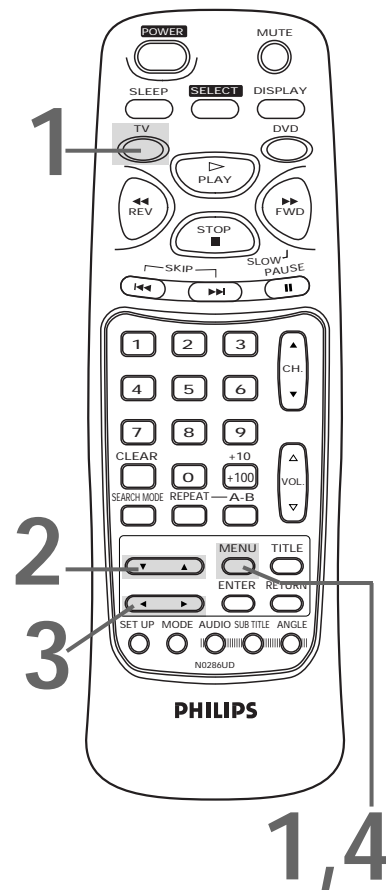

Setting Up TV Channels 19

To place your local channels into the TV/DVD memory, follow the steps below. After the available channels are memorized, only these channels will be selected when you use the CHANNEL ▲/▼ or CH. (channel) ▲/▼ buttons.

1

Press the TV button, then press the MENU button so that the TV menu appears on the screen.

▶ PICTURE
CHANNEL SET
LANGUAGE (ENGLISH)
ESPA OL
FRAN AIS
V-CHIP SET UP
CAPTION (OFF)

2

Press the ▲ or ▼ button to select CHANNEL SET. Then, press the ► button.

▶ ADD/DELETE
AUTO MEMO

3

Press the ▲ or ▼ button to select AUTO MEMO. Then, press the ► button.

The TV/DVD scans and memorizes all the active channels in your area. Channel numbers will appear on the screen briefly during the scanning.

- The TV automatically distinguishes between standard TV channels and cable channels.
- When scanning is complete, programming of the lowest memorized channel will appear on the screen.

▶ ADD/DELETE
AUTO MEMO

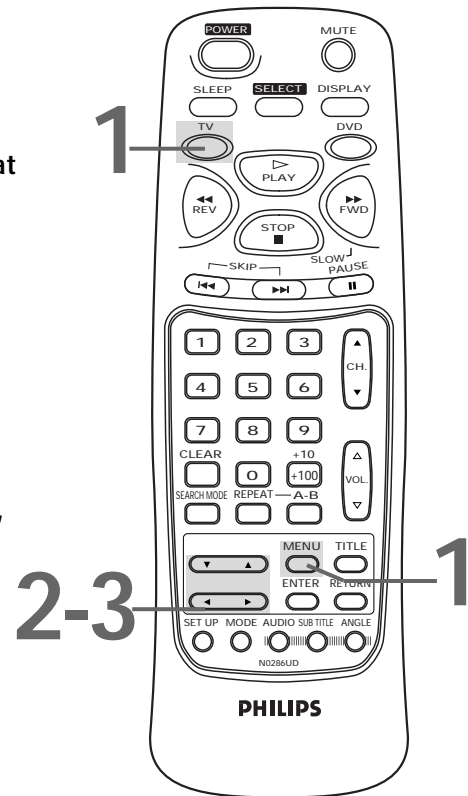

20 Adding or Deleting Channels

1

Press the TV button, then press the MENU button so that the TV menu appears on the screen.

2

Press the ▲ or ▼ button to select CHANNEL SET. Then, press the ► button.

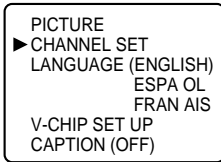

3

Press the ▲ or ▼ button to select ADD/DELETE. Then, press the ► button.

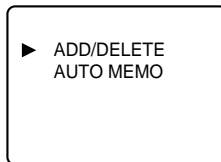

4

Within 10 seconds, press the CH. (Channel) ▲/▼ button to select the channel you want to add or delete.

5

Within 10 seconds of selecting a channel, press the ► or ◀ button so that the channel number changes to teal or purple. Make the channel number teal if you wish to add the channel into memory. Make the channel number purple if you wish to delete the channel from memory.

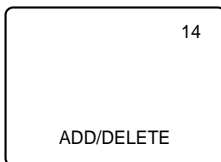

6

Repeat steps 4-5 to add or delete other channels.

After you add or delete the last channel, the information will disappear from the screen after about 10 seconds if no other buttons are pressed. Or, press the MENU button to remove the menu.

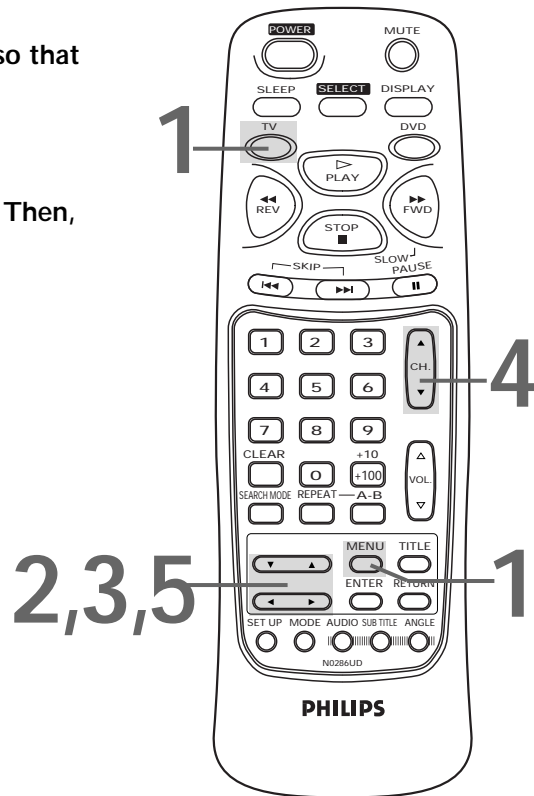

Helpful Hint

- You can still select channels using the Number buttons, even if the channel is not memorized. Only memorized channels will be available when you use the CH. (Channel) ▲/▼ button.

Watching a TV Program 21

1

Press the POWER button to turn on the TV/DVD.

2

Press the SELECT button repeatedly so that TV or a channel number appears in the upper right corner of the screen.

3

Press the TV button.

4

Press the CH. (Channel) ▲/▼ button or the Number buttons to select a TV channel.

5

Press the VOL. (Volume) ▲/▼ button to adjust the volume.

6

Adjust the picture controls for a natural image.

Details are on page 23.

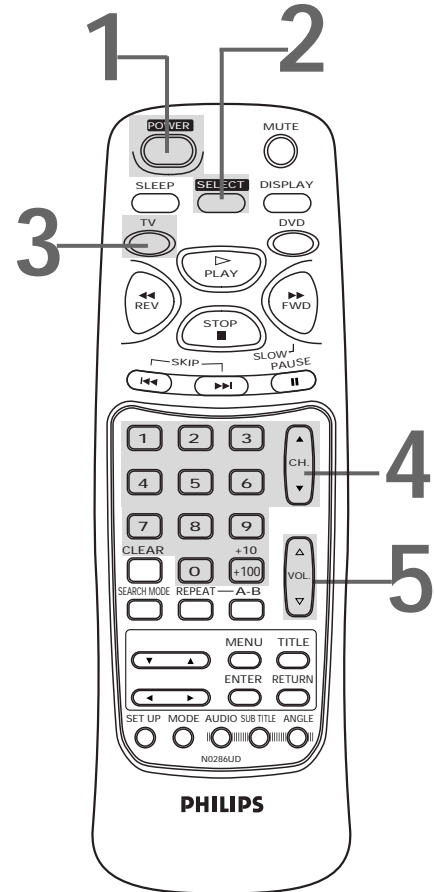

Helpful Hint

- When the TV/DVD power is off, press the CHANNEL ▲/▼ buttons on the front of the TV/DVD to turn on the TV/DVD. The TV/DVD will be in TV mode when the power comes on. When the TV/DVD is in DVD mode, pressing the CHANNEL ▲/▼ buttons will put the TV/DVD in TV mode.

22 Closed Captioning (TV mode)

This TV can receive Closed Captioning as Captions and as Text. Usually C1 (Caption 1) is the preferred Closed Caption mode.

- **C1 or C2** (Caption 1 or 2): Dialogue (and descriptions) for the action on the TV program shows on the screen.
- **T1 or T2** (Text 1 or 2): A black box appears on the TV screen. If Text mode is available with the current TV program, text or information will appear.

• **CAPTION OFF**: Turns off Closed Captions completely. To select a Closed Captioning mode, follow the steps below. Remember, not all TV programs and commercials are broadcast with Closed Captioning. Neither are all Closed Caption modes used by a broadcast station during the transmission of a program. Refer to your area's TV program listings for the stations and times of shows with Closed Captioning.

1

Press the TV button, then press the MENU button so that the TV menu appears on the screen.

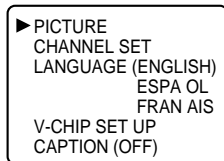

2

Press the ▲ or ▼ button to select CAPTION.

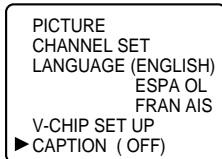

3

Press the ► or ◀ button to select C1, C2, T1, T2, or OFF.

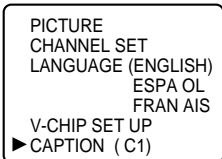

4

Press the MENU button.

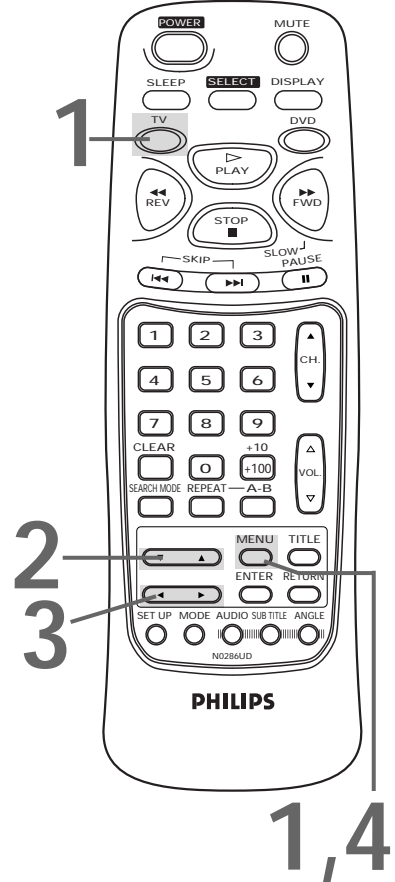

Helpful Hints

- Captions and texts may not match the TV broadcast exactly.
- Interference or a weak antenna/cable signal may cause the Closed Captioning system to function improperly.
- Closed Captioning will not appear if the menu is on the screen.
- If a black box appears on the screen, you have set CAPTION to T1 or T2. To clear the black box, select C1, C2, or OFF.
- Closed Captions may not be available or correct if you are viewing recorded material from another source. (For example, if you have connected a VCR to your TV/DVD and are viewing the tape on the TV/DVD. Details are on page eight.)

Picture Adjustment 23

1

Press the TV button, then press the MENU button so that the TV menu appears on the screen. PICTURE will be selected.

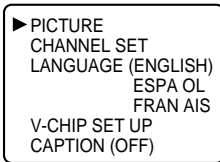

2

Press the ► button to access the PICTURE menu.

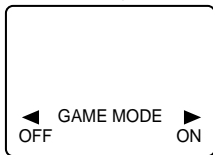

3

Within 10 seconds, press the ► or ◀ button to set GAME MODE to ON or OFF. The current setting will appear in purple. For example, if OFF is purple, GAME MODE is OFF.

4

Within 10 seconds, press the ▲ or ▼ button to select the next picture setting. You may select BRIGHT, CONTRAST, COLOR, or TINT. Use the ► or ◀ button to increase or decrease the setting.

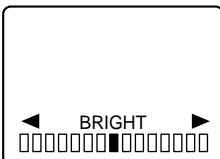

5

Repeat step 4 as often as necessary, until you have changed all the settings you wish.

	Decrease	Increase
BRIGHTNESS	decreased brightness	increased brightness
CONTRAST	decreased contrast	increased contrast
COLOR	paler	more brilliant
TINT	more purple	more green

6

The menus will disappear if no buttons are pressed for 10 seconds. Or, press the MENU button to remove the menus. The Tv picture will be determined by the last setting you adjusted.

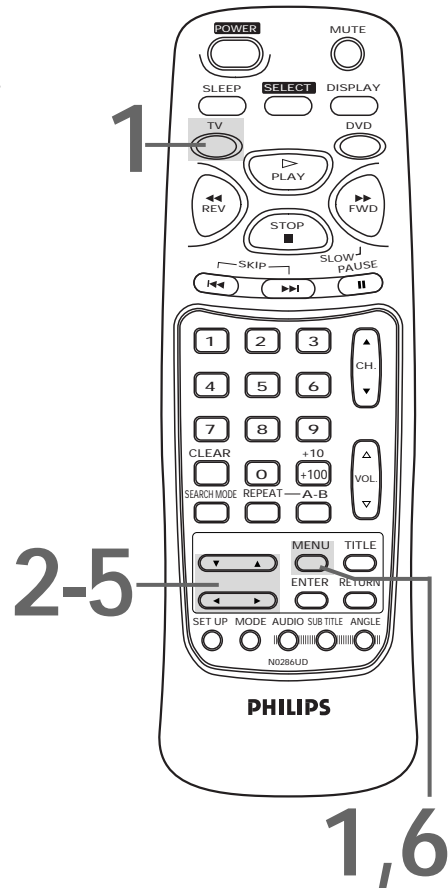

Helpful Hint

- At step 2, GAME MODE will appear on the screen the first time you access the PICTURE settings. Otherwise, the most recently selected picture setting will appear first. For example, if you last adjusted TINT, then TINT will appear first.

24 V-Chip Setup

V-Chip enables parents to prevent their children from watching inappropriate material on TV. The TV/DVD's V-Chip reads the ratings for programming (except for news and sports programs, unedited movies on premium cable channels, and Emergency Broadcast System signals), then denies access to TV programming if the program's rating meets the limitations you select. If the programming is blocked, "PROTECTED PROGRAM by ..." appears on the screen when you try to watch a TV program. You must select a different TV channel or program. Programming may be rated by the Motion Picture Association of America (MPAA) or according to the Television Parental Guidelines. In order to block any inappropriate programming, set your limits in both places (MPAA RATING and TV RATING). To set viewing limits according to the TV Parental Guideline ratings, follow the steps below. To set viewing limits according to the MPAA ratings, follow the steps on page 26. Remember, setting V-Chip limits has no effect on DVD playback. To limit viewing of DVDs, use Parental Lock. *Details are on pages 43-44.*

TV RATING

1

Press the TV button, then press the MENU button so that the TV menu appears on the screen.

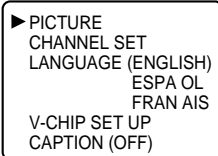

2

Press the ▲ or ▼ button to select V-CHIP SET UP.

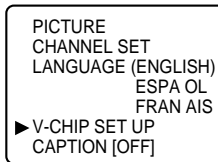

3

Press the ► button to go to the V-CHIP SET UP menu. TV RATING will be selected.

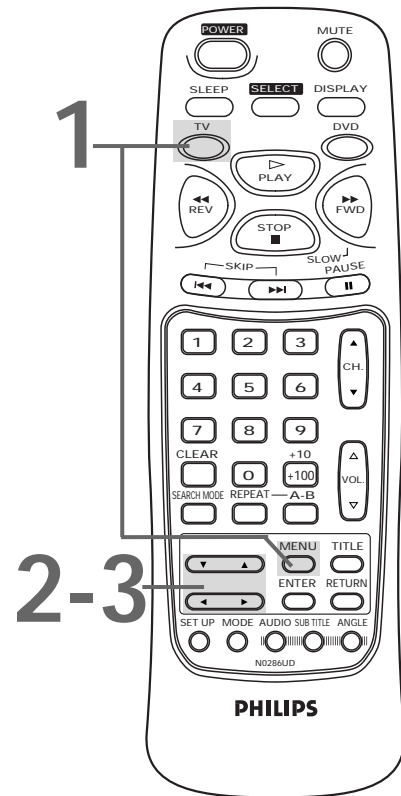
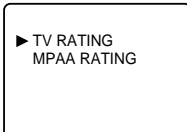

TV RATINGS

- V - Violence
- S - Sexual situations
- L - Language
- D - Inappropriate dialogue
- FV - Fantasy Violence may frighten children under seven; TV-Y7 category only. Some cartoons may have this rating.
- TV-Y - Appropriate for all children
- TV-Y7 - Appropriate for children seven and older
- TV-G - General Audience
- TV-PG - Parental Guidance suggested.
- TV-14 - Unsuitable for children under 14
- TV-MA - Mature audience only

4

Press the ► button to see the TV ratings.

►TV-Y	[VIEW]
TV-Y7 ()	[VIEW]
TV-G	[VIEW]
TV-PG ()	[VIEW]
TV-14 ()	[BLOCK]
TV-MA ()	[BLOCK]

5

Press the ▲ or ▼ button to select a rating, then press the ► button once to select BLOCK or VIEW. When you block a rating, the rating you selected, as well as all the higher ratings, will be blocked. Lower ratings will be set to VIEW automatically.

►TV-Y	[VIEW]
TV-Y7 ()	[VIEW]
TV-G	[VIEW]
TV-PG ()	[VIEW]
TV-14 ()	[VIEW]
TV-MA ()	[VIEW]

6

Additional sub-ratings are available for TV-Y7, TV-PG, TV-14, and TV-MA. If you selected TV-Y7, TV-PG, TV-14, or TV-MA at step 5, press the ► button a second time to see the sub-ratings.

TV-PG	[BLOCK]
►D	[BLOCK]
L	[BLOCK]
S	[BLOCK]
V	[BLOCK]

7

If you set the rating category to BLOCK or VIEW, the sub-ratings (for example, V for violence) will turn to BLOCK or VIEW automatically. You can set the sub-ratings to BLOCK or VIEW individually only when the rating category is set to BLOCK.

Press the ▲ or ▼ button to select either the category or a sub-rating. Then, press the ► or ◀ button to set the category or sub-rating to BLOCK or VIEW.

8

Press the MENU button.

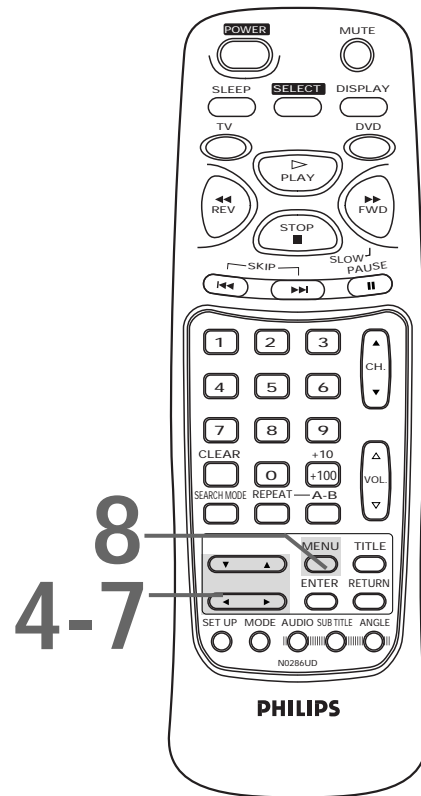

Helpful Hint

- D (inappropriate dialog) is not an available sub-rating for TV-MA.
- Sub-ratings that are blocked will appear beside the category in parentheses at the TV RATING menu (step 4).

26 V-Chip Setup (cont'd)

MPAA RATING

1

Press the TV button, then press the MENU button so that the TV menu appears on the screen.

▶ PICTURE
CHANNEL SET
LANGUAGE (ENGLISH)
ESPA OL
FRAN AIS
V-CHIP SET UP
CAPTION (OFF)

2

Press the ▲ or ▼ button to select V-CHIP SET UP. Then, press the ▶ button.

PICTURE
CHANNEL SET
LANGUAGE (ENGLISH)
ESPA OL
FRAN AIS
▶ V-CHIP SET UP
CAPTION [OFF]

3

Press the ▲ or ▼ button to select MPAA RATING. Then, press the ▶ button.

TV RATING
▶ MPAA RATING

4

Press the ▲ or ▼ button to select the rating that you want to block or view. Then, press the ▶ button to select **BLOCK** or **VIEW**. When you block a rating, the rating you selected, as well as all the higher ratings, will be blocked. Lower ratings will be set to VIEW automatically.

G	[VIEW]
PG	[VIEW]
PG-13	[VIEW]
▶ R	[BLOCK]
NC-17	[BLOCK]
X	[BLOCK]

5

Press the MENU button.

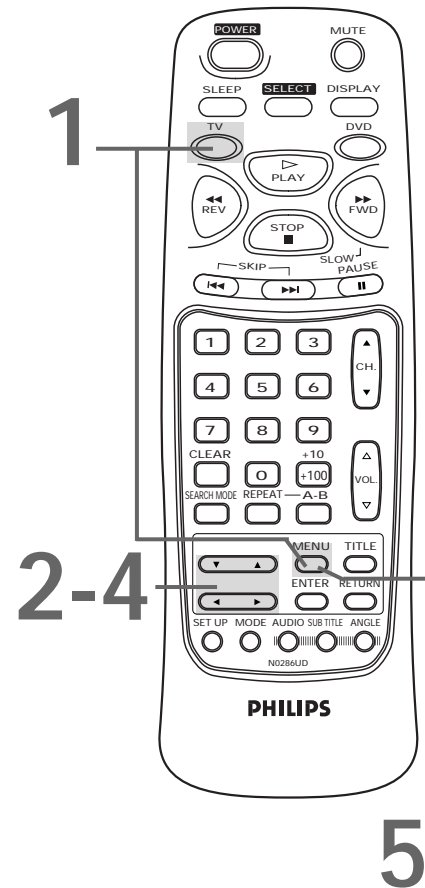

MOVIE RATINGS

- G - General Audience
- PG - Parental Guidance suggested.
- PG-13 - Unsuitable for children under 13
- R - Restricted; under 17 requires accompanying parent or adult guardian
- NC-17 - No one under 17 admitted
- X - Mature audience only

Helpful Hint

- You cannot access the TV menu when the "PROTECTED PROGRAM by..." message appears.

Sleep Timer 27

The Sleep Timer will shut off the TV/DVD automatically after the amount of time you select.

1

Press the TV button, then press the SLEEP button on the remote control repeatedly until your preferred amount of time appears at the bottom of the screen. You may set a Sleep Timer to shut off the TV/DVD in 10, 20, 30, 40, 50, 60, 70, 80, or 90 minutes.

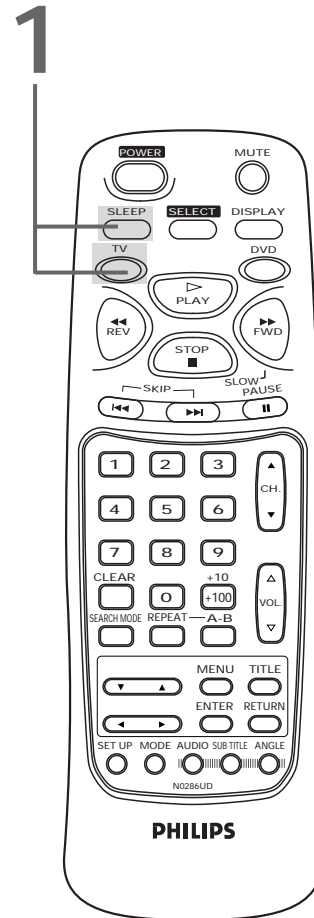

Helpful Hints

- The Sleep Timer will be cancelled if the power fails or if you turn off the TV/DVD.
- To see the amount of time remaining before the TV/DVD turns off, press the SLEEP button once.
- To cancel the Sleep Timer, press the SLEEP button repeatedly until "SLEEP 0" appears on the screen.

28 Playing a Disc

DVD

AUDIO CD

1

Press the **POWER** button to turn on the TV/DVD.

2

Press the **SELECT** button until **DVD** appears in the top right corner of the screen, then press the **DVD** button.

3

Press the **OPEN/CLOSE** button on the TV/DVD to open the Disc tray. (Please wait a few seconds for the tray to open.)

4

Place a Disc into the tray. Make sure the Disc is sitting properly in the correct recess.

Some DVDs are recorded on both sides. Make sure the side you want to play is facing up. Or, if the DVD is recorded on only one side, place the Disc in the tray with the label facing up.

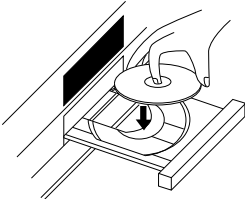

5

Press the **PLAY** button. The tray will close automatically, and playback will begin at the first Chapter or Track of the Disc. Or, you may press the **OPEN/CLOSE** button to close the tray, and DVD playback will start automatically. (You also may close the tray by gently pressing the Disc tray toward the TV/DVD.)

If the DVD in the tray has a menu, the menu may appear on the screen instead. *Details are on page 29.*

With some Audio CDs, playback will not begin until you press the **PLAY** button.

6

Press the **STOP** button to stop playback.

Remember, this TV/DVD will play only certain Discs. See page six for details.

3-4 Insert a Disc.

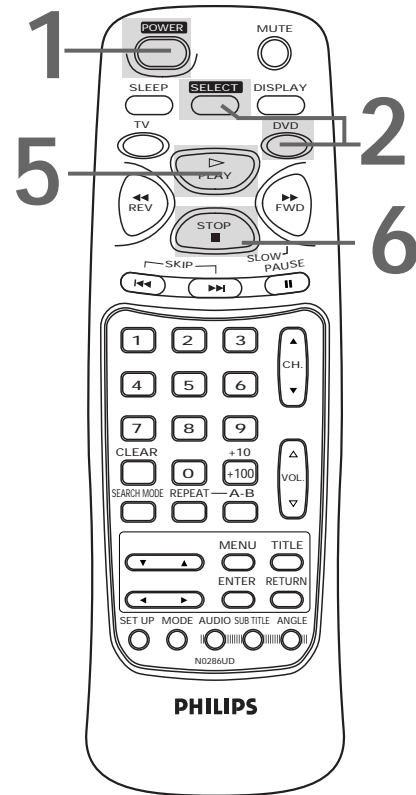

Helpful Hints

- You can turn on the TV/DVD and select DVD mode automatically by pressing the **PLAY** or **OPEN/CLOSE** button on the TV/DVD. Details are on page 15.
- A "No Feature" symbol  may appear at the bottom right of the TV screen. This symbol means either the feature you tried is not available on the Disc, or the TV/DVD can not access the feature at this time. This does not indicate a problem with the TV/DVD.
- If a Disc is dirty or has scratches, the pictures may appear distorted and playback may stop. In such cases, remove the Disc and turn off the TV/DVD. Unplug the power cord from the AC outlet, then reconnect it. Clean the Disc, then turn on the TV/DVD again and reinsert the Disc for playback.

Disc Menus 29

DVD

Using the DVD Menu

Some DVDs contain menus that describe the contents of the Disc or allow you to customize Disc playback. For example, the menu may offer choices for subtitle languages, director's commentary, or soundtrack playback.

To use the DVD menu and select playback features, follow these steps.

1

When a DVD is inserted and the TV/DVD is in DVD mode, **press the DVD button, then press the MENU button.** The Disc's main menu will appear.

2

Press the arrow buttons (▲/▼/◀/▶) to select an item, then press the ENTER button. Continue this process to set up all the features you wish to see on the Disc.

To access the DVD's Main Menu...

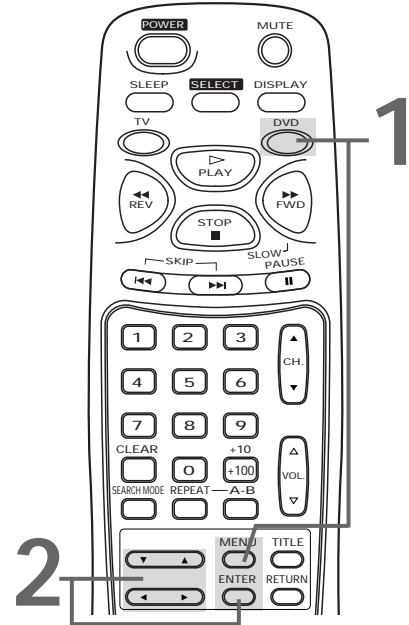

Using the Title Menu

Some DVDs have a Title Menu, which lists the Titles available on the Disc. Use the Title Menu to start playback at a specific Title. Some DVDs may allow you to choose Chapters from the Title menu.

For example, if a DVD has 10 Titles and you want to go directly to Title 5, follow these steps.

1

When a DVD is inserted and the TV/DVD is in DVD mode, **press the DVD button, then press the TITLE button.** The Title Menu will appear.

If a Title menu is not available, the  symbol will appear on the TV screen. If the DVD only has a main menu, the main menu may appear when you press the TITLE button.

2

Press the arrow buttons (▲/▼/◀/▶) to select the desired Title, then press the ENTER button. Playback will begin at the Title you selected.

To access the DVD's Title Menu...

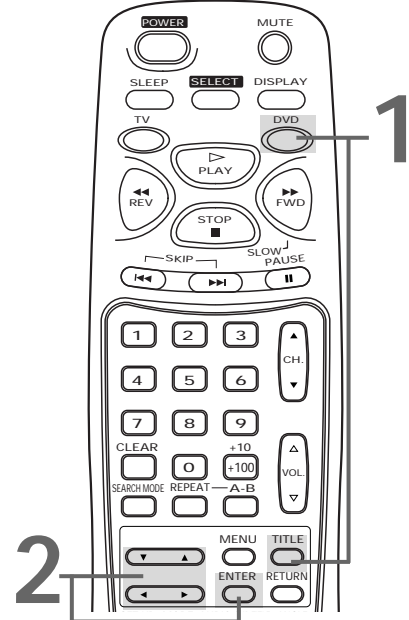

Helpful Hints

- Menus may vary among Discs. Refer to the information accompanying the Disc for details.
- Not all DVDs have Title menus.
- Some DVDs may refer to Chapters as "scenes." Some DVDs may refer to the Title Menu as the "scene index."

30 Pausing Playback

DVD AUDIO CD

Pausing Playback

1

During playback, press the DVD button, then press the PAUSE button. Playback will pause and the sound will be muted.

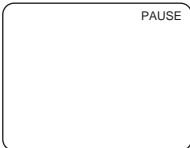

2

Press the PLAY button to resume playback.

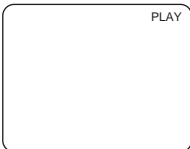

Pausing Playback...

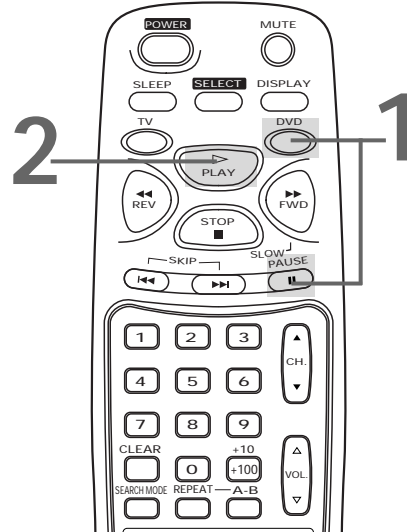

DVD

Memory On: Resuming playback from the point where playback stopped

1

Press the DVD button, then press the STOP button during playback. Playback will stop, and STOP will appear at the top right corner of the TV screen. In a few seconds, MEMO ON (Memory On) will appear in the top left corner of the TV screen.

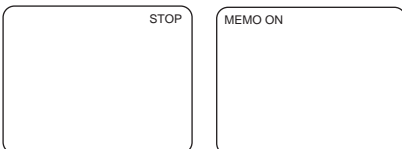

2

Press the PLAY button. Playback will resume from the point where playback stopped last.

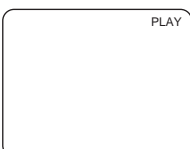

Memory On...

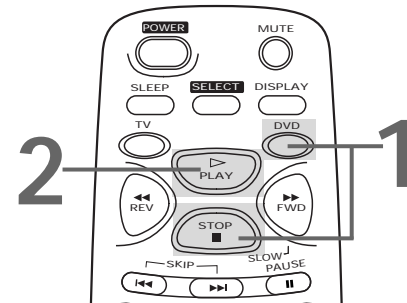

Helpful Hints

- Memory On can be erased by pressing the STOP button a second time while playback is stopped. MEMO OFF will appear briefly at the top left corner of the TV screen.
- Memory On is not available with Audio CDs.
- The TV/DVD may turn itself off automatically after being in Pause mode for 30 minutes. This helps avoid the possible burning of the still image into the TV screen.

Step by Step Playback/Slow Motion 31

DVD

Step by Step Playback

1

During playback, press the DVD button, then press the PAUSE button to pause playback. The sound will be muted.

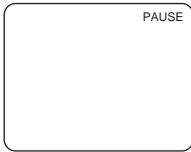

2

Press the PAUSE button repeatedly to see the picture advance one frame (or step) at a time.

The sound will remain muted. PAUSE will appear briefly on the screen each time you press the PAUSE button.

3

Press the PLAY button to resume playback.

PLAY will appear briefly on the screen.



DVD

Slow Motion

1

Press the DVD button, then press the PAUSE button during playback.

2

Press the SLOW/FWD button. Slow motion playback will begin.

Press the SLOW/FWD button repeatedly during slow motion playback to vary the speed of slow motion playback.

You may play the DVD at 1/16, 1/8, or 1/2 the normal playback speed.

3

Press the PLAY button to return to normal playback.

Step by Step Playback...

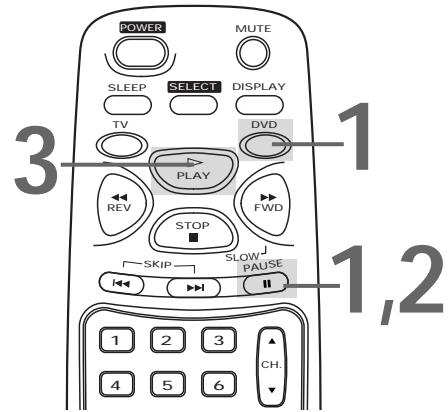

Slow Motion...

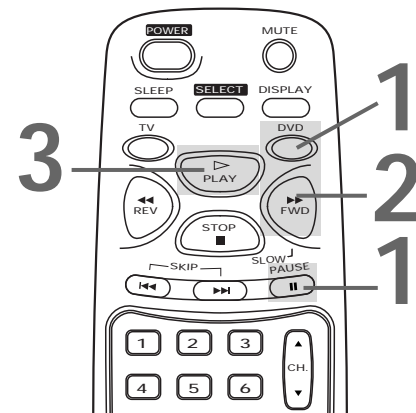

Helpful Hints

- The sound will be muted when playback is paused and during slow motion playback.
- You can not play the DVD in reverse slow motion.

32 Fast Forward/Reverse Search

DVD AUDIO CD

1

During playback, press the DVD button, then press the SLOW/FWD button or the REV button on the remote control.

- On a DVD, pressing the SLOW/FWD or REV button repeatedly will forward or reverse the picture at twice, eight times, or 32 times the normal playback speed. Sound will be muted during searching.
- Use the SLOW/FWD button for a forward search. Press the REV button for a reverse search.

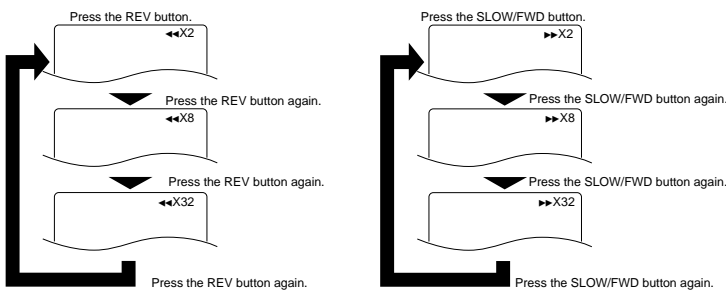

- On an Audio CD, you may search forward or backward at 16 times the normal playback speed ($\lll X16$ or $\ggg X16$). Pressing the SLOW/FWD or REV button repeatedly will not affect the speed of the search. Sound will be intermittent during searching on an Audio CD.
- Use the SLOW/FWD button for a forward search. Press the REV button for a reverse search.

Press the REV button during Audio CD playback.



Press the SLOW/FWD button during Audio CD playback.



2

Press the PLAY button to return to normal playback.

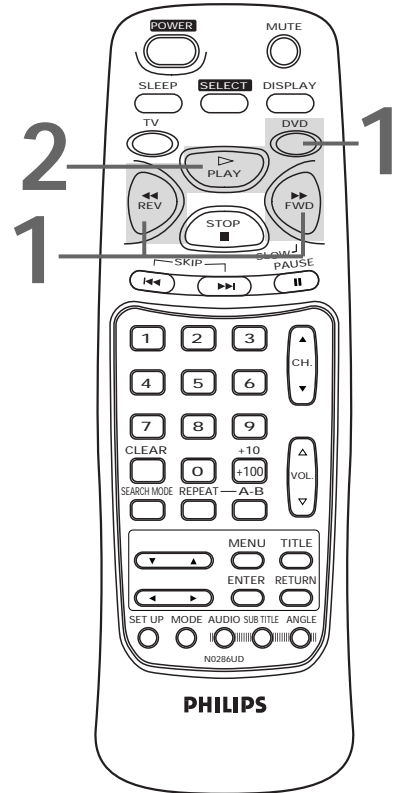

AUDIO CD

Starting Playback at a Specific Track

There are three ways to begin playback on an Audio CD at a specific Track. You may use the Number buttons, the SEARCH MODE button, or the SKIP ◀◀▶▶ buttons. For details, read the information below.

A

Using the Number Buttons to Select a Track

Press the DVD button, then press the Number buttons to enter the desired Track number. The selected Track will be located, and playback will start. You may select a Track with the Number buttons during playback or when playback is stopped.

For single-digit Tracks, press a single Number button. For example, to play Track three, press the Number 3 button.

For Tracks numbered 10 and above, press the +10/+100 button (repeatedly, if necessary), then press the Number button of the second digit. For example, to play Track 12, press the +10/+100 button once, then press the Number 2 button. For Track 22, press the +10/+100 button twice, then press the Number 2 button.

If you enter a Track number that is not available on the Disc, playback will not begin (or the current Track will continue to play). The “No Feature” symbol may appear. *Details are on page five.*

B

Using the SEARCH MODE Button to Select a Track

Press the DVD button, then press the SEARCH MODE button once. Press the ▲ or ▼ button to select the Track number you desire. Finally, press the PLAY button to begin playback at the selected Track.

If you press the SEARCH MODE button once during playback, the current Track number will be displayed inside the brackets.

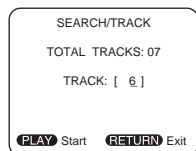

C

Using the SKIP ◀◀▶▶ Buttons to Select a Track

Press the DVD button, then press the SKIP ▶▶ button during playback to skip the current Track and move to the next Track. Press the SKIP ▶▶ button repeatedly to skip subsequent Tracks. The Track number will appear briefly on the TV screen.

Press the DVD button, then press the SKIP ◀◀ button during playback to return to the beginning of the current Track. Press the SKIP ◀◀ button repeatedly to go to previous Tracks. The Track number will appear briefly on the TV screen.

If you press a SKIP button when playback is paused, you must press the PLAY button to resume playback.

If you press a SKIP button when playback is stopped, the selected Track will begin playing automatically.

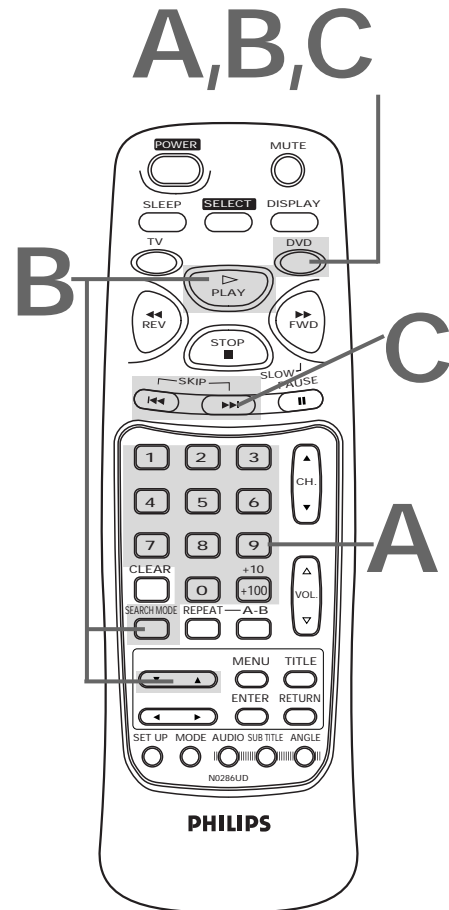

34 Title/Chapter Playback

DVD

Starting Playback at a Specific Title/Chapter

There are two ways to begin DVD playback at a specific Title or Chapter. You may use the Number buttons or the SEARCH MODE button.

A

Using the Number Buttons to Select a Title/Chapter During playback, press the DVD button, then press the Number buttons to select a Chapter. The Chapter will be located and playback will start.

When playback is stopped, press the Number buttons to select a Title. The Title will be located and playback will begin. For single-digit Chapters or Titles, press a single Number button. For example, to play Chapter three, press the Number 3 button during playback. To play Title two, press the Number 2 button while playback is stopped.

For Chapters/Titles numbered 10 and above, press the +10/+100 button (repeatedly, if necessary), then press the Number button of the second digit. For example, to play Chapter 12, press the +10/+100 button, then press the Number 2 button during playback. For Title 22, press the +10/+100 button twice, then press the Number 2 button when playback is stopped.

B

Using the SEARCH MODE Button to Select a Title/Chapter To start playback at a specific Chapter, press the DVD button, then press the SEARCH MODE button once, then press the Number buttons or the ▲ or ▼ button to enter the Chapter number. Press the PLAY button to begin playback at the selected Chapter. If you press the SEARCH MODE button during playback, the current Chapter will appear inside the brackets.

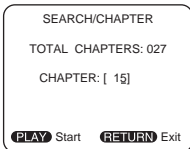

To start playback at a specific Title, when playback is stopped, press the DVD button, then press the SEARCH MODE button twice, then press the Number buttons or the ▲/▼ buttons to enter the Title number. Press the PLAY button to begin playback at the selected Title.

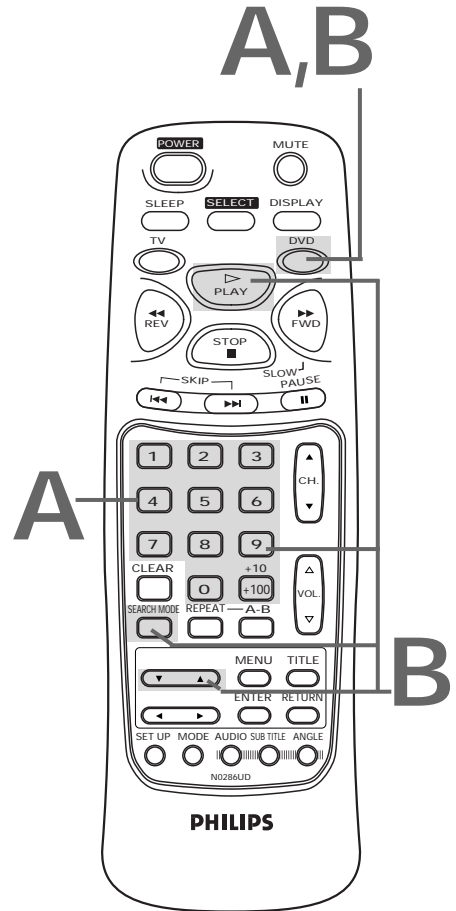

DVD

AUDIO CD

Starting Playback at a Specific Disc Time

1

Press the **DVD** button, then press the **SEARCH MODE** button repeatedly (three times for DVDs or two times for Audio CDs).

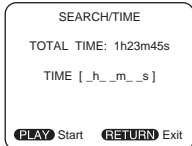

2

Use the **Number** buttons to enter the Disc time at which you want playback to begin.

- Example: 1 hour, 23 minutes and 30 seconds
 1 → +10/+100 → +10/+100 → 3 → +10/+100 →
 +10/+100 → +10/+100 → 0
- To enter a zero, press the Number 0 (zero) button or press the ► button.
- Make sure the time you enter is within the total time of the Disc. If it is not, the information will be cleared. Enter an appropriate time.
- If you make a mistake, press the ► button repeatedly until you reach the item you need to correct (hour, minute, or second), then enter the correct information.

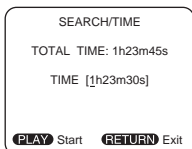

3

Within 30 seconds, press the **PLAY** button. Playback will start at the time that you specified.

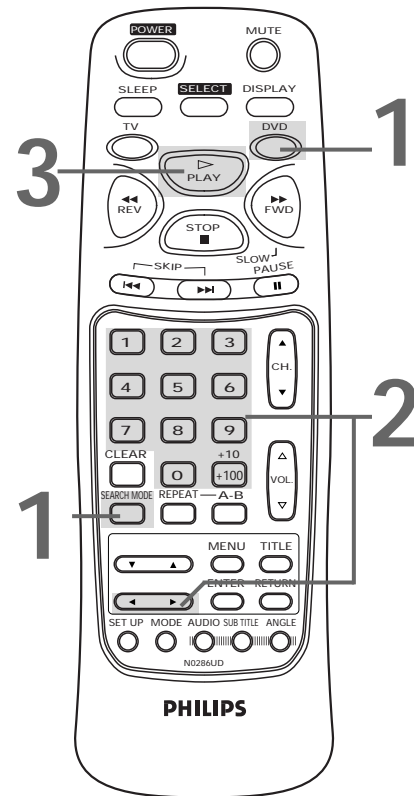

Helpful Hint

- Specific time playback is not available with some discs.

36 Repeat Playback

1

Press the DVD button, then press the REPEAT button repeatedly until the repeat mode you want appears in the top left corner of the TV screen.

DVD

- Repeatedly pressing the REPEAT button during playback lets you choose REPEAT CHAPTER, REPEAT TITLE, or REPEAT OFF.
- If a Chapter is playing repeatedly, then you press the Number buttons to select a new Chapter, the new Chapter will play repeatedly.

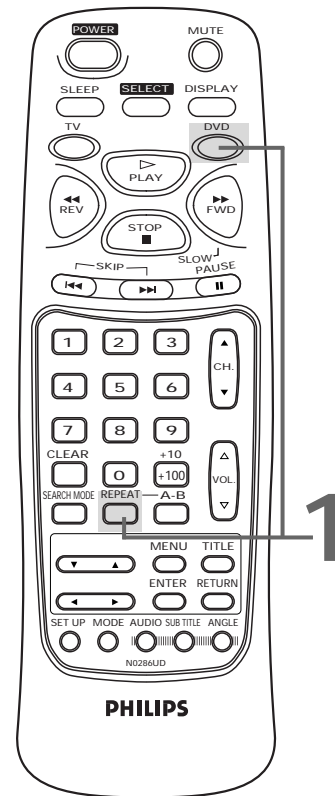
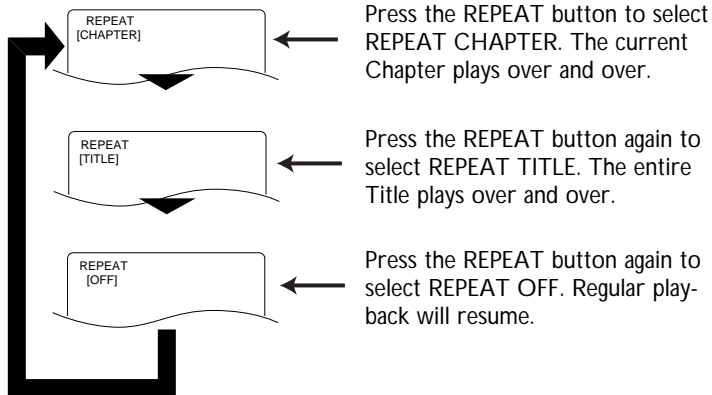

AUDIO CD

- Repeatedly pressing the REPEAT button during playback lets you choose REPEAT TRACK, REPEAT ALL and REPEAT OFF.
- If a Track is playing repeatedly, then you press the Number buttons to select a new Track, the new Track will play repeatedly.

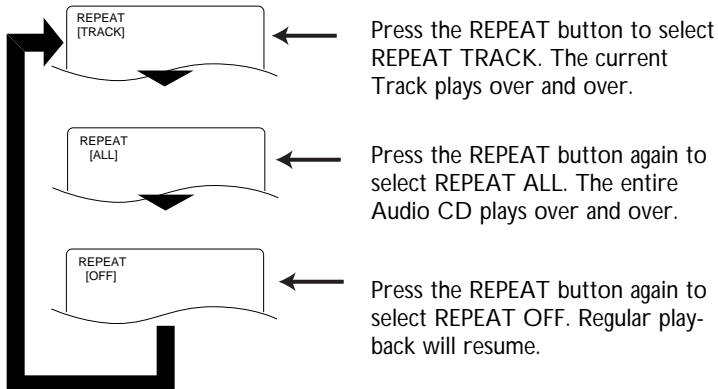

Helpful Hint

- Repeat playback is not available with some discs.

A-B Repeat Playback 37

DVD

AUDIO CD

You can play a section of an Audio CD or DVD repeatedly. Follow these steps to set up the section that you want to play over and over.

1

Press the DVD button, then press the PLAY button to play the Disc to the point at which you want repeated playback to begin.

2

Press A-B REPEAT button to set the starting point (A).

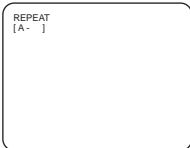

3

Play or fast forward the Disc to the point at which you want repeated playback to end, then press the A-B REPEAT button again.

The section will begin to play immediately, playing over and over until you cancel the A-B Repeat feature.

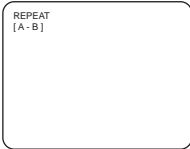

4

To cancel the A-B Repeat feature, press the A-B REPEAT button so that REPEAT [OFF] appears on the TV screen. Regular Disc playback will resume.

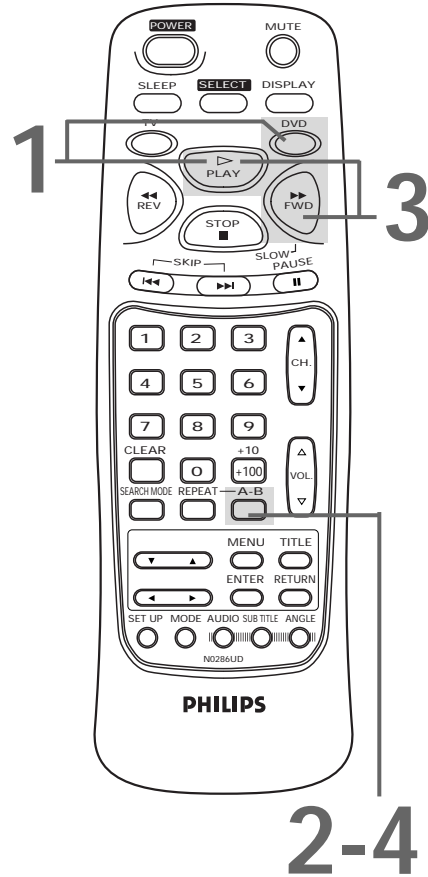
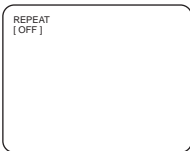

Helpful Hints

- A-B Repeat playback is not available with some DVDs.
- The entire A-B repeat section must be within a single Title or Track.
- Point B must be later on the Disc than Point A.

38 Programmed Playback

AUDIO CD

You may determine the order in which Tracks will play. The order that you set is called the Program. To set up programmed playback, follow these steps.

1

While playback is stopped, press the DVD button, then press the MODE button. The program screen will appear.

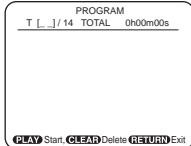

2

Press the Number buttons or the ▲ or ▼ button to enter the number of the first Track that you want to play. Then, press the ENTER button to store the selected Track in the Program.

- If you enter a wrong Track number, press the CLEAR button. The last Track in the Program will be removed. Or, press the Number buttons again to enter a different track.
- Enter single-digit Track numbers by pressing a single Number button.
- Enter double-digit Track numbers by pressing the +100/+10 button as often as necessary, then pressing a Number button for the second digit. *Details are on page 12.*

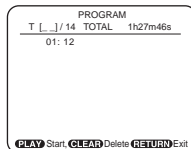

3

Repeat step 2 until you have selected all the Tracks you wish to play in the Program.

- Up to 20 Tracks may be stored in the Program.
- Make sure the Track numbers you enter are available on the Audio CD. If you enter an invalid number, you must try again to enter a valid number.

4

Press the PLAY button. The Tracks will play in the order in which you programmed them. The Program will play once.

- The contents of the program will be stored until you turn off the TV/DVD or open the Disc tray. To play the program again later, when playback is stopped, press the DVD button, then press the MODE button to see the program. Press the PLAY button to start programmed playback.

2-3

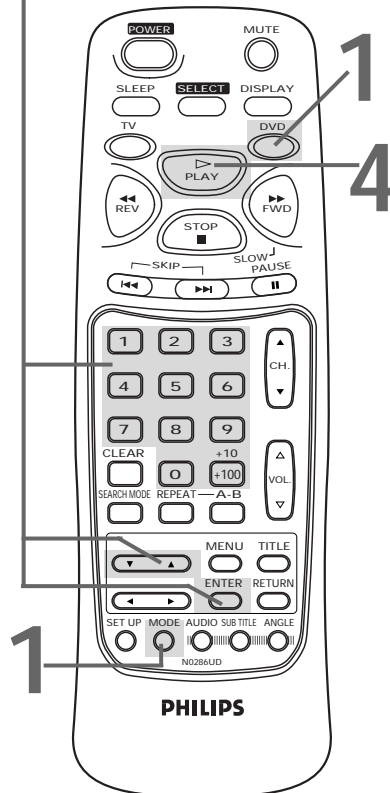

Helpful Hints

- Random playback cannot be combined with programmed playback.
- You may play a Program repeatedly. During programmed playback, press the REPEAT button so that REPEAT [ON] appears on the screen. The program will play over and over.
- To see which Tracks you stored in the Program, press the STOP button to stop playback, then press the MODE button so that the PROGRAM screen appears.
- You can not use the Number buttons to skip to a different Track during programmed playback.

Random Playback 39

AUDIO CD

You may play the Tracks of an Audio CD in Random order instead of the order in which they are recorded (1,2,3...). To set up Random Playback, follow these steps.

1

Press the DVD button.

2

While playback is stopped, press the MODE button repeatedly so that the RANDOM screen appears.

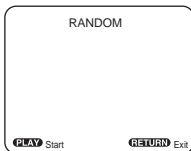

3

While the RANDOM screen appears, press the PLAY button. The Tracks will play in random order. After all the Tracks on the disc have played once, playback will stop.

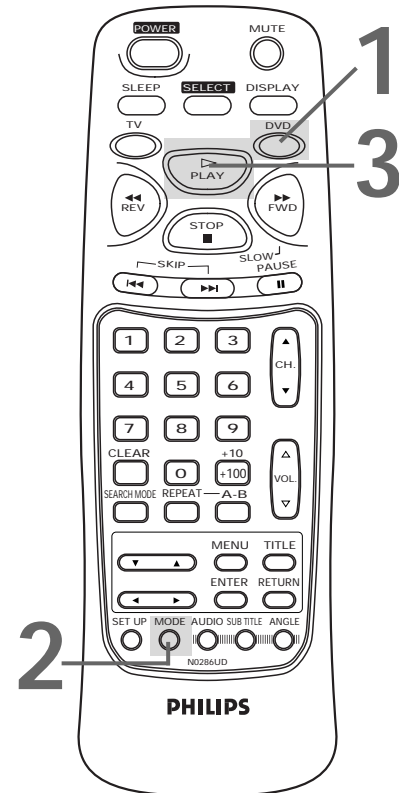

40 Audio Language/Sound Mode

The TV/DVD allows you to select a Language for DVDs or a Sound Mode for Audio CDs.

DVD Language

1

Press the DVD button.

2

Press the AUDIO button during playback, then press the ▲ or ▼ button to select the desired language. The language can be changed only if multiple languages are available on the DVD.

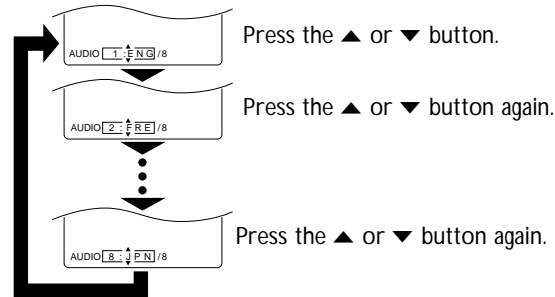

AUDIO 1

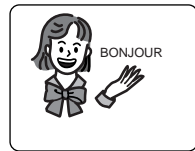

AUDIO 2

AUDIO CD Sound Mode

1

Press the DVD button.

2

Press the AUDIO button during playback, then press the ▲ or ▼ button until the sound mode you want appears.

- When producers record an Audio CD, they record the sound on two channels - the left and the right. You can choose to hear the sound on the left channel, the sound on the right channel, or the sound on both channels (Stereo). You will select L-CH, R-CH, or STEREO.

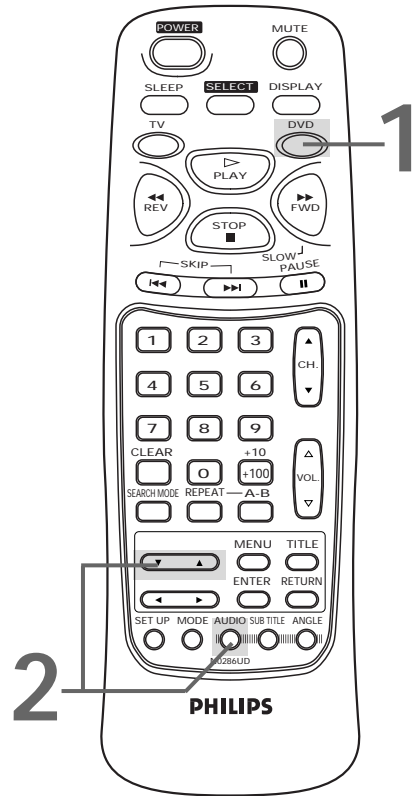
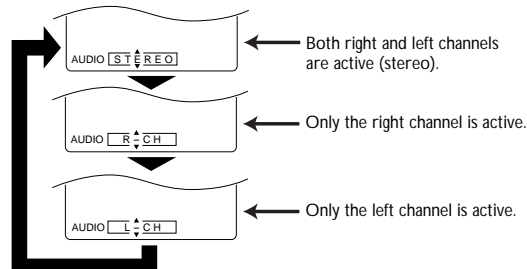

Helpful Hints

- If a desired language is not shown after pressing the ▲ or ▼ button several times, the DVD does not have that language.
- The display will disappear after about 15 seconds.
- Some DVDs only allow you to change the language in the Disc menu.
- When you use the DIGITAL AUDIO OUT COAXIAL jack, the sound mode of audio CDs cannot be changed.

Subtitle Language 41

DVD

The TV/DVD allows you to select a language for subtitles.

1

Press the DVD button.

2

Press the **SUBTITLE** button during playback. The subtitle menu will appear on the screen.

3

Within 15 seconds, press the **▲** or **▼** button to select a subtitle language. Select a language from those available on the DVD.

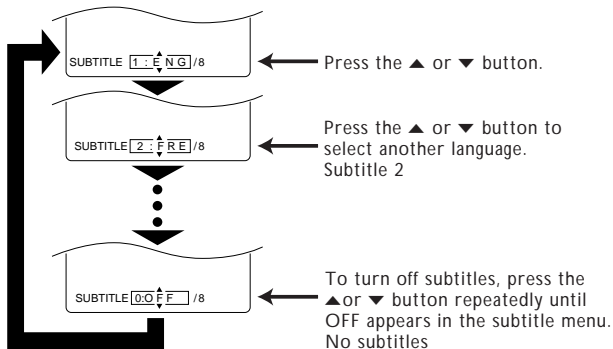

SUBTITLE 1

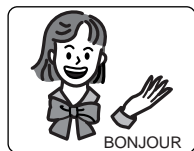

SUBTITLE 2



4

The subtitle menu will disappear after about 15 seconds.

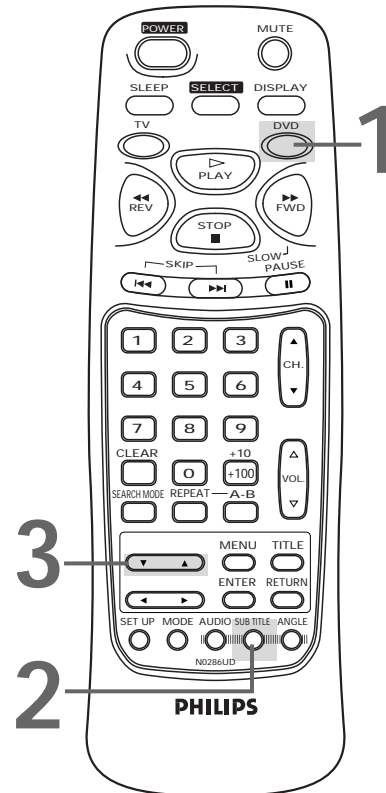

Helpful Hints

- With some DVDs, you may select a subtitle language in the Disc menu.
- If the desired language is not shown after pressing the ▲ or ▼ button several times, the Disc does not have subtitles in that language.
- The subtitles may be delayed for a few seconds.
- Your subtitle selection will be cancelled if you open the Disc tray or turn off the power. The default setting of the DVD will be selected again.

42 Camera Angles

DVD

Some DVDs contain scenes that were recorded from different angles. You may select a camera angle with the TV/DVD remote control.

1

Press the DVD button.

2

Press the ANGLE button during playback.

3

Within 15 seconds, press the ▲ or ▼ button to select a different angle.

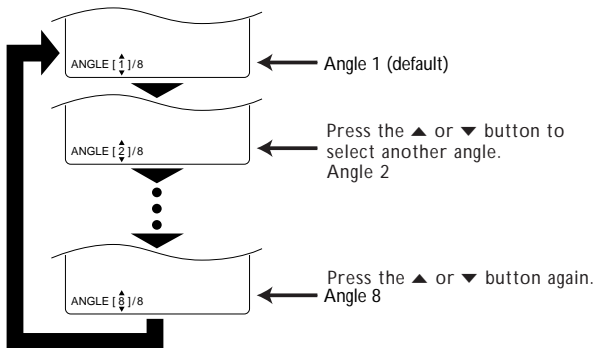

- If the Disc contains sequences recorded from different camera angles, the angle symbol  will appear at the bottom-right of the screen. You can change the camera angle when the symbol appears on the screen.
- The camera angle cannot be changed if the Disc does not contain sequences recorded from different camera angles.

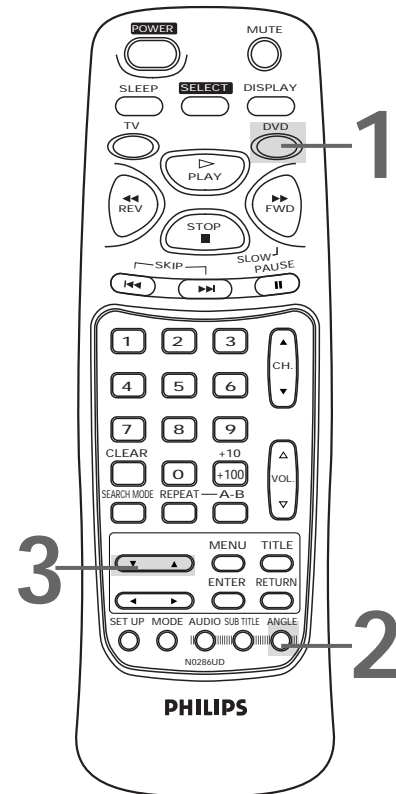

Helpful Hints

- The ANGLE ICON must be set to ON in order for the angle symbol to appear as described in step 3. To set ANGLE ICON to ON, see page 52.
- If the angle status appears on the screen (for example, ANGLE [1]/8), the angle symbol will not appear on the screen.

Parental Lock Password 43

Parental Lock allows you to limit viewing of DVDs if the disc rating exceeds your limitations. Parental Lock only affects playback of DVDs. The Parental Lock settings have no effect on TV programming. To limit TV viewing, use the V-Chip settings. *Details are on pages 24-26.*

In order to change the Parental Lock settings, you must use a password. Follow the steps below to set your password. Then, follow the steps on page 44 to choose your Parental Lock settings.

1

While playback is stopped, press the DVD button, then press the SETUP button. The setup screen will appear.

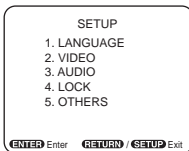

2

Press the Number 4 button to select LOCK. The SETUP/LOCK menu will appear.

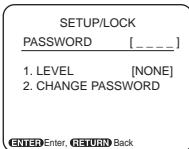

3

Press the Number buttons to enter the 4-digit password.

- When doing this for the first time, enter any 4 digits. That number will be the password until you change it.

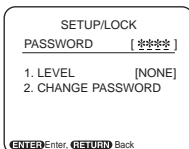

4

Press the Number 2 button to select CHANGE PASSWORD. The first space in the PASSWORD will start flashing.

5

Press the Number buttons to enter your new password.

6

Press the RETURN button twice to remove the menu.

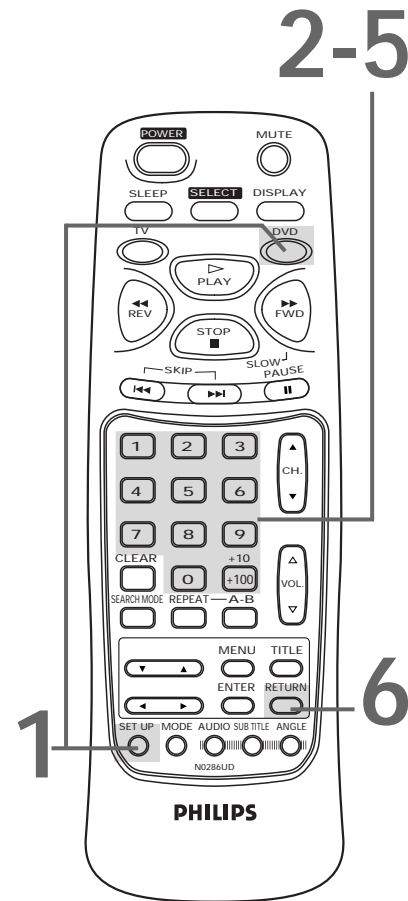

Helpful Hints

- Write down the password in case you forget it.
- You can not select CHANGE PASSWORD until you first enter the correct old password.

44 Parental Lock Levels

1

While playback is stopped, press the DVD button, then press the SETUP button. The setup screen will appear.

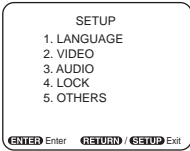

2

Press the Number 4 button to select LOCK. The SETUP/LOCK menu will appear.

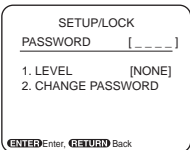

3

Press the Number buttons to enter your 4-digit password.

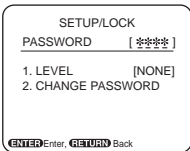

4

Press the Number 1 button to select LEVEL.

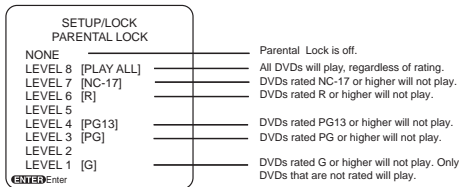

5

Press the ▲ or ▼ button to select the level you want to block, then press the ENTER button. For example, if you want to play Discs rated PG13, you must select LEVEL 5 or higher.

The SETUP/LOCK menu will reappear. The level you selected will appear on the screen beside LEVEL.

6

Press the RETURN button twice to remove the menu.

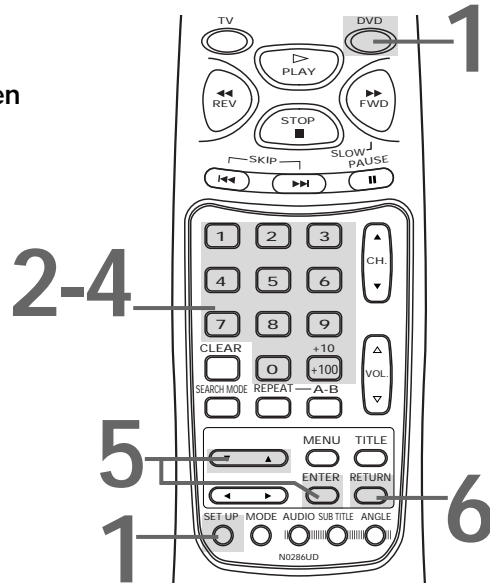

RATING EXPLANATIONS

- NC-17 - Under 17 not admitted
- R - Restricted; under 17 requires accompanying parent or adult guardian
- PG13 - Unsuitable for children under 13
- PG - Parental Guidance suggested
- G - General Audience

Helpful Hints

- Some DVDs are not compatible with Parental Lock. Make sure the DVD plays according to the Parental Lock settings you have made.
- The TV/DVD will not allow you to change LEVEL settings until you enter the correct password.
- When you try to play a Disc that has a rating that exceeds the level you set, a message will appear on the screen, indicating the Disc cannot be played. If this happens, remove the Disc, then select a level that allows playback. Or select NONE to turn off Parental Lock. Load the Disc again and begin playback as usual. Some Discs may allow you to simply enter your 4-digit password, then begin playback automatically. Follow the instructions provided by the Disc message.

Status Display 45

DVD

AUDIO CD

Accessing the Status Display

You can check the information about the current Disc by pressing the DISPLAY button on the remote control.

1

Press the DVD button, then press the DISPLAY button repeatedly to access or remove the status displays.

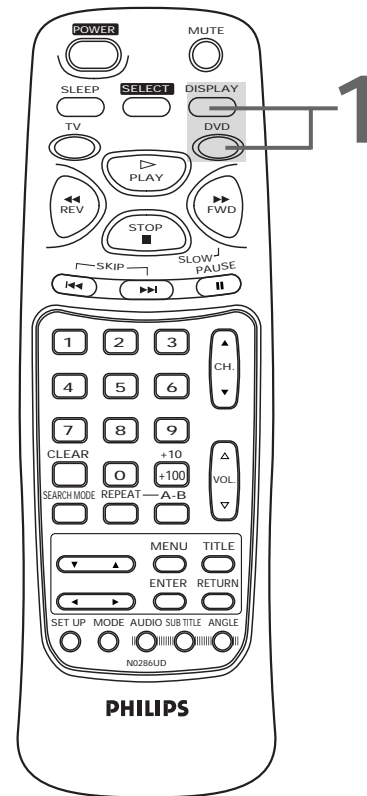

DVD

TITLE	: 01/04	• Current Title number / total number of Titles
TIME	: 0h24m14s	• Elapsed time of the current Title
REMAIN	: 0h05m25s	• Remaining time of the current Title
CHAPTER	: 001/010	• Current Chapter number / total number of Chapters in the current Title
TIME	: 0h02m25s	• Elapsed time of the current Chapter
REMAIN	: 0h01m31s	• Remaining time of the current Chapter

AUDIO	: 1.ENGLISH	• Current language for the sound
	DOLBY DIGITAL	• Current audio format (DOLBY DIGITAL 5.1 Channel is displayed as DOLBY DIGITAL 6 CH.)
SUBTITLE	: 2.FRENCH	• Current language for the subtitles
ANGLE	: 8/8	• Selected angle / total number of angles
VIRTUAL 3D		• VIRTUAL 3D setting (ON/OFF)



No display

AUDIO CD

TRACK	: 01/04	• Current Track number / total Track number
TIME	: 0h05m25s	• Elapsed time of the current Track
REMAIN	: 0h01m31s	• Remaining time of the current Track
PROGRAM		• Current play mode

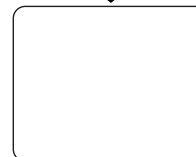

No display

46 Audio Settings

1

Press the DVD button.

2

While playback is stopped, press the SETUP button. The setup screen will appear.

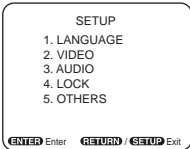

3

Press the Number 3 button to select AUDIO.

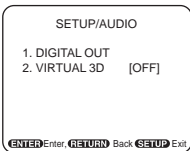

4

Press the corresponding Number button to select an item: DIGITAL OUT or VIRTUAL 3D.

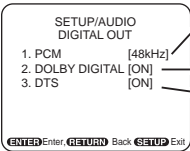

- Sets the sample rate for playing a disc recorded with high sound quality
- Select when a Dolby Digital decoder is connected.
- Select when a DTS decoder is connected.

Go to step 5 to change one of the DIGITAL OUT settings.

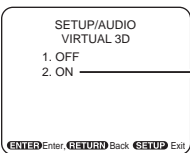

- Select ON to activate the 3D effect.

Press the Number 1 button to turn off VIRTUAL 3D.
Press the Number 2 button to turn on VIRTUAL 3D.
Then, go to step 6.

This unit employs TruSurround system **TruSurround**™ of SRS Labs, Inc. as the VIRTUAL 3D technology.

TruSurround and the  symbol are trademarks of SRS Labs, Inc. in the United States and selected foreign countries.

TruSurround technology is incorporated under license from SRS Labs, Inc.

3-4

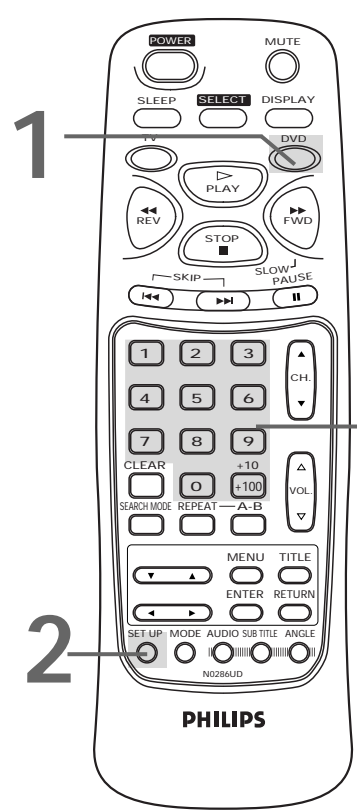

Helpful Hint

- To enjoy Dolby Digital Surround or DTS Surround sound, you must have the TV/DVD connected to a Dolby Digital or DTS decoder. Details are on page 10.

5

To change the PCM, DOLBY DIGITAL, or DTS settings, press the corresponding Number button to select the desired item, then press the Number button to choose the setting (i.e. ON or OFF).

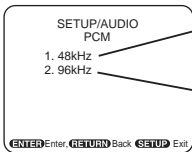

- Audio signals are converted to 48 kHz/16 bit signals when playing a DVD recorded with high sound quality (48 kHz/20 bit/24 bit, 96 kHz).
- Sound is reproduced at 96 kHz if a DVD is recorded with high sound quality. If you are playing 48 kHz discs or if 4:3 LETTER BOX is selected, sound is reproduced at 48 kHz.

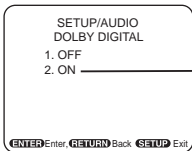

- Select ON when a Dolby Digital decoder is used.

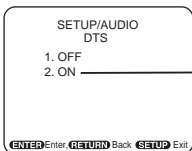

- Select ON when a DTS decoder is used.

6

Press the SETUP button to remove the DVD Player menu.

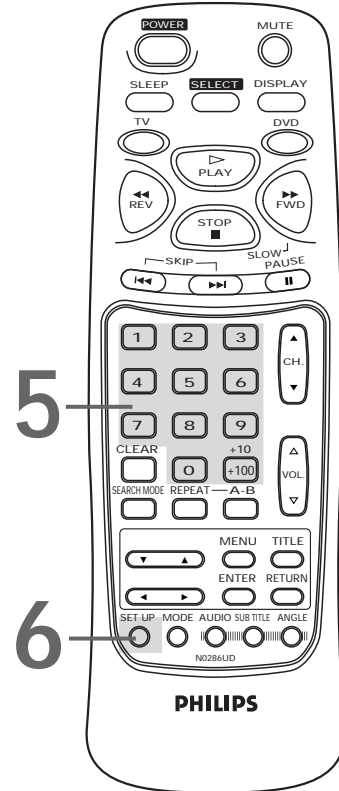

48 Language Settings

DVD

These settings affect the language of the current disc and the DVD Player. These settings have no effect on the TV menus.

1

Press the DVD button.

2

While no disc is inserted, press the SETUP button. The setup screen appears.

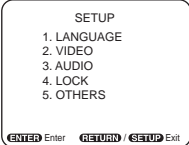

3

Press the Number 1 button to select LANGUAGE.

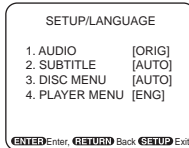

4

Press a Number button to select an item: AUDIO, SUBTITLE, DISC MENU, or PLAYER MENU.

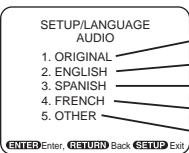

- The original language of each disc will be selected.
- Voice is played back in English.
- Voice is played back in Spanish.
- Voice is played back in French.
- You can select other languages for audio playback.

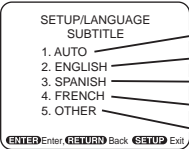

- Subtitles are shown in the automatically selected language.
- Subtitles are shown in English.
- Subtitles are shown in Spanish.
- Subtitles are shown in French.
- You can select other languages for subtitles.

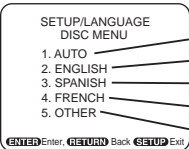

- The disc menu is shown in the automatically selected language.
- The disc menu appears in English.
- The disc menu appears in Spanish.
- The disc menu appears in French.
- You can select other languages for the disc menu.

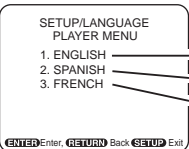

- The on-screen display and DVD Player menus appear in English.
- The on-screen display and DVD Player menus appear in Spanish.
- The on-screen display and DVD Player menus appear in French.

Go to step 5 to change the settings within AUDIO, SUBTITLE, DISC MENU or PLAYER MENU.

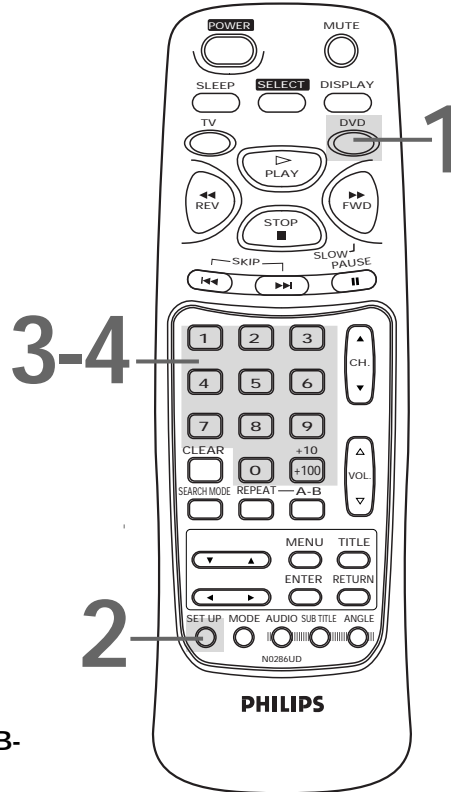

Helpful Hints

- If the automatic settings for AUDIO and SUBTITLE are the same language, the subtitles will not be shown.
- Language settings for AUDIO and SUBTITLE are not available with some discs. Use the AUDIO and SUBTITLE buttons instead to select different languages for the audio and subtitles. Details are on pages 40 and 41.

5

Press a Number button to select a setting.

- If OTHER is selected on the AUDIO, SUBTITLE or DISC MENU screen, the COUNTRY CODE screen will appear. Press four Number buttons to enter the country code you desire, then press the ENTER button. Refer to the country code list on page 50. The list is alphabetized according to language.
- You can only select other languages for AUDIO, SUBTITLE, and DISC MENU if the language is available on the Disc.



6

Press the SETUP button to remove the menu.

7

Insert a disc.

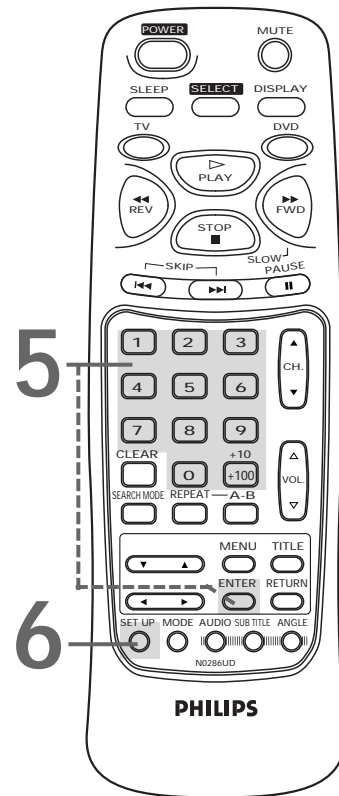

Helpful Hint

- If a disc is already in the TV/DVD when you change the language, press the OPEN/CLOSE button on the TV/DVD once to open the tray, then press the OPEN/CLOSE button again to close the tray. The language setting will be effective after the disc is loaded.

50 Language Settings (cont'd)

<u>Language</u>	<u>Country Code</u>	<u>Language</u>	<u>Country Code</u>	<u>Language</u>	<u>Country Code</u>
	A-B		I-K		S
Abkhazian	4748	Icelandic	5565	Samoan	6559
Afar	4747	Indonesian	5560	Sangho	6553
Afrikaans	4752	Interlingua	5547	Sanskrit	6457
Albanian	6563	Interlingue	5551	Serbian	6564
Amenian	5471	Inupiak	5557	Serbo-Croatian	6554
Amharic	4759	Irish	5347	Sesotho	6566
Arabic	4764	Italian (ITA)	5566	Setswana	6660
Assamese	4765	Japanese (JPN)	5647	Shona	6560
Aymara	4771	Javanese	5669	Sindhi	6550
Azerbaijani	4772	Kannada	5760	Singhalese	6555
Bangla	4860	Kashmiri	5765	Siswat	6565
Bashkir	4847	Kazakh	5757	Slovak	6557
Basque	5167	Kinyarwanda	6469	Slovenian	6558
Bengali	4860	Kirghiz	5771	Somali	6561
Bhutani	5072	Kirundi	6460	Spanish (SPA)	5165
Bihari	4854	Korean (KOR)	5761	Sundanese	6567
Bislama	4855	Kurdish	5767	Swahili	6569
Breton	4864		L-N	Swedish	6568
Bulgarian	4853	Laothian	5861		T
Burmese	5971	Latin	5847	Tagalog	6658
Byelorussian	4851	Latvian	5868	Tajik	6653
	C-E	Lettish	5868	Tamil	6647
Cambodian	5759	Lingala	5860	Tatar	6666
Catalan	4947	Lithuanian	5866	Telugu	6652
Chinese (CHI)	7254	Macedonian	5957	Thai	6654
Corsican	4961	Malagasy	5953	Tibetan	4861
Croatian	5464	Malay	5965	Tigrinya	6655
Czech	4965	Malayalam	5958	Tonga	6661
Danish	5047	Maltese	5966	Tsonga	6665
Dutch (DUT)	6058	Maori	5955	Turkish	6664
English (ENG)	5160	Marathi	5964	Turkmen	6657
Esperanto	5161	Moldavian	5961	Twi	6669
Estonian	5166	Mongolian	5960		U-Z
	F-H	Nauru	6047	Ukrainian	6757
Faroese	5261	Nepali	6051	Urdu	6764
Fiji	5256	Norwegian	6061	Uzbek	6772
Finnish	5255		O-R	Vietnamese	6855
French (FRE)	5264	Occitan	6149	Volapuk	6961
Frisian	5271	Oriya	6164	Welsh	4971
Gaelic (Scots)	5350	Oromo (Afan)	6159	Wolof	6961
Galician	5358	Panjabi	6247	Xhosa	7054
Georgian	5747	Pashto	6265	Yiddish	5655
German (GER)	5051	Persian	5247	Yoruba	7161
Greek	5158	Polish	6258	Zulu	7267
Greenlandic	5758	Portugese	6266		
Guarani	5360	Pushto	6265		
Gujarati	5367	Quechua	6367		
Hausa	5447	Rhaeto-Romance	6459		
Hebrew	5569	Romanian	6461		
Hindi	5455	Russian	6467		
Hungarian	5467				

1

Press the DVD button.

2

When playback is stopped, press the SETUP button. The setup screen will appear.

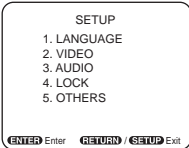

3

Press the Number 2 button to select VIDEO.

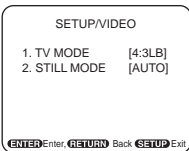

4

Press the corresponding Number button to select an item: TV MODE or STILL MODE.

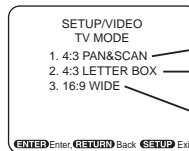

- Full-height pictures are shown, with one or both sides trimmed.
- Wide screen (full-width) pictures are shown, with black bars at top and bottom.
- not available for TV/DVD

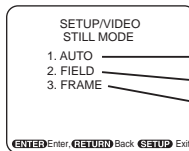

- AUTO is normally selected.
- Select if pictures are blurred in auto mode.
- Select to show Still pictures in high resolution.

5

Press the corresponding Number button to select a setting.

6

Press the SETUP button to remove the menu.

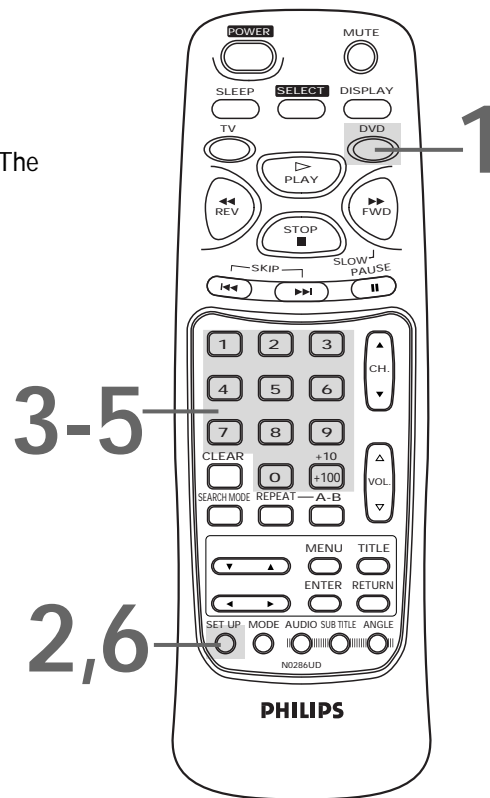

Helpful Hint

- You may select a different TV MODE setting only if it is available on the Disc.

52 Other Menu Settings

1

Press the DVD button.

2

Press the SETUP button. The setup screen will appear.

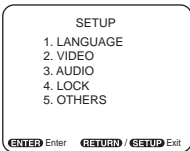

3

Press the Number 5 button to select OTHERS.

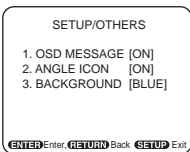

4

Press the corresponding Number button to select an item: OSD MESSAGE, ANGLE ICON, or BACKGROUND.

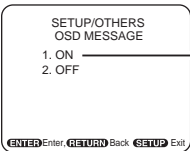

• Select ON to display messages on the screen, such as PLAY, STOP, etc.

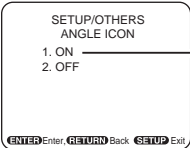

• Select ON to display the angle icon.

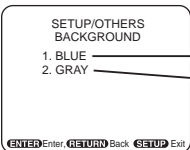

• Turns the menu background to blue
• Turns the menu background to gray

5

Press a Number button to select a setting.

6

Press the SETUP button to remove the menu.

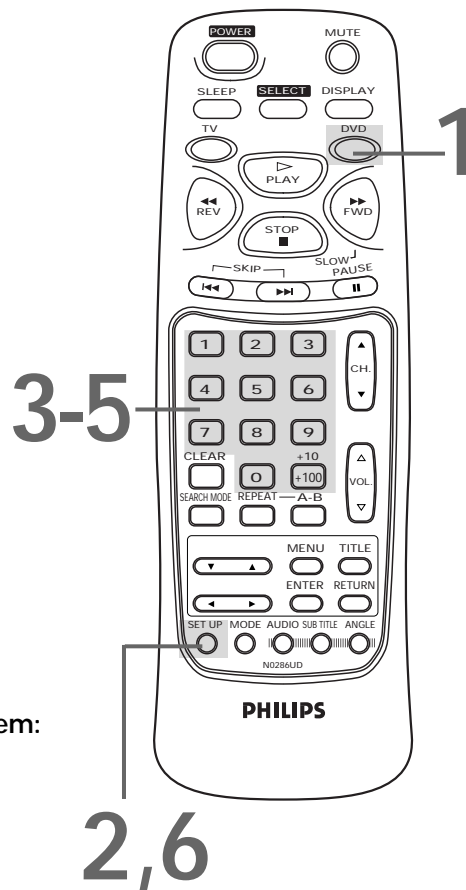

Care and Maintenance 53

Cleaning the TV/DVD

- Wipe the front panel and other exterior surfaces of the TV/DVD with a soft, slightly damp cloth.
- Never use a solvent, thinner, benzene or alcohol to clean the TV/DVD. Do not spray insecticide liquid near the TV/DVD. Such chemicals may discolor the surface or damage the TV/DVD.

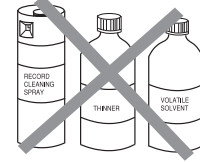

Don't use cleaners.

Cleaning a Disc

- Use a soft, dry cloth to wipe the Disc.
- Wipe the Disc in a straight line from the center to the edge. Never wipe the Disc in a circular motion.
- Do not use detergent or abrasive cleaning agents.
- Handle the Discs so that fingerprints and dust do not adhere to the surfaces of the Discs.
- Always store the Disc in its protective case when it is not in use.

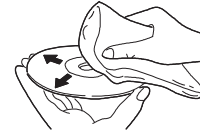

Wipe Discs from the center to the edge.

Checking the Laser

- If the TV/DVD does not operate as described in this owner's manual, the laser may be dirty. Consult an Authorized Service Center for inspection and cleaning of the laser.

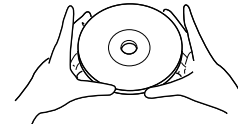

Handle Discs by the edges.

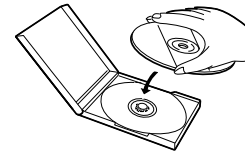

Keep the Disc in its case.

54 Helpful Hints

If you are having problems with your product, check this list of problems and possible solutions before requesting service. You may be able to solve the problem yourself.

If you need to call a customer service representative, please know the model number and serial number of your product before you call. This information is displayed on the back of the product. Also, please take a moment to identify the problem you are having, and be prepared to explain this to the representative. If you believe the representative will need to help you with operations, please stay near the product. Our representatives will be happy to assist you.

Color is poor when in TV mode.

- Try a different channel.
- Connect the antenna or cable signal securely. *Details are on pages seven-eight.*
- Adjust the picture. *Details are on page 23.*

Poor TV Channel Reception

- Set up the available channels. *Details are on page 19.*
- Try a different channel.
- Connect the antenna or cable signal securely. *Details are on pages seven-eight.*

Closed Captions are delayed, incorrect, or missing.

- Captions that are delayed a few seconds behind the actual dialogue are common for live broadcast.
- Captions and text may not match the TV broadcast exactly. This is not a problem with the TV/DVD.
- Buildings, power lines, thunderstorms, or other factors may interfere with the broadcast and cause scrambled or incomplete captions to appear.

The program listings indicate that the show has Closed Captions, but captions are not displayed.

- Broadcasters may compress the program so that additional advertising time can be given. Since the compressed information can not be read, captions will not appear.

The TV/DVD has no power.

- Make sure the power cord is connected completely to an AC (alternating current) outlet.
- Press the POWER button to turn on the TV/DVD.
- If the TV/DVD is turned on in DVD or VIDEO mode, the screen may be blank.

The remote control will not operate the TV/DVD.

- Aim the remote control directly at the TV/DVD's remote sensor. *Details are on page 15.*
- Remove all obstacles between the remote control and the TV/DVD.
- Inspect and/or replace the batteries in the remote control. *Details are on page 11.*
- Use the remote control within 23 feet of the TV/DVD.
- Connect the TV/DVD's power cord to a power source.
- Press the TV or DVD button before pressing other buttons. *Details are on pages 12-14.*

No DVD picture

- Insert a Disc that is playable on this TV/DVD. *Details are on page six.*

Disc cannot be played.

- Insert a playable Disc. *Details are on page six.*
- Place the Disc correctly in the recesses in the Disc tray. If the Disc is one-sided, place the Disc in the tray with the label facing up. If the Disc is two-sided, make sure the side you want to play is facing up.
- Clean the Disc. *Details are on page 53.*
- Cancel the Parental Lock, enter the password, or change the rating level. *Details are on pages 43-44.*
- Make sure the Disc is labelled for use in Region 1 or ALL regions. *Details are on page six.*

No sound

- Connect the audio cables firmly when connecting the TV/DVD to other sound equipment. *Details are on pages 9-10.*
- Check the audio settings of the TV/DVD. *Details are on pages 46-47.*
- Turn on the power of the audio equipment and make sure it is set to the correct channel, usually Auxiliary IN. Refer to the owner's manual of the audio equipment for details.
- Check the audio settings of the Disc. For example, you may have selected "soundtrack" playback on a DVD. Only the music of the movie will play, not the characters' dialog; music might not be recorded throughout the entire DVD. *Details are on page 40.*

Distorted picture

- There are some cases where the DVD picture may be distorted slightly; this is not a malfunction of the TV/DVD.
- If a TV program's picture is distorted, blurred, or rolling: Check your antenna or cable signal or check other TV channels. Make sure the antenna or cable signal is connected securely. *Details are on pages seven-eight.*

The camera angle cannot be changed.

- The DVD might not contain segments recorded from different camera angles. See if multiple angles are available. *Details are on page 42.*

The audio or subtitle language cannot be changed.

- The DVD does not contain audio or subtitles in the desired language. Not all DVDs contain audio or subtitles in multiple languages. See if other languages are available. *Details are on pages 40-41.*

"No feature" symbol appears on the screen, prohibiting an operation.

- That operation is currently prohibited by the TV/DVD or is not available on the Disc. *Details are on page five.*

A screen saver appears on the screen.

- The DVD whale will appear on the screen if Disc playback is stopped for more than one minute (and no buttons are pressed on the remote control or the TV/DVD). The DVD whale moves around on the screen to prevent damage to the TV/DVD's picture tube. A prolonged still image, including TV station identification logos or video games, may damage the picture tube.

56 Glossary

AUDIO In Jack: jack located on the front of the TV/DVD which is used to receive audio from another source, such as a VCR, camcorder, or stereo. *Details are on page eight.*

AUDIO OUT Jacks: jacks located on the back of the TV/DVD which are used to send audio to another system (decoder or amplifier).

CD: Compact Disc (audio)

Coaxial jack: used to send digital audio to a decoder or amplifier, allowing you to adjust the volume at the decoder or amplifier. This connection provides the 5.1 channel surround sound as heard in movie theaters.

Dolby Digital: A surround sound system that provides 5.1 channel sound as used in movie theaters.

DTS: Digital Theater Systems. This is a surround sound system, but it is different from Dolby Digital. The formats were developed by different companies.

DVD: Digital Video Disc.

Remote Control: the small unit that came with your TV/DVD; allows you to operate your TV/DVD from a distance.

VIDEO In Jack: jack located on the front of the TV/DVD which is used to receive video from another source, such as a VCR or camcorder. *Details are on page eight.*

Specifications 57

TV

Channels: 1-125

Closed Captioning System

§15.119/FCC

Television System

NTSC-M, TV Standard

Tuning System

181 channel frequency synthesized tuning system

DVD

Color System

NTSC

Dynamic Range

DVD (linear sound): 95 dB

Audio CD: 94 dB (EIAJ) (Electronic Industries Association of Japan)

Frequency Response

DVD (linear sound): 20 Hz to 22 kHz
(sample rate: 48 kHz)
20 Hz to 44 kHz
(sample rate: 96 kHz)

Audio CD: 20 Hz to 20 kHz

Playable Discs

DVD-Video

Audio CD

Signal-to-Noise Ratio

Audio CD: 110 dB EIAJ

Total Distortion Factor

Audio CD: 0.007% (EIAJ)

Wow and Flutter

Below the measurement limitation ($\pm 0.001\%$ W PEAK) (EIAJ)

Terminals

Antenna In: VHF/UHF/CATV
75 Ω unbalanced (F-type)
Audio L/R In: Two RCA connectors
Audio L/R Out: Two RCA connectors
Coaxial Digital
Audio Out: One pin jack, 500m Vpp (75 Ω)
Headphone: 1/8" monaural (3.5mm)
Video In: One RCA connector

Operating Temperature

5°C to 40°C (41°F to 104°F)

Power Requirements

AC 120V, 60Hz

Power Consumption (Maximum)

53 W

Dimensions (WxHxD)

19-7/16" x 19-11/16" x 18-11/16"
(494 mm x 500 mm x 475 mm)

Weight

46.3 lbs. (21 kg.)

NOTE: Designs and specifications are subject to change without notice.

**RENEWED
90 DAY
LIMITED WARRANTY**

<p>ac power cord 8, 16</p> <p>accessories 60</p> <p>angle button 14, 42</p> <p>arrow buttons 14</p> <p>audio button 12, 40</p> <p>audio cd 6, 28</p> <p>audio in jacks 8, 15</p> <p>audio out jacks 9, 16</p> <p>a-b repeat 37</p> <p>a-b repeat button 13, 37</p> <p>batteries 11</p> <p>bit rate 47</p> <p>camera angle 42</p> <p>chapters 6, 34</p> <p>clear button 14, 38</p> <p>connections 7-10</p> <p>contents, table of 4</p> <p>controls, remote 12-14</p> <p>digital audio out (pcm/bitstream) coaxial 9-10, 16</p> <p>display button 14, 45</p> <p>dvd video 6</p> <p>enter button 14</p> <p>fast forward 32</p> <p>front panel 15</p> <p>glossary 56</p> <p>helpful hints 54-55</p> <p>hookups</p> <ul style="list-style-type: none"> amplifier with digital in jacks/md deck/dat deck .. 9 antenna 7-8 dolby digital decoder/dts decoder 10 stereo 9 <p>language 18, 48-50</p> <p>limited warranty 58</p> <p>menu button 13</p> <p>menus</p> <ul style="list-style-type: none"> disc 5, 29 dvd player 5, 45-52 tv 5, 18-27 <p>mode button 12, 38-39</p> <p>number buttons 12</p> <p>open/close button 15</p>	<p>parental lock 43-44</p> <p>password 43</p> <p>pause button 13, 30-31</p> <p>play button 13, 15, 28</p> <p>playing 28</p> <p>power</p> <ul style="list-style-type: none"> button 12, 15, 17 cord 16 <p>program 38</p> <p>random 39</p> <p>rear panel 16</p> <p>remote control</p> <ul style="list-style-type: none"> buttons 12-14 sensor 15 using 11 <p>repeat button 13, 36</p> <p>repeat playback 36</p> <p>resuming play 30</p> <p>return button 13</p> <p>rev button 13, 32</p> <p>reverse 32</p> <p>safety precautions 3</p> <p>setup button 12</p> <p>search mode button 14, 33-35</p> <p>setting</p> <ul style="list-style-type: none"> audio 40, 46-47 language 48-50 other 52 video 51 <p>skip buttons 14, 33</p> <p>slow/fwd button 13, 31-32</p> <p>slow motion 31</p> <p>sound mode 40</p> <p>status display 45</p> <p>still picture 30</p> <p>stop button 13, 15</p> <p>subtitle button 14, 41</p> <p>table of contents 4</p> <p>title button 13, 29</p> <p>titles 6, 29</p> <p>tracks 6</p> <p>video in jack 8, 15</p> <p>warranty 58</p>
---	--

SUPPLIED ACCESSORIES

*The following items are supplied with your TV/DVD;
they are provided to help you use or set up your TV/DVD.*



This owner's manual is made of recyclable materials.
Remember to recycle!