

Deluxe Optical Power Meter with Memory

Works with an optical laser source to test optical fiber cables for optical loss.

Works at six wavelengths: 850, 1300, 1310, 1490, 1550, and 1625 nm.



**Customer
Support
Information**

Order toll-free in the U.S.: Call 877-877-BBOX (outside U.S. call 724-746-5500) • FREE technical support 24 hours a day, 7 days a week: Call 724-746-5500 or fax 724-746-0746 • Mailing address: Black Box Corporation, 1000 Park Drive, Lawrence, PA 15055-1018 • Web site: www.blackbox.com • E-mail: info@blackbox.com

FEDERAL COMMUNICATIONS COMMISSION AND
INDUSTRY CANADA RADIO FREQUENCY INTERFERENCE STATEMENTS

This equipment generates, uses, and can radiate radio-frequency energy, and if not installed and used properly, that is, in strict accordance with the manufacturer's instructions, may cause interference to radio communication. It has been tested and found to comply with the limits for a Class A computing device in accordance with the specifications in Subpart B of Part 15 of FCC rules, which are designed to provide reasonable protection against such interference when the equipment is operated in a commercial environment. Operation of this equipment in a residential area is likely to cause interference, in which case the user at his own expense will be required to take whatever measures may be necessary to correct the interference.

Changes or modifications not expressly approved by the party responsible for compliance could void the user's authority to operate the equipment.

This digital apparatus does not exceed the Class A limits for radio noise emission from digital apparatus set out in the Radio Interference Regulation of Industry Canada.

Le présent appareil numérique n'émet pas de bruits radioélectriques dépassant les limites applicables aux appareils numériques de la classe A prescrites dans le Règlement sur le brouillage radioélectrique publié par Industrie Canada.

Normas Oficiales Mexicanas (NOM)
Electrical Safety Statement
INSTRUCCIONES DE SEGURIDAD

1. Todas las instrucciones de seguridad y operación deberán ser leídas antes de que el aparato eléctrico sea operado.
2. Las instrucciones de seguridad y operación deberán ser guardadas para referencia futura.
3. Todas las advertencias en el aparato eléctrico y en sus instrucciones de operación deben ser respetadas.
4. Todas las instrucciones de operación y uso deben ser seguidas.
5. El aparato eléctrico no deberá ser usado cerca del agua—por ejemplo, cerca de la tina de baño, lavabo, sótano mojado o cerca de una alberca, etc.

Deluxe Optical Power Meter with Memory

6. El aparato eléctrico debe ser usado únicamente con carritos o pedestales que sean recomendados por el fabricante.
7. El aparato eléctrico debe ser montado a la pared o al techo sólo como sea recomendado por el fabricante.
8. Servicio—El usuario no debe intentar dar servicio al equipo eléctrico más allá lo descrito en las instrucciones de operación. Todo otro servicio deberá ser referido a personal de servicio calificado.
9. El aparato eléctrico debe ser situado de tal manera que su posición no interfiera su uso. La colocación del aparato eléctrico sobre una cama, sofá, alfombra o superficie similar puede bloquea la ventilación, no se debe colocar en libreros o gabinetes que impidan el flujo de aire por los orificios de ventilación.
10. El equipo eléctrico deber ser situado fuera del alcance de fuentes de calor como radiadores, registros de calor, estufas u otros aparatos (incluyendo amplificadores) que producen calor.
11. El aparato eléctrico deberá ser conectado a una fuente de poder sólo del tipo descrito en el instructivo de operación, o como se indique en el aparato.
12. Precaución debe ser tomada de tal manera que la tierra fisica y la polarización del equipo no sea eliminada.
13. Los cables de la fuente de poder deben ser guiados de tal manera que no sean pisados ni pellizcados por objetos colocados sobre o contra ellos, poniendo particular atención a los contactos y receptáculos donde salen del aparato.
14. El equipo eléctrico debe ser limpiado únicamente de acuerdo a las recomendaciones del fabricante.
15. En caso de existir, una antena externa deberá ser localizada lejos de las lineas de energia.
16. El cable de corriente deberá ser desconectado del cuando el equipo no sea usado por un largo periodo de tiempo.
17. Cuidado debe ser tomado de tal manera que objetos liquidos no sean derramados sobre la cubierta u orificios de ventilación.

18. Servicio por personal calificado deberá ser provisto cuando:

A: El cable de poder o el contacto ha sido dañado; u

B: Objetos han caído o líquido ha sido derramado dentro del aparato; o

C: El aparato ha sido expuesto a la lluvia; o

D: El aparato parece no operar normalmente o muestra un cambio en su desempeño; o

E: El aparato ha sido tirado o su cubierta ha sido dañada.

SAFETY INFORMATION

WARNING: Never look directly into optical outputs or a fiber while the equipment is on. Invisible and visible laser beams may damage your eyes.

Do not short-circuit the AC adapter/charger terminal and the batteries. Excessive electrical current may cause personal injury due to fumes, electric shock, or equipment damage.

Connect the AC power cord to the equipment and wall socket properly. When you insert the AC plug, make sure there is no dust or dirt on the terminals and both plugs are fully seated.

WARNING: If the AC plug is not connected properly, fuming, electric shock, or equipment damage might occur and may result in personal injury.

Do not operate the equipment near hot objects, in hot environments, in dusty/humid atmospheres, or when condensation is present on the equipment. This may cause electric shock, product malfunction, or poor performance.

TRADEMARKS USED IN THIS MANUAL

Black Box and the Double Diamond logo are registered trademarks of BB Technologies, Inc.

Excel is a registered trademark of Microsoft Corporation.

Any other trademarks mentioned in this manual are acknowledged to be the property of the trademark owners.

1. Specifications	6
1.1 Optical Specifications.....	6
1.2 General Specifications	6
2. Overview.....	7
2.1 Introduction.....	7
2.2 What's Included	7
2.3 Features.....	7
3. Operation.....	8
3.1 Battery Indicator.....	8
3.2 AC Operation	9
4. Using the Deluxe Optical Power Meter with Memory.....	10
4.1 Display and Controls.....	10
4.1.1 Keypad.....	10
4.1.2 Connectors	11
4.1.3 LCD.....	12
4.2 Turning the Optical Power Meter On and Off.....	12
4.3 Setting the Wavelength.....	13
4.4 Switching Measurement Mode	13
4.5 Setting and Checking the Reference Level.....	14
4.6 Switching the LCD Backlighting On and Off.....	14
4.7 Frequency Detecting.....	14
4.8 Measured Power Value Overflow	15
4.9 Storing the Current Test Value.....	15
4.10 Checking the Storage Records	15
4.11 Connecting to the Optical Laser Source	16
5. Maintenance	17
Appendix. Troubleshooting	18
A.1 Calling Black Box	18
A.2 Shipping and Packaging.....	18

Deluxe Optical Power Meter with Memory

1. Specifications

1.1 Optical Specifications

NOTE: Valid at 1550 nm, CW. 23° C \pm 3° C, relative humidity less than or equal to 70% with FC connector.

Table 1-1. Optical Specifications

Function	Value
Auto Power-off	Yes
Backlighting	Yes
Calibrated Wavelength (nm)	850/1300/1310/1490/1550/1625
Data Storage	Yes
Detector Type	InGaAs
Frequency Detecting Range	-40 \pm 10 dBm
Measuring Range (dBm)	-70 \pm 10 @ 1550 nm
Operating Wavelength (nm)	800–1700
Precision	\pm 5% \pm 1
Reference Value	Yes
Resolution	0.01 dB
Tone Detection	270 Hz, 1 kHz, 2 kHz
USB Interface	Yes
Wavelength Detecting Range	-40 \pm 10 dBm
Wavelength Recognition	Yes

1.2 General Specifications

Connectors: FC/PC (SC/PC, ST/PC interchangeable connectors optional)

Temperature Tolerance: Operating: -10 to +50° C; Storage: -20 to +70° C

Humidity Tolerance: Less than 90%

Power: (2) 1.2-V Ni-MH batteries; AC adapter for continuous use

Size: 6.3"H x 3"W x 1.8"D (16 x 7.6 x 4.5 cm)

Weight: 0.59 lb. (0.27 kg)

2. Overview

2.1 Introduction

Use the Deluxe Optical Power Meter with Memory (FOPM-210) with an optical laser source (FOLS-SM-200 or FOLS-MM-200) to identify optical fiber strands, measure optical attenuation, verify continuity, and test optical transmission quality in laboratories, LANs, WANs, telecommunications networks, and other long-distance optical applications.

The FOPM-210 has a memory capacity of 1000 data items and supports data transfers via a USB port and the included software. The data can be saved as an Excel® file or plain text.

2.2 What's Included

Your package should include the following items. If anything is missing or damaged, contact Black Box Technical Support at 724-746-5500.

- Main Unit
- Quality Check Report
- Carrying Case
- AC/DC Adapter
- User's manual on CD-ROM
- Printed Quick Start Guide
- (2) 1.2-volt NiMH batteries
- Small Phillips screwdriver
- USB cable
- FC/PC connector (SC/PC, ST/PC interchangeable connector optional)

2.3 Features

- Small, compact unit is lightweight and is easy to carry
- Shifts units automatically, also has auto-off, power capacity display, and recharging display on the LCD
- Includes linear and logarithmic optical power display
- Has memory capacity of 1000 data points

3. Operation

3.1 Battery Indicator

A battery indicator on the screen shows the remaining charge. See Figures 3-1 and 3-2. Table 3-1 describes the LED status.

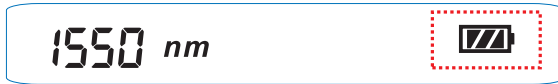





Figure 3-1. Battery indicator full.



Figure 3-2. Battery indicator empty.

Table 3-1. Battery indicator status.

Status	Icon	Description
Full		Battery at 100% capacity
2 Bars		Battery at 50–75% capacity
1 Bar		Battery at 25–50% capacity
Empty		Battery at 0–25% capacity The battery icon flashes when the power is almost depleted. Connect the AC adapter to the power meter to recharge the battery.

NOTES: To replace the batteries, use a screwdriver to remove the battery plate on the back of the power meter.

The AC indicator is not displayed when power is supplied by battery.

To eliminate the possibility of acid leakage, remove the battery if you won't use the power meter for an extended time.

3.2 AC Operation

If you will use the power meter at one location, for example, in a laboratory or test department, you can use the AC adapter to power it instead of batteries. Plug the AC adapter's output cable into the DC input jack on the bottom of the power meter. When the AC adapter is plugged in, the AC indicator on the LCD will be displayed. See Figure 3-3.

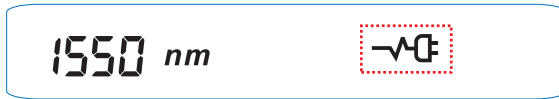

Figure 3-3. AC adapter indicator.

NOTES: Power is supplied by the AC adapter even if a battery is installed. The battery indicator does not display on the screen when AC adapter is plugged in.

Make sure that the AC adapter's operating voltage is within the range of the local AC voltage. For example, input: AC 100–240 V, 50–60 Hz.

Deluxe Optical Power Meter with Memory

4. Using the Deluxe Optical Power Meter with Memory

4.1 Display and Controls



Figure 4-1. Keypad functions: Number 1 through 6.

4.1.1 Keypad

Use the keypad to access a wide range of power meter functions. See Table 4-1.

Table 4-1. Keypad functions.







Number	Key	Function
1		Switches tester on/off. Press and hold for more than two seconds while turning on to disable the auto-off feature.
2		Press to set the wavelength. Select from six possible wavelengths: 850, 1300, 1310, 1490, 1550, and 1625 nm. Press and hold to activate auto-wavelength recognition.
3		Press to select the measurement mode. Three modes are available: dBm for the power value, dB for the relative value, and mw for the logarithmic value. (HI/LO will be displayed if the measured power value is out of range.)
4		Press to display the last record stored. Press and hold to store the current test value.
5		Press for less than two seconds to display the wavelength reference level. Press and hold for two more seconds to set a new wavelength reference level.

Table 4-1 (continued). Keypad functions.

Number	Key	Function
6		Press to switch backlighting on/off.

4.1.2 Connectors

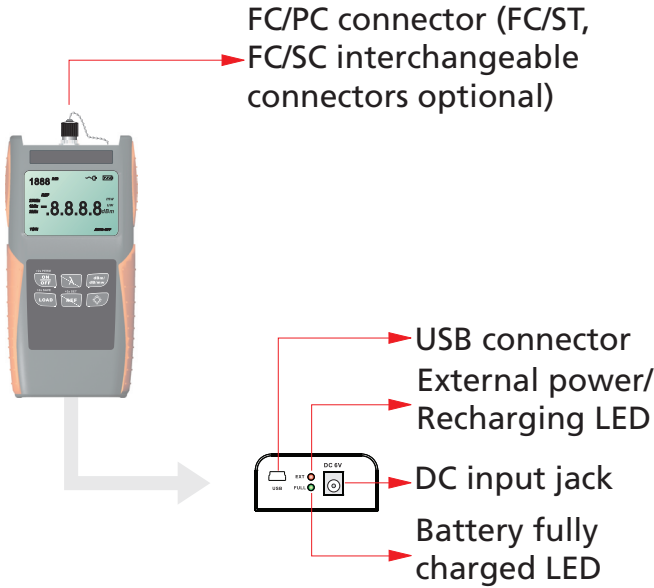

Figure 4-2. Deluxe Optical Power Meter with Memory, bottom view.

NOTE: The recharge LED lights when recharging batteries. The AC adapter LED lights when recharging finishes.

4.1.3 LCD

Wavelength

AC adapter

Reference
Frequency

Battery
indicator

Measurement
unit

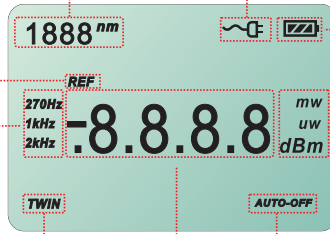

Auto-wavelength
recognition

Power Auto-off

Figure 4-3. LCD.

4.2 Turning the Optical Power Meter On and Off

1. Press the  key briefly. The power meter powers on, and backlighting switches on.

If the unit doesn't power on, check the battery charge and make sure the battery is connected properly. If the battery fails, contact Black Box Technical Support at 724-746-5500.



Figure 4-4. Powering on the power meter.

2. Press the  key briefly again. The instrument powers off, and backlighting switches off and the buzzer sounds briefly. When the battery capacity indicator flashes on the LCD, recharge the battery or install a new battery.

3. Turn on/off the auto-off function. The power meter powers off automatically if you do not press a key within 10 minutes. Press the  key for about two seconds to deactivate the auto-off function and the indicator will disappear on the LCD. The power meter powers off if the battery capacity is too low to support operation.

4.3 Setting the Wavelength

Press the  key repeatedly until the desired wavelength displays. Select from six possible wavelengths: 850, 1300, 1310, 1490, 1550, and 1625 nm. The default wavelength is 1550 nm.

The power meter defaults to the wavelength that you set in the last test.

When used with an optical laser source, the wavelength will shift according to the laser source's output wavelength. Press and hold the  key to activate auto-wavelength recognition.

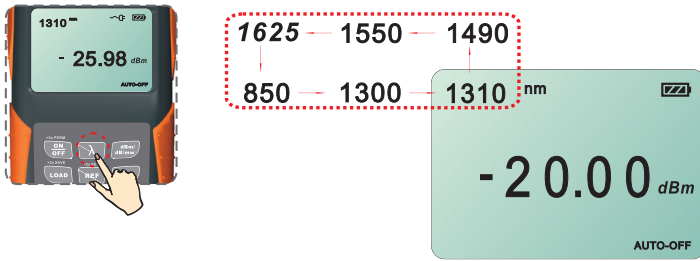



Figure 4-5. Press repeatedly to select the wavelength.





Figure 4-6. Press and hold to activate auto-wavelength recognition.

4.4 Switching Measurement Mode



Press the  key to select from three measurement modes: dBm for the power value, dB for the relative value, and mw for the logarithmic value.

Deluxe Optical Power Meter with Memory

4.5 Setting and Checking the Reference Level

1. Setting the reference level: Press and hold the  key for more than two seconds to store the presently measured value as the new reference level for the current wavelength. Once you set the new reference level, the LCD displays 0.00 dB, the buzzer sounds, and the power meter switches to dB measurement mode.
2. Checking the reference level: Press the  key to display the stored reference level for the current wavelength.  will be displayed on the LCD to indicate that it is a reference value. The reference value will only be displayed for about one second. The instrument then switches to the dB measurement mode.

4.6 Switching LCD Backlighting On and Off

1. Press the  key. Backlighting switches on.
2. Press the  key again. Backlighting switches off.

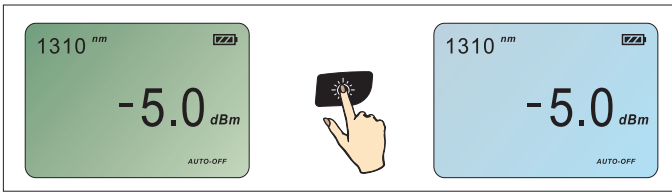

Figure 4-7. Turning ON/OFF backlighting.

4.7 Frequency Detecting

If the tested wavelength is carrying a tone of 270 Hz, 1 kHz, or 2 kHz, the frequency shows on the screen.

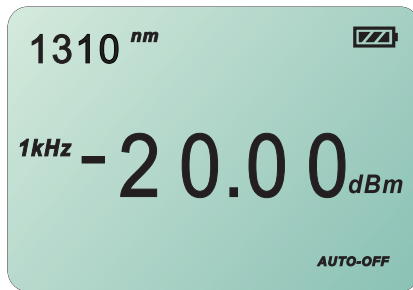

Figure 4-8. Frequency.

4.8 Measured Power Value Overflow

If the measured power value is higher than the highest value of the measuring range, the LCD screen displays HI.



Figure 4-9. Power value high.

If the measured power value is lower than the lowest value of the measuring range, the LCD screen displays LO.



Figure 4-10. Power value low.

4.9 Storing the Current Test Value

Press and hold the  key for more than two seconds. Save flashes on the LCD screen and the power meter buzzes. The LCD displays the stored value and storage serial number. The power meter returns to the test state automatically.

4.10 Checking the Storage Records

Press the  key to display the latest record.

Press the  key to browse forward through records.

Press the  key to browse backward through records.

Press the  and  keys to delete all records.



Figure 4-11. Checking storage records.

4.11 Connecting to the Optical Laser Source

When connected to the dual-wavelength laser source (FOLS-SM-200 or FOLS-MM-200), the Optical Power Meter (FOPM-210) accurately measures loss at distances up to 250 kilometers at 1550 nm. On-the-spot measurement will differ with the working wavelength, fiber attenuation, and the testing environment.

5. Maintenance

Disconnect the AC adapter/charger and replace the protective dust cap once you finish using it.

Clean the connector and the instrument when they get dirty from use. We recommend using optical cleaning pads and anhydrous alcohol. Be careful not to get liquid inside the instrument.

For measurement accuracy, calibrate the power meter once a year.

Appendix. Troubleshooting

A.1 Calling Black Box

If you determine that your Deluxe Optical Power Meter with Memory is malfunctioning, do not attempt to alter or repair the unit. It contains no user-serviceable parts. Contact Black Box Technical Support at 724-746-5500.

Before you do, make a record of the history of the problem. We will be able to provide more efficient and accurate assistance if you have a complete description, including:

- the nature and duration of the problem.
- when the problem occurs.
- the components involved in the problem.
- any particular application that, when used, appears to create the problem or make it worse.

A.2 Shipping and Packaging

If you need to transport or ship your Deluxe Optical Power Meter with Memory:

- Package it carefully. We recommend that you use the original container.
- If you are returning the unit, make sure you include everything you received with it. Before you ship for return or repair, contact Black Box to get a Return Authorization (RA) number.

Three-Year Limited Warranty

Products are warranted against defective components and workmanship for three years from the date of delivery to the original customer. Any product found to be defective within the warranty period can be returned to an authorized service center for repair, replacement, and calibration.

Exclusions

The warranty on your equipment does not apply to defects resulting from unauthorized repair or modification, misuse, negligence, or accident.

Black Box Tech Support: FREE! Live. 24/7.

Tech support the
way it should be.



Great tech support is just 20 seconds away at
724-746-5500 or blackbox.com.



About Black Box

Black Box Network Services is your source for more than 118,000 networking and infrastructure products. You'll find everything from cabinets and racks and power and surge protection products to media converters and Ethernet switches all supported by free, live 24/7 Tech support available in 20 seconds or less.

© Copyright 2009. All rights reserved.

724-746-5500 | blackbox.com