



# **MANUAL AND USER GUIDE**

## **SoundPlus™ TV Infrared System**

Model WIR 237

Model WIR 238

Model WIR 239

Transmitter Model WIR TX238  
Receiver Model WIR RX237 or  
Receiver Model WIR RX238 or  
Receiver Model WIR RX239

<u>CONTENTS</u>	<u>PAGE</u>
System Overview . . . . .	3
System Components . . . . .	3
Safety Information . . . . .	4
Recycling Instructions . . . . .	5
Operating Instructions . . . . .	6
WIR TX238 Transmitter . . . . .	6
WIR RX237 Receiver . . . . .	10
WIR RX238 Receiver . . . . .	13
WIR RX239 Receiver . . . . .	15
In Case of Difficulty . . . . .	17
Warranty . . . . .	18
System Specifications . . . . .	20

## SYSTEM OVERVIEW

Thank you for purchasing the SoundPlus™ TV Infrared System from Williams Sound Corp. Anyone needing auditory assistance to overcome background noise, reverberation, or distance from the sound source can benefit from the SoundPlus™ TV Infrared System.

You can use the SoundPlus™ TV Infrared System for hearing assistance in conference rooms, listening to the TV, or with other audio equipment. The TX238 Transmitter features an Automatic Level Control to adjust for different audio signal levels and to maintain a comfortable listening level.

**Please read through this manual carefully  
for proper setup and installation instructions.**

**NOTE: The SoundPlus™ TV Infrared System is not recommended for use with a PLASMA TV MONITOR.**

**If you have problems at anytime with these systems, do not hesitate to call us toll-free at 1-800-843-3544.**

## SYSTEM COMPONENTS

- WIR TX238 Transmitter
- Power Supply
- TV Microphone (MIC 084)
- WIR RX237 or WIR RX238 or WIR RX239 Receiver
- 1m Audio Cable with dual RCA plugs (WCA 078)
- Two Rechargeable Batteries (BAT AP97A)

## SAFETY INFORMATION

### Hearing Safety:

---



This product is designed to amplify sounds to a high volume level which could potentially cause hearing damage if used improperly.

### **To protect your hearing and the hearing of others:**

1. Make sure the volume is turned down before putting on the earphone or headphone before adjusting the volume to a comfortable level.
2. Set the volume level at the minimum setting that you need to hear.
3. If you experience feedback (a squealing or howling sound), reduce the volume setting and move the microphone away from the earphone or headphone.
4. Do not allow children **or other unauthorized persons** to have access to this product.

## Pacemaker Safety:

---



1. Before using this product with a pacemaker or other medical device, consult your physician or the manufacturer of your pacemaker or other medical device.
2. If you have a pacemaker or other medical device, make sure that you are using this product in accordance with safety guidelines established by your physician or the pacemaker manufacturer.

## RECYCLING INSTRUCTIONS

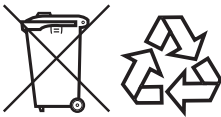

Help Williams Sound protect the environment! Please take the time to dispose of your equipment properly.

### **Product Recycling for Customers in the European Union:**

Please do NOT dispose of your Williams Sound equipment in the household trash. Please take the equipment to an electronics recycling center; OR, return the product to the factory for proper disposal.

### **Battery Recycling for Customers in the European Union:**

Please do NOT dispose of used batteries in the household trash. Please take the batteries to a retail or community collection point for recycling.

04/04/07

## SETTING UP THE TX238 TRANSMITTER

**NOTICE: THE RECHARGEABLE BATTERIES ARE SHIPPED IN A DISCHARGED STATE. THE BATTERIES MUST BE CHARGED OVERNIGHT BEFORE USING THE SOUNDPLUS™ TV INFRARED SYSTEM.**

The WIR TX238 Transmitter may be placed on top of a TV or shelf. Place the TX238 Transmitter where it is clearly visible from your listening position.

Infrared light behaves like visible light, so it is blocked by solid objects. This confines the signal to the room where the transmitter is located. The transmitter cannot be placed inside or behind anything except glass. The maximum operating distance is approximately 30 feet (9 m).

Ideally, the TX238 Transmitter should be at ear-level height or above. The infrared light pattern is much like a floodlight “cone” as it leaves the transmitter, with the best reception inside the cone.

Sunlight can cause infrared interference in the form of a buzz, hiss, or static. Thus, the system cannot be used outdoors and may not work properly inside if a lot of direct sunlight is present. Closing drapes or blinds will help if sunlight is a problem.

Any number of receivers may be used with the TX238 Transmitter, but use only one transmitter in a room at the same time. Otherwise, interference will occur.

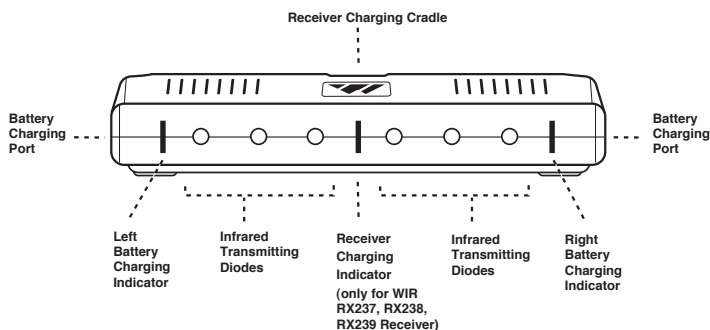

- ⑤ **TV Microphone**  
 If an RCA connection is unavailable, use the provided TV microphone to pick up the sound source directly from the TV loud speaker as shown on right.

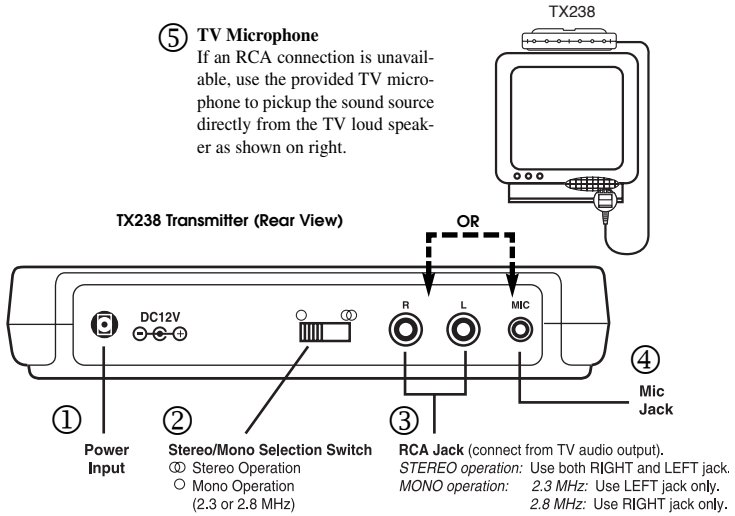

**STEP 1: CONNECT THE TRANSMITTER POWER SUPPLY**

Plug the Power Supply cord into the “DC 12V” jack ① on the back of the TX238. Then plug the Power Supply into an AC outlet. When the receiver is placed into the charging cradle built into the top of the transmitter, the center charging indicator on the front of the TX238 will turn on. When the spare battery is plugged into the left or right battery charging port on the transmitter, the corresponding charge indicator light will turn on.

**STEP 2: CONNECT THE TRANSMITTER TO THE AUDIO SOURCE**

Use the supplied red and white RCA audio cables to connect the TX238 Transmitter directly to the TV, VCR, or stereo “AUDIO OUT” jacks. If your television does not have “AUDIO OUT” jacks, you will need use the supplied TV microphone. See page 9 for TV microphone instructions.

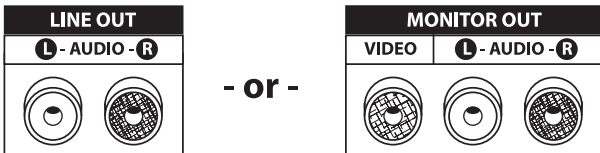

## STEP 2 (CONTINUED):

NOTE: Some televisions have **FIXED** output and others have **VARIABLE** output. If available, **FIXED** output should be selected. Consult your television manual for more information. “Fixed” output means the volume on the television will *not* change when the volume is increased, decreased, or muted. “Variable” output means the volume on the television will change when it is increased, decreased, or muted. If variable output is the only output available on your television, we recommend using the supplied TV microphone. See page 9 for TV microphone instructions.

## STEP 3: SELECT STEREO OR MONO OPERATION

**Note:** Choose 1 of 3 transmitter setup options below and on page 9. Verify receiver compatibility on left.

**Important:** If your system is packaged with the **WIR RX239 (neckloop) Receiver**, you must setup the **WIR TX238 Transmitter to operate in 2.3 MHz (mono) mode**. See 2.3 MHz (mono) instructions on page 9. **The WIR RX239 (neckloop) Receiver will NOT work while the transmitter is in stereo or 2.8 MHz mode.**

If your system is packaged with the **WIR RX237 or WIR RX238 Receiver**, you can choose to operate the **WIR TX238** in stereo OR mono (2.3 or 2.8 MHz) operation. For the highest quality, **stereo** is the recommended mode of operation.

Compatible with:



RX237  
-or-



RX238

## **STEREO OPERATION:**

### **(HIGHEST AUDIO QUALITY)**

Connect the RCA plugs from the TV or VCR audio output into the **LEFT** and **RIGHT** RCA jacks on the TX238 Transmitter ③. Next, slide the stereo/mono switch ② on the TX238 Transmitter to the stereo “**Ⓞ**” position. Your transmitter is now set for stereo operation.



Compatible with:



RX237  
-or-



RX238  
-or-



RX239

### **2.3 MHz (MONO) OPERATION:**

Connect the LEFT RCA plug from the TV or VCR audio output into the LEFT RCA jack on the TX238 Transmitter ③ (the right jack should be left unplugged). Next, slide the stereo/mono switch to the “○” mono position ②. The transmitter is now set for 2.3 MHz operation.

Compatible with:



RX237  
-or-



RX238

### **2.8 MHz (MONO) OPERATION:**

Connect the LEFT RCA plug from the TV or VCR speaker output into the RIGHT RCA jack on the TX238 Transmitter ③ (the left jack should be left unplugged). Next, slide the stereo/mono switch ② to the “○” mono position. The transmitter is now set for 2.8 MHz operation.

### **STEP 3 (CONTINUED):**

*If an RCA connection is unavailable*, use the provided **TV MICROPHONE** ⑤ to pick up the desired sound source. Plug in the microphone into the Mic Jack on the rear of the TX238 Transmitter ④. Use the velcro strip supplied to attach the microphone near the loudspeaker ④ of your TV or stereo.

The microphone will allow you to play the TV at lower volume for other listeners and will pick up other important sounds like the telephone or doorbell ringing.

## SETTING UP THE RX237 RECEIVER



### STEP 1: INSTALL THE RECEIVER BATTERIES

Insert the rechargeable battery into the bottom of the RX237 Receiver (see page 12). Place the receiver into the charger cradle built into the top of the TX238 Transmitter and let charge overnight. The spare battery can be plugged into the charging port located on either side of the transmitter. By keeping the spare battery charged, you can easily swap batteries when the one in use runs out and always have a fresh battery ready. A fully charged battery will operate the receiver for approximately 6 hours depending on the volume setting. The battery should be changed when you notice the sound getting weak and noisy. The batteries may be left charging when not in use.

### STEP 2: USING THE WIR RX237 RECEIVER

The RX237 will automatically configure itself for stereo or mono (2.3 or 2.8 MHz) operation depending on the setup chosen for the TX238 Transmitter.

Before you use the system, double check to make sure the WIR TX238 Transmitter's power supply is plugged in. Make sure the TV, stereo, or audio source is turned ON. Make sure the receiver's battery is fully charged.

#### To Use the Receiver:

1. First, place the lanyard on the receiver around your neck.

**IMPORTANT: a dual detector infrared "eye" is located in the front of the receiver. Do not cover it up or you will lose reception. Make sure the "SOUND PLUS" lettering is facing away from you when you put the receiver on.**

2. Next, plug in an earphone, headphone, or neckloop with 3.5mm plug into the jack on the bottom of the RX237 receiver (see drawing on page 12). Note: The RX237 turns ON automatically when you plug in the earphone/headphone into the jack, and turns OFF when you remove the earphone/headphone from the jack.

3. Rotate the volume control to a comfortable listening level. Note: If you are using a neckloop with the RX237, turn the volume control to "2," or about half of full volume. Then, turn the switch on your hearing aid to the "T" position and adjust the volume to a comfortable listening level. If the sound is weak, increase the volume on the RX237 Receiver, then on your hearing aid.

**IMPORTANT:** When you are done using the RX237, remember to **UNPLUG** the earphone, headphone, or neckloop from the receiver's jack. The receiver will not turn off until the earphone/headphone is removed from the unit.

**Return the receiver to the charger when it is not in use!**

#### **ADDITIONAL RECEIVER ADJUSTMENTS**

**Balance Control:** Use a small screwdriver to adjust the loudness balance between the Left and Right Earphones. See page 12.

**Tone Controls:** Use a small screwdriver to adjust the tone for the left and right earphones. See page 12.

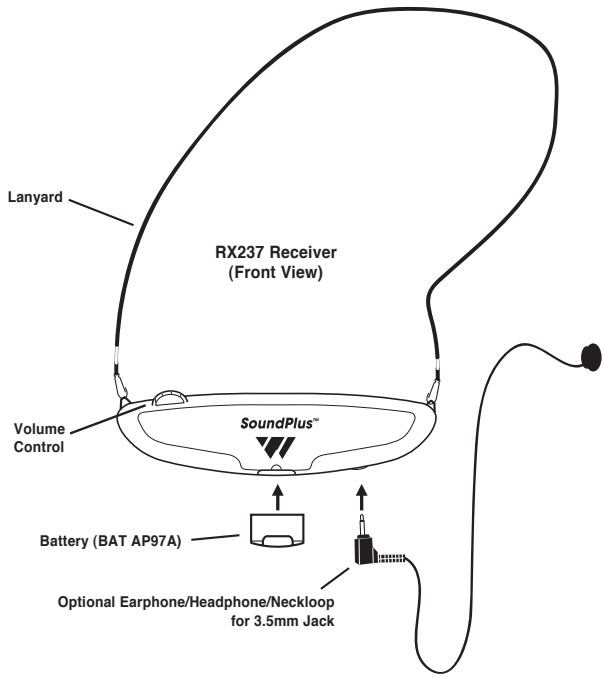

RX237 Receiver (Rear View)

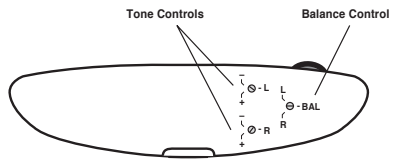

RX237 Receiver (Bottom View)

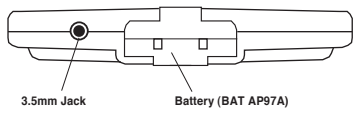

## SETTING UP THE RX238 RECEIVER



### STEP 1: INSTALL THE RECEIVER BATTERIES

Insert the rechargeable battery into the bottom of the RX238 Receiver (see page 14). Place the receiver into the charger cradle built into the top of the TX238 Transmitter and let charge overnight. The spare battery can be plugged into the charging port located on either side of the transmitter. By keeping the spare battery charged, you can easily swap batteries when the one in use runs out and always have a fresh battery ready. A fully charged battery will operate the receiver for approximately 6 hours, depending on the volume setting. The battery should be changed when you notice the sound getting weak and noisy. The batteries may be left charging when not in use.

### STEP 2: USING THE WIR RX238 RECEIVER

The RX238 will automatically configure itself for stereo or mono (2.3 or 2.8 MHz) operation depending on the setup chosen for the TX238 Transmitter.

To use the system, first check to make sure your TV or audio source is turned ON. Make sure the receiver battery is fully charged. The RX238 Receiver has an automatic on/off function. When you put the receiver on, it turns on. When you take the receiver off, it turns off. Rotate the volume control to adjust the volume to a comfortable level.

**IMPORTANT:** A dual detector infrared “eye” is located in the front of the receiver. Do not cover it up or you will lose reception. Make sure the “SOUND PLUS” lettering is facing away from you when you put the receiver on.

Return the receiver to the charger when it is not in use.

### ADDITIONAL RECEIVER ADJUSTMENTS

**Balance Control:** Use a small screwdriver to adjust the loudness balance between the left and right earphones. See page 14.

**Tone Controls:** Use a small screwdriver to adjust the tone for the left and right earphones. See page 14.

**Ear Cushions:** Replacement ear cushions are available from your Williams Sound dealer, part number EAR 031.

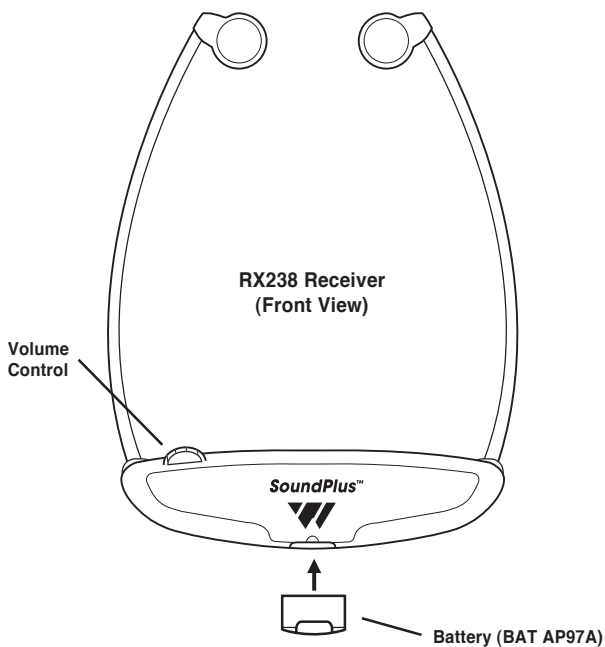

---

**RX238 Receiver (Rear View)**

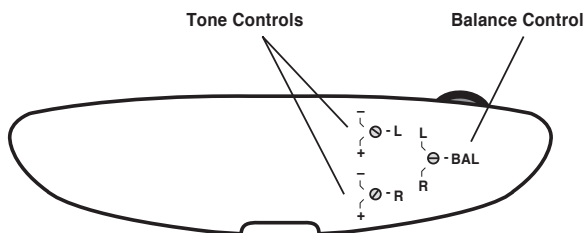

## SETTING UP THE RX239 (NECKLOOP) RECEIVER



### STEP 1: INSTALL THE RECEIVER BATTERIES

Insert the Rechargeable battery into the bottom of the RX239 Receiver (see drawing on page 16). Place the receiver into the charger cradle built into the top of the TX238 Transmitter and let charge overnight. The spare battery can be plugged into the charging port located on either side of the transmitter. By keeping the spare battery charged, you can easily swap batteries when the one in use runs out and always have a fresh battery ready. A fully charged battery will operate the receiver for approximately 6 hours, depending on the volume setting. The battery should be changed when you notice the sound getting weak and noisy. The batteries may be left charging when not in use.

### STEP 2: USING THE WIR RX239 RECEIVER

The RX239 Receiver magnetically transfers the audio from the TX238 Transmitter into a hearing aid equipped with a telephone coil (T-coil).

Before you use the receiver, double check to make sure the WIR TX238 Transmitter's power supply is plugged in. Make sure the audio connection on the transmitter is set up for **2.3 MHz** (mono) operation only. See pages 8-9. Make sure the TV, stereo, or audio source is turned ON. Make sure the receiver's battery is fully charged.

#### To use the Receiver:

1) First, place the neckloop on the receiver around your neck.

**Important: A dual detector infrared "eye" is located on the front of the receiver. Do not cover it up or you will lose reception. Make sure that "SOUNDPLUS" lettering is facing away from you when you put the receiver on.**

2) Turn the receiver ON by turning the volume control to "2," or about half of full volume.

3) Turn the switch on your hearing aid to the "T" position and adjust the volume for comfortable listening.

4) If the sound is weak, increase the volume on the Williams Sound unit, then on your hearing aid.

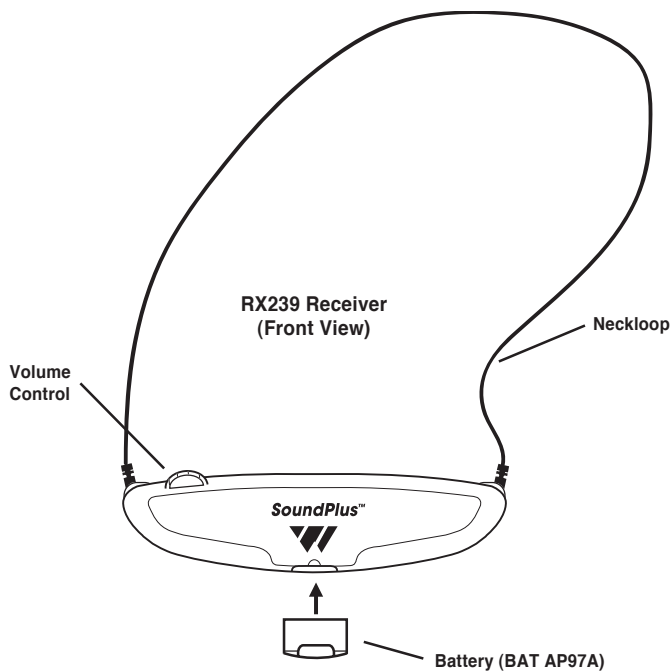

---

RX239 Receiver (Rear View)

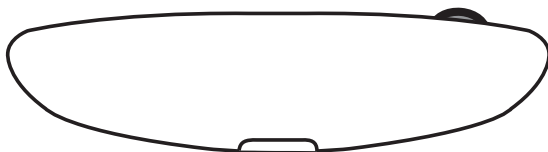



## IN CASE OF DIFFICULTY

If the system does not seem to be functioning:

1. Read through the manual and user guide carefully to verify proper setup and installation of your system.
2. Make sure that your television or VCR is plugged in and turned on.
3. Make sure that the TX238 Transmitter's power adapter is plugged in.
4. If you've installed the TX238 Transmitter other than on top of the TV, make sure that its front panel is facing the receiver.
5. Make sure that the receiver has a fully charged battery.
6. Make sure you are not covering the infrared "eye." Remove any objects obstructing the line between the TX238 Transmitter and the receiver. The "SoundPlus" label should be facing towards the TV while you listen.
7. If you are using the RX237 or RX238 Receiver and getting static or hiss: Try operating the TX238 Transmitter in MONO (2.3 MHz or 2.8 MHz) mode. See instructions on page 8.
8. If you are using the RX239 (neckloop) Receiver, and the sound is weak or noisy: First, make sure that the TX238 Transmitter is operating in 2.3 (Mono) mode. Also, check that the T-coil switch on your hearing aid is switched to the "On" position. Next, try increasing the volume on the receiver unit, then increase the volume on your hearing aid until the volume is at a comfortable listening level.
9. If you are operating the TX238 Transmitter in MONO (2.3 MHz or 2.8 MHz) mode and getting noise or hiss in the receiver: For 2.3 MHz operation, check to make sure you are only using the left RCA jack on the TX238 Transmitter. For 2.8 MHz operation: make sure you are only using the right RCA jack on the TX238 Transmitter.
10. If you are using the TV microphone and not getting a signal, try turning up the TV volume up slightly. Also, try positioning the TV mic directly over the TV speaker.
11. If the system still does not function, call Williams Sound at: 1-800-843-3544.

## LIMITED WARRANTY

Williams Sound products are engineered, designed and manufactured under carefully controlled conditions to provide you with many years of reliable service. Williams Sound warrants the SoundPlus™ TV Infrared System against defects in materials and workmanship for FIVE (5) years. During the first five years from the purchase date, we will promptly repair or replace the SoundPlus™ TV Infrared System.

Microphones, earphones, headphones, batteries, cables, carry cases, and all other accessory products carry a 90-day warranty. Chargers carry a one year warranty.

WILLIAMS SOUND HAS NO CONTROL OVER THE CONDITIONS UNDER WHICH THIS PRODUCT IS USED. WILLIAMS SOUND, THEREFORE, DISCLAIMS ALL WARRANTIES NOT SET FORTH ABOVE, BOTH EXPRESS AND IMPLIED, WITH RESPECT TO THE SOUNDPLUS™ TV INFRARED SYSTEM, INCLUDING BUT NOT LIMITED TO, ANY IMPLIED WARRANTY OF MERCHANTABILITY OR FITNESS FOR A PARTICULAR PURPOSE. WILLIAMS SOUND SHALL NOT BE LIABLE TO ANY PERSON OR ENTITY FOR ANY MEDICAL EXPENSES OR ANY DIRECT, INCIDENTAL OR CONSEQUENTIAL DAMAGES CAUSED BY ANY USE, DEFECT, FAILURE OR MALFUNCTION OF THE PRODUCT, WHETHER A CLAIM FOR SUCH DAMAGES IS BASED UPON WARRANTY, CONTRACT, TORT OR OTHERWISE. THE SOLE REMEDY FOR ANY DEFECT, FAILURE OR MALFUNCTION OF THE PRODUCT IS REPLACEMENT OF THE PRODUCT. NO PERSON HAS ANY AUTHORITY TO BIND WILLIAMS SOUND TO ANY REPRESENTATION OR WARRANTY WITH RESPECT TO THE SOUNDPLUS™ TV INFRARED SYSTEM. UNAUTHORIZED REPAIRS OR MODIFICATIONS WILL VOID THE WARRANTY.

The exclusions and limitations set out above are not intended to, and should not be construed so as to contravene mandatory provisions of applicable law. If any part or term of this Disclaimer of Warranty is held to be illegal, unenforceable or in conflict with applicable law by a court of competent jurisdiction, the validity of the remaining portions of this Disclaimer of Warranty shall not be affected, and all rights and obligations shall be construed and enforced as if this Limited Warranty did not contain the particular part or term held to be invalid.

If you experience difficulty with your system, call Toll-Free for Customer Assistance:

1-800-843-3544

If it is necessary to return the system for service, your Customer Service Representative will give you a Return Authorization Number (RA) and shipping instructions.

Pack the system carefully and send it to:

**Williams Sound Corp.**  
**Attn: Repair Dept.**  
**10321 West 70th Street**  
**Eden Prairie, MN 55344**

# WIR 238, WIR 239

## SYSTEM SPECIFICATIONS:

### WIR TX238 Transmitter:

---

Size, Weight, Color:	6.25”L x 3.25”W x 1.25”H (15.9cm x 8.3cm x 3.2cm), 5.1oz. (140g), Gray
Power Input:	12 VDC (center is positive), 200 mA Class II wall transformer TFP 024 Power Supply: North America: 120VAC, 60Hz, UL/CSA TFP 032 Power Supply, 2 pin Euro mains plug, 230VAC, 50-60 Hz, CE TFP 033 Power Supply, 3 pin UK mains plug, 230VAC, 50-60 Hz, CE
Subcarrier Frequency:	2.3 MHz, 2.8 MHz, or stereo.
Range:	30ft. (9m) line-of-site
Auto Power On/Off:	Transmitter shuts off infrared after 1.5 minutes when audio signal is removed. Battery charging functions remain on full time.
Microphone Input:	3.5 mm jack for MIC 084 Electret TV Microphone, 1.5 k $\Omega$
Line Inputs:	2 RCA jacks for mono or stereo line-level sources 200 mV min. to 10 V rms max. input level, 5.1 k $\Omega$
Automatic Level Control:	35 dB compression range
Infrared LEDs, Pattern:	8 IR LEDs, 45 degree cone-shaped coverage pattern to 6dB intensity, 30ft. (9m) line of sight
Charging Ports:	Charges one WIR RX238 Receiver plus two additional BAT AP97A NiMH battery packs
Approvals:	RoHS, WEEE
Warranty:	5 years*

\*90 days on cords, batteries, power supply and other accessories.

## **WIR RX237 Receiver:**

---

Weight:	1.7 oz (50 g) with battery
Material and Color:	ABS plastic, Black
Battery Type, Life:	BAT AP97A NiMH Battery Pack, 6 hours
Modulation Frequency:	2.3 and 2.8 MHz
Frequency Response:	200 Hz to 8 kHz, $\pm 5$ dB
Signal-to-Noise Ratio:	60 dB at 9m
Controls:	Volume control thumbwheel; screwdriver adjust balance and (L & R) tone controls
Acoustic Output:	115 dB MAX SSPL90 with EAR 013 (2cc coupler)
Compatibility:	Compatible with transmitters operating on 2.3 MHz/2.8 MHz
Power Switch:	Built into jack
Approvals:	RoHS, WEEE
Warranty:	5 years, parts and labor*

## **WIR RX238 Receiver:**

---

Weight:	2.1 oz (60 g) with batteries
Material and Color:	ABS plastic, Black and Grey
Battery Type, Life:	BAT AP97A NiMH Battery Pack, 6 hours
Modulation Frequency:	2.3 MHz and/or 2.8 MHz
Frequency Response:	200 Hz to 8 kHz, $\pm 5$ dB
Signal to Noise Ratio:	60 dB at 30 ft. (9m)
Controls:	Volume control thumbwheel; screwdriver adjust balance and (L & R) tone controls
Acoustic Output:	112 dB MAX SSPL90 with 2 cc coupler
Compatibility:	Compatible with transmitters operating on 2.3 MHz, 2.8 MHz, or both (stereo)
Power Switch:	Built into receiver "arms"
Ear pads:	Uses EAR 031 foam cushions
Approvals:	RoHS, WEEE
Warranty:	5 years*

\*90 days on cords, batteries, power supply and other accessories.

## **WIR RX239 Receiver:**

---

Weight:	2.2 oz (64 g) with batteries
Material and Color:	ABS plastic, Black
Battery Type, Life:	BAT AP97A NiMH Battery Pack, 6 hours
Modulation Frequency:	2.3 MHz
Frequency Response:	200 Hz to 8 kHz, $\pm 5$ dB
Signal to Noise Ratio:	60 dB at 30 ft. (9m)
Controls:	Volume control thumbwheel
Compatibility:	Compatible with most wide-band 2.3 MHz Transmitters
Power Switch:	Built into volume control
Loop Length:	32"
Approvals:	RoHS, WEEE
Warranty:	5 years*

\*90 days on cords, batteries, power supply and other accessories.





**WILLIAMS SOUND®**

*Helping People Hear*

10321 West 70th St., Eden Prairie, MN 55344 U.S.A.  
800.843.3544 | 952.943.2252 | FAX: 952.943.2174  
[www.williamssound.com](http://www.williamssound.com)

©2007 Williams Sound Corp. MAN 120C