

# ONKYO

AV RECEIVER

# HT-R391

## Instruction Manual

## Contents

[Safety Information and Introduction .....2](#)



[Table of Contents .....6](#)

[Connections .....12](#)

[Turning On & Basic Operations .....20](#)

[Advanced Operations .....37](#)

[Controlling Other Components .....48](#)

[Appendix .....54](#)

[Speaker Package](#)

Made for



iPod



iPhone



**WARNING:**

TO REDUCE THE RISK OF FIRE OR ELECTRIC SHOCK, DO NOT EXPOSE THIS APPARATUS TO RAIN OR MOISTURE.

**CAUTION:**

TO REDUCE THE RISK OF ELECTRIC SHOCK, DO NOT REMOVE COVER (OR BACK). NO USER-SERVICEABLE PARTS INSIDE. REFER SERVICING TO QUALIFIED SERVICE PERSONNEL.



The lightning flash with arrowhead symbol, within an equilateral triangle, is intended to alert the user to the presence of uninsulated “dangerous voltage” within the product’s enclosure that may be of sufficient magnitude to constitute a risk of electric shock to persons.



The exclamation point within an equilateral triangle is intended to alert the user to the presence of important operating and maintenance (servicing) instructions in the literature accompanying the appliance.



9. Do not defeat the safety purpose of the polarized or grounding-type plug. A polarized plug has two blades with one wider than the other. A grounding type plug has two blades and a third grounding prong. The wide blade or the third prong are provided for your safety. If the provided plug does not fit into your outlet, consult an electrician for replacement of the obsolete outlet.
10. Protect the power cord from being walked on or pinched particularly at plugs, convenience receptacles, and the point where they exit from the apparatus.
11. Only use attachments/accessories specified by the manufacturer.
12. Use only with the cart, stand, tripod, bracket, or table specified by the manufacturer, or sold with the apparatus. When a cart is used, use caution when moving the cart/apparatus combination to avoid injury from tip-over.
13. Unplug this apparatus during lightning storms or when unused for long periods of time.
14. Refer all servicing to qualified service personnel. Servicing is required when the apparatus has been damaged in any way, such as power-supply cord or plug is damaged, liquid has been spilled or objects have fallen into the apparatus, the apparatus has been exposed to rain or moisture, does not operate normally, or has been dropped.
15. Damage Requiring Service
  - A. Unplug the apparatus from the wall outlet and refer servicing to qualified service personnel under the following conditions:
    - A. When the power-supply cord or plug is damaged,
    - B. If liquid has been spilled, or objects have fallen into the apparatus,
    - C. If the apparatus has been exposed to rain or water,

PORTABLE CART WARNING



- D. If the apparatus does not operate normally by following the operating instructions. Adjust only those controls that are covered by the operating instructions as an improper adjustment of other controls may result in damage and will often require extensive work by a qualified technician to restore the apparatus to its normal operation,
  - E. If the apparatus has been dropped or damaged in any way, and
  - F. When the apparatus exhibits a distinct change in performance this indicates a need for service.
16. Object and Liquid Entry  
Never push objects of any kind into the apparatus through openings as they may touch dangerous voltage points or short-out parts that could result in a fire or electric shock.  
The apparatus shall not be exposed to dripping or splashing and no objects filled with liquids, such as vases shall be placed on the apparatus.  
Don't put candles or other burning objects on top of this unit.
17. Batteries  
Always consider the environmental issues and follow local regulations when disposing of batteries.
18. If you install the apparatus in a built-in installation, such as a bookcase or rack, ensure that there is adequate ventilation.  
Leave 20 cm (8") of free space at the top and sides and 10 cm (4") at the rear. The rear edge of the shelf or board above the apparatus shall be set 10 cm (4") away from the rear panel or wall, creating a flue-like gap for warm air to escape.  
The temperature protection operates if the apparatus attain an abnormal high temperature.  
The apparatus cannot operate until it has cooled down.

**Important Safety Instructions**

1. Read these instructions.
2. Keep these instructions.
3. Heed all warnings.
4. Follow all instructions.
5. Do not use this apparatus near water.
6. Clean only with dry cloth.
7. Do not block any ventilation openings. Install in accordance with the manufacturer's instructions.
8. Do not install near any heat sources such as radiators, heat registers, stoves, or other apparatus (including amplifiers) that produce heat.



# Precautions

1. **Recording Copyright**—Unless it's for personal use only, recording copyrighted material is illegal without the permission of the copyright holder.
2. **AC Fuse**—The AC fuse inside the unit is not user-serviceable. If you cannot turn on the unit, contact your Onkyo dealer.
3. **Care**—Occasionally you should dust the unit all over with a soft cloth. For stubborn stains, use a soft cloth dampened with a weak solution of mild detergent and water. Dry the unit immediately afterwards with a clean cloth. Don't use abrasive cloths, thinners, alcohol, or other chemical solvents, because they may damage the finish or remove the panel lettering.
4. **Power**

## WARNING

BEFORE PLUGGING IN THE UNIT FOR THE FIRST TIME, READ THE FOLLOWING SECTION CAREFULLY.

AC outlet voltages vary from country to country. Make sure that the voltage in your area meets the voltage requirements printed on the unit's rear panel (e.g., AC 230 V, 50 Hz or AC 120 V, 60 Hz).

The power cord plug is used to disconnect this unit from the AC power source. Make sure that the plug is readily operable (easily accessible) at all times.

For models with [POWER] button, or with both [POWER] and [ON/STANDBY] buttons:

Pressing the [POWER] button to select OFF mode does not fully disconnect from the mains. If you do not intend to use the unit for an extended period, remove the power cord from the AC outlet.

For models with [ON/STANDBY] button only:

Pressing the [ON/STANDBY] button to select Standby mode does not fully disconnect from the mains. If you do not intend to use the unit for an extended period, remove the power cord from the AC outlet.

## 5. Preventing Hearing Loss

### Caution

Excessive sound pressure from earphones and headphones can cause hearing loss.

## 6. Batteries and Heat Exposure

### Warning

Batteries (battery pack or batteries installed) shall not be exposed to excessive heat as sunshine, fire or the like.

## 7. Never Touch this Unit with Wet Hands

—Never handle this unit or its power cord while your hands are wet or damp. If water or any other liquid gets inside this unit, have it checked by your Onkyo dealer.

## 8. Handling Notes

- If you need to transport this unit, use the original packaging to pack it how it was when you originally bought it.
- Do not leave rubber or plastic items on this unit for a long time, because they may leave marks on the case.
- This unit's top and rear panels may get warm after prolonged use. This is normal.
- If you do not use this unit for a long time, it may not work properly the next time you turn it on, so be sure to use it occasionally.

## For U.S. models

### FCC Information for User

#### CAUTION:

The user changes or modifications not expressly approved by the party responsible for compliance could void the user's authority to operate the equipment.

#### NOTE:

This equipment has been tested and found to comply with the limits for a Class B digital device, pursuant to Part 15 of the FCC Rules. These limits are designed to provide reasonable protection against harmful interference in a residential installation.

This equipment generates, uses and can radiate radio frequency energy and, if not installed and used in accordance with the instructions, may cause harmful interference to radio communications. However, there is no guarantee that interference will not occur in a particular installation. If this equipment does cause harmful interference to radio or television reception, which can be determined by turning the equipment off and on, the user is encouraged to try to correct the interference by one or more of the following measures:

- Reorient or relocate the receiving antenna.
- Increase the separation between the equipment and receiver.
- Connect the equipment into an outlet on a circuit different from that to which the receiver is connected.
- Consult the dealer or an experienced radio/TV technician for help.



## For Canadian Models

**NOTE:** THIS CLASS B DIGITAL APPARATUS  
COMPLIES WITH CANADIAN ICES-003.

For models having a power cord with a polarized plug:

**CAUTION:** TO PREVENT ELECTRIC SHOCK,  
MATCH WIDE BLADE OF PLUG TO WIDE SLOT,  
FULLY INSERT.

## Modèle pour les Canadien

**REMARQUE:** CET APPAREIL NUMÉRIQUE DE LA  
CLASSE B EST CONFORME À LA NORME NMB-003  
DU CANADA.

Sur les modèles dont la fiche est polarisée:

**ATTENTION:** POUR ÉVITER LES CHOCS  
ÉLECTRIQUES, INTRODUIRE LA LAME LA PLUS  
LARGE DE LA FICHE DANS LA BORNE  
CORRESPONDANTE DE LA PRISE ET POUSSER  
JUSQU' AU FOND.

# Supplied Accessories

Make sure you have the following accessories:

**Indoor FM antenna** (→ [page 19](#))

**AM loop antenna** (→ [page 19](#))

**Power cord (Brazilian models)** (→ [page 19](#))

**Remote controller (RC-799M) and two batteries (AA/R6)**

**Quick Start Guide**

\* In catalogs and on packaging, the letter at the end of the product name indicates the color. Specifications and operations are the same regardless of color.

## ■ Installing the batteries

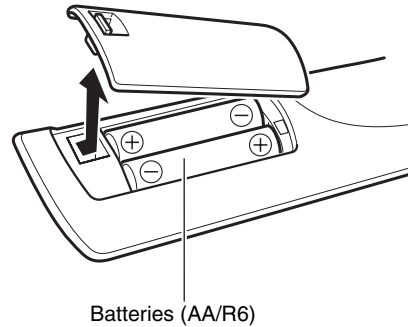

### Note

- If the remote controller doesn't work reliably, try replacing the batteries.
- Don't mix new and old batteries or different types of batteries.
- If you intend not to use the remote controller for a long time, remove the batteries to prevent damage from leakage or corrosion.
- Remove expired batteries as soon as possible to prevent damage from leakage or corrosion.

## ■ Aiming the remote controller

To use the remote controller, point it at the AV receiver's remote control sensor, as shown below.

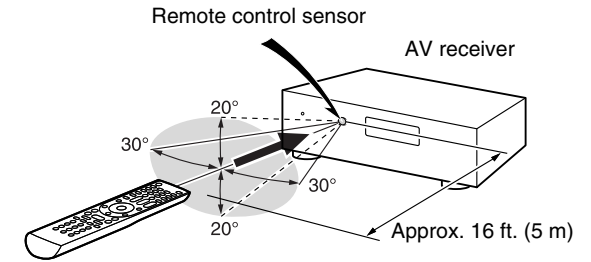

Thank you for purchasing an Onkyo AV Receiver. Please read this manual thoroughly before making connections and plugging in the unit. Following the instructions in this manual will enable you to obtain optimum performance and listening enjoyment from your new AV Receiver. Please retain this manual for future reference.

# Table of Contents

## Safety Information and Introduction

Important Safety Instructions .....	2
Precautions .....	3
Supplied Accessories.....	5
Table of Contents.....	6
Features .....	7
Front & Rear Panels.....	8
Front Panel.....	8
Display .....	9
Rear Panel .....	10
Remote Controller.....	11
Controlling the AV Receiver .....	11

## Connections

Connecting the AV Receiver .....	12
Connecting Your Speakers .....	12
About AV Connections .....	15
Connecting Components with HDMI .....	16
Connecting Your Components .....	17
Connecting Onkyo <b>RI</b> Components .....	18
Connecting a Recording Component .....	18
Connecting the Antennas.....	19
Connecting the Power Cord.....	19

## Turning On & Basic Operations

Turning On/Off the AV Receiver .....	20
Turning On .....	20
Turning Off .....	20
Playback .....	21
Playing the Connected Component .....	21
Controlling Contents of USB Devices .....	22
Understanding Icons on the Display .....	23
Playing an iPod/iPhone via USB .....	23
Playing a USB Device .....	24
Listening to AM/FM Radio.....	25

Using Basic Functions .....	28
Using the Listening Modes .....	28
Using the Home Menu .....	33
Selecting Speakers A and B .....	33
Using the Sleep Timer .....	34
Setting the Display Brightness .....	34
Displaying Source Information .....	34
Changing the Input Display .....	35
Using the Music Optimizer .....	35
Muting the AV Receiver .....	35
Using Headphones .....	36
Recording .....	36

## Advanced Operations

On-screen Setup.....	37
Common Procedures in Setup Menu.....	37
Setup menu items .....	38
HDMI Input.....	39
Component (Component Video Input) .....	39
Digital Audio (Digital Audio Input) .....	40
Sp Config (Speaker Configuration).....	40
Sp Distance (Speaker Distance).....	41
Level Cal (Level Calibration).....	41
Audio Adjust.....	42
Source Setup .....	43
Hardware .....	44
HDMI Setup .....	45
Using the Audio Settings .....	46

## Controlling Other Components

iPod/iPhone Playback via Onkyo Dock .....	48
Using the Onkyo Dock .....	48
Controlling Your iPod/iPhone.....	49
Controlling Other Onkyo Components.....	50
Preprogrammed Remote Control Codes .....	50
Entering Remote Control Codes.....	50
Remote Control Codes for Onkyo Components	
Connected via <b>RI</b> .....	50
Resetting the REMOTE MODE Buttons .....	51
Resetting the Remote Controller .....	51
Controlling Other Components .....	52

## Appendix

Troubleshooting .....	54
Connection Tips and Video Signal Path .....	59
Using an RIHD-compatible TV, Player, or Recorder .....	60
About HDMI .....	62
USB Features.....	63
License and Trademark Information .....	64
Specifications .....	65

To reset the AV receiver to its factory defaults, turn it on and, while holding down **VCR/DVR**, press **ON/STANDBY** (→ [page 54](#)).



# Features

## Amplifier

---

- 110 Watts/Channel @ 6 ohms (FTC)
- 100 Watts/Channel @ 6 ohms (IEC)
- 120 Watts/Channel @ 6 ohms (JEITA)
- Optimum Gain Volume Circuitry
- H.C.P.S. (High Current Power Supply) Massive High Power Transformer

## Processing

---

- HDMI (Audio Return Channel, 3D, DeepColor, x.v.Color, Lip Sync, DTS-HD Master Audio, DTS-HD High Resolution Audio, Dolby TrueHD, Dolby Digital Plus, DSD and Multi-CH PCM)
- Non-Scaling Configuration
- A-Form Listening Mode Memory
- Direct Mode
- Music Optimizer for Compressed Digital Music files
- 192 kHz/24-bit D/A Converters
- Powerful and Highly Accurate 32-bit Processing DSP
- Jitter Cleaning Circuit Technology

## Connections

---

- 4 HDMI Inputs and 1 Output
- Onkyo **RIHD** for System Control
- 3 Digital Inputs (2 Optical/1 Coaxial)
- Component Video Switching (2 Inputs/1 Output)
- Front-Panel USB Input for Memory Devices and iPod®/iPhone® models

## Miscellaneous

---

- 40 FM/AM Presets
- EX.BASS for natural deeper bass
- Crossover Adjustment (40/50/60/70/80/90/100/120/150/200 Hz)
- A/V Sync Control Function (up to 400 ms)
- Auto Standby Function
- On-Screen Display via HDMI

# Front & Rear Panels

## Front Panel

(North American and Brazilian models)

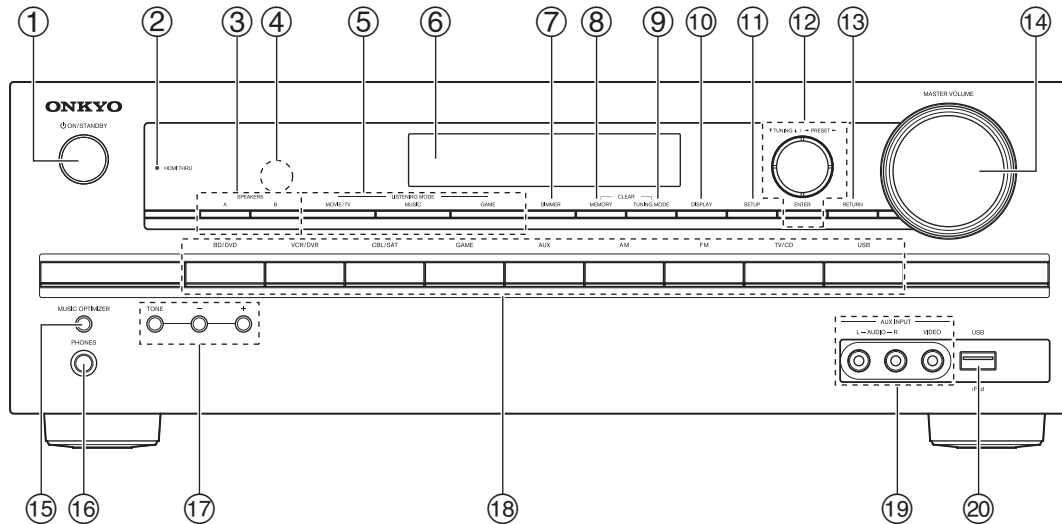

For detailed information, see the pages in parentheses.

- ① **ON/STANDBY** button (20)
- ② **HDMI THRU** indicator (45)
- ③ **SPEAKERS A and B** buttons (33)
- ④ **Remote control sensor** (5)
- ⑤ **LISTENING MODE** buttons (28)
- ⑥ **Display** (9)
- ⑦ **DIMMER** button (North American and Brazilian models) (34)
- ⑧ **MEMORY** button (26)
- ⑨ **TUNING MODE** button (25)

- ⑩ **DISPLAY** button (34)
- ⑪ **SETUP** button (37)
- ⑫ **TUNING ▲/▼, PRESET ◀/▶** (25), cursor and **ENTER** buttons
- ⑬ **RETURN** button
- ⑭ **MASTER VOLUME** control (21)
- ⑮ **MUSIC OPTIMIZER** button (35, 47)
- ⑯ **PHONES** jack (36)
- ⑰ **TONE** and **Level** buttons (46)
- ⑱ **Input selector** buttons (21)
- ⑲ **AUX INPUT AUDIO** and **VIDEO** jacks (17)

(Asian models)

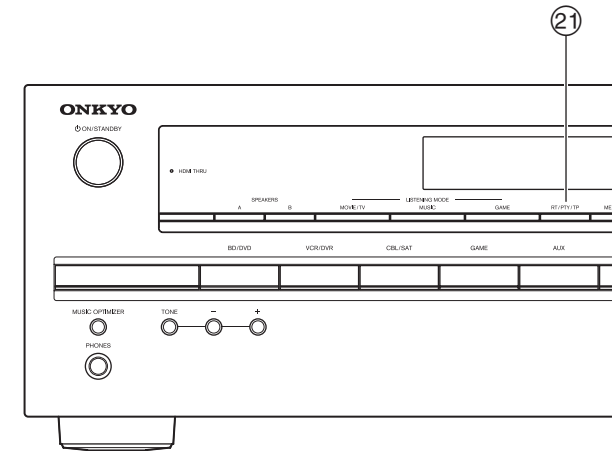

- ⑳ **USB** port (17)
- ㉑ **RT/PTY/TP** button (Asian models) (26)





## Display

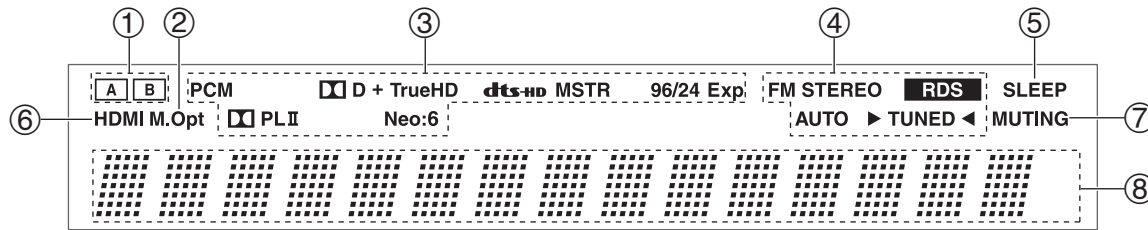

For detailed information, see the pages in parentheses.

- ① **A and B speaker indicators** (33)
- ② **M.Opt indicator** (35, 47)
- ③ **Listening mode and format indicators** (28, 44)
- ④ **Tuning indicators**
  - RDS indicator (excluding North American and Brazilian models) (26)
  - AUTO indicator (25)
  - TUNED indicator (25)
  - FM STEREO indicator (25)
- ⑤ **SLEEP indicator** (34)
- ⑥ **HDMI indicator** (45, 59)
- ⑦ **MUTING indicator** (35)
- ⑧ **Message area**

## Rear Panel

(North American and Asian models)

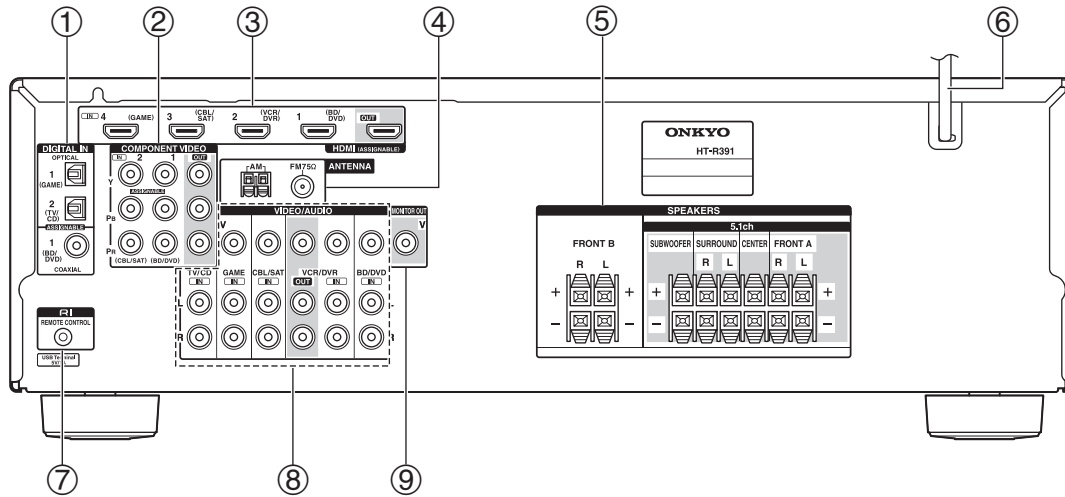

- ① **DIGITAL IN COAXIAL and OPTICAL** jacks
- ② **COMPONENT VIDEO IN and OUT** jacks
- ③ **HDMI IN and OUT** jacks
- ④ **FM ANTENNA** jack and **AM ANTENNA** terminal
- ⑤ **SPEAKERS** terminals  
(FRONT A, CENTER, SURROUND, SUBWOOFER, FRONT B)
- ⑥ **Power cord** (North American and Asian models)
- ⑦ **RI REMOTE CONTROL** jack

- ⑧ **Composite video and analog audio jacks**  
(BD/DVD IN, VCR/DVR IN and OUT, CBL/SAT IN, GAME IN, TV/CD IN)
- ⑨ **MONITOR OUT V** jack
- ⑩ **AC INLET** (Brazilian models)

See “Connecting the AV Receiver” for connection  
(→ [pages 12 to 19](#)).

(Brazilian models)

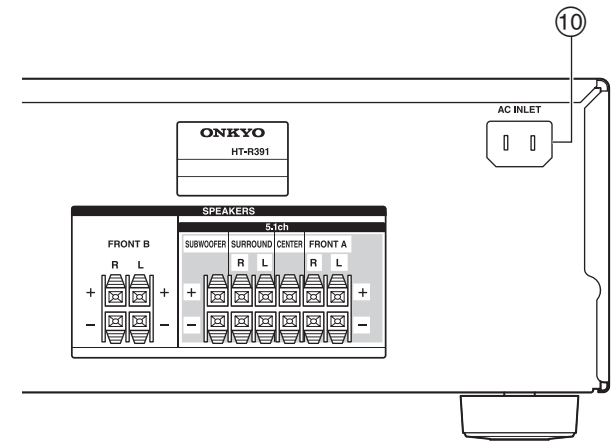

# Remote Controller

## Controlling the AV Receiver

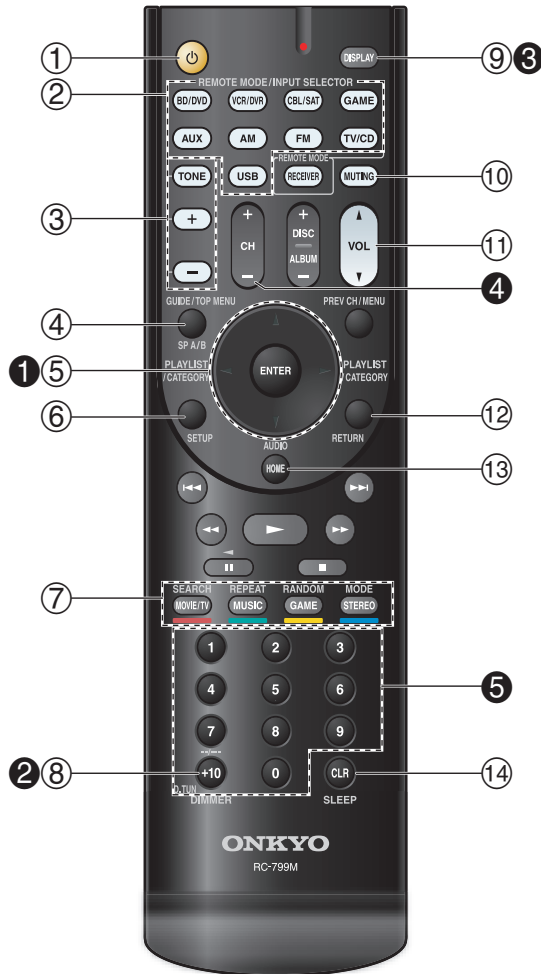

To control the AV receiver, press **RECEIVER** to select Receiver mode.  
 You can also use the remote controller to control Onkyo Blu-ray Disc/DVD player, CD player, and other components.  
 See “Entering Remote Control Codes” for more details (→ page 50).

- For detailed information, see the pages in parentheses.
- ① **Power button (20)**
  - ② **REMOTE MODE/INPUT SELECTOR buttons (21)**
  - ③ **TONE and Level buttons (46)**
  - ④ **SP A/B button (33)**
  - ⑤ **▲/▼/◀/▶ and ENTER buttons**
  - ⑥ **SETUP button (37)**
  - ⑦ **Listening Mode buttons (28)**
  - ⑧ **DIMMER button (34)**
  - ⑨ **DISPLAY button (34)**
  - ⑩ **MUTING button (35)**
  - ⑪ **VOL ▲/▼ button (21)**
  - ⑫ **RETURN button**
  - ⑬ **HOME button (33)**
  - ⑭ **SLEEP button (34)**

- **Controlling the tuner**  
 To control the AV receiver’s tuner, press **AM** or **FM** (or **RECEIVER**).
- ① **▲/▼ buttons (25)**
  - ② **D.TUN button (25)**
  - ③ **DISPLAY button**
  - ④ **CH +/- button (26)**
  - ⑤ **Number buttons (25)**



# Connecting the AV Receiver

## Connecting Your Speakers

### Connecting the Speaker Cables

The following illustration shows how to connect the speakers to each pair of terminals.

#### ■ Using a Passive Subwoofer

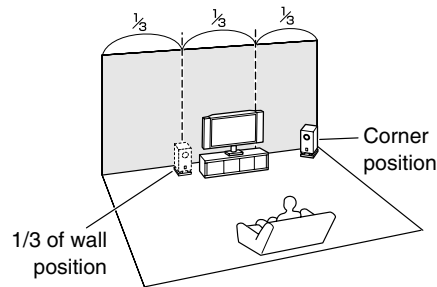

To find the best position for your subwoofer, while playing a movie or some music with good bass, experiment by placing your subwoofer at various positions within the room, and choose the one that provides the most satisfying results.

#### ■ Push-type speaker terminals

Strip 3/8" to 1/2" (10 to 12 mm) of insulation from the ends of the speaker cables, and twist the bare wires tightly, as shown (Supplied speaker cables are already stripped).

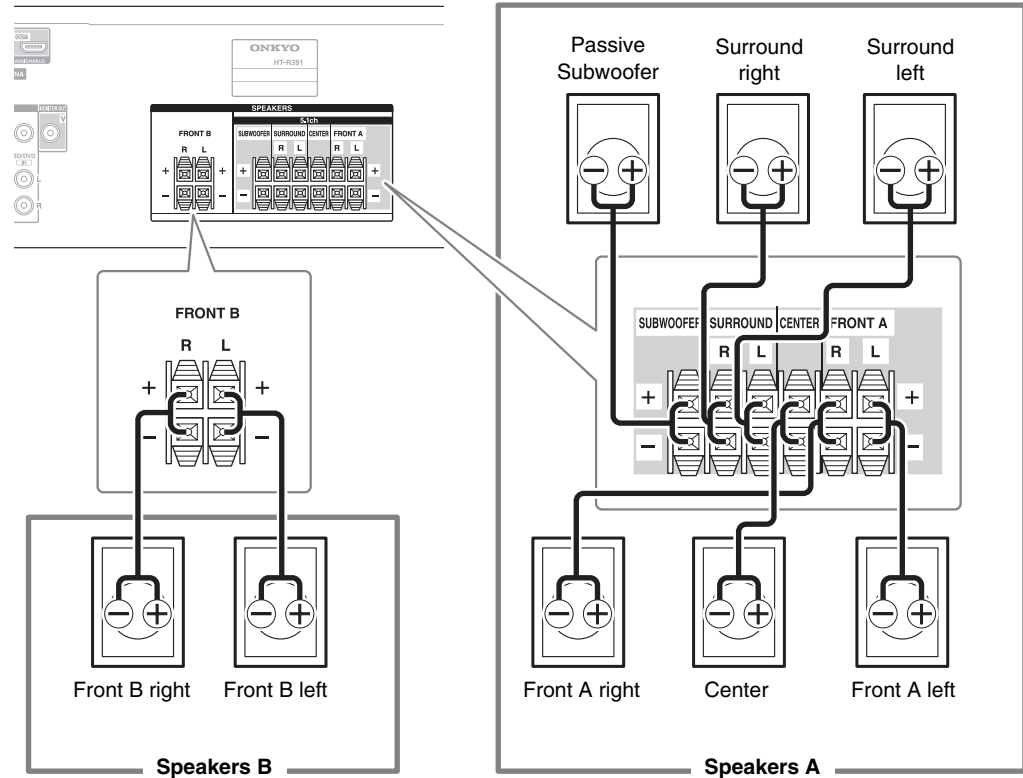
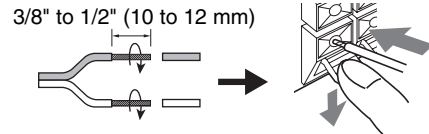

## Speaker Configuration

The following table indicates the channels you should use depending on the number of speakers that you have.

No matter how many speakers you use, a passive subwoofer is recommended for a really powerful and solid bass.

To get the best from your surround sound system, you need to set the speaker settings manually (→ [page 40](#)).

Number of speakers	2	3	4	5
Front speakers	✓	✓	✓	✓
Center speaker		✓		✓
Surround speakers			✓	✓

## Connecting the Speaker Cables

The speaker terminals are color-coded for identification purpose.

Speaker	Color
Front left	White
Front right	Red
Center	Green
Surround left	Blue
Surround right	Gray
Subwoofer	Purple

## Speaker Connection Precautions

Read the following before connecting your speakers:

- You can connect speakers with an impedance of between 6 and 16 ohms. If you use speakers with a lower impedance, and use the amplifier at high volume levels for a long period of time, the built-in amp protection circuit may be activated.
- Disconnect the power cord from the wall outlet before making any connections.
- Read the instructions supplied with your speakers.
- Pay close attention to speaker wiring polarity. In other words, connect positive (+) terminals only to positive (+) terminals, and negative (–) terminals only to negative (–) terminals. If you get them the wrong way around, the sound will be out of phase and will sound unnatural.
- Unnecessarily long, or very thin speaker cables may affect the sound quality and should be avoided.
- Be careful not to short the positive and negative wires. Doing so may damage the AV receiver.
- Make sure the metal core of the wire does not have contact with the AV receiver's rear panel. Doing so may damage the AV receiver.

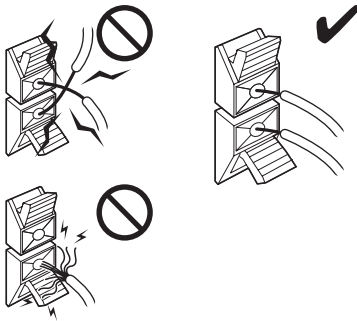
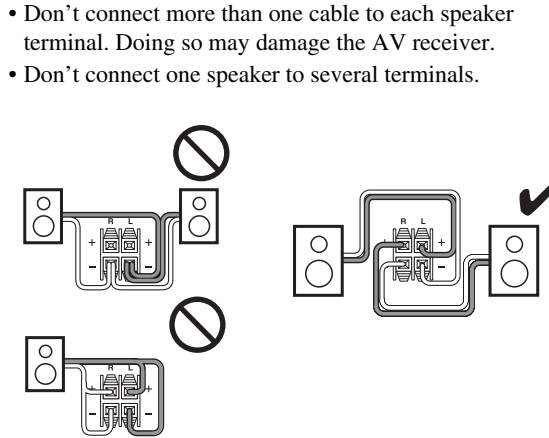

## About AV Connections

### Connecting AV components

#### HDMI cable

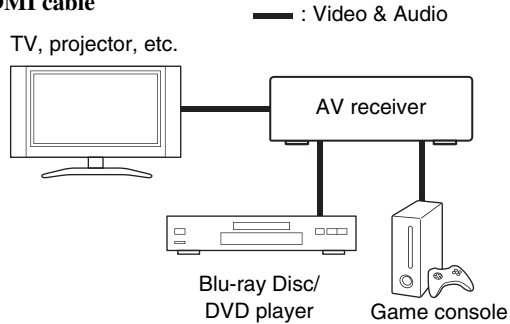

#### Other cables

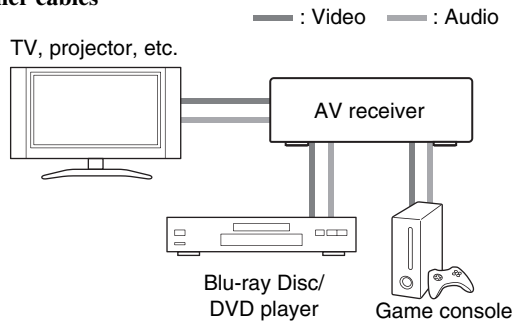

- Before making any AV connections, read the manuals supplied with your AV components.
- Don't connect the power cord until you've completed and double-checked all AV connections.
- Push plugs in all the way to make good connections (loose connections can cause noise or malfunctions).
- To prevent interference, keep audio and video cables away from power cords and speaker cables.

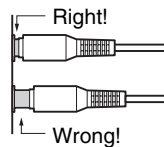

### AV Cables and Jacks

#### HDMI

HDMI connections can carry digital video and audio.



#### Component video

Component video separates the luminance (Y) and color difference signals (Pb, Pr), providing the best picture quality (some TV manufacturers label their component video sockets slightly differently).

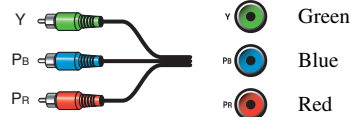

#### Composite video

Composite video is commonly used on TVs, VCRs, and other video equipment.



#### Optical digital audio

Optical digital connections allow you to enjoy digital sound such as PCM<sup>\*1</sup>, Dolby Digital or DTS. The audio quality is the same as coaxial.



#### Coaxial digital audio

Coaxial digital connections allow you to enjoy digital sound such as PCM<sup>\*1</sup>, Dolby Digital or DTS. The audio quality is the same as optical.



#### Analog audio (RCA)

Analog audio connections (RCA) carry analog audio.



\*1 Available sampling rate for PCM input signal (stereo/mono) is 32/44.1/48/88.2/96 kHz. In case of an HDMI connection, 176.4/192 kHz is also available.

#### Note

- The AV receiver does not support SCART plugs.
- The AV receiver's optical digital jacks have shutter-type covers that open when an optical plug is inserted and close when it's removed. Push plugs in all the way.

#### Caution

- To prevent shutter damage, hold the optical plug straight when inserting and removing.

## Connecting Components with HDMI

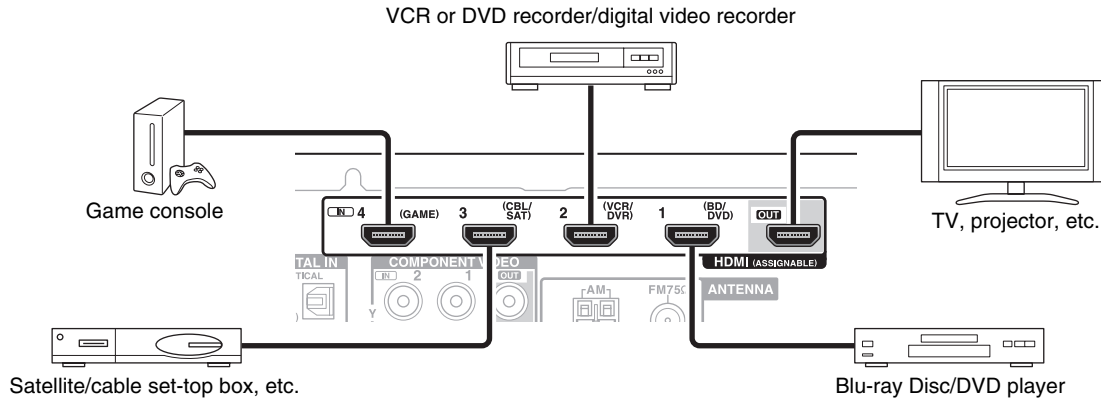

- \* If your TV doesn't support Audio Return Channel (ARC), you need to connect an optical digital cable together with the HDMI cable to the AV receiver.
- \* When listening to an HDMI component through the AV receiver, set the HDMI component so that its video can be seen on the TV screen (on the TV, select the input of the HDMI component connected to the AV receiver). If the TV power is off or the TV is set to another input source, this may result in no sound from the AV receiver or the sound may be cut off.

Connect your components to the appropriate jacks. The default input assignments are shown below.

✓: Assignment can be changed (→ [page 39](#)).

Jack	Components	
HDMI IN1	Blu-ray Disc/DVD player	✓
HDMI IN2	VCR or DVD recorder/digital video recorder	✓
HDMI IN3	Satellite/cable set-top box, etc.	✓
HDMI IN4	Game console	✓
HDMI OUT	TV, projector, etc.	

See also:

- “Connection Tips and Video Signal Path” (→ [page 59](#))
- “Using an RIHD-compatible TV, Player, or Recorder” (→ [page 60](#))
- “About HDMI” (→ [page 62](#))

### Tip

- To listen to the audio of a component connected via HDMI through your TV's speakers, enable “HDMI Through” (→ [page 45](#)) and set the AV receiver to standby mode.

### Note

- In the case of Blu-ray Disc/DVD players, if no sound is output despite following the above-mentioned procedure, set your Blu-ray Disc/DVD player's HDMI audio settings to PCM.

### ■ Audio Return Channel (ARC) function

Audio Return Channel (ARC) function enables an HDMI capable TV to send the audio stream to the **HDMI OUT** of the AV receiver.

- This function can be used when:
  - Your TV is ARC capable, and
  - The **TV/CD** input selector is selected, and
  - “HDMI Ctrl (RIHD)” is set to “On” (→ [page 45](#)), and
  - “Audio Return Ch (ARC)” is set to “Auto” (→ [page 46](#)).



## Connecting Your Components

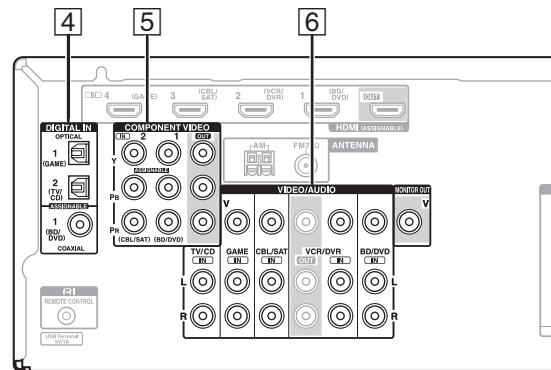
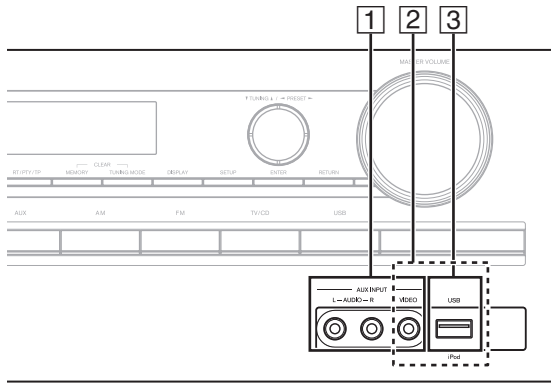

The on-screen menus appear only on a TV that is connected to the **HDMI OUT**. If your TV is connected to other video outputs, use the AV receiver's display when changing settings.

✓: Assignment can be changed (→ [pages 39, 40](#)).

No.	Jack/Port	Components		
1	AUX INPUT			
	VIDEO	Camcorder, etc.		
	AUDIO L/R			
2	USB, AUX INPUT VIDEO*1	iPod/iPhone (video playback)		
3	USB*2	iPod/iPhone, MP3 player, USB flash drive		
4	DIGITAL IN			
	OPTICAL 1 (GAME)	Game console	✓	
	OPTICAL 2 (TV/CD)	TV, CD player	✓	
	COAXIAL (BD/DVD)	Blu-ray Disc/DVD player	✓	
5	COMPONENT VIDEO			
	IN 1 (BD/DVD)	Blu-ray Disc/DVD player, RI dock	✓	
	IN 2 (CBL/SAT)	Satellite/cable set-top box, RI dock, etc.	✓	
	OUT	TV, projector, etc.		
	6	MONITOR OUT	TV, projector, etc.	
		BD/DVD IN	Blu-ray Disc/DVD player	
	VCR/DVR IN	VCR, DVD recorder/digital video recorder, RI dock		
	CBL/SAT IN	Satellite/cable set-top box, etc.		
	GAME IN	Game console, RI dock		
	TV/CD IN	TV, CD player, cassette tape deck, MD, CD-R, Turntable*3, RI dock		

### Note

- \*1 When **USB** input is selected, you can input video signals from the **AUX INPUT VIDEO** jack. Video signals input from **AUX INPUT VIDEO** will be output from the **MONITOR OUT** jack.
- \*2 Do not connect the AV receiver's **USB** port to a USB port on your computer. Music on your computer cannot be played through the AV receiver in this way.
- \*3 Connect a turntable (MM) that has a phono preamp built-in. If your turntable (MM) doesn't have it, you'll need a commercially available phono preamp. If your turntable has a moving coil (MC) type cartridge, you'll need a commercially available MC head amp or MC transformer as well as a phono preamp. See your turntable's manual for details.

- With connection [4](#), you can enjoy Dolby Digital and DTS.

- With connection [6](#), if your Blu-ray Disc/DVD player has both the main stereo and multichannel outputs, be sure to connect to the main stereo.

### ■ How to record a video source

With the connections described above, you cannot record the videos through the AV receiver. See "Recording" about connections for video recording (→ [page 36](#)).

Connect your components to the appropriate jacks. The default input assignments are shown below.

See "Connection Tips and Video Signal Path" for more information (→ [page 59](#)).

## Connecting Onkyo RI Components

- 1 Make sure that each Onkyo component is connected with an analog audio cable (connection 6 in the hookup examples) (→ page 17).
- 2 Make the RI connection (see the illustration).
- 3 If you're using an RI Dock or cassette tape deck, change the Input Display (→ page 35).

With **RI** (Remote Interactive), you can use the following special functions:

### ■ System On/Auto Power On

When you start playback on a component connected via **RI** while the AV receiver is on standby, the AV receiver will automatically turn on and select that component as the input source.

### ■ Direct Change

When playback is started on a component connected via **RI**, the AV receiver automatically selects that component as the input source.

### ■ Remote Control

You can use the AV receiver's remote controller to control your other **RI**-capable Onkyo components, pointing the remote controller at the AV receiver's remote control sensor instead of the component. You must enter the appropriate remote control code first (→ page 50).

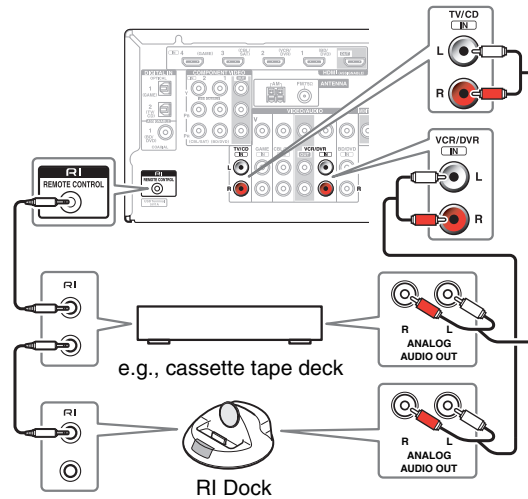

### Note

- Use only **RI** cables for **RI** connections. **RI** cables are supplied with Onkyo components.
- Some components have two **RI** jacks. You can connect either one to the AV receiver. The other jack is for connecting additional **RI**-capable components.
- Connect only Onkyo components to **RI** jacks. Connecting other manufacturer's components may cause a malfunction.
- Some components may not support all **RI** functions. Refer to the manuals supplied with your other Onkyo components.

## Connecting a Recording Component

See “Recording” for details on recording (→ page 36).

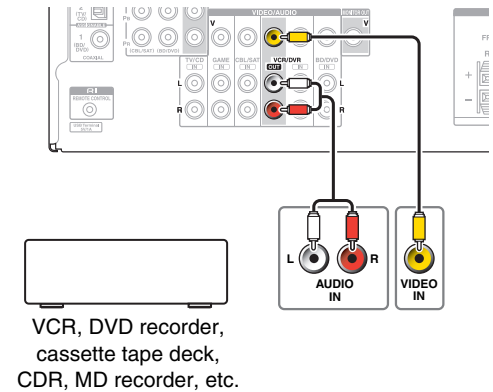

### Note

- The AV receiver must be turned on for recording. Recording is not possible while it's in standby mode.
- If you want to record directly from your TV or playback VCR to the recording VCR without going through the AV receiver, connect the TV/VCR's audio and video outputs directly to the recording VCR's audio and video inputs. See the manuals supplied with your TV and VCR for details.
- Video signals connected to composite video inputs can be recorded only via composite video outputs. For example, if your TV/VCR is connected to a composite video input, the recording VCR must be connected to a composite video output.
- The surround sound and DSP listening modes cannot be recorded.
- Copy-protected Blu-ray Discs and DVDs cannot be recorded.
- Sources connected to a digital input cannot be recorded. Only analog inputs can be recorded.
- DTS signals will be recorded as noise, so don't attempt analog recording of DTS CDs or LDs.

## Connecting the Antennas

This section explains how to connect the supplied indoor FM antenna and AM loop antenna. The AV receiver won't pick up any radio signals without any antenna connected, so you must connect the antenna to use the tuner.

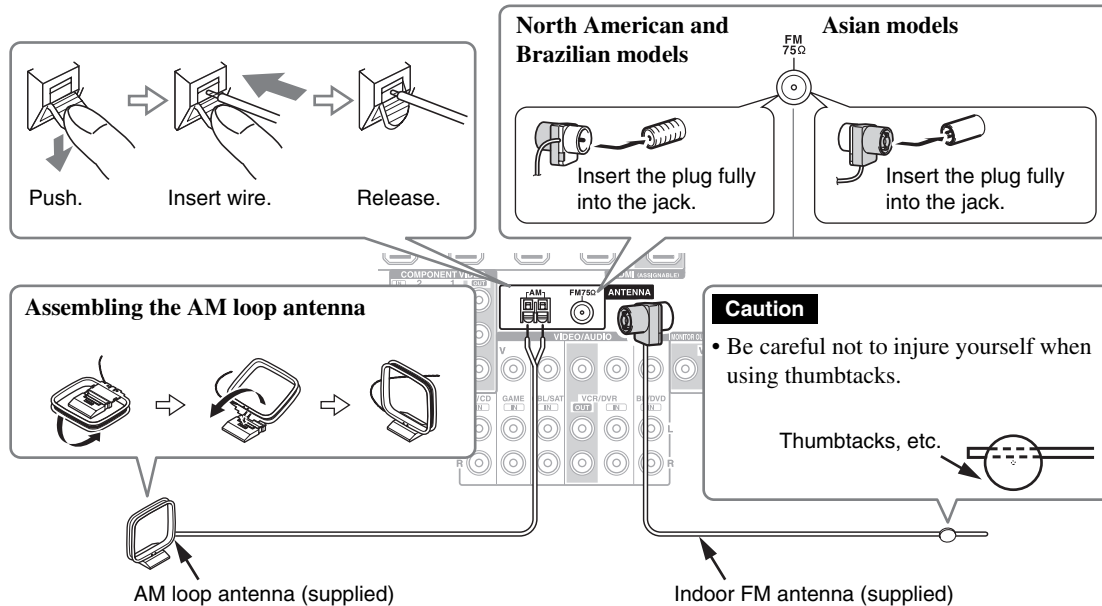

### Note

- Once your AV receiver is ready for use, you'll need to tune into a radio station and position the antenna to achieve the best possible reception.
- Keep the AM loop antenna as far away as possible from your AV receiver, TV, speaker cables, and power cords.

### Tip

- If you cannot achieve good reception with the supplied indoor FM antenna, try a commercially available outdoor FM antenna instead.
- If you cannot achieve good reception with the supplied indoor AM loop antenna, try using it with a commercially available outdoor AM antenna.

## Connecting the Power Cord

- (Brazilian models)**  
Connect the supplied power cord to the AV receiver's AC INLET.

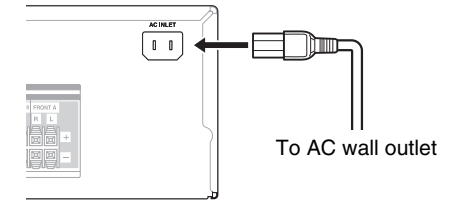

- Plug the power cord into an AC wall outlet.

### Note

- Before connecting the power cord, connect all of your speakers and AV components.
- Turning on the AV receiver may cause a momentary power surge that might interfere with other electrical equipment on the same circuit. If this is a problem, plug the AV receiver into a different branch circuit.
- Do not use a power cord other than the one supplied with the AV receiver. The supplied power cord is designed exclusively for use with the AV receiver and should not be used with any other equipment.
- Never disconnect the power cord from the AV receiver while the other end is still plugged into a wall outlet. Doing so may cause an electric shock. Always disconnect the power cord from the wall outlet first, and then the AV receiver.

# Turning On/Off the AV Receiver

⏻ ON/STANDBY

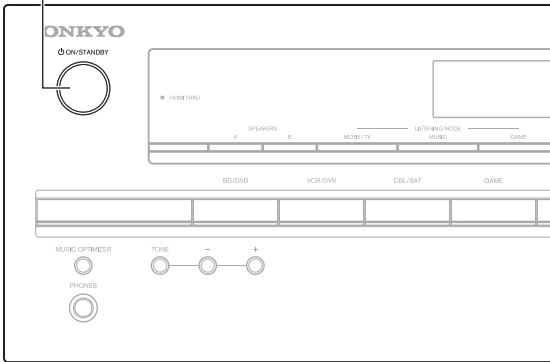

## Turning On

1 Press **⏻ ON/STANDBY** on the front panel.

or

Press **RECEIVER** followed by **⏻** on the remote controller.

The AV receiver comes on, and its display lights.

## Turning Off

1 Press **⏻ ON/STANDBY** on the front panel.

or

Press **RECEIVER** followed by **⏻** on the remote controller.

The AV receiver will enter standby mode. To prevent any loud surprises when you turn on the AV receiver, always turn down the volume before you turn it off.

### Tip

- For details on power management settings, see “Auto Standby” (→ [page 44](#)).



# Playback

The on-screen menus appear only on a TV that is connected to the **HDMI OUT**. If your TV is connected to other video outputs, use the AV receiver's display when changing settings.

This section describes the procedure for using the remote controller unless otherwise specified.

## Playing the Connected Component

### ■ Operating with the remote controller



- 1** Press **RECEIVER** followed by an **INPUT SELECTOR** button.
- 2** Start playback on the source component.  
See also:
  - “Playing an iPod/iPhone via USB” (→ [page 23](#))
  - “Playing a USB Device” (→ [page 24](#))
  - “Listening to AM/FM Radio” (→ [page 25](#))
  - “iPod/iPhone Playback via Onkyo Dock” (→ [page 48](#))
  - “Controlling Other Onkyo Components” (→ [page 50](#))
- 3** To adjust the volume, use **VOL ▲/▼**.
- 4** Select a listening mode and enjoy!  
See also:
  - “Using the Listening Modes” (→ [page 28](#))

### ■ Operating on the AV receiver

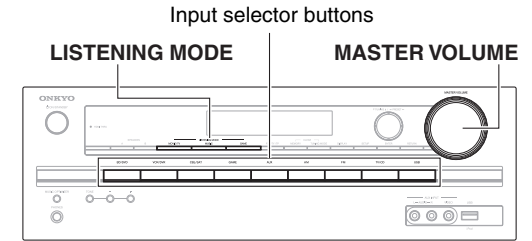

- 1** Use the input selector buttons to select the input source.
- 2** Start playback on the source component.
- 3** To adjust the volume, use the **MASTER VOLUME** control.
- 4** Select a listening mode and enjoy!

## Controlling Contents of USB Devices

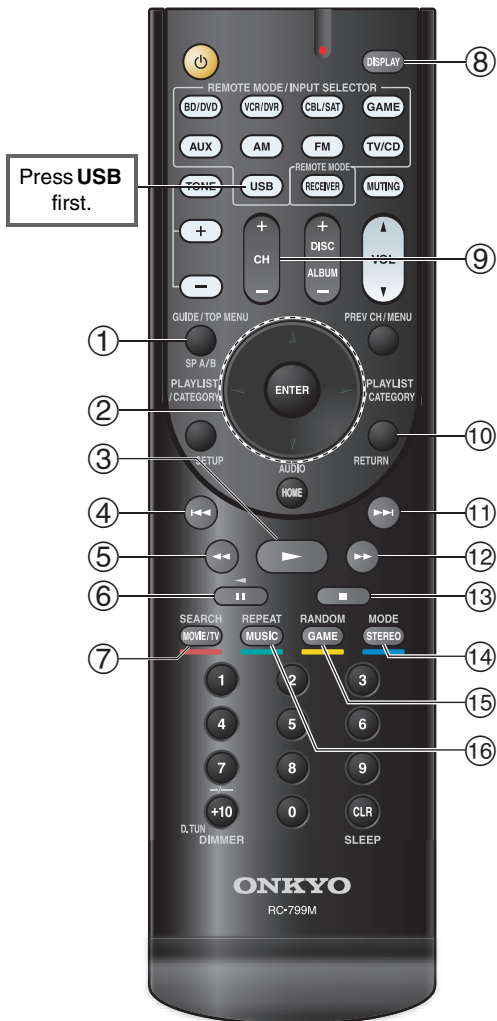

- ① **TOP MENU**  
This button displays the top menu for each media or service.
- ② **▲/▼ and ENTER**  
These buttons navigate through the menus.  
◀/▶  
This button cycles through pages.  
**PLAYLIST** ◀/▶  
In Standard Mode (iPod/iPhone), this button selects playlists.
- ③ ▶  
This button starts playback.
- ④ ◀◀  
This button selects the beginning of the current song. Pressing this button twice selects the previous song.
- ⑤ ◀◀  
This button fast-reverses the current song.
- ⑥ ||  
This button pauses playback.
- ⑦ **SEARCH**  
You can toggle between the playback screen and the list screen during playback.
- ⑧ **DISPLAY**  
This button switches between song information.
- ⑨ **CH +/-**  
In Standard Mode (iPod/iPhone), this button selects albums.
- ⑩ **RETURN**  
This button returns to the previous menu.
- ⑪ ▶▶  
This button selects the next song.
- ⑫ ▶▶  
This button fast-forwards the current song.
- ⑬ ■  
This button stops playback.
- ⑭ **MODE**  
You can switch between Extended Mode and Standard Mode during iPod/iPhone playback.

- ⑮ **RANDOM**  
This button performs random playback.
- ⑯ **REPEAT**  
Press this button repeatedly to cycle through the repeat modes.

### Tip













- See “Controlling Other Onkyo Components” about the operation of other components (→ [page 50](#)).

### Note

- The buttons you can use will differ depending on the devices and media used for playback.

## Understanding Icons on the Display

This section describes icons that appear on the AV receiver's display during media playback.

Icon	Description
	Folder
	Track
	Playback
	Pause
	Fast Forward
	Fast Reverse
	Artist
	Album
	Repeat One Track
	Repeat Folder (USB Device)
	Repeat
	Shuffle
	Shuffle Album (iPod/iPhone)

## Playing an iPod/iPhone via USB

The on-screen menus appear only on a TV that is connected to the HDMI OUT.

This section explains how to play music files on the iPod/iPhone.

Compatible iPod/iPhone models

Made for:

iPod touch (1st, 2nd, 3rd and 4th generation), iPod classic, iPod nano (2nd, 3rd, 4th, 5th and 6th generation), iPhone 4S, iPhone 4, iPhone 3GS, iPhone 3G, iPhone

- 1 Press **USB** to select the “USB” input.
- 2 Connect the USB cable that comes with the iPod/iPhone to the USB port on the front of the AV receiver.  
While reading the contents of your iPod/iPhone, the message “**Connecting...**” appears on the AV receiver's display.  
A list of your iPod/iPhone model's contents appears (Extended Mode).
- 3 Use **▲/▼** to select a folder, and then press **ENTER** to open it.

### Tip

- If you want to operate using the iPod/iPhone or the remote controller, press **MODE** to switch to Standard mode.
- When you disconnect the iPod/iPhone, the AV receiver remembers the current mode. This means that if you disconnect when in Extended Mode, the AV receiver will start in Extended Mode the next time you connect the iPod/iPhone.
- You can also use the **▲/▼**, **ENTER** and **TUNING MODE** buttons on the front panel. **TUNING MODE** allows you to switch modes.
- When connecting your iPod/iPhone with a USB cable, we recommend you use an official USB cable from Apple Inc.

- 4 Use **▲/▼** to select a music file, and press **ENTER** or **▶** to start playback.

### Note

- While the message “**Connecting...**” appears on the AV receiver's display, do not disconnect the USB cable supplied with your iPod/iPhone or the USB device from the **USB** port.
- If you connect an iPod or iPhone to the **USB** port, no sound will be output from the headphones jack.

## Extended Mode Control

The content information is displayed (lists are displayed), and you can control the content while looking at the screen.

Top screen list:

Playlists, Artists, Albums, Genres, Songs, Composers, Shuffle Songs, Now Playing.

## Standard Mode Control

The content information is not displayed, but can be operated using the iPod/iPhone or the remote controller.



## Playing a USB Device

The on-screen menus appear only on a TV that is connected to the **HDMI OUT**.

This section explains how to play music files from a USB device (e.g., USB flash drives and MP3 players).

See also:

- “USB Features” (→ [page 63](#)).

- 1 Press **USB** to select the “USB” input.**
- 2 Plug your USB device into the AV receiver’s USB port.**  
While reading the contents of your USB device, the message “**Connecting...**” appears on the AV receiver’s display.
- 3 Press **ENTER**.**  
A list of the device’s contents appears. To open a folder, use **▲/▼** to select it, and then press **ENTER**.
- 4 Use **▲/▼** to select a music file, and press **ENTER** or **▶** to start playback.**

### Note

- While the message “**Connecting...**” appears on the AV receiver’s display, do not disconnect the USB cable supplied with your iPod/iPhone or the USB device from the **USB** port.



## Listening to AM/FM Radio

This section describes the procedure using the buttons on the front panel unless otherwise specified.

### Using the Tuner

With the built-in tuner you can enjoy AM and FM radio stations. You can store your favorite stations as presets for quick selection.

You can also change the frequency steps (→ [page 44](#)).

- 1 Press **AM** or **FM** to select either “AM” or “FM”.  
In this example, FM has been selected.

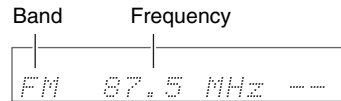

(Actual display depends on the country.)

## Tuning into Radio Stations

### Auto tuning mode

- 1 Press **TUNING MODE** so that the **AUTO** indicator lights on the AV receiver’s display.
- 2 Press **TUNING ▲/▼**.  
Searching stops when a station is found.  
When tuned into a station, the **TUNED** indicator lights. When tuned into a stereo FM station, the **FM STEREO** indicator lights as shown.

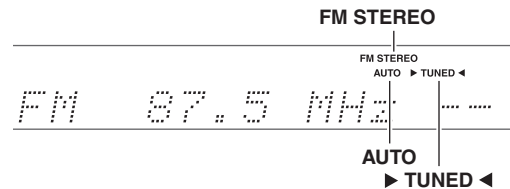

#### Tip

##### • Tuning into weak FM stereo stations

If the signal from a stereo FM station is weak, it may be impossible to get good reception. In this case, switch to manual tuning mode and listen to the station in mono.

### Manual tuning mode

In manual tuning mode, FM stations will be in mono.

- 1 Press **TUNING MODE** so that the **AUTO** indicator goes off on the AV receiver’s display.
- 2 Press and hold **TUNING ▲/▼**.  
The frequency stops changing when you release the button.  
Press the buttons repeatedly to change the frequency one step at a time.

### Tuning into stations by frequency

You can tune into AM and FM stations directly by entering the appropriate frequency.

- 1 On the remote controller, press **AM** or **FM** to select “AM” or “FM”, followed by **D.TUN**.



(Actual display depends on the country.)

- 2 Within 8 seconds, use the number buttons to enter the frequency of the radio station.

For example, to tune to 87.5 (FM), press **8, 7, 5**.

If you have entered the wrong number, you can retry after 8 seconds.

## Presetting AM/FM Stations

You can store a combination of up to 40 of your favorite AM/FM radio stations as presets.

### 1 Tune into the AM/FM station that you want to store as a preset.

See the previous section.

### 2 Press MEMORY.

The preset number flashes.

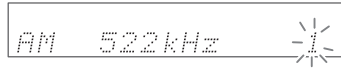

(Actual display depends on the country.)

### 3 While the preset number is flashing (about 8 seconds), use PRESET ◀/▶ to select a preset from 1 through 40.

### 4 Press MEMORY again to store the station or channel.

The station or channel is stored and the preset number stops flashing.

Repeat this procedure for all of your favorite AM/FM radio stations.

## ■ Selecting Presets

### 1 To select a preset, use PRESET ◀/▶ on the AV receiver, or the remote controller's CH +/-.

#### Tip

- You can also use the remote controller's number buttons to select a preset directly.

## ■ Deleting Presets

### 1 Select the preset that you want to delete.

See the previous section.

### 2 While holding down MEMORY, press TUNING MODE.

The preset is deleted and its number disappears from the AV receiver's display.

## Using RDS (excluding North American and Brazilian models)

**RDS works only in areas where RDS broadcasts are available.**

When tuned into an RDS station, the **RDS** indicator lights. When the station is broadcasting text information, the text can be displayed.

### ■ What is RDS?

RDS stands for Radio Data System and is a method of transmitting data in FM radio signals. It was developed by the European Broadcasting Union (EBU) and is available in most European countries. Many FM stations use it these days. In addition to displaying text information, RDS can also help you find radio stations by type (e.g., news, sport, rock, etc.).

The AV receiver supports four types of RDS information:  
**PS (Program Service)**

When tuned to an RDS station that's broadcasting PS information, the station's name will be displayed. Pressing **DISPLAY** will display the frequency for 3 seconds.

#### **RT (Radio Text)**

When tuned to an RDS station that's broadcasting text information, the text will be shown on the AV receiver's display as described in the next section.

#### **PTY (Program Type)**

This allows you to search for RDS radio stations by type (→ [page 27](#)).

#### **TP (Traffic Program)**

This allows you to search for RDS radio stations that broadcast traffic information (→ [page 27](#)).

↳ To be continued



**Note**

- In some cases, the text characters displayed on the AV receiver may not be identical to those broadcast by the radio station. Also, unexpected characters may be displayed when unsupported characters are received. This is not a malfunction.
- If the signal from an RDS station is weak, RDS data may be displayed intermittently or not at all.

**■ Displaying Radio Text (RT)****1 Press RT/PTY/TP once.**

The RT information scrolls across the AV receiver's display.

**Note**

- The message “**Waiting**” may appear while the AV receiver waits for the RT information.
- If the message “**No Text Data**” appears, no RT information is available.

**■ Finding Stations by Type (PTY)**

You can search for radio stations by type.

**1 Press RT/PTY/TP twice.**

The current program type appears on the AV receiver's display.

**2 Use PRESET ◀/▶ to select the type of program you want.**

See the table shown later in this chapter.

**3 To start the search, press ENTER.**

The AV receiver searches until it finds a station of the type you specified, at which point it stops briefly before continuing with the search.

**4 When a station you want to listen to is found, press ENTER.**

If no stations are found, the message “**Not Found**” appears.

**■ Listening to Traffic News (TP)**

You can search for stations that broadcast traffic news.

**1 Press RT/PTY/TP three times.**

If the current radio station is broadcasting TP (Traffic Program), “[TP]” will appear on the AV receiver's display. If “TP” without square brackets appears, this means that the station is not broadcasting TP.

**2 To locate a station that is broadcasting TP, press ENTER.**

The AV receiver searches until it finds a station that's broadcasting TP.

If no stations are found, the message “**Not Found**” appears.

**RDS program types (PTY)**

Type	Display
None	None
News reports	News
Current affairs	Affairs
Information	Info
Sport	Sport
Education	Educate
Drama	Drama
Culture	Culture
Science and technology	Science
Varied	Varied
Pop music	Pop M
Rock music	Rock M
Middle of the road music	Easy M
Light classics	Light M
Serious classics	Classics
Other music	Other M
Weather	Weather
Finance	Finance
Children's programmes	Children
Social affairs	Social
Religion	Religion
Phone in	Phone In
Travel	Travel
Leisure	Leisure
Jazz music	Jazz
Country music	Country
National music	Nation M
Oldies music	Oldies
Folk music	Folk M
Documentary	Document
Alarm test	TEST
Alarm	Alarm!



# Using Basic Functions

## Using the Listening Modes

### Selecting Listening Modes

See “About Listening Modes” for detailed information about the listening modes (→ [page 29](#)).

#### ■ Listening Mode Buttons

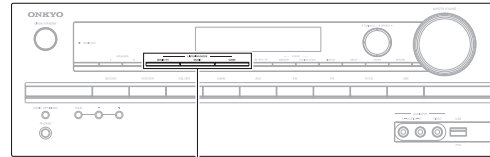

**MOVIE/TV, MUSIC, GAME**

#### **MOVIE/TV** button

This button selects the listening modes intended for use with movies and TV.

#### **MUSIC** button

This button selects the listening modes intended for use with music.

#### **GAME** button

This button selects the listening modes intended for use with video games.

#### **STEREO** button

This button selects the Stereo listening mode and All Channel Stereo listening mode.

- The Dolby Digital and DTS listening modes can only be selected if your Blu-ray Disc/DVD player is connected to the AV receiver with a digital audio connection (coaxial, optical, or HDMI).
- The listening modes you can select depends on the format of the input signal. To check the format, see “Displaying Source Information” (→ [page 34](#)).
- While a pair of headphones is connected, you can select the following listening modes: Direct, Stereo, and Mono.
- While Speakers A and B are on, you can select only the Direct, Stereo, Mono, or T-D (Theater-Dimensional) listening mode.

## About Listening Modes

The AV receiver's listening modes can transform your listening room into a movie theater or concert hall, with high fidelity and stunning surround sound.

### ■ Explanatory Notes

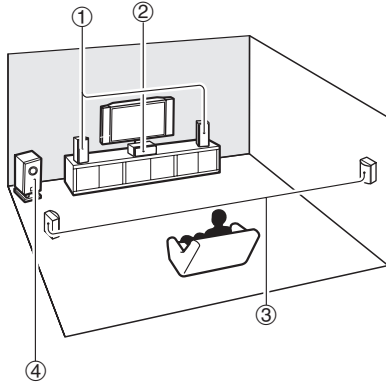

- ① Front speakers
- ② Center speaker
- ③ Surround speakers
- ④ Subwoofer

### Input Source

The following audio formats are supported by the listening mode.

<b>MONO</b>	This is mono (monophonic) sound.
<b>STEREO</b>	This is stereo (stereophonic) sound. Two independent audio signal channels are reproduced through two speakers.
<b>5.1ch</b>	This is 5.1-channel surround sound. This surround system has five main channels of sound and a sixth subwoofer channel (called the point-one channel).
<b>7.1ch</b> *1	This is 7.1-channel surround sound. This is a further sound enhancement to 5.1-channel sound with two additional speakers that provide greater sound envelopment and more accurate positioning of sounds.

\*1 The AV receiver outputs this source in 5.1-channel surround sound.

### Speaker Layout

The illustration shows which speakers are activated in each channel. See "Sp Config (Speaker Configuration)" for the speaker setup (→ [page 40](#)).

**2.1**

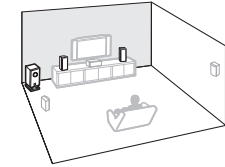

**3.1**

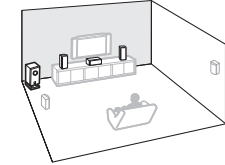

**5.1**

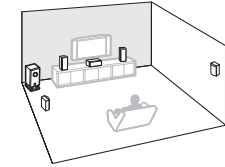

## ■ Onkyo-Original DSP Listening Modes

Listening Mode	Description	Input Source	Speaker Layout
<b>Orchestra<sup>*1</sup></b> <i>Orchestra</i>	Suitable for classical or operatic music, this mode emphasizes the surround channels in order to widen the stereo image, and simulates the natural reverberation of a large hall.	<b>MONO</b> <b>STEREO</b> <b>5.1ch</b> <b>7.1ch</b>	<b>5.1</b>
<b>Unplugged<sup>*1</sup></b> <i>Unplugged</i>	Suitable for acoustic instruments, vocals, and jazz, this mode emphasizes the front stereo image, giving the impression of being right in front of the stage.		
<b>Studio-Mix<sup>*1</sup></b> <i>Studio Mix</i>	Suitable for rock or pop music, listening to music in this mode creates a lively sound field with a powerful acoustic image, like being at a club or rock concert.		
<b>TV Logic<sup>*1</sup></b> <i>TV Logic</i>	This mode adds realistic acoustics to TV shows produced in a TV studio, surround effects to the entire sound, and clarity to voices.		
<b>Game-RPG<sup>*1</sup></b> <i>Game RPG</i>	In this mode, the sound has a dramatic feel with a similar atmosphere to Orchestra mode.		
<b>Game-Action<sup>*1</sup></b> <i>Game Action</i>	In this mode, sound localization is distinct with emphasis on bass.		
<b>Game-Rock<sup>*1</sup></b> <i>Game Rock</i>	In this mode, sound pressure is emphasized to heighten live feel.		
<b>Game-Sports<sup>*1</sup></b> <i>Game Sports</i>	In this mode, reverberation is increased and sound localization decreased slightly.		
<b>All Ch Stereo</b> <i>All Ch Stereo</i>	Ideal for background music, this mode fills the entire listening area with stereo sound from the front and surround speakers.		<b>3.1</b> <b>5.1</b>
<b>Full Mono</b> <i>Full Mono</i>	In this mode, all speakers output the same sound in mono, so the sound you hear is the same regardless of where you are within the listening room.		

Listening Mode	Description	Input Source	Speaker Layout
<b>T-D (Theater-Dimensional)<sup>*1</sup></b> <i>T D</i>	With this mode you can enjoy a virtual surround sound even with only two or three speakers. This works by controlling how sounds reach the listener's left and right ears. Good results may not be possible if there's too much reverb, so we recommend that you use this mode in an environment with little or no natural reverb.	<b>MONO</b> <b>STEREO</b> <b>5.1ch</b> <b>7.1ch</b>	<b>2.1</b> <b>3.1</b> <b>5.1</b>

## ■ Listening Modes

Listening Mode	Description	Input Source	Speaker Layout
<b>Direct</b> <i>Direct</i>	In this mode, audio from the input source is output without surround-sound processing. The speaker configuration (presence of speakers) and speaker distance settings are enabled, but much of the processing set via Home menu is disabled. A/V Sync does not have effect on the analog audio. See “On-screen Setup” for more details ( <a href="#">→ page 37</a> ).	<b>MONO</b> <b>STEREO</b> <b>5.1ch</b> <b>7.1ch</b>	<b>2.1</b> <b>3.1</b> <b>5.1</b>
<b>Stereo</b> <i>Stereo</i>	Sound is output from the front left and right speakers and subwoofer.		
<b>Mono</b> <i>Mono</i>	Use this mode when watching an old movie with a mono soundtrack, or use it with the foreign language soundtracks recorded in the left and right channels of some movies. It can also be used with DVDs or other sources containing multiplexed audio, such as karaoke DVDs.		
<b>Multichannel</b> <i>Multich</i>	This mode is for use with PCM multichannel sources.	<b>5.1ch</b> <b>7.1ch</b>	<b>3.1</b> <b>5.1</b>

Listening Mode	Description	Input Source	Speaker Layout	
<b>DSD<sup>2</sup></b> <i>DSD</i>	In this mode, audio from the input source is output without surround-sound processing. The speaker configuration (presence of speakers), crossover frequency, speaker distance, A/V Sync and much of the processing set via Home menu are enabled. See “On-screen Setup” for more details ( <a href="#">→ page 37</a> ).	<b>5.1ch</b>	<b>3.1</b> <b>5.1</b>	
<b>Dolby Digital</b> <i>Dolby D</i>				
<b>Dolby Digital Plus<sup>3</sup></b> <i>Dolby D +</i>		<b>5.1ch</b> <b>7.1ch</b>	<b>3.1</b> <b>5.1</b>	
<b>Dolby TrueHD</b> <i>Dolby TrueHD</i>				
<b>DTS</b> <i>DTS</i>		<b>5.1ch</b> <b>7.1ch</b>	<b>3.1</b> <b>5.1</b>	
<b>DTS-HD High Resolution Audio</b> <i>DTS HD HR</i>				
<b>DTS-HD Master Audio</b> <i>DTS HD MSTR</i>		<b>5.1ch</b>	<b>3.1</b> <b>5.1</b>	
<b>DTS Express</b> <i>DTS Express</i>				
<b>DTS 96/24</b> <i>DTS 96/24</i>		This mode is for use with DTS 96/24 sources. This is high-resolution DTS with a 96 kHz sampling rate and 24-bit resolution, providing superior fidelity. Use it with DVDs that bear the DTS 96/24 logo.	<b>5.1ch</b>	<b>3.1</b> <b>5.1</b>

Listening Mode	Description	Input Source	Speaker Layout
<b>Dolby Pro Logic II</b>	<b>Dolby Pro Logic II</b> expands any 2-channel source for 5.1-channel playback. It provides a very natural and seamless surround-sound experience that fully envelops the listener. As well as music and movies, video games can also benefit from the dramatic spatial effects and vivid imaging.		
<i>PLII Movie</i>	<ul style="list-style-type: none"> <li>• <b>Dolby PLII Movie</b> Use this mode with DVDs and videos that bear the Dolby Surround logo or TV shows that feature Dolby Surround. You can also use this mode with stereo movies or TV shows and the AV receiver will create a 5.1 surround mix from the 2-channel stereo.</li> <li>• <b>Dolby PLII Music</b> Use this mode to add 5.1 surround to stereo sources such as music CDs and DVDs.</li> <li>• <b>Dolby PLII Game</b> Use this mode when playing game discs.</li> </ul>	<b>STEREO</b>	<b>3.1   5.1</b>
<i>PLII Music</i>			
<i>PLII Game</i>			
<b>Neo:6</b>	This mode expands any 2-channel source for up to 5.1-channel playback. It uses seven full-bandwidth channels of matrix decoding for matrix-encoded material, providing a very natural and seamless surround sound experience that fully envelops the listener.		
<i>Neo:6 Cinema</i>	<ul style="list-style-type: none"> <li>• <b>Neo:6 Cinema</b> Use this mode with any stereo movie (e.g., TV, DVD, VHS).</li> <li>• <b>Neo:6 Music</b> Use this mode with any stereo music source (e.g., CD, radio, cassette, TV, VHS, DVD).</li> </ul>	<b>STEREO</b>	<b>3.1   5.1</b>
<i>Neo:6 Music</i>			

**Note**

- \*1 These listening modes cannot be selected during USB or iPod playback.
- \*2 The AV receiver can input the DSD signal from HDMI IN. Setting the output setting on the player side to PCM might obtain a better sound according to the player. In that case, set the output setting on the player side to PCM.
- \*3 For the Blu-ray Discs, Dolby Digital is used.
- The listening modes cannot be selected with some source formats.



## Using the Home Menu

The Home menu provides quick access to frequently used settings. You can change settings and view the current information.

The on-screen menus appear only on a TV that is connected to the HDMI OUT. If your TV is connected to other video outputs, use the AV receiver's display when changing settings.

### Note

- The on-screen menus are displayed when:
  - There is no video input, or
  - The video input is 480p, 576p, 720p, 1080i, or 1080p.

### 1 Press RECEIVER followed by HOME.

The Home menu will be superimposed on the TV screen.

### 2 Use ▲/▼ and ENTER to make the desired selection.

#### ■ Input

- ▶ You can select the input source.

Use ▲/▼ to select the desired input source.

Pressing **ENTER** switches to the selected input source.

#### ■ Audio

- ▶ You can change the following settings: “Bass”, “Treble”, “Subwoofer Level”, “Center Level”, “EX.BASS”, “Late Night”, “Music Optimizer”, and “Cinema Filter”.

See also:

- “Using the Audio Settings” (→ [page 46](#))

#### ■ Info<sup>\*1</sup>

- ▶ You can view the information of the following items: “Input” and “Output”.

#### ■ Listening Mode<sup>\*2</sup>

- ▶ You can select the listening modes that are grouped in the following categories: “MOVIE/TV”, “MUSIC” and “GAME”.  
Use ▲/▼ to select the category and ◀/▶ to select the listening mode. Press **ENTER** to switch to the selected listening mode.

### Note

- <sup>\*1</sup> Depending on the input source and listening mode, not all channels shown here output the sound.
- <sup>\*2</sup> • This setting is not available in either of the following cases:  
–The “Audio TV Out” setting is set to “On” (→ [page 45](#)).  
–“HDMI Ctrl (RIHD)” is set to “On” (→ [page 45](#)) and you're listening through your TV speakers.

## Selecting Speakers A and B

You can use two sets of front speakers with the AV receiver: *Speakers A* for up to 5.1-channel playback in your main listening room and *Speakers B* for 2-channel stereo playback in another room.

### 1 Press RECEIVER once followed by SP A/B repeatedly to cycle through the selection:

Speakers A → Speakers A&B → Speakers B  

Speaker indicators and output channels are shown below.

Speaker indicators	Output channel
<b>A</b>	Speakers A: 5.1 channels
<b>A B</b>	Speakers A: 2.1 channels <sup>*3</sup> Speakers B: 2 channels
<b>B</b>	Speakers B: 2 channels
	No sound

<sup>\*3</sup> While Speakers B is on, channels are reduced to 2.1 in the main room.

### Tip

- Alternatively, you can use the AV receiver's **SPEAKERS A** and **B**.



## Using the Sleep Timer

With the sleep timer, you can set the AV receiver to turn off automatically after a specified period.

### 1 Press **RECEIVER** once followed by **SLEEP** repeatedly to select the required sleep time.

The sleep time can be set from 90 to 10 minutes in 10 minute steps.

The **SLEEP** indicator lights on the AV receiver's display when the sleep timer has been set. The specified sleep time appears for about 5 seconds, then the previous display reappears.

#### Tip

- If you need to cancel the sleep timer, press **SLEEP** repeatedly until the **SLEEP** indicator goes off.
- To check the time remaining until the AV receiver sleeps, press **SLEEP**. Note that if you press again on **SLEEP** as the time being displayed is equal to 10 minutes or less, the sleep timer will go off.

## Setting the Display Brightness

You can adjust the brightness of the AV receiver's display.

### 1 Press **RECEIVER** once followed by **DIMMER** repeatedly to switch between: normal, dim, or dimmer brightness.

#### Tip

- (North American and Brazilian models) Alternatively, you can use the AV receiver's **DIMMER**.

## Displaying Source Information

You can display various information about the current input source as follows.

### 1 Press **RECEIVER** once followed by **DISPLAY** repeatedly to cycle through the available information.

#### Tip

- Alternatively, you can use the AV receiver's **DISPLAY**.

The following information can typically be displayed.

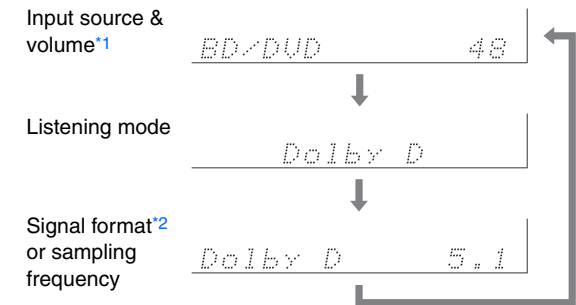

\*1 When AM or FM radio is used, the band, frequency, and preset number are displayed.

\*2 If the input signal is digital, the signal format is displayed. Information is displayed for about three seconds, then the previously displayed information reappears.

## Changing the Input Display

When you connect an **RI**-capable Onkyo component, you must configure the input display so that **RI** can work properly.

This setting can be done only from the front panel.

### 1 Press **TV/CD**, **GAME** or **VCR/DVR**.

“**TV/CD**”, “**GAME**” or “**VCR/DVR**” appears on the AV receiver’s display.

### 2 Press and hold down the same button (about 3 seconds) to change the input display.

Repeat this step to select the desired input display.

■ **TV/CD:** TV/CD → DOCK  
                   ↑ TAPE ←

■ **GAME:** GAME ↔ DOCK

■ **VCR/DVR:** VCR/DVR ↔ DOCK

#### Note

- “**DOCK**” can be selected for the “**TV/CD**”, “**GAME**” or “**VCR/DVR**” input selector, but not at the same time.
- Enter the appropriate remote control code before using the remote controller for the first time (→ [page 50](#)).

## Using the Music Optimizer

The Music Optimizer function enhances the sound quality of compressed music files.

### 1 Press **MUSIC OPTIMIZER** on the front panel.

The **M.Opt** indicator lights on the AV receiver’s display.

#### Tip

- Alternatively, you can use the remote controller’s **HOME**.
- See “Music Optimizer” for more details (→ [page 47](#)).

## Muting the AV Receiver

You can temporarily mute the output of the AV receiver.

### 1 Press **RECEIVER** followed by **MUTING**.

The output is muted and the **MUTING** indicator flashes on the AV receiver’s display.

#### Tip

- To unmute, press **MUTING** again or adjust the volume.
- Muting is automatically cancelled when the AV receiver is set to standby.

## Using Headphones

- 1 **Connect a pair of stereo headphones with a standard plug (1/4 inch or 6.3 mm) to the PHONES jack.**

### Note

- Always turn down the volume before connecting your headphones.
- While the headphones plug is inserted in the **PHONES** jack, the speakers are turned off.
- When you connect a pair of headphones, the listening mode is set to Stereo, unless it's already set to Stereo, Mono, or Direct.
- If you connect an iPod or iPhone to the **USB** port on the AV receiver, no sound will be output from the headphones jack.

## Recording

This section explains how to record the selected input source to a component with recording capability.

### AV Recording

Audio sources can be recorded to a recorder (e.g., cassette tape deck, CDR, MD recorder). Video sources can be recorded to a video recorder (e.g., VCR, DVD recorder).

- 1 **Use the input selector buttons to select the source that you want to record.**

You can watch the source while recording. The AV receiver's **MASTER VOLUME** control has no effect on recording.

- 2 **On your recorder, start recording.**

- 3 **On the source component, start playback.**

If you select another input source during recording, that input source will be recorded.

# On-screen Setup

The setup menus provides a convenient way to change the AV receiver's various settings. Settings are organized into 10 categories.

The on-screen menus appear only on a TV that is connected to the HDMI OUT. If your TV is connected to other video outputs, use the AV receiver's display when changing settings.

This section describes the procedure for using the remote controller unless otherwise specified.

## Note

- The on-screen menus are displayed when:
  - There is no video input, or
  - The video input is 480p, 576p, 720p, 1080i, or 1080p.

## Common Procedures in Setup Menu



- 1 Press **RECEIVER** followed by **SETUP**.
- 2 Use **▲/▼** to select a menu item, and then press **ENTER**.
- 3 Use **▲/▼** to select a setting target, and use **◀/▶** to change the setting.  
Press **SETUP** to close the menu.  
Press **RETURN** to return to the previous menu.

## Note

- This procedure can also be performed on the AV receiver by using **SETUP**, the cursor buttons, and **ENTER**.

## Explanatory Notes



- ① Menu selection
- ② Setting target
- ③ Setting options (default setting underlined)

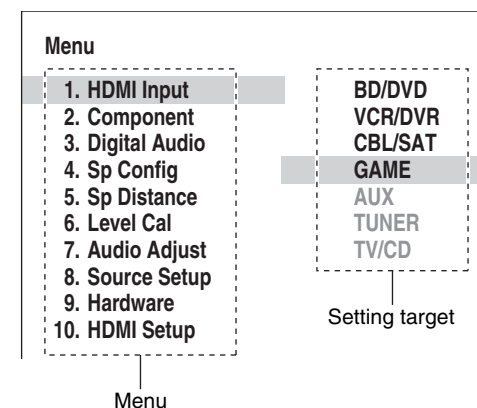

## Setup menu items

Menu item	Setting target
<b>HDMI Input</b> (→ <a href="#">page 39</a> )	BD/DVD
	VCR/DVR
	CBL/SAT
	GAME
	AUX
	TV/CD
<b>Component</b> (→ <a href="#">page 39</a> )	BD/DVD
	VCR/DVR
	CBL/SAT
	GAME
	AUX
	TV/CD
<b>Digital Audio</b> (→ <a href="#">page 40</a> )	BD/DVD
	VCR/DVR
	CBL/SAT
	GAME
	AUX
	TV/CD
<b>Sp Config</b> (→ <a href="#">page 40</a> )	Subwoofer
	Front
	Center
	Surround
	Crossover
	Double Bass
<b>Sp Distance</b> (→ <a href="#">page 41</a> )	Unit
	Left
	Center
	Right
	Surround Right
	Surround Left
	Subwoofer

Menu item	Setting target
<b>Level Cal</b> (→ <a href="#">page 41</a> )	Left
	Center
	Right
	Surround Right
	Surround Left
	Subwoofer
<b>Audio Adjust</b> (→ <a href="#">page 42</a> )	Input Ch (Mux)
	Input Ch (Mono)
	Panorama
	Dimension
	Center Width
	Center Image
	Listening Angle
<b>Source Setup</b> (→ <a href="#">page 43</a> )	A/V Sync
	Name
	Audio Selector
	Fixed Mode
<b>Hardware</b> (→ <a href="#">page 44</a> )	Volume OSD
	Remote ID
	AM/FM Freq Step
	AM Freq Step
	Auto Standby
<b>HDMI Setup</b> (→ <a href="#">page 45</a> )	HDMI Ctrl (RIHD)
	HDMI Through
	Audio TV Out
	Audio Return Ch
	LipSync

## HDMI Input



### Menu HDMI Input

If you connect a video component to an HDMI input, you must assign that input to an input selector. For example, if you connect your Blu-ray Disc/DVD player to **HDMI IN 2**, you must assign “**HDMI2**” to the “**BD/DVD**” input selector.

Here are the default assignments.

Input selector	Default assignment
BD/DVD	HDMI1
VCR/DVR	HDMI2
CBL/SAT	HDMI3
GAME	HDMI4
AUX	-----
TV/CD	-----

#### ■ BD/DVD, VCR/DVR, CBL/SAT, GAME, AUX, TV/CD

##### ▶ HDMI1, HDMI2, HDMI3, HDMI4:

Select the input to which the component has been connected.

##### ▶ -----:

Select if you're not using the **HDMI OUT**.

Each HDMI input cannot be assigned to two input selectors or more. When **HDMI1 - HDMI4** have already been assigned, you must first set any unused input selectors to “-----” or you will be unable to assign **HDMI1 - HDMI4** to input selector.

#### Note

- If no video component is connected to HDMI output (even if the HDMI input is assigned), the AV receiver selects the video source based on the setting of “Component (Component Video Input)”.
- When an **HDMI IN** is assigned to an input selector as explained here, the same **HDMI IN** will be set as a priority in the “Digital Audio (Digital Audio Input)” (→ [page 40](#)). In this case, if you want to use the coaxial or optical audio input, make the appropriate selection in the “**Audio Selector**” setting (→ [page 43](#)).
- Do not assign an **HDMI IN** to the **TV/CD** selector while “**HDMI Ctrl (RIHD)**” is set to “**On**” (→ [page 45](#)), otherwise appropriate CEC (Consumer Electronics Control) operation will not be guaranteed.
- If you assign “-----” to an input selector that is currently selected in “**HDMI Through**” (→ [page 45](#)), the “**HDMI Through**” setting will be automatically switched to “**Off**”.
- The “**TUNER**” selector cannot be assigned and is fixed at the “-----” option.

## Component (Component Video Input)



### Menu Component

If you connect a video component to a component video input, you must assign that input to an input selector. For example, if you connect your Blu-ray Disc/DVD player to **COMPONENT VIDEO IN 2**, you must assign “**IN2**” to the “**BD/DVD**” input selector.

Here are the default assignments.

Input selector	Default assignment
BD/DVD	IN1
VCR/DVR	-----
CBL/SAT	IN2
GAME	-----
AUX	-----
TV/CD	-----

#### ■ BD/DVD, VCR/DVR, CBL/SAT, GAME, AUX, TV/CD

##### ▶ IN1, IN2:

Select the input to which the component has been connected.

##### ▶ -----:

Select if you're not using the **COMPONENT VIDEO OUT**.

#### Note

- The “**TUNER**” selector cannot be assigned and is fixed at the “-----” option.



## Digital Audio (Digital Audio Input)



### Menu Digital Audio

If you connect a component to a digital audio input, you must assign that input to an input selector. For example, if you connect your CD player to the **OPTICAL IN 1**, you must assign “**OPTICAL1**” to the “**TV/CD**” input selector. Here are the default assignments.

Input selector	Default assignment
BD/DVD	COAXIAL
VCR/DVR	-----
CBL/SAT	-----
GAME	OPTICAL1
AUX	-----
TV/CD	OPTICAL2

### ■ BD/DVD, VCR/DVR, CBL/SAT, GAME, AUX, TV/CD

#### ▶ COAXIAL, OPTICAL1, OPTICAL2:

Select the input to which the component has been connected.

#### ▶ -----:

Select if the component is connected to an analog audio input.

### Note

- When an **HDMI IN** is assigned to an input selector in “**HDMI Input**” (→ page 39), the same **HDMI IN** will be set as a priority in this assignment. In this case, if you want to use the coaxial or optical audio input, make the appropriate selection in the “**Audio Selector**” (→ page 43).
- Available sampling rates for PCM signals (stereo/mono) from a digital input (optical and coaxial) are 32/44.1/48/88.2/96 kHz/16, 20, 24 bit.
- The “**TUNER**” selector cannot be assigned and is fixed at the “-----” option.

## Sp Config (Speaker Configuration)



### Menu Sp Config

This section explains how to specify which speakers are connected and their sizes.

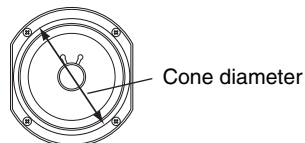

For speakers with a cone diameter larger than 6-1/2 inches (16 cm), specify **Large** (full band). For those with a smaller diameter, specify **Small** (default crossover 120 Hz).

The crossover frequency can be changed in the “Crossover (Crossover Frequency)”.

### Note

- These settings are not available in either of the following cases:
  - A pair of headphones is connected.
  - The “**Audio TV Out**” setting is set to “**On**” (→ page 45).
  - “**HDMI Ctrl (RIHD)**” is set to “**On**” (→ page 45) and you’re listening through your TV speakers.
  - Speakers B is on.
  - Speakers A is off.

### ■ Subwoofer

- ▶ **Yes**
- ▶ **No**

### ■ Front

- ▶ **Small:**
- ▶ **Large:**

Select based on the cone diameter.

### Note

- If the “**Subwoofer**” setting is set to “**No**”, this setting is fixed to “**Large**”.

### ■ Center\*1, Surround\*1

- ▶ **Small:**
- ▶ **Large:**

Select based on the cone diameter.

### ▶ None

### Note

- \*1 If the “**Front**” setting is set to “**Small**”, the “**Large**” option cannot be selected.

### ■ Crossover (Crossover Frequency)

This setting is advantageous for the speakers that you specified as “**Small**” in the “Sp Config (Speaker Configuration)”. To get the best bass performance from your speaker system, you need to set the crossover frequency according to the size and frequency response of your speakers.

- ▶ **40Hz, 50Hz, 60Hz, 70Hz, 80Hz, 90Hz, 100Hz, 120Hz, 150Hz, 200Hz**

Use the diameter of the smallest speaker in your system when choosing the crossover frequency.

Speaker cone diameter	Crossover frequency
Over 8 in. (20 cm)	40/50/60 Hz*2
6-1/2 to 8 in. (16 to 20 cm)	70/80/90 Hz*2
5-1/4 to 6-1/2 in. (13 to 16 cm)	100 Hz
3-1/2 to 5-1/4 in. (9 to 13 cm)	120 Hz
Under 3-1/2 in. (9 cm)	150/200 Hz*2

- \*2 Choose the setting suitable for the speaker.

↳ To be continued





**Note**

- For a more accurate setting, look up the frequency response in the manuals supplied with your speakers and set accordingly.
- Choose a higher crossover frequency if you want more sound from your subwoofer.

**Double Bass**

- ▶ **On**
- ▶ **Off**

Turn this setting on to boost bass output by feeding bass sounds from the front left, right, and center channels to the subwoofer.

**Note**

- When the “**Subwoofer**” setting is set to “**No**” or the “**Front**” setting to “**Small**”, this setting is fixed to “**Off**” (→ [page 40](#)).
- This setting is set to “**On**” automatically when the “**Subwoofer**” and “**Front**” settings are set for the first time to “**Yes**” and “**Large**” respectively.

**Sp Distance (Speaker Distance)****Menu Sp Distance**

Here you can specify the distance from each speaker to the listening position so that the sound from each speaker arrives at the listener’s ears as the sound designer intended.

**Note**

- These settings are not available in either of the following cases:
  - A pair of headphones is connected.
  - The “**Audio TV Out**” setting is set to “**On**” (→ [page 45](#)).
  - “**HDMI Ctrl (RIHD)**” is set to “**On**” (→ [page 45](#)) and you’re listening through your TV speakers.
  - Speakers B is on.
  - Speakers A is off.

**Unit**▶ **feet:**

Distances can be set in feet. Range: **1ft to 30ft** in 1 foot steps.

▶ **meters:**

Distances can be set in meters. Range: **0.3m to 9.0m** in 0.3 meter steps.

(The default setting varies from country to country.)

**Left, Center, Right, Surround Right, Surround Left, Subwoofer**

- ▶ Specify the distance from the each speaker to your listening position.

**Note**

- Speakers that you set to “**No**” or “**None**” in the “Sp Config (Speaker Configuration)” (→ [page 40](#)) cannot be selected.

**Level Cal (Level Calibration)****Menu Level Cal**

Here you can adjust the level of each speaker with the built-in test tone so that the volume of each speaker is the same at the listening position.

**Note**

- These settings cannot be calibrated in either of the following cases:
  - A pair of headphones is connected.
  - The “**Audio TV Out**” setting is set to “**On**” (→ [page 45](#)).
  - “**HDMI Ctrl (RIHD)**” is set to “**On**” (→ [page 45](#)) and you’re listening through your TV speakers.
  - Speakers B is on.
  - Speakers A is off.
  - The AV receiver is muted.

**Left, Center<sup>\*1</sup>, Right, Surround Right, Surround Left**

- ▶ **-12 dB to 0 dB to +12 dB** in 1 dB step.

**Subwoofer<sup>\*1</sup>**

- ▶ **-15 dB to 0 dB to +12 dB** in 1 dB step.

**Note**

- Speakers that you set to “**No**” or “**None**” in the “Sp Config (Speaker Configuration)” (→ [page 40](#)) cannot be selected.

<sup>\*1</sup> For the center speaker and subwoofer, the level settings made by using the Home menu are saved in this menu (→ [page 33](#)).

**Tip**

- If you’re using a handheld sound level meter, adjust the level of each speaker so that it reads 75 dB SPL at the listening position, measured with C-weighting and slow reading.



## Audio Adjust



Menu

Audio Adjust

With the Audio Adjust functions and settings, you can adjust the sound and listening modes as you like.

### Multiplex/Mono

#### ■ Multiplex

##### Input Ch (Mux)

- ▶ Main
- ▶ Sub
- ▶ Main/Sub

This setting determines which channel of a stereo multiplex source is output. Use it to select audio channels or languages with multiplex sources, multilingual TV broadcasts, and so on.

#### ■ Mono

##### Input Ch (Mono)

- ▶ Left + Right
- ▶ Left
- ▶ Right

This setting specifies the channel to be used for playing any 2-channel digital source such as Dolby Digital, or 2-channel analog/PCM source in the Mono listening mode.

### Dolby

#### ■ PL II Music (2ch Input)

These settings apply to only 2-channel stereo sources.

##### Panorama

- ▶ On
- ▶ Off

With this setting, you can broaden the width of the front stereo image when using the Dolby Pro Logic II Music listening mode.

##### Dimension

- ▶ -3 to 0 to +3

With this setting, you can move the sound field forward or backward when using the Dolby Pro Logic II Music listening mode. Higher settings move the sound field backward. Lower settings move it forward.

If the stereo image feels too wide, or there's too much surround sound, move the sound field forward to improve the balance. Conversely, if the stereo image feels like it's in mono, or there's not enough surround sound, move it backward.

##### Center Width

- ▶ 0 to 3 to 7

With this setting, you can adjust the width of the sound from the center speaker when using the Dolby Pro Logic II Music listening mode. Normally, if you're using a center speaker, the center channel sound is output from only the center speaker. (If you're not using a center speaker, the center channel sound will be distributed to the front left and right speakers to create a phantom center). This setting controls the front left, right, and center mix, allowing you to adjust the weight of the center channel sound.

### DTS

#### ■ Neo:6 Music

##### Center Image

- ▶ 0 to 2 to 5

With this setting, you can specify by how much the front left and right channel output is attenuated in order to create the center channel.

Changing the value from "0" to "5" will spread the sound of the center channel to left and right (outwards).

### Theater-Dimensional

#### ■ Listening Angle

##### ▶ Wide:

Select if the listening angle is 40 degrees.

##### ▶ Narrow:

Select if the listening angle is 20 degrees.

With this setting, you can optimize the Theater-Dimensional listening mode by specifying the angle of the front left and right speakers relative to the listening position. Ideally, the front left and right speakers should be equidistant from the listening position and at an angle close to one of the two available settings.

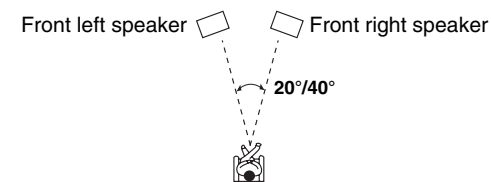

## Source Setup



Items can be set individually for each input selector.

### Preparation

Press the input selector buttons to select an input source.

Menu

Source Setup

## A/V Sync

### A/V Sync

▶ **0 ms** to **400 ms** in 10 msec steps

When using progressive scanning on your Blu-ray Disc/DVD player, you may find that the picture and sound are out of sync. With this setting, you can correct this by delaying the audio signals.

To view the TV picture while setting the delay, press **ENTER**.

To return to the previous screen, press **RETURN**.

The range of values you can adjust will depend on whether your TV supports HDMI Lip Sync and if the “**LipSync**” setting is set to “**On**” or not (→ [page 46](#)).

### Note

- A/V Sync is disabled when the Direct listening mode is used with an analog input source.

## Preset Name For Input Selector

### Name

▶ **---**, Blu-ray, DVD, HD DVD, VCR, DVR, Tivo, CableSTB, SAT STB, PS3, Wii, Xbox, PC, TV, CD, TAPE, iPod:

To reset to the default, select “**---**”.

You can enter a preset name for each individual input selector for easy identification. When entered, the preset name will be displayed.

### Note

- You can't assign the same preset name to multiple input selectors.
- This setting cannot be used for the **AM**, **FM** or **USB** input selector.

## Audio Selector

### Audio Selector

#### ▶ ARC:

The audio signal from your TV tuner can be sent to the **HDMI OUT** of the AV receiver.\*1

With this selection, the TV's audio can be automatically selected as a priority among other assignments.

#### ▶ HDMI:

This can be selected when **HDMI IN** has been assigned as an input source. If both HDMI (**HDMI IN**) and digital audio inputs (**COAXIAL IN** or **OPTICAL IN**) have been assigned, HDMI input is automatically selected as a priority.

#### ▶ COAXIAL:

This can be selected when **COAXIAL IN** has been assigned as an input source. If both coaxial and HDMI inputs have been assigned, coaxial input is automatically selected as a priority.

#### ▶ OPTICAL:

This can be selected when **OPTICAL IN** has been assigned as an input source. If both optical and HDMI inputs have been assigned, optical input is automatically selected as a priority.

#### ▶ Analog:

The AV receiver always outputs analog signals.

You can set priorities of audio output when there are both digital and analog inputs.

### Note

- This setting can be made only for the input source that is assigned as **HDMI IN**, **COAXIAL IN**, or **OPTICAL IN**.

\*1 You can select “**ARC**” if you select the **TV/CD** input selector. But you cannot if you've selected “**Off**” in the “**Audio Return Ch**” setting (→ [page 46](#)).



## Setting the Incoming Digital Signal (Fixed Mode)

### ■ Fixed Mode

#### ▶ Off:

The format is detected automatically. If no digital input signal is present, the corresponding analog input is used instead.

#### ▶ PCM:

Only 2-channel PCM format input signals will be heard. If the input signal is not PCM, the **PCM** indicator will flash and noise may also be produced.

#### ▶ DTS:

Only DTS (but not DTS-HD) format input signals will be heard. If the input signal is not DTS, the **dts** indicator will flash and there will be no sound.

When “**HDMI**”, “**COAXIAL**” or “**OPTICAL**” is selected in the “**Audio Selector**” setting, you can then specify the signal type in “**Fixed Mode**”.

Normally, the AV receiver detects the signal format automatically. However, if you experience either of the following issues when playing PCM or DTS material, you can manually set the signal format to PCM or DTS.

- If the beginnings of tracks from a PCM source are cut off, try setting the format to PCM.
- If noise is produced when fast forwarding or reversing a DTS CD, try setting the format to DTS.

#### Note

- The setting will be reset to “**Off**” when you change the setting in the “**Audio Selector**” (→ [page 43](#)).

## Hardware



## Menu Hardware

### OSD

#### ■ Volume OSD

##### ▶ On

##### ▶ Off

Turn this setting on to display the volume level on the TV screen while it is adjusted.

### Remote ID

#### ■ Remote ID

##### ▶ 1, 2, or 3

When several Onkyo components are used in the same room, their remote ID codes may overlap. To differentiate the AV receiver from the other components, you can change its remote ID from “1”, to “2” or “3”.

#### Note

- If you do change the AV receiver’s remote ID, be sure to change the remote controller to the same ID (see below), otherwise, you won’t be able to control it with the remote controller.

### Changing the remote controller’s ID

- 1 While holding down **RECEIVER**, press and hold down **SETUP** until the remote indicator lights (about 3 seconds).
- 2 Use the number buttons to enter ID 1, 2, or 3. The remote indicator flashes twice.

## Tuner

### ■ AM/FM Freq Step (North American and Brazilian models)

#### ▶ 10kHz/200kHz:

#### ▶ 9kHz/50kHz:

Select the frequency step according to your area.

### ■ AM Freq Step (Asian models)

#### ▶ 10kHz:

#### ▶ 9kHz:

Select the frequency step according to your area.

For AM/FM tuning to work properly, you must specify the AM/FM frequency step used in your area.

#### Note

- When this setting is changed, all radio presets will be deleted.

## Auto Standby

### ■ Auto Standby

#### ▶ Off

#### ▶ On

When “**Auto Standby**” is set to “**On**”, the AV receiver will automatically enter standby mode if there is no operation for 30 minutes with no audio and no video signal input.

“**Auto Standby**” will appear on the AV receiver’s display and OSD 30 seconds before the Auto Standby comes on.

Default setting: **On (Asian models)**, **Off (North American and Brazilian models)**

#### Note

- Set to “**On**”, the Auto Standby function may activate itself during playback with some sources.



## HDMI Setup



Menu

HDMI Setup

### HDMI Ctrl (RIHD)

- ▶ Off
- ▶ On

Turn this setting on to allow **RIHD**-compatible components connected via HDMI to be controlled by the AV receiver (→ [page 60](#)).

#### Note

- When the setting is set to “**On**” and the menu is closed, the names of connected **RIHD**-compatible components and “**RIHD On**” are displayed on the AV receiver. “**Search...**” → “**(name)**” → “**RIHD On**”  
When the AV receiver cannot receive the name of the component, it is displayed as “**Player\*\***” or “**Recorder\*\***”, etc (“**\*\***” shows up and indicates the number of components, when two or more are received).
- When an **RIHD**-compatible component is connected to the AV receiver via an HDMI cable, the name of the connected component is displayed on the AV receiver display. For example, while you are watching TV broadcasting, if you operate a Blu-ray Disc/DVD player (being powered on) with the remote control of the AV receiver, the name of the Blu-ray Disc/DVD player will be displayed on the AV receiver.
- Set it to “**Off**” when a connected piece of equipment is not compatible or it is unclear whether the equipment is compatible or not.
- If operation is not normal when set to “**On**”, change the setting to “**Off**”.
- Refer to the connected component’s instruction manual for details.
- When the “**HDMI Ctrl (RIHD)**” setting is set to “**On**”, the power consumption in standby mode slightly increases. (Depending on the TV status, the AV receiver will enter standby mode as usual.)

- When the source equipment is connected with the **RI** connection, it may malfunction if “**HDMI Ctrl (RIHD)**” is set to “**On**”.

### HDMI Through

- ▶ Off
- ▶ BD/DVD, VCR/DVR, CBL/SAT, GAME, AUX, TV/CD:

Selects the input source for which the HDMI Through function is enabled.

#### ▶ Last:

The HDMI Through function is activated on the input source selected at the time of setting the AV receiver to standby mode.

When enabling the HDMI Through function, regardless of whether the AV receiver is on or in standby, both audio and video streams from an HDMI input will be output to the TV or other components via HDMI connection. In standby mode, the **HDMI THRU** and **HDMI** indicators will light (**HDMI** will be dimly-lit).

This setting is fixed to “**Auto**” automatically when the above “**HDMI Ctrl (RIHD)**” setting is set to “**On**”, resulting in automatic input source selection.

#### Note

- Only the input source assigned to the **HDMI IN** via “**HDMI Input**” is enabled (→ [page 39](#)).
- The power consumption in standby mode will increase during the HDMI Through function; however in the following cases, the power consumption can be saved:
  - The TV is in standby mode.
  - You are watching a TV program.
- Refer to the connected component’s instruction manual for details.
- Depending on the connected component, the correct input source may not be selected with the setting fixed to “**Auto**”.
- This setting is set to “**Off**” automatically when the “**HDMI Ctrl (RIHD)**” setting is set to “**Off**”.

### Audio TV Out

- ▶ Off
- ▶ On

This preference determines whether the incoming audio signal is output from the HDMI output. You may want to turn this preference on if your TV is connected to the HDMI output and you want to listen to the audio from a connected component through your TV’s speakers. Normally, this should be set to “**Off**”.

#### Note

- If “**On**” is selected and the audio can be output from the TV, the AV receiver will output no sound through its speakers. In this case, “**TV Speaker**” appears on the AV receiver’s display by pressing **DISPLAY**.
- When “**HDMI Ctrl (RIHD)**” is set to “**On**”, this setting is fixed to “**Auto**”.
- With some TVs and input signals, no sound may be output even when this setting is set to “**On**”.
- When “**Audio TV Out**” or “**HDMI Ctrl (RIHD)**” is set to “**On**” and you’re listening through your TV’s speakers (→ [page 16](#)), turning up the AV receiver’s volume control will make the sound be output from the AV receiver’s front left and right speakers. To stop the AV receiver’s speakers producing sound, change the settings, change your TV’s settings, or turn down the AV receiver’s volume.
- Listening mode cannot be changed when this setting is set to “**On**” and the input source is not HDMI.



## ■ Audio Return Ch (ARC)

### ▶ Off

### ▶ Auto:

The audio signal from your TV tuner can be sent to the **HDMI OUT** of the AV receiver.

The audio return channel (ARC) function allows an ARC capable TV to send the audio stream to the **HDMI OUT** of the AV receiver. To use this function, you must select the **TV/CD** input selector and your TV must be ARC capable.

### Note

- This setting is fixed to “- - - -” when the “**HDMI Ctrl (RIHD)**” setting is set to “**Off**”.
- This setting is set to “**Auto**” automatically when the “**HDMI Ctrl (RIHD)**” setting is set to “**On**” for the first time.
- If you set “**Audio Return Ch**” to “**Auto**”, the “**Audio Selector**” settings of the **TV/CD** input selector will be automatically switched to “**ARC**” (→ [page 43](#)).

## ■ LipSync

### ▶ Off

### ▶ On

This function allows the AV receiver to automatically correct any delay between the video and the audio, based on the data from the connected monitor.

### Note

- This function works only if your HDMI-compatible TV supports HDMI Lip Sync.

After changing the settings of the “**HDMI Ctrl (RIHD)**”, “**HDMI Through**” or “**Audio Return Ch**” turn off the power on all connected pieces of equipment and then turn them on again. Refer to the user’s manuals for all connected pieces of equipment.

## Using the Audio Settings

You can change various audio settings from the Home menu (→ [page 33](#)).

- 1 Press **RECEIVER** followed by **HOME**.
- 2 Use **▲/▼** and **ENTER** to select “**Audio**”, and then use **▲/▼/◀/▶** to make the desired selection.

### Note

- These settings are not available in either of the following cases:
  - The “**Audio TV Out**” setting is set to “**On**” (→ [page 45](#)).
  - “**HDMI Ctrl (RIHD)**” is set to “**On**” (→ [page 45](#)) and you’re listening through your TV speakers.

## Tone Control

### ■ Bass

▶ **-10 dB to 0 dB to +10 dB** in 2 dB steps

You can boost or cut low-frequency sounds output from the front speakers.

### ■ Treble

▶ **-10 dB to 0 dB to +10 dB** in 2 dB steps

You can boost or cut high-frequency sounds output from the front speakers.

You can adjust the bass and treble for Speakers A and B front speakers, except when the Direct listening mode is selected.

### Operating on the remote controller directly

- 1 Press **RECEIVER** once followed by **TONE** repeatedly to select either “**Bass**” or “**Treble**”.
- 2 Use **-** and **+** to adjust.

### Tip

- Alternatively, you can use the AV receiver’s **TONE** and **-/+**.

## Speaker Levels

### ■ Subwoofer Level

▶ **-15 dB to 0 dB to +12 dB** in 1 dB steps

### Operating on the remote controller directly

- 1 Press **RECEIVER** once followed by **TONE** repeatedly to select “**Subwoofer**”.
- 2 Use **-** and **+** to adjust.

### Tip

- Alternatively, you can use the AV receiver’s **TONE** and **-/+**.

### ■ Center Level

▶ **-12 dB to 0 dB to +12 dB** in 1 dB steps

You can adjust the volume of each speaker while listening to an input source.

These temporary adjustments are cancelled when the AV receiver is set to standby. To save the setting you made here, go to “**Level Cal (Level Calibration)**” (→ [page 41](#)) before setting the AV receiver to standby.

### Note

- These settings cannot be calibrated in either of the following cases:
  - A pair of headphones is connected.
  - The AV receiver is muted.
- Speakers that are set to “**No**” or “**None**” in the “**Sp Config (Speaker Configuration)**” (→ [page 40](#)) cannot be adjusted.



## EX.BASS

---

### ■ EX.BASS

▶ **Off**

▶ **On**

EX.BASS is a technology that have developed by experiments and listening tests to reproduce a natural deeper bass. When you turn the mode on, you can get dynamic and deeper presence on your movies and music.

#### Note

- This setting is not available in either of the following cases:
  - A pair of headphones is connected.
  - Speakers B is on.
  - Speakers A is off.
  - Direct listening mode is selected.
  - The “**Subwoofer**” setting is set to “**No**” (→ [page 40](#)).

## Late Night

---

### ■ Late Night

For **Dolby Digital** and **Dolby Digital Plus** sources, the options are:

▶ **Off**

▶ **Low:**

Small reduction in dynamic range.

▶ **High:**

Large reduction in dynamic range.

For **Dolby TrueHD** sources, the options are:

▶ **Auto:**

The Late Night function is set to “**On**” or “**Off**” automatically.

▶ **Off**

▶ **On**

Turn this setting on to reduce the dynamic range of Dolby Digital material so that you can still hear quiet parts even when listening at low volume levels—ideal for watching movies late at night when you don’t want to disturb anyone.

#### Note

- The effect of the Late Night function depends on the material that you are playing and the intention of the original sound designer, and with some material there will be little or no effect when you select the different options.
- The Late Night function can be used only when the input source is Dolby Digital, Dolby Digital Plus, or Dolby TrueHD.
- The Late Night function is set to “**Off**” when the AV receiver is set to standby. For Dolby TrueHD sources, it will be set to “**Auto**”.

## Music Optimizer

---

### ■ Music Optimizer

▶ **Off**

▶ **On**

The Music Optimizer function enhances the sound quality of compressed music files. The **M.Opt** indicator lights on the AV receiver’s display.

#### Tip

- Alternatively, you can use the AV receiver’s **MUSIC OPTIMIZER**.

#### Note

- The Music Optimizer function only works with PCM digital audio input signals with a sampling rate below 48 kHz and analog audio input signals.
- The Music Optimizer is disabled when the Direct listening mode is selected.
- The setting is stored individually for each input selector.

## CinemaFILTER

---

### ■ Cinema Filter

▶ **Off**

▶ **On**

Turn this setting on to soften overly bright movie soundtracks, which are typically mixed for reproduction in a movie theater.

CinemaFILTER can be used with the following listening modes: Dolby Digital, Dolby Digital Plus, Dolby TrueHD, Dolby Pro Logic II Movie, Multichannel, DTS, DTS Neo:6 Cinema, DTS 96/24, DTS-HD High Resolution Audio, DTS-HD Master Audio and DTS Express.

#### Note

- The CinemaFILTER may not work when used with certain input sources.

# iPod/iPhone Playback via Onkyo Dock

## Using the Onkyo Dock

The Dock is sold separately. Models sold are different depending on the region.

For the latest information on the Onkyo Dock components, see the Onkyo web site at:

<http://www.onkyo.com>

Before using the Onkyo Dock components, update your iPod/iPhone with the latest software, available from the Apple web site.

For supported iPod/iPhone models, see the instruction manual of the Onkyo Dock.

## RI Dock

With the RI Dock, you can easily play the music stored on your Apple iPod/iPhone through the AV receiver and enjoy great sound, and watch iPod/iPhone slideshows and videos on your TV. In addition, the on-screen display (OSD) allows you to view, navigate, and select your iPod/iPhone model's contents on your TV, and with the supplied remote controller, you can control your iPod/iPhone from the comfort of your sofa. You can even use the AV receiver's remote controller to operate your iPod/iPhone.

### Note

- Enter the appropriate remote control code before using the AV receiver's remote controller for the first time (→ [page 50](#)).
- Connect the RI Dock to the AV receiver with an **RI** cable (→ [page 18](#)).
- Set the RI Dock's RI MODE switch to "HDD" or "HDD/DOCK".
- Set the AV receiver's Input Display to "DOCK" (→ [page 35](#)).

## System Function

### System On

When you turn on the AV receiver, the RI Dock and iPod/iPhone turn on automatically. In addition, when RI Dock and iPod/iPhone are on, the AV receiver can be turned on by pressing  $\phi$ .

### Auto Power On

If you press the remote controller's  $\blacktriangleright$  (Playback) while the AV receiver is on standby, the AV receiver will automatically turn on, select your iPod/iPhone as the input source, and your iPod/iPhone will start playback.

### Direct Change

If you start iPod/iPhone playback while listening to another input source, the AV receiver will automatically switch to the input to which RI Dock is connected.

### Other Remote Operations

You can use the remote controller that came with the AV receiver to control other iPod/iPhone functions. The available functionality depends on the AV receiver.

### iPod/iPhone Alarm

If you use the Alarm function on your iPod/iPhone to start playback, the AV receiver will turn on at the specified time and select your iPod/iPhone as the input source automatically.

### Note

- Linked operations do not work with video playback or when the alarm is set to play a sound.
- If you use your iPod/iPhone with any other accessories, iPod/iPhone playback detection may not work.
- The System On function may not work depending on the RI Dock.

## Operating Notes

- Use the AV receiver's volume control to adjust the playback volume.
- While your iPod/iPhone is inserted in the RI Dock, its volume control has no effect.
- If you do adjust the volume control on your iPod/iPhone while it's inserted in the RI Dock, be careful that it's not set too loud before you reconnect your headphones.



## Controlling Your iPod/iPhone

By pressing the **REMOTE MODE** button that's been programmed with the remote control code for your Dock, you can control your iPod/iPhone in the Dock with the buttons described further in this section.

See "Entering Remote Control Codes" for details on entering a remote control code (→ [page 50](#)).

See the Dock's instruction manual for more information.

### RI Dock

- Set the RI Dock's RI MODE switch to "HDD" or "HDD/DOCK".
- $\phi$  may not work with a remote control code (without **RI**). In this case, make an **RI** connection and enter the remote control code **81993** (with **RI**).

#### ■ With the RI Control

Make an **RI** connection and enter the remote control code **81993** (with **RI**).

- Set the AV receiver's Input Display to "DOCK" (→ [page 35](#)).

#### ■ Without the RI Control

You must enter the remote control code **82990** first (→ [page 51](#)).



### ■ RI Dock operation

#### Available buttons

①	$\phi$ *1	⑥	DISPLAY*3
②	TOP MENU*2	⑦	MUTING
③	$\blacktriangle/\blacktriangledown/\blacktriangleleft/\blacktriangleright$ , ENTER	⑧	ALBUM +/-
④	$\blacktriangleright$ , $\blacksquare$ , $\blacktriangleleft$ , $\blacktriangleright$ , $\blacktriangleleft$ , $\blacktriangleright$	⑨	VOL $\blacktriangle/\blacktriangledown$
⑤	REPEAT	⑩	MENU
	RANDOM	⑪	MODE*4

#### Note

- With some iPod/iPhone models, generations and RI Docks, certain buttons may not work as expected.
  - For detailed operation of iPod/iPhone, please refer to the instruction manual of the RI Dock.
- \*1 This button does not turn the Onkyo DS-A2 or DS-A2X RI Dock on or off. Also, your iPod/iPhone may not respond the first time you press this button, in which case you should press it again. This is because the remote controller transmits the On and Standby commands alternately, so if your iPod/iPhone is already on, it will remain on when the remote controller transmits the On command. Similarly, if your iPod/iPhone is already off, it will remain off when the remote controller transmits the Off command.
- \*2 **TOP MENU** works as the mode button when used with the DS-A2 RI Dock.
- \*3 **DISPLAY** turns on backlight for a second.
- \*4 **Resume mode**  
With the Resume function, you can resume playback of the song that was playing when you removed your iPod/iPhone from the RI Dock.



# Controlling Other Onkyo Components

You can use the AV receiver's remote controller to control your other Onkyo AV components. This section explains how to enter the remote control code for a component that you want to control: DVD, CD, etc.

## Preprogrammed Remote Control Codes

The following **REMOTE MODE** buttons are preprogrammed with remote control codes for controlling the components listed. You do not need to enter a remote control code to control these components.

For details on controlling these components, see the indicated pages.

**BD/DVD** Onkyo Blu-ray Disc player (→ [page 52](#))

**TV/CD** Onkyo CD player (→ [page 53](#))

## Entering Remote Control Codes

You'll need to enter a code for each component that you want to control.

- 1 Look up the appropriate remote control code in the Remote Control Codes for Onkyo Components Connected via RI.**
- 2 While holding down the REMOTE MODE button to which you want to assign a code, press and hold down DISPLAY (about 3 seconds).**

The remote indicator lights.

### Note

- Remote control codes cannot be entered for **RECEIVER**.
- Except for **RECEIVER** remote control codes from any category can be assigned to the **REMOTE MODE** button. However, these buttons also work as input selector buttons (→ [page 21](#)), so choose a **REMOTE MODE** button that corresponds with the input to which you connect your component. For example, if you connect your CD player to the CD input, choose **TV/CD** when entering its remote control code.

- 3 Within 30 seconds, use the number buttons to enter the 5-digit remote control code.**

The remote indicator flashes twice.

If the remote control code is not entered successfully, the remote indicator will flash once slowly.

## Remote Control Codes for Onkyo Components Connected via RI

Onkyo components that are connected via **RI** are controlled by pointing the remote controller at the AV receiver, not the component. This allows you to control components that are out of view, in a rack, for example.

- 1 Make sure the Onkyo component is connected with an RI cable and an analog audio cable (RCA).**  
See "Connecting Onkyo RI Components" for details (→ [page 18](#)).
- 2 Enter the appropriate remote control code for a REMOTE MODE button, by referring to the previous section.**
  - ▶ **42157:**  
Onkyo cassette tape deck with **RI**
  - ▶ **81993:**  
Onkyo Dock with **RI**
- 3 Press the REMOTE MODE button, point the remote controller at the AV receiver, and operate the component.**

↳ To be continued



### Controlling Onkyo components without **RI**

If you want to control an Onkyo component by pointing the remote controller directly at it, or you want to control an Onkyo component that's not connected via **RI**, use the following remote control codes:

- ▶ **30627:**  
Onkyo DVD player without **RI**
- ▶ **71817:**  
Onkyo CD player without **RI**
- ▶ **32900/33000:**  
Onkyo Blu-ray Disc player
- ▶ **32901/33004:**  
Onkyo HD DVD player
- ▶ **70868:**  
Onkyo MD recorder without **RI**
- ▶ **71323:**  
Onkyo CD recorder without **RI**
- ▶ **82990:**  
Onkyo Dock without **RI**

### Resetting the **REMOTE MODE** Buttons

You can reset a **REMOTE MODE** button to its default remote control code.

- 1** While holding down the **REMOTE MODE** button that you want to reset, press and hold down **HOME** until the remote indicator lights (about 3 seconds).
- 2** Within 30 seconds, press the **REMOTE MODE** button again.

The remote indicator flashes twice, indicating that the button has been reset.

Each **REMOTE MODE** button is preprogrammed with a remote control code. When a button is reset, its preprogrammed code is restored.

### Resetting the Remote Controller

You can reset the remote controller to its default settings.

- 1** While holding down **RECEIVER**, press and hold down **HOME** until the remote indicator lights (about 3 seconds).
- 2** Within 30 seconds, press **RECEIVER** again.  
The remote indicator flashes twice, indicating that the remote controller has been reset.



## Controlling Other Components

By pressing the **REMOTE MODE** button that's been programmed with the remote control code for your component, you can control Onkyo component as described below.

For details on entering a remote control code for other components, see "Entering Remote Control Codes" (→ [page 50](#)).

### Controlling a Blu-ray Disc/DVD Player, HD DVD Player

**BD/DVD** is preprogrammed with the remote control code for controlling a component that supports the **RIHD**<sup>\*1</sup> (limited to some models). The component must be able to receive remote control commands via **RIHD** and be connected to the AV receiver via HDMI.

Use the following remote control codes:

▶ **32910/33001/31612:**

Blu-ray Disc/DVD player with **RIHD**

\*1 The **RIHD** supported by the AV receiver is the CEC system control function of the HDMI standard.

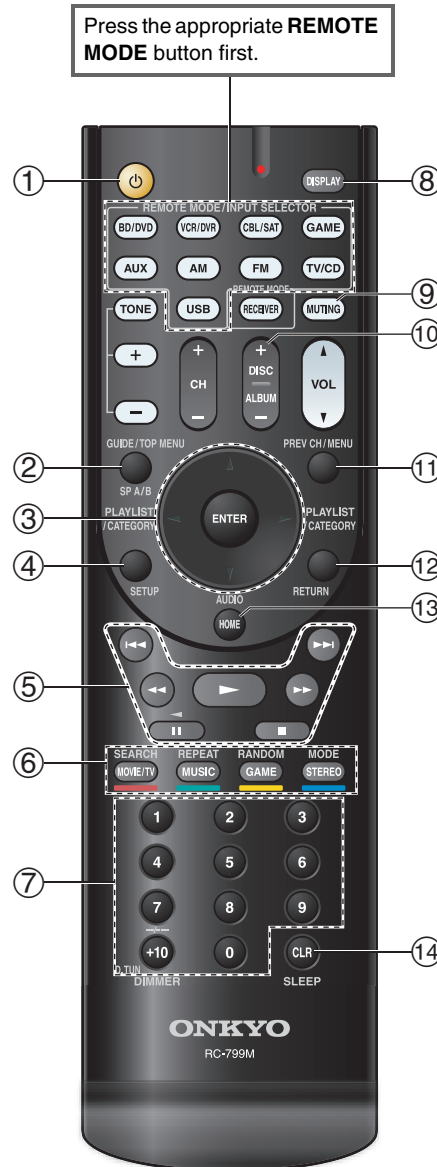

### Blu-ray Disc player / HD-DVD player operation

#### Available buttons

①	Power	⑦	Number: 1 to 9, 0
②	TOP MENU		Number: +10 <sup>*1</sup>
③	▲/▼/◀/▶, ENTER	⑧	DISPLAY
④	SETUP	⑨	MUTING
⑤	▶, II, ■, ◀, ▶▶, ◀◀, ▶▶▶	⑩	DISC +/-
		⑪	MENU
⑥	Red (A)	⑫	RETURN
	Green (B)	⑬	AUDIO <sup>*1</sup>
	Yellow (C)	⑭	CLR
	Blue (D)		

### DVD player operation

#### Available buttons

①	Power	⑦	Number: 1 to 9, 0
②	TOP MENU		Number: +10 <sup>*1</sup>
③	▲/▼/◀/▶, ENTER	⑧	DISPLAY
④	SETUP	⑨	MUTING
⑤	▶, II, ■, ◀, ▶▶, ◀◀, ▶▶▶	⑩	DISC +/-
		⑪	MENU
⑥	SEARCH <sup>*1</sup>	⑫	RETURN
	REPEAT	⑬	AUDIO <sup>*1</sup>
	RANDOM <sup>*1</sup>	⑭	CLR
	MODE <sup>*1</sup>		

Press the appropriate **REMOTE MODE** button first.

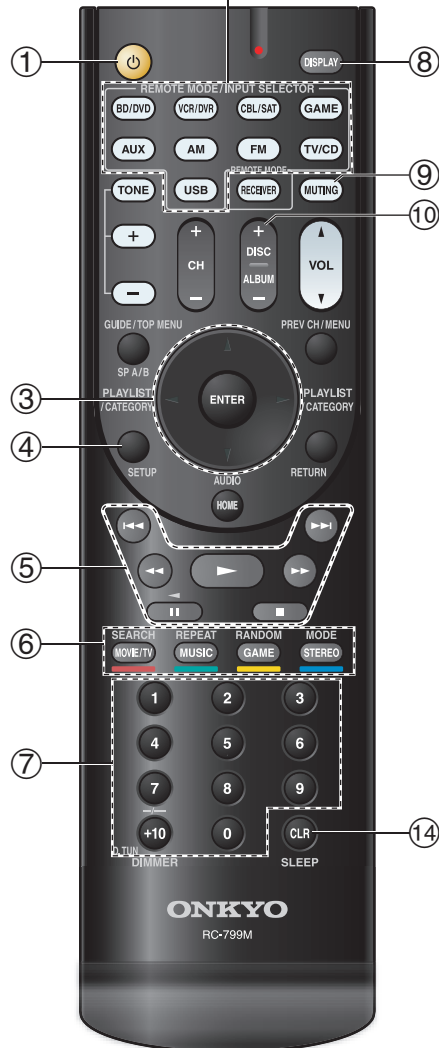

### ■ CD player / CD recorder / MD recorder operation

Available buttons			
①	⏻	⑦	Number: 1 to 9, 0
③	▲/▼/◀/▶, ENTER		Number: +10
④	SETUP	⑧	DISPLAY
⑤	▶,   , ■, ◀◀, ▶▶,  ◀◀, ▶▶	⑨	MUTING
⑥	SEARCH	⑩	DISC +/-
	REPEAT		
	RANDOM		
	MODE		
		⑭	CLR

### ■ Cassette tape deck operation

Available buttons			
①	⏻	⑨	MUTING
⑤	▶, ◀ (reverse playback), ■, ◀◀, ▶▶,  ◀◀, ▶▶		

#### Note

- With some components, certain buttons may not work as expected, and some may not work at all.
- See “Controlling Your iPod/iPhone” about the operation of iPod/iPhone (→ [page 49](#)).
- \*1 The **RIHD** function is not supported. The **RIHD** supported by the AV receiver is the CEC system control function of the HDMI standard.

# Troubleshooting

If you have any trouble using the AV receiver, look for a solution in this section. If you can't resolve the issue yourself, contact your Onkyo dealer.

If you can't resolve the issue yourself, try resetting the AV receiver before contacting your Onkyo dealer.

**To reset the AV receiver to its factory defaults, turn it on and, while holding down VCR/DVR, press  $\odot$  ON/STANDBY. "Clear" will appear on the AV receiver's display and the AV receiver will enter standby mode.**

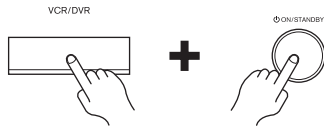

Note that resetting the AV receiver will delete your radio presets and custom settings.

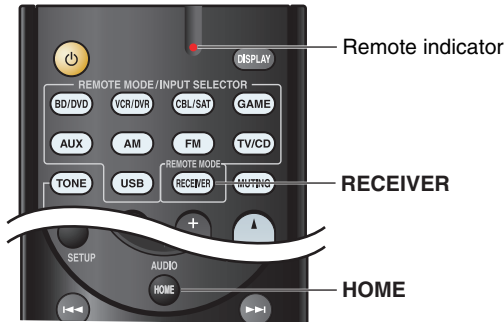

To reset the remote controller to its factory defaults, while holding down **RECEIVER**, press and hold down **HOME** until the remote indicator lights (about 3 seconds). Within 30 seconds, press **RECEIVER** again.

**The on-screen menus appear only on a TV that is connected to the HDMI OUT. If your TV is connected to other video outputs, use the AV receiver's display when changing settings.**

## Power

### ■ Can't turn on the AV receiver

Make sure that the power cord is properly plugged into the wall outlet. —

Unplug the power cord from the wall outlet, wait five seconds or more, then plug it in again. —

### ■ The AV receiver turns off unexpectedly

The AV receiver will automatically enter standby mode when Auto Standby has been set and launches. **44**

### ■ The AV receiver turns off and after restoring the power, it turns off again

The protection circuit has been activated. Remove the power cord from the wall outlet immediately. Make sure that all speaker cables and input sources are properly connected, and leave the AV receiver with its power cord disconnected for 1 hour. After that, reconnect the power cord and turn the power on. If the AV receiver turns off again, unplug the power cord and contact your Onkyo dealer. **14**  
Caution: If "CHECK SP WIRE" appears on the AV receiver's display, the speaker cables may be shorting.

#### WARNING

If smoke, smell or abnormal noise is produced by the AV receiver, unplug the power cord from the wall outlet immediately and contact your Onkyo dealer.

## Audio

### ■ There's no sound, or it's very quiet

Press **SPEAKERS A** or **B** to turn on the speaker indicator that you want to output sound. **33**

Make sure that the digital input source is selected properly. **40**

Make sure that all audio connecting plugs are pushed in all the way. **15**

Make sure that the inputs and outputs of all components are connected properly. **16-18**

Make sure that the polarity of the speaker cables is correct, and that the bare wires are in contact with the metal part of each speaker terminal. **14**

Make sure that the input source is properly selected. **21**

Make sure that the speaker cables are not shorting. **14**

Check the volume. The AV receiver is designed for home theater enjoyment. It has a wide volume range, allowing precise adjustment. —

If the **MUTING** indicator is flashing on the AV receiver's display, press the remote controller's **MUTING** to unmute the AV receiver. **35**

While a pair of headphones is connected to the **PHONES** jack, no sound is output from the speakers. **36**

If there's no sound from a DVD player connected to an HDMI IN, check the DVD player's output settings, and be sure to select a supported audio format. —

Check the digital audio output setting on the connected device. On some game consoles, such as those that support DVD, the default setting is off. —

With some DVD-Video discs, you need to select an audio output format from a menu. —

If your turntable uses an MC cartridge, you must connect an MC head amp, or an MC transformer. —

Make sure that none of the connecting cables are bent, twisted, or damaged. —

Not all listening modes use all speakers. **29**

Specify the speaker distances and adjust the individual speaker levels. **41**



If the input signal format is set to “PCM” or “DTS”. **44**  
Set it to “Off”.

### ■ Only the front speakers produce sound

When the Stereo or Mono listening mode is selected, **31**  
only the front speakers and subwoofer produce  
sound.

Check the Speaker Configuration. **40**

### ■ Only the center speaker produces sound

If you use the Dolby Pro Logic II Movie, Dolby Pro **—**  
Logic II Music, or Dolby Pro Logic II Game listening  
mode with a mono source, such as an AM radio  
station or mono TV program, the sound is  
concentrated in the center speaker.

Make sure the speakers are configured correctly. **40**

### ■ The surround speakers produce no sound

When the T-D (Theater-Dimensional), Stereo or **—**  
Mono listening mode is selected, the surround  
speakers produce no sound.

Depending on the source and current listening mode, **28**  
not much sound may be produced by the surround  
speakers. Try selecting another listening mode.

Make sure the speakers are configured correctly. **40**

### ■ The center speaker produces no sound

When the Stereo or Mono listening mode is selected, **—**  
the center speaker produces no sound.

Make sure the speakers are configured correctly. **40**

### ■ The subwoofer produces no sound

The subwoofer outputs no sound while only Speakers **33**  
B is on. Turn on Speakers A.

When you play source material that contains no **—**  
information in the LFE channel, the subwoofer  
produces no sound.

Make sure the speakers are configured correctly. **40**

### ■ There's no sound with a certain signal format

Check the digital audio output setting on the **—**  
connected device. On some game consoles, such as  
those that support DVD, the default setting is off.

With some DVD-Video discs, you need to select an **—**  
audio output format from a menu.

Depending on the input signal, some listening modes **29-30**  
cannot be selected.

### ■ Can't get 5.1 playback

When Speaker B is turned on, Speakers A is reduced **33**  
to 2.1-channel playback.

Depending on the number of connected speakers, it is **29-30**  
not always possible to select all of the listening  
modes.

### ■ The speaker volume cannot be set as required

After the volume level of each individual speaker has **41**  
been adjusted, the maximum volume may be reduced.

### ■ Noise can be heard

Using cable ties to bundle audio cables with power **—**  
cords, speaker cables, and the like may degrade the  
audio performance, so refrain from doing it.

An audio cable may be picking up interference. Try **—**  
repositioning your cables.

### ■ The Late Night function doesn't work

Make sure the source material is Dolby Digital, **47**  
Dolby Digital Plus, or Dolby TrueHD.

### ■ About DTS signals

When DTS program material ends and the DTS **—**  
bitstream stops, the AV receiver remains in DTS  
listening mode and the **dts** indicator remains on. This  
is to prevent noise when you use the pause, fast  
forward, or fast reverse function on your player. If  
you switch your player from DTS to PCM, because  
the AV receiver does not switch formats  
immediately, you may not hear any sound, in which  
case you should stop your player for about three  
seconds, and then resume playback.

With some CD and LD players, you won't be able to **—**  
playback DTS material properly even though your  
player is connected to a digital input on the AV  
receiver. This is usually because the DTS bitstream  
has been processed (e.g., output level, sampling rate,  
or frequency response changed) and the AV receiver  
doesn't recognize it as a genuine DTS signal. In such  
cases, you may hear noise.

Playing DTS program material, using the pause, fast **—**  
forward, or fast reverse function on your player may  
produce a short audible noise. This is not a  
malfunction.

### ■ The beginning of audio received by an HDMI IN can't be heard

Since it takes longer to identify the format of an **—**  
HDMI signal than it does for other digital audio  
signals, audio output may not start immediately.

## Video

### ■ There's no picture

Make sure that all video connecting plugs are pushed in all the way. **15**

Make sure that each video component is properly connected. **16, 18**

If the video source is connected to a component video input, you must assign that input to an input selector, and your TV must be connected to **COMPONENT VIDEO OUT**. **17, 39**

If the video source is connected to a composite video input, your TV must be connected to the corresponding composite video output. **17**

If the video source is connected to an HDMI input, you must assign that input to an input selector, and your TV must be connected to the **HDMI OUT**. **16, 39**

On your TV, make sure that the video input to which the AV receiver is connected is selected. —

### ■ There's no picture from a source connected to an HDMI IN

Reliable operation with an HDMI-to-DVI adapter is not guaranteed. In addition, video signals from a PC are not guaranteed. **62**

### ■ The on-screen menus don't appear

On your TV, make sure that the video input to which the AV receiver is connected is selected. —

When the AV receiver is not connected to a TV via **HDMI OUT**, on-screen menus are not displayed. —

## Tuner

### ■ Reception is noisy, FM stereo reception is noisy, or the FM STEREO indicator doesn't light

Relocate your antenna. —

Move the AV receiver away from your TV or computer. —

Listen to the station in mono. **25**

When listening to an AM station, operating the remote controller may cause noise. —

Passing cars and airplanes can cause interference. —

Concrete walls weaken radio signals. —

If nothing improves the reception, install an outdoor antenna. —

## Remote Controller

### ■ The remote controller doesn't work

Before operating this unit, be sure to press **RECEIVER**. —

Make sure that the batteries are installed with the correct polarity. **5**

Install new batteries. Don't mix different types of batteries, or old and new batteries. **5**

Make sure that the remote controller is not too far away from the AV receiver, and that there's no obstruction between the remote controller and the AV receiver's remote control sensor. **5**

Make sure that the AV receiver is not subjected to direct sunshine or inverter-type fluorescent lights. Relocate if necessary. —

If the AV receiver is installed in a rack or cabinet with colored-glass doors, the remote controller may not work reliably when the doors are closed. —

Make sure you've selected the correct remote controller mode. **11, 50**

Make sure you've entered the correct remote control code. **50**

Make sure to set the same ID on both the AV receiver and remote controller. **44**

### ■ Can't control other components

If it's an Onkyo component, make sure that the **RI** cable and analog audio cable are connected properly. Connecting only an **RI** cable won't be enough. **18**

Make sure you've selected the correct remote controller mode. **11, 52**

For a proper operation of the remote controller as a cassette tape deck is connected to the **TV/CD IN** jack, or as an **RI Dock** is connected to the **TV/CD IN**, **VCR/DVR IN** or **GAME IN** jacks, you must set the input display accordingly. **35**

If you cannot operate it, you will need to enter the appropriate remote control code. **50**

To control an Onkyo component that's connected via **RI**, point the remote controller at the AV receiver. Be sure to enter the appropriate remote control code first. **50**

To control an Onkyo component that's not connected via **RI**, point the remote controller at the component. Be sure to enter the appropriate remote control code first. **51**

## RI Dock for iPod/iPhone

### ■ There's no sound

Make sure your iPod/iPhone is actually playing. —

Make sure your iPod/iPhone is properly inserted in the Dock. —

Make sure the AV receiver is turned on, the correct input source is selected, and the volume is turned up. —

Make sure the plugs are pushed in all the way. —

Try resetting your iPod/iPhone. —

### ■ There's no video

Make sure that your iPod/iPhone model's TV OUT setting is set to On. —

Make sure the correct input is selected on your TV or the AV receiver. —

Some versions of the iPod/iPhone do not output video. —





## ■ The AV receiver's remote controller doesn't control my iPod/iPhone

Make sure your iPod/iPhone is properly inserted in the Dock. If your iPod/iPhone is in a case, it may not connect properly to the Dock. Always remove your iPod/iPhone from the case before inserting it into the Dock. —

The iPod/iPhone cannot be operated while it's displaying the Apple logo. —

Make sure you've selected the right remote mode. **49**

When you use the AV receiver's remote controller, point it toward your AV receiver. —

If you still can't control your iPod/iPhone, start playback by pressing your iPod/iPhone model's Play button. Remote operation should then be possible. —

Try resetting your iPod/iPhone. —

Depending on your iPod/iPhone, some buttons may not work as expected. —

## ■ The AV receiver unexpectedly selects my iPod/iPhone as the input source

Always pause iPod/iPhone playback before selecting a different input source. If playback is not paused, the Direct Change function may select your iPod/iPhone as the input source by mistake during the transition between tracks. —

## ■ iPod/iPhone doesn't work properly

Try reconnecting your iPod/iPhone. —

## Recording

### ■ Can't record

On your recorder, make sure the correct input is selected. —

To prevent signal loops and damage to the AV receiver, input signals are not fed through to outputs with the same name (e.g., **VCR/DVR IN** to **VCR/DVR OUT**). —

## USB Device Playback

### ■ Can't access the music files on a USB device

Make sure the USB device is plugged in properly. —

The AV receiver supports USB devices that support the USB mass storage device class. However, playback may not be possible with some USB devices even if they conform to the USB mass storage device class. **63**

USB memory devices with security functions cannot be played. **24**

## Others

### ■ Standby power consumption

In the following cases, the power consumption in standby mode may reach up to a maximum of 31 W: **45**

- “**HDMI Ctrl (RIHD)**” setting is set to “**On**”.

(Depending on the TV status, the AV receiver will enter standby mode as usual.)

- The “**HDMI Through**” setting is set to other than “**Off**”.

### ■ The sound changes when I connect my headphones

When a pair of headphones is connected, the listening mode is set to Stereo, unless it's already set to Stereo, Mono, or Direct. —

### ■ How do I change the language of a multiplex source

Use the “**Input Ch (Mux)**” setting on the “**Audio Adjust**” menu to select “**Main**” or “**Sub**”. **42**

### ■ The RI functions don't work

To use **RI**, you must make an **RI** connection and an analog audio connection (RCA) between the component and AV receiver, even if they are connected digitally. **18**

### ■ The following settings can be made for the composite video inputs

You must use the buttons on the unit to make these settings.

On the AV receiver, press the input selector for the input source that you want to set and the **SETUP** button simultaneously. While holding down the input selector button, press **SETUP** until “**Video ATT :On**” appears on the AV receiver's display. Then, release both buttons. To turn the setting off, repeat the above process so that “**Video ATT :Off**” appears on the AV receiver's display, and release the buttons.

#### • Video Attenuation

This setting can be made for the **BD/DVD**, **VCR/DVR**, **CBL/SAT**, **GAME**, **AUX**, or **USB** input.

If you have a games console connected to the composite video input, and the picture isn't very clear, you can attenuate the gain.

**Video ATT :Off:** (default).

**Video ATT :On:** Gain is reduced by 2 dB.

### ■ If the picture on your TV/monitor connected to the HDMI OUT is unstable, try switching the DeepColor function off

To turn off the DeepColor function, simultaneously press the **CBL/SAT** and **ON/STANDBY** buttons on the AV receiver. While holding down **CBL/SAT**, press **ON/STANDBY** until “**Deep Color: Off**” appears on the AV receiver's display. Then, release both buttons. To reactivate the DeepColor function, repeat the above process until “**Deep Color: On**” appears on the AV receiver's display and release the buttons.

The AV receiver contains a microcomputer for signal processing and control functions. In very rare situations, severe interference, noise from an external source, or static electricity may cause it to lockup. In the unlikely event that this happens, unplug the power cord from the wall outlet, wait at least five seconds, and then plug it back in.

Onkyo is not responsible for damages (such as CD rental fees) due to unsuccessful recordings caused by the unit's malfunction. Before you record important data, make sure that the material will be recorded correctly.

Before disconnecting the power cord from the wall outlet, set the AV receiver to standby.

# Connection Tips and Video Signal Path

The AV receiver supports several connection formats for compatibility with a wide range of AV equipment. The format you choose will depend on the formats supported by your components. Use the following sections as a guide.

**The on-screen menus appear only on a TV that is connected to the HDMI OUT. If your TV is connected to other video outputs, use the AV receiver's display when changing settings.**

## Note

- The on-screen setup menus are displayed when:
  - There is no video input, or
  - The video input is 480p, 576p, 720p, 1080i, or 1080p.

## Video Connection Formats

Video components can be connected by using any one of the following video connection formats: composite video, component video, or HDMI, the latter offering the best picture quality.

When choosing a connection format, bear in mind that the AV receiver doesn't convert between formats, so only outputs of the same format as the input will output the signal.

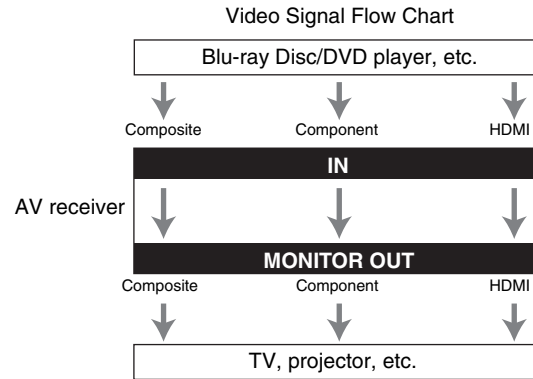

## Audio Connection Formats

Audio components can be connected by using any of the following audio connection formats: analog, optical, coaxial, or HDMI.

When choosing a connection format, bear in mind that the AV receiver does not convert digital input signals for analog line outputs and vice versa. For example, audio signals connected to an optical or coaxial digital input are not output by the analog **VCR/DVR OUT**.

If signals are present at more than one input, the inputs will be selected automatically in the following order of priority: HDMI, digital, analog.

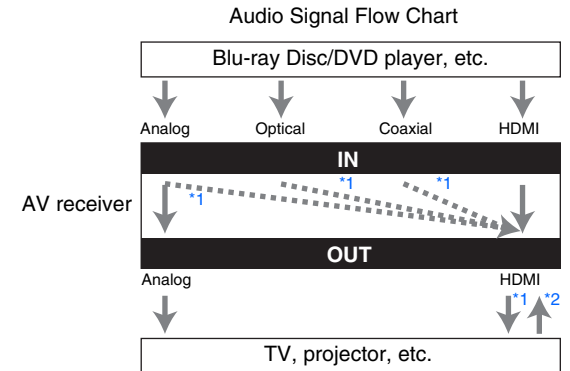

\*1 Depends on the “Audio TV Out” setting (→ [page 45](#)).

\*2 This is possible, when “Audio Return Ch” is set to “Auto” (→ [page 46](#)), the **TV/CD** input selector is selected, and your TV is ARC capable.

## Tip

- When a signal is input via HDMI and the corresponding input selector is selected, the **HDMI** indicator lights.

# Using an RIHD-compatible TV, Player, or Recorder

**RIHD**, which stands for Remote Interactive over HDMI, is the name of the system control function found on Onkyo components. The AV receiver can be used with CEC (Consumer Electronics Control), which allows system control over HDMI and is part of the HDMI standard. CEC provides interoperability between various components, however, operation with components other than **RIHD**-compatible components cannot be guaranteed.

## About RIHD-compatible components

The following components are **RIHD**-compatible (As of January 2012).

### ■ TV

- Toshiba TV
- Sharp TV

### ■ Players/Recorders

- Onkyo and Integra **RIHD**-compatible players
- Toshiba players and recorders (only when used together with Toshiba TV)
- Sharp players and recorders (only when used together with Sharp TV)

\* Models other than those mentioned above may have some interoperability if compatible with CEC which is part of the HDMI Standard, but operation cannot be guaranteed.

### Note

- For proper linked operations, do not connect more **RIHD**-compatible components than the quantities specified below, to the HDMI input terminal.
  - Blu-ray Disc/DVD players: up to three.
  - Blu-ray Disc/DVD recorders/Digital Video Recorders: up to three.
  - Cable/Satellite Set-top boxes: up to four.
- Do not connect the AV receiver to the other AV receiver/AV amplifier via HDMI.
- Proper linked operations are not guaranteed when more **RIHD**-compatible components than the above-mentioned quantities are connected.

## Operations that can be performed with RIHD connection

### ■ For RIHD-compatible TV

The following linked operations are enabled by connecting the AV receiver to an **RIHD**-compatible TV.

- The AV receiver will enter standby mode when the power of the TV is turned to standby.
- You can set on the menu screen of the TV to either output the audio from the speakers connected to the AV receiver, or from the speakers of the TV.
- It is possible to output the video/audio coming from the antenna or from the input jack of the TV from the speakers connected to the AV receiver. (A connection such as optical digital cable or similar is required above the HDMI cable.)
- Input to the AV receiver can be selected with the remote controller of the TV.
- Operations such as volume adjustment or similar for the AV receiver can be performed from the remote controller of the TV.

### ■ For RIHD-compatible players/recorders

The following linked operations are enabled by connecting the AV receiver to an **RIHD**-compatible player/recorder.

- When the playback is started on the player/recorder, input of the AV receiver will switch to the HDMI input of the player/recorder that is playing back.
- Operation of the player/recorder is possible using the remote controller supplied with the AV receiver.

\* Depending on the model used, not all operations may be available.

↳ To be continued



## ■ How to connect and setup

### 1 Confirm the connecting and setting.

1. Connect the **HDMI OUT** jack to the HDMI input jack of the TV.

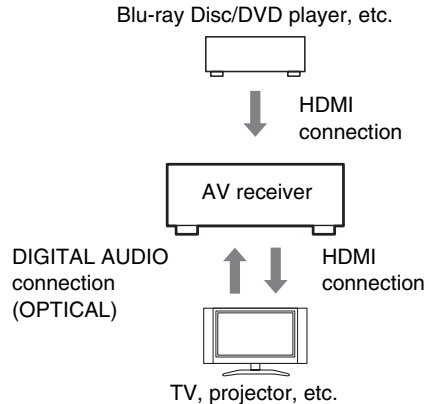

2. Connect the audio output from the TV to the **OPTICAL IN 2** jack of the AV receiver using an optical digital cable.

#### Note

- When the audio return channel (ARC) function is used with an ARC capable TV, this connection is not necessary (→ [page 46](#)).
3. Connect the HDMI output of the Blu-ray Disc/DVD player/recorder to the **HDMI IN 1** jack of the AV receiver.

#### Note

- It is necessary to assign the HDMI input when connecting the Blu-ray Disc/DVD player/recorder to other jacks (→ [page 39](#)). Do not assign the components connected to the HDMI IN to the TV/CD input at this time. Appropriate CEC (Consumer Electronics Control) operation can not be guaranteed.

### 2 Change each item in the “HDMI Setup” menu according to the following settings:

- **HDMI Ctrl (RIHD): On**
- **Audio Return Ch (ARC): Auto**

See details of each setting (→ [pages 45, 46](#)).

### 3 Confirm the settings.

1. Turn on the power for all connected components.
2. Turn off the power of the TV, and confirm that the power of the connected components is turned off automatically with the link operation.
3. Turn on the power of the Blu-ray Disc/DVD player/recorder.
4. Start playback on the Blu-ray Disc/DVD player/recorder, and verify the following.
  - The AV receiver automatically turns on, and selects the input to which the Blu-ray Disc/DVD player/recorder is connected.
  - The TV automatically turns on, and selects the input to which the AV receiver is connected.
5. Following the operating instructions of the TV, select “Use the TV speakers” from the menu screen of the TV, and confirm that the audio is output from the speakers of the TV, and not from the speakers connected to the AV receiver.
6. Select “Use the speakers connected from the AV receiver” from the menu screen of the TV, and confirm that the audio is output from the speakers connected to the AV receiver, and not from the TV speakers.

#### Note

- Perform the above operations when you use the AV receiver for the first time, when the settings of each component are changed, when the main power of each component is turned off, when the power cable is disconnected from the power supply, or when there has been a power outage.

### 4 Operate with the remote controller.

For buttons that can be operated (→ [page 50](#)).

#### Note

- Audio from DVD-Audio or Super Audio CD may not output from the TV speakers. You will be able to output the audio from the TV speakers by setting the audio output of the DVD player to 2ch PCM. (It may not be possible depending on the player models.)
- Even if you set to output audio on the TV speakers, audio will be output from the speakers connected to the AV receiver when you adjust the volume or switch the input on the AV receiver. To output audio from the TV speakers, redo the operations on the TV.
- In case of an **RIHD** connection with **RI** and **RI** audio control compatible components, do not connect the **RI** cable at the same time.
- On the TV, when you select anything other than the HDMI jack to which the AV receiver is connected, the input on the AV receiver will be switched to “**TV/CD**”.
- The AV receiver will automatically power on in conjunction when it determines it to be necessary. Even if the AV receiver is connected to an **RIHD** compatible TV or player/recorder, it will not power on if it is not necessary. It may not power on in conjunction when the TV is set to output audio from the TV.
- Linked functions with the AV receiver may not work depending on the component model connected. In such cases, operate the AV receiver directly.

# About HDMI

Designed to meet the increased demands of digital TV, HDMI (High Definition Multimedia Interface) is a new digital interface standard for connecting TVs, projectors, Blu-ray Disc/DVD players, set-top boxes, and other video components. Until now, several separate video and audio cables have been required to connect AV components.

With HDMI, a single cable can carry control signals, digital video, and up to eight channels of digital audio (2-channel PCM, multichannel digital audio, and multichannel PCM).

The HDMI video stream (i.e., video signal) is compatible with DVI (Digital Visual Interface)\*<sup>1</sup>, so TVs and displays with a DVI input can be connected by using an HDMI-to-DVI adapter cable. (This may not work with some TVs and displays, resulting in no picture.)

The AV receiver uses HDCP (High-bandwidth Digital Content Protection)\*<sup>2</sup>, so only HDCP-compatible components can display the picture.

The AV receiver's HDMI interface is based on the following:

Audio Return Channel, 3D, x.v.Color, DeepColor, Lip Sync, DTS-HD Master Audio, DTS-HD High Resolution Audio, Dolby TrueHD, Dolby Digital Plus, DSD and Multichannel PCM.

## Supported Audio Formats

- 2-channel linear PCM (32–192 kHz, 16/20/24 bit)
- Multichannel linear PCM (up to 7.1 ch, 32–192 kHz, 16/20/24 bit)
- Bitstream (DSD, Dolby Digital, Dolby Digital Plus, Dolby TrueHD, DTS, DTS-HD High Resolution Audio, DTS-HD Master Audio)

Your Blu-ray Disc/DVD player must also support HDMI output of the above audio formats.

## About Copyright Protection

The AV receiver supports HDCP (High-bandwidth Digital Content Protection)\*<sup>2</sup>, a copy-protection system for digital video signals. Other devices connected to the AV receiver via HDMI must also support HDCP.

\*<sup>1</sup> DVI (Digital Visual Interface): The digital display interface standard set by the DDWG\*<sup>3</sup> in 1999.

\*<sup>2</sup> HDCP (High-bandwidth Digital Content Protection): The video encryption technology developed by Intel for HDMI/DVI. It's designed to protect video content and requires a HDCP-compatible device to display the encrypted video.

\*<sup>3</sup> DDWG (Digital Display Working Group): Lead by Intel, Compaq, Fujitsu, Hewlett Packard, IBM, NEC, and Silicon Image, this open industry group's objective is to address the industry's requirements for a digital connectivity specification for high-performance PCs and digital displays.

### Note

- The HDMI video stream is compatible with DVI (Digital Visual Interface), so TVs and displays with a DVI input can be connected by using an HDMI-to-DVI adapter cable. (Note that DVI connections only carry video, so you'll need to make a separate connection for audio.) However, reliable operation with such an adapter is not guaranteed. In addition, video signals from a PC are not supported.
- The HDMI audio signal (sampling rate, bit length, etc.) may be restricted by the connected source component. If the picture is poor or there's no sound from a component connected via HDMI, check its setup. Refer to the connected component's instruction manual for details.



# USB Features

## USB Device Requirements

- USB mass storage device class (but not always guaranteed).
- FAT16 or FAT32 file system format.
- Up to 255 folders can be displayed, and folders may be nested up to 8 levels deep.
- USB hubs and USB devices with hub functions are not supported.

### Note

- If the media you connect is not supported, the message “No Storage” will be displayed.
- If you connect a USB hard disk drive to the AV receiver’s **USB** port, we recommend that you use its AC adapter to power it.
- The AV receiver supports USB MP3 players that support the USB Mass Storage Class standard, which allows USB devices to be connected to computers without the need for special drivers or software. Note that not all USB MP3 players support the USB Mass Storage Class standard. Refer to your USB MP3 player’s instruction manual for details.
- Protected WMA music files on an MP3 player cannot be played.
- Onkyo accepts no responsibility whatsoever for the loss or damage to data stored on a USB device when that device is used with the AV receiver. We recommend that you back up your important music files beforehand.
- MP3 players containing music files that are managed with special music software are not supported.
- Operation is not guaranteed for all USB devices, which includes the ability to power them.
- Do not connect your USB device via a USB hub. The USB device must be connected directly to the AV receiver’s **USB** port.
- If the USB device contains a lot of data, the AV receiver may take a while to read it.
- USB devices with security functions cannot be played.

## Supported Audio File Formats

For playback from a USB device, the AV receiver supports the following music file formats.

Variable bit-rate (VBR) files are supported. However, playback time may not be display correctly.

### ■ MP3 (.mp3 or .MP3)

- MP3 files must be MPEG-1/MPEG-2.5 Audio Layer 3 format with a sampling rate of 8 kHz, 11.025 kHz, 12 kHz, 16 kHz, 22.05 kHz, 24 kHz, 32 kHz, 44.1 kHz, 48 kHz and bitrates of between 8 kbps and 320 kbps. Incompatible files cannot be played.

### ■ WMA (.wma or .WMA)

WMA stands for Windows Media Audio and is an audio compression technology developed by Microsoft Corporation. Audio can be encoded in WMA format by using Windows Media® Player.

- WMA files must have the copyright option turned off.
- Sampling rates of 32 kHz, 44.1 kHz, 48 kHz, bitrates of between 48 kbps and 320 kbps are supported.
- WMA DRM/Pro/Voice formats are not supported.

### ■ AAC (.aac/.m4a/.mp4/.AAC/.M4A or .MP4)

AAC stands for MPEG-2/MPEG-4 Audio.

- Sampling rates of 16 kHz, 22.05 kHz, 24 kHz, 32 kHz, 44.1 kHz, 48 kHz and bitrates of between 8 kbps and 320 kbps are supported.

### ■ FLAC (.flac or .FLAC)

FLAC is a file format for lossless audio data compression.

- Sampling rates of 32 kHz, 44.1 kHz and 48 kHz are supported.
- Quantization bit: 16 bit, 24 bit



# License and Trademark Information

---

“x.v.Color” is a trademark of Sony Corporation.

---



Manufactured under license under U.S. Patent Nos: 5,956,674; 5,974,380; 6,226,616; 6,487,535; 7,212,872; 7,333,929; 7,392,195; 7,272,567 & other U.S. and worldwide patents issued & pending. DTS-HD, the Symbol, & DTS-HD and the Symbol together are registered trademarks of DTS, Inc. Product includes software. © DTS, Inc. All Rights Reserved.

---



Manufactured under license from Dolby Laboratories. Dolby, Pro Logic and the double-D symbol are trademarks of Dolby Laboratories.

---

Music Optimizer™ is a trademark of Onkyo Corporation.

---



“HDMI, the HDMI Logo, and High-Definition Multimedia Interface are trademarks or registered trademarks of HDMI Licensing LLC in the United States and other countries.”

---



iPhone, iPod, iPod classic, iPod nano, iPod shuffle, and iPod touch are trademarks of Apple Inc., registered in the U.S. and other countries.

“Made for iPod” and “Made for iPhone” mean that an electronic accessory has been designed to connect specifically to iPod or iPhone, respectively, and has been certified by the developer to meet Apple performance standards. Apple is not responsible for the operation of this device or its compliance with safety and regulatory standards.

Please note that the use of this accessory with iPod or iPhone may affect wireless performance.

---



# Specifications

## Amplifier Section

<b>Rated Output Power</b> All channels:	(North American and Brazilian) <b>110 watts minimum continuous power per channel, 6 ohm loads, 1 channel driven at 1 kHz, with a maximum total harmonic distortion of 1% (FTC)</b> (Asian) 6 ch × 100 W at 6 ohms, 1 kHz, 1 ch driven of 1 % (IEC)
<b>Maximum Effective Output Power</b> (Asian)	6 ch × 120 W at 6 ohms, 1 kHz, 1 ch driven (JEITA)
<b>Dynamic Power*</b> * IEC60268-Short-term maximum output power	160 W (3 Ω, Front) 125 W (4 Ω, Front) 85 W (8 Ω, Front)
<b>THD+N (Total Harmonic Distortion+Noise)</b>	0.08% (20 Hz - 20 kHz, half power)
<b>Damping Factor</b>	60 (Front, 1 kHz, 8 Ω)
<b>Input Sensitivity and Impedance (Unbalance)</b>	200 mV/47 kΩ (LINE)
<b>Rated RCA Output Level and Impedance</b>	200 mV/2.2 kΩ (REC OUT)
<b>Maximum RCA Output Level and Impedance</b>	2 V/2.2 kΩ (REC OUT)
<b>Frequency Response</b>	5 Hz - 100 kHz/+1 dB, -3 dB (DSP bypass)
<b>Tone Control Characteristics</b>	±10 dB, 50 Hz (BASS) ±10 dB, 20 kHz (TREBLE)
<b>Signal to Noise Ratio</b>	100 dB (LINE, IHF-A)
<b>Speaker Impedance</b>	6 Ω - 16 Ω

## Video Section

<b>Input Sensitivity/Output Level and Impedance</b>	1 Vp-p/75 Ω (Component Y) 0.7 Vp-p/75 Ω (Component Pb/Cb, Pr/Cr) 1 Vp-p/75 Ω (Composite)
<b>Component Video Frequency Response</b>	5 Hz - 100 MHz/+0 dB, -3 dB

## Tuner Section

<b>FM Tuning Frequency Range</b> (North American and Brazilian)	87.5 MHz - 107.9 MHz
(Asian)	87.5 MHz - 108.0 MHz, RDS
<b>AM Tuning Frequency Range</b>	522/530 kHz - 1611/1710 kHz
<b>Preset Channel</b>	40

## General

<b>Power Supply</b>	(North American and Brazilian) AC 120 V, 60 Hz (Asian) AC 220 - 240 V, 50/60 Hz
<b>Power Consumption</b>	(North American and Brazilian) 3.7 A (Asian) 370 W
<b>No-sound Power Consumption</b>	(North American and Brazilian) 40 W (Asian) 35 W (230 V) 40 W (240 V)
<b>Stand-by Power Consumption</b>	(North American and Brazilian) 0.2 W (Asian) 0.3 W
<b>Dimensions (W × H × D)</b>	435 mm × 150 mm × 318 mm 17-1/8" × 5-7/8" × 12-1/2"
<b>Weight</b>	(North American and Brazilian) 7.6 kg (16.8 lbs.) (Asian) 7.8 kg (17.2 lbs.)

## HDMI

<b>Input</b>	IN 1, IN 2, IN 3, IN 4
<b>Output</b>	OUT
<b>Video Resolution</b>	1080p
<b>Audio Format</b>	Dolby TrueHD, DTS-HD Master Audio, DVD-Audio, DSD
<b>Supported</b>	3D, Audio Return Channel, DeepColor, x.v.Color, LipSync, CEC (RIHD)

## Video Inputs

<b>Component</b>	IN 1, IN 2
<b>Composite</b>	BD/DVD, VCR/DVR, CBL/SAT, GAME, AUX

## Video Outputs

<b>Component</b>	OUT
<b>Composite</b>	MONITOR OUT, VCR/DVR OUT

## Audio Inputs

<b>Digital</b>	Optical: 2 Coaxial: 1
<b>Analog</b>	BD/DVD, VCR/DVR, CBL/SAT, GAME, TV/CD, AUX

## Audio Outputs

<b>Analog</b>	VCR/DVR
<b>Speaker Outputs</b>	SP-A (L, R, C, SL, SR, SW) + SP-B (L, R)
<b>Phones</b>	1 (6.3 φ)

## Others

<b>USB</b>	1 (Front)
<b>RI</b>	1

Specifications and features are subject to change without notice.



# Memo

# Memo

# ONKYO

## ONKYO SOUND & VISION CORPORATION

2-1, Nisshin-cho, Neyagawa-shi, OSAKA 572-8540, JAPAN  
Tel: 072-831-8023 Fax: 072-831-8163  
<http://www.onkyo.com/>

## ONKYO U.S.A. CORPORATION

18 Park Way, Upper Saddle River, N.J. 07458, U.S.A.  
Tel: 800-229-1687, 201-785-2600 Fax: 201-785-2650  
<http://www.us.onkyo.com/>

## ONKYO EUROPE ELECTRONICS GmbH

Liegnitzerstrasse 6, 82194 Groeben Zell, GERMANY  
Tel: +49-8142-4401-0 Fax: +49-8142-4401-555  
<http://www.eu.onkyo.com/>

## ONKYO EUROPE ELECTRONICS GmbH (UK BRANCH)

The Coach House 81A High Street, Marlow, Buckinghamshire, SL7 1AB, UK  
Tel: +44-(0)1628-473-350 Fax: +44-(0)1628-401-700

## ONKYO CHINA LIMITED

Unit 1033, 10/F, Star House, No 3, Salisbury Road, Tsim Sha Tsui Kowloon, Hong Kong.  
Tel: 852-2429-3118 Fax: 852-2428-9039  
<http://www.onkyochina.com/>

## ONKYO CHINA PRC

1301, 555 Tower, No.555 West NanJin Road, Jin an, Shanghai,  
China 200041, Tel: 86-21-52131366 Fax: 86-21-52130396  
<http://www.cn.onkyo.com/>

SN 29401049

(C) Copyright 2012 ONKYO SOUND & VISION CORPORATION Japan. All rights reserved.

Y1112-1



\* 2 9 4 0 1 0 4 9 \*

### Supplied Accessories

Make sure you have the following accessories.

#### Front speaker (SKF-391)

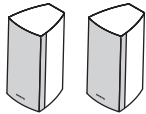

Front speakers

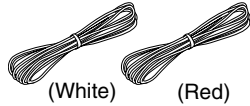

Speaker cables 10 ft. (3.0 m)

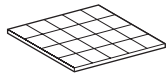

20 rubber stoppers\*1  
(For Front/Center/  
Surround speakers)

\*1 Configuration of the rubber stoppers may be different from the figure, such as being 2 sheets instead of 1 sheet, but the total number will be same.

#### Center speaker (SKC-391/SKC-391C)

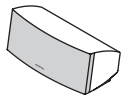

Center speaker

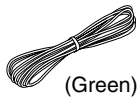

Speaker cable 10 ft. (3.0 m)

SKC-391 (North American and Brazilian)  
SKC-391C (Asian)

#### Surround speaker (SKR-391)

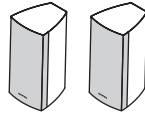

Surround speakers

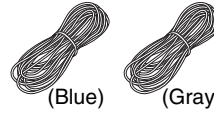

Speaker cables 26 ft. (8.0 m)

#### Subwoofer (SKW-391)

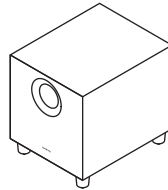

Subwoofer

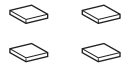

4 floor pads

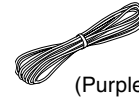

Speaker cable 10 ft. (3.0 m)

### Part Names

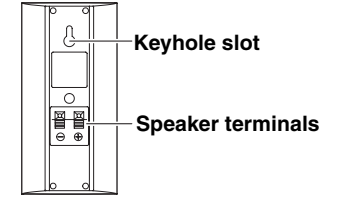

SKF-391/SKR-391

Speaker terminals

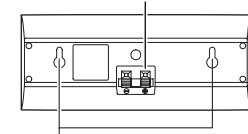

SKC-391/  
SKC-391C

Keyhole slots

#### Caution

- The front grilles are not designed to be removed so do not attempt to remove them forcibly, as this will damage them.

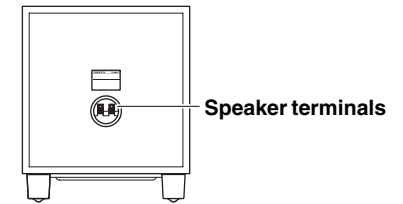

SKW-391

## Before Using the Home Theater Speaker Package

### Using the Rubber Stoppers for a More Stable Platform

We recommend using the supplied rubber stoppers to achieve the best possible sound from your speakers. The rubber stoppers prevent the speakers from moving, providing a more stable platform.

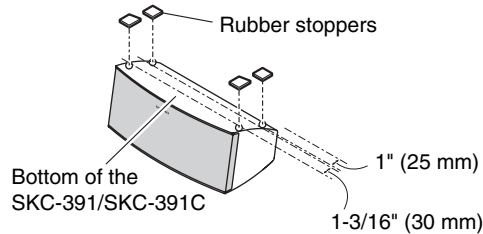
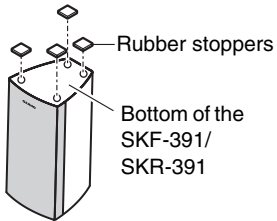

### Using the Floor Pads for Subwoofer

If the subwoofer is placed on a hard floor (wood, vinyl, tile, etc.) and playback is very loud, the subwoofer's feet may damage the flooring. To prevent this, place the supplied pads underneath the subwoofer's feet. The pads also provide a stable base for the subwoofer.

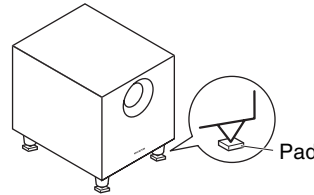

### Wall Mounting

To mount the front/surround speakers vertically, use the keyhole slot shown to hang each speaker on a screw that's securely screwed into the wall.

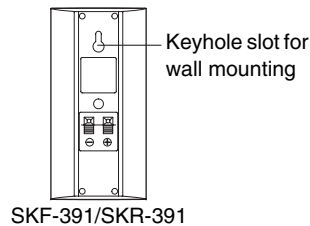

To mount the center speaker horizontally, use the two keyhole slots shown to hang the speaker on two screws that are securely screwed into the wall.

Keyhole slots for wall mounting

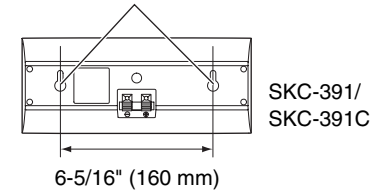

#### Tip

- If the center speaker is tilted, loosen the screw on the declined side to move upward so that the speaker could be adjusted vertically.

#### Caution

- A mounting screw's ability to support a speaker depends on how well it's anchored to the wall. If you have hollow walls, screw each mounting screw into a stud. If there are no studs, or the walls are solid, use suitable wall anchors. Use screws with a head diameter of 5/16" (9 mm) or less and a shank diameter of 1/8" (4 mm) or less. With hollow walls, use a cable/pipe detector to check for any power cables or water pipes before making any holes.
- Leave a gap of between 3/16" (5 mm) and 7/16" (10 mm) between the wall and the base of the screw head, as shown (We recommend that you consult a home installation professional).

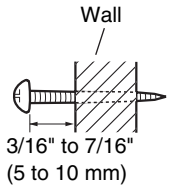

## Enjoying Home Theater

The Home Theater means that you can enjoy surround sound with a real sense of movement in your own home — just like being in a movie theater or concert hall.

### ① Front left and right speakers (SKF-391)

They should be positioned facing the listener at about ear level, and equally spaced from the TV. Angle them inward slightly so as to create a triangle, with the listener at the apex.

### ② Center speaker (SKC-391/SKC-391C)

Position it close to your TV (preferably on top) facing forward at about ear level, or at the same height as the front left and right speakers.

### ③ Surround left and right speakers (SKR-391)

Position them at the sides of the listener, or slightly behind, about 2 to 3 feet (60 to 100 cm) above ear level. Ideally they should be equally spaced from the listener.

### ④ Subwoofer (SKW-391)

The subwoofer handles the bass sounds of the LFE (Low-Frequency Effects) channel and bass from the satellite speakers when a crossover is specified. The volume and quality of the bass output from your subwoofer will depend on its position, the shape of your listening room, and your listening position. In general, a good bass sound can be obtained by installing the subwoofer in a front corner, or at one-third the way along the front wall, as shown.

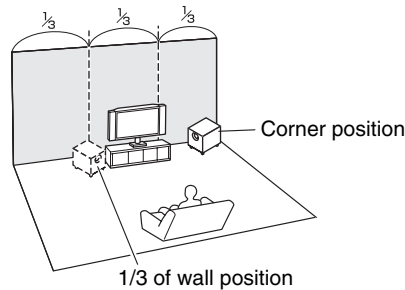
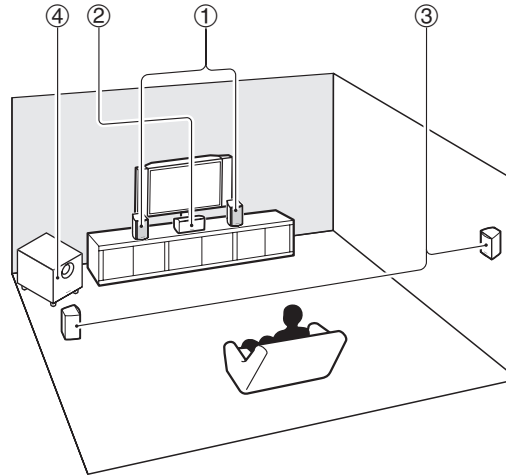

## Connecting the Speakers

### Speaker Connection Precautions

Read the following before connecting your speakers:

- Turn off your receiver before making any connections.
- Pay close attention to speaker wiring polarity. Connect positive (+) terminals to only positive (+) terminals, and negative (-) terminals to only negative (-) terminals. If the speakers are wired incorrectly, the sound will be out of phase and will sound unnatural.
- Be careful not to short the positive and negative wires. Doing so may damage your amp.

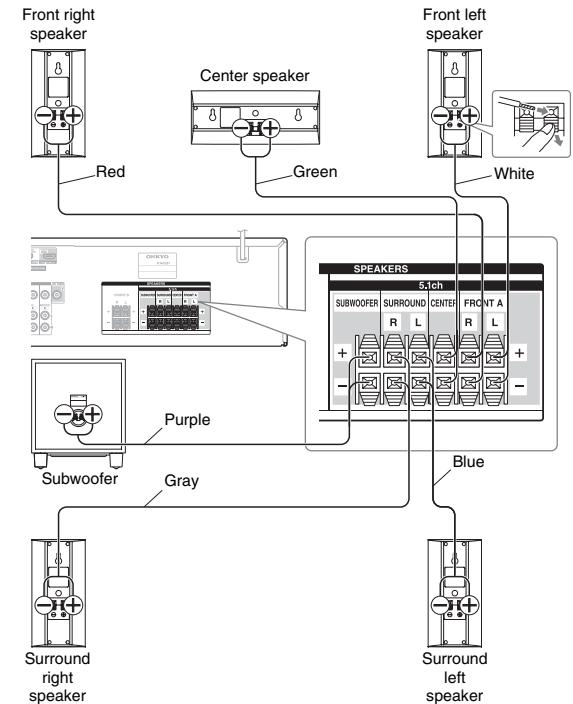

## Specifications

### ■ Passive Subwoofer (SKW-391)

<b>Type</b>	Bass-reflex type Passive subwoofer
<b>Impedance</b>	6 Ω
<b>Maximum input power</b>	130 W
<b>Sensitivity</b>	83 dB/W/m
<b>Frequency response</b>	30 Hz to 150 Hz
<b>Cabinet capacity</b>	0.88 cubic feet (25 L)
<b>Dimensions (W × H × D)</b>	11-5/8" × 13-9/16" × 14-1/2" (295 mm × 345 mm × 368 mm) (incl. projection)
<b>Weight</b>	14.1 lbs. (6.4 kg)
<b>Drivers unit</b>	8" (20 cm) Cone × 1
<b>Terminal</b>	Spring type color coded
<b>Other</b>	Non-magnetic shielding

### ■ Front Speakers (SKF-391)

<b>Type</b>	Full Range Bass-reflex
<b>Impedance</b>	6 Ω
<b>Maximum input power</b>	120 W
<b>Sensitivity</b>	80 dB/W/m
<b>Frequency response</b>	80 Hz to 20 kHz
<b>Cabinet capacity</b>	0.039 cubic feet (1.1 L)
<b>Dimensions (W × H × D)</b>	4" × 7-7/8" × 4-1/2" (101 mm × 200 mm × 114 mm) (incl. grille and projection)
<b>Weight</b>	1.5 lbs (0.7 kg)
<b>Drivers unit</b>	3-1/4" (8 cm) Cone × 1
<b>Terminal</b>	Spring type color coded
<b>Keyhole slot</b>	Available
<b>Grille</b>	Fixed
<b>Other</b>	Non-magnetic shielding

### ■ Center Speaker

#### SKC-391 (North American and Brazilian)

<b>Type</b>	Full Range Bass-reflex
<b>Impedance</b>	6 Ω
<b>Maximum input power</b>	120 W
<b>Sensitivity</b>	80 dB/W/m
<b>Frequency response</b>	80 Hz to 20 kHz
<b>Cabinet capacity</b>	0.064 cubic feet (1.8 L)
<b>Dimensions (W × H × D)</b>	9-7/16" × 4" × 4-3/4" (240 mm × 102 mm × 121 mm) (incl. grille and projection)
<b>Weight</b>	1.8 lbs (0.8 kg)
<b>Drivers unit</b>	3-1/4" (8 cm) Cone × 1
<b>Terminal</b>	Spring type color coded
<b>Keyhole slot</b>	Available
<b>Grille</b>	Fixed
<b>Other</b>	Non-magnetic shielding

#### SKC-391C (Asian)

<b>Type</b>	Full Range Closed Box
<b>Impedance</b>	6 Ω
<b>Maximum input power</b>	120 W
<b>Sensitivity</b>	84.5 dB/W/m
<b>Frequency response</b>	80 Hz to 20 kHz
<b>Cabinet capacity</b>	0.064 cubic feet (1.8 L)
<b>Dimensions (W × H × D)</b>	9-7/16" × 4" × 4-3/4" (240 mm × 102 mm × 121 mm) (incl. grille and projection)
<b>Weight</b>	2.9 lbs (1.3 kg)
<b>Drivers unit</b>	3-1/4" (8 cm) Cone × 2
<b>Terminal</b>	Spring type color coded
<b>Keyhole slot</b>	Available
<b>Grille</b>	Fixed
<b>Other</b>	Magnetic shielding

### ■ Surround Speakers (SKR-391)

<b>Type</b>	Full Range Bass-reflex
<b>Impedance</b>	6 Ω
<b>Maximum input power</b>	120 W
<b>Sensitivity</b>	80 dB/W/m
<b>Frequency response</b>	80 Hz to 20 kHz
<b>Cabinet capacity</b>	0.039 cubic feet (1.1 L)
<b>Dimensions (W × H × D)</b>	4" × 7-7/8" × 4-1/2" (101 mm × 200 mm × 114 mm) (incl. grille and projection)
<b>Weight</b>	1.5 lbs. (0.7 kg)
<b>Drivers unit</b>	3-1/4" (8 cm) Cone × 1
<b>Terminal</b>	Spring type color coded
<b>Keyhole slot</b>	Available
<b>Grille</b>	Fixed
<b>Other</b>	Non-magnetic shielding

Specifications and appearance are subject to change without prior notice.

#### Note

#### For non-magnetic shielded speakers:

Try moving the speakers away from your TV or monitor. If discoloration should occur, turn off your TV or monitor, wait 15 to 30 minutes, and then turn it back on again. This normally activates the degaussing function, which neutralizes the magnetic field, thereby removing any discoloration effects.





### Accessoires fournis

Assurez-vous que le carton contient bien les accessoires suivants.

#### Enceinte avant (SKF-391)

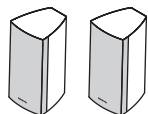

Enceintes avant

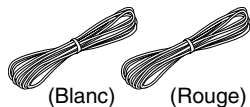

Câbles d'enceinte 3,0 m  
(Blanc) (Rouge)

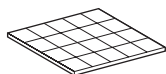

20 bouchons de caoutchouc\*1  
(Pour enceintes avant/  
centrale/surround)

\*1 La configuration des bouchons de caoutchouc peut être différente de la figure, en comportant par exemple 2 feuilles au lieu d'une, mais leur nombre total est identique.

#### Enceinte centrale (SKC-391/SKC-391C)

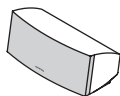

Enceinte centrale

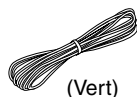

Câble d'enceinte 3,0 m  
(Vert)

SKC-391 (Nord-américains et brésiliens)

SKC-391C (Asie)

#### Enceinte surround (SKR-391)

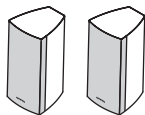

Enceintes surround

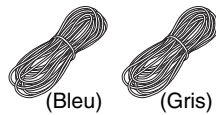

Câbles d'enceinte 8,0 m  
(Bleu) (Gris)

#### Subwoofer (SKW-391)

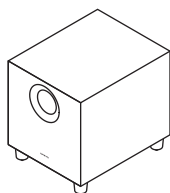

Subwoofer

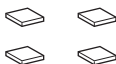

4 tampons de protection



Câble d'enceinte 3,0 m  
(violet)

### Noms des pièces

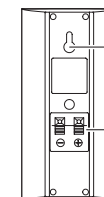

Encoche en trou de serrure

Bornes d'enceinte

SKF-391/SKR-391

Bornes d'enceinte

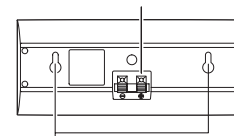

SKC-391/  
SKC-391C

Encoches en trou de serrure

#### Mise en garde

- Les grilles avant ne sont pas faites pour être retirées, aussi n'essayez pas de les retirer de force, car ceci les endommagera.

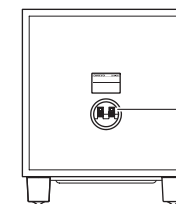

Bornes d'enceinte

SKW-391

## Avant d'utiliser l'Ensemble d'enceintes du Home cinéma

### Utilisation des bouchons en caoutchouc pour une meilleure stabilité

Nous vous recommandons d'utiliser les bouchons en caoutchouc fournis pour obtenir le meilleur son possible de vos enceintes. Les bouchons en caoutchouc empêchent les enceintes de bouger, en procurant une meilleure stabilité.

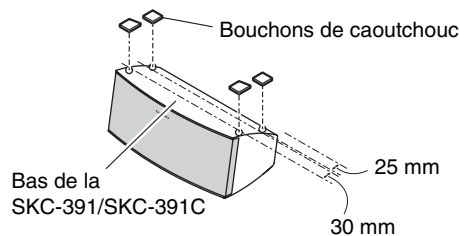
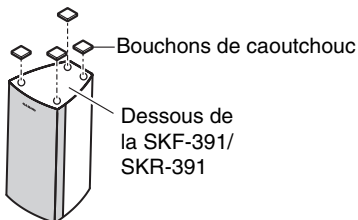

### Utilisation des tampons de protection pour le subwoofer

Si le subwoofer est placé sur un sol dur (bois, vinyle, carrelage, etc.) et si le niveau sonore de la lecture est élevé, les pieds du subwoofer peuvent endommager le sol. Pour empêcher ceci, placez les tampons fournis sous les pieds du subwoofer. Les tampons fournissent également une base stable au subwoofer.

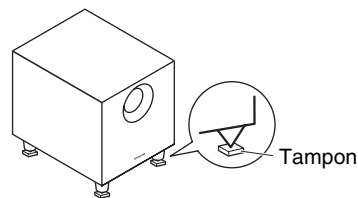

### Fixation au mur

Pour fixer les enceintes avant/surround de façon verticale, utilisez l'encoche en trou de serrure pour accrocher chaque enceinte sur une vis bien vissée au mur.

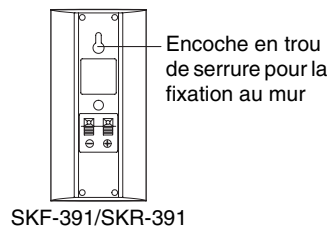

Pour fixer l'enceinte centrale de façon horizontale, utilisez les deux encoches en trou de serrure indiquées pour accrocher l'enceinte à deux vis bien fixées au mur.

Encoche en trou de serrure pour la fixation au mur

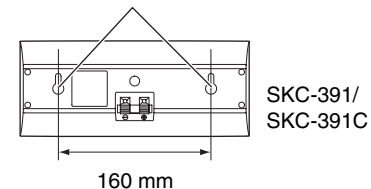

### Conseil

- Si l'enceinte centrale est inclinée, dévissez la vis du côté incliné pour régler la position verticale de l'enceinte et la redresser.

### Mise en garde

- La capacité de la vis de fixation permettant de supporter une enceinte dépend de la façon dont elle est fixée au mur. Si vos murs sont creux, vissez chaque vis de fixation dans un montant. S'il n'y a aucun montant, ou si les murs sont pleins, utilisez des fixations murales adéquates. Utilisez des vis dont la tête a un diamètre de 9 mm maximum et un diamètre de la partie lisse de la tige de 4 mm maximum. Pour les murs creux, utilisez un détecteur de câbles/canalisation pour vérifier la présence éventuelle de câbles d'alimentation ou de canalisations d'eau avant d'effectuer des percements.
- Laissez un espace de 5 à 10 mm entre le mur et la base de la tête de la vis, comme indiqué (Nous vous recommandons de consulter un professionnel de l'installation domestique).

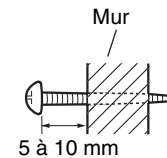

## Vivez une expérience cinématographique à domicile

Grâce au Home Cinema, vous pouvez profiter d'un son surround très réaliste à votre domicile — comme si vous étiez dans une salle de cinéma ou de concert.

### ① Enceintes avant gauche et droite (SKF-391)

Elles doivent être positionnées face à l'auditeur, à la hauteur des oreilles et être situées à distance égale du téléviseur. Orientez-les légèrement vers l'intérieur de manière à créer un triangle avec l'auditeur.

### ② Enceinte centrale (SKC-391/SKC-391C)

Positionnez-la à proximité de votre téléviseur (de préférence dessus), face à vous, à la hauteur des oreilles ou à la même hauteur que les enceintes avant gauche et droite.

### ③ Enceintes surround gauche et droite (SKR-391)

Placez-les sur les côtés de l'auditeur, ou légèrement derrière lui, 60 à 100 cm environ au-dessus du niveau des oreilles. Idéalement, elles doivent se situer à égale distance de l'auditeur.

### ④ Subwoofer (SKW-391)

Le subwoofer gère les graves du canal chargé des effets LFE (effets basse fréquence) et les graves des enceintes satellites lorsqu'un crossover est spécifié. Le volume et la qualité des sons graves émis par le subwoofer dépendent de sa position, de la forme de la pièce où le système est installé et de votre position d'écoute. En général, il est possible d'obtenir un bon son grave en installant le subwoofer dans un coin situé devant l'auditeur ou à environ un tiers de la largeur du mur (cf. illustration).

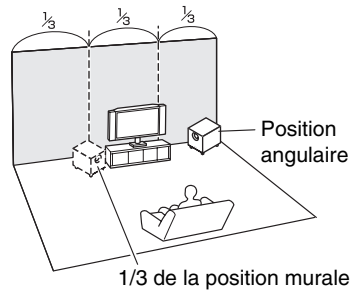
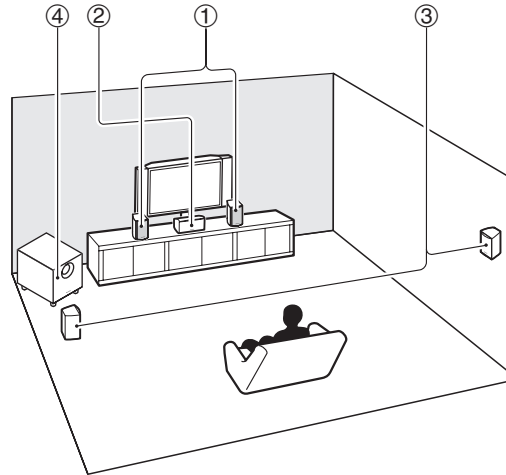

## Branchement des enceintes

### Précautions concernant le branchement des enceintes

Lisez ce qui suit avant de brancher vos enceintes :

- Éteignez votre récepteur avant d'effectuer les branchements.
- Faites très attention à respecter la polarité des câbles de vos enceintes. Ne branchez les bornes positives (+) que sur les bornes positives (+) et les bornes négatives (-) que sur les bornes négatives (-). Si les enceintes sont branchées de façon incorrecte, le son sera déphasé et ne semblera pas naturel.
- Veillez à ne pas mettre ne pas mettre les fils positifs et négatifs en court-circuit. Vous risqueriez d'endommager votre amplificateur.

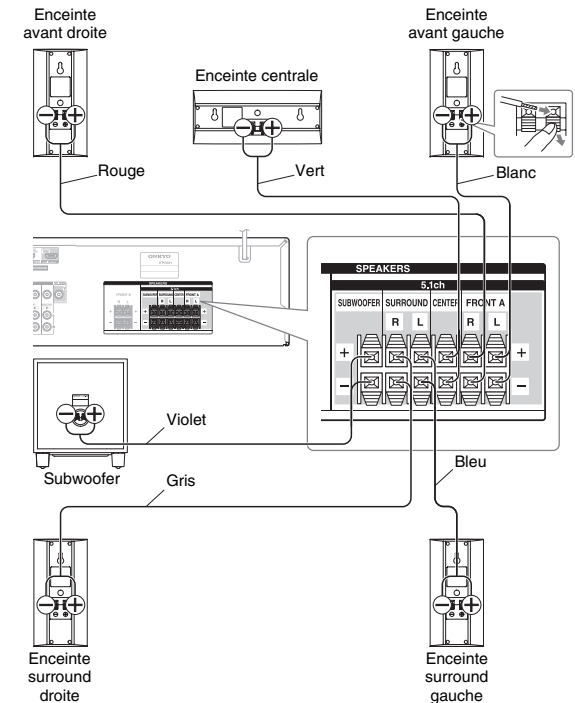

## Caractéristiques techniques

### ■ Subwoofer passif (SKW-391)

Type	Subwoofer passif de type bass-reflex
Impédance	6 Ω
Puissance d'entrée maximale	130 W
Sensibilité	83 dB/W/m
Distorsion de fréquence	30 Hz à 150 Hz
Capacité du coffrage	0,88 pieds cubiques (25 L)
Dimensions (L × H × P)	11-5/8" × 13-9/16" × 14-1/2" (295 mm × 345 mm × 368 mm) (y compris la projection)
Poids	14,1 lbs. (6,4 kg)
Amplificateur	Cône de 8" (20 cm) × 1
Borne	À ressort et à code couleur
Autre	Protection non-magnétique

### ■ Enceintes avant (SKF-391)

Type	Bass-reflex à large bande
Impédance	6 Ω
Puissance d'entrée maximale	120 W
Sensibilité	80 dB/W/m
Distorsion de fréquence	80 Hz à 20 kHz
Capacité du coffrage	0,039 pieds cubiques (1,1 L)
Dimensions (L × H × P)	4" × 7-7/8" × 4-1/2" (101 mm × 200 mm × 114 mm) (y compris la grille et la projection)
Poids	1,5 lbs (0,7 kg)
Amplificateur	Cône de 3-1/4" (8 cm) × 1
Borne	À ressort et à code couleur
Encoche en trou de serrure	Disponible
Grille	Fixe
Autre	Protection non-magnétique

### ■ Enceinte centrale

#### SKC-391 (Nord-américains et brésiliens)

Type	Bass-reflex à large bande
Impédance	6 Ω
Puissance d'entrée maximale	120 W
Sensibilité	80 dB/W/m
Distorsion de fréquence	80 Hz à 20 kHz
Capacité du coffrage	0,064 pieds cubiques (1,8 L)
Dimensions (L × H × P)	9-7/16" × 4" × 4-3/4" (240 mm × 102 mm × 121 mm) (y compris la grille et la projection)
Poids	1,8 lbs (0,8 kg)
Amplificateur	Cône de 3-1/4" (8 cm) × 1
Borne	À ressort et à code couleur
Encoche en trou de serrure	Disponible
Grille	Fixe
Autre	Protection non-magnétique

#### SKC-391C (Asie)

Type	Large Bande à Coffrage Fermé
Impédance	6 Ω
Puissance d'entrée maximale	120 W
Sensibilité	84,5 dB/W/m
Distorsion de fréquence	80 Hz à 20 kHz
Capacité du coffrage	0,064 pieds cubiques (1,8 L)
Dimensions (L × H × P)	9-7/16" × 4" × 4-3/4" (240 mm × 102 mm × 121 mm) (y compris la grille et la projection)
Poids	2,9 lbs (1,3 kg)
Amplificateur	Cône de 3-1/4" (8 cm) × 2
Borne	À ressort et à code couleur
Encoche en trou de serrure	Disponible
Grille	Fixe
Autre	Protection magnétique

### ■ Enceintes surround (SKR-391)

Type	Bass-reflex à large bande
Impédance	6 Ω
Puissance d'entrée maximale	120 W
Sensibilité	80 dB/W/m
Distorsion de fréquence	80 Hz à 20 kHz
Capacité du coffrage	0,039 pieds cubiques (1,1 L)
Dimensions (L × H × P)	4" × 7-7/8" × 4-1/2" (101 mm × 200 mm × 114 mm) (y compris la grille et la projection)
Poids	1,5 lbs. (0,7 kg)
Amplificateur	Cône de 3-1/4" (8 cm) × 1
Borne	À ressort et à code couleur
Encoche en trou de serrure	Disponible
Grille	Fixe
Autre	Protection non-magnétique

Les caractéristiques techniques et l'apparence de cet appareil sont susceptibles d'être modifiées sans préavis.

#### Remarque

#### Pour enceintes blindées non magnétiques :

Essayez d'éloigner les enceintes de votre téléviseur ou de votre moniteur. Si une décoloration se produit, éteignez votre téléviseur ou votre moniteur, attendez 15 à 30 minutes, puis rallumez le téléviseur ou le moniteur. Ceci active normalement la fonction de démagnétisation, qui neutralise le champ magnétique, supprimant ainsi les effets de décoloration.

