

System Board D2542 for RX100 S5

Technical Manual

Comments... Suggestions... Corrections...

The User Documentation Department would like to know your opinion of this manual. Your feedback helps us optimize our documentation to suit your individual needs.

Feel free to send us your comments by e-mail to manuals@fujitsu-siemens.com.

Certified documentation according to DIN EN ISO 9001:2000

To ensure a consistently high quality standard and user-friendliness, this documentation was created to meet the regulations of a quality management system which complies with the requirements of the standard DIN EN ISO 9001:2000.

cognitas. Gesellschaft für Technik-Dokumentation mbH
www.cognitas.de

Copyright and Trademarks

Copyright © 2007 Fujitsu Siemens Computers GmbH.

All rights reserved.

Delivery subject to availability; right of technical modifications reserved.

All hardware and software names used are trademarks of their respective manufacturers.

Contents

1	Introduction	5
2	Important notes	7
2.1	Notes on safety	7
2.2	CE Certificate	10
2.3	Environmental Protection	11
3	Features	13
3.1	Overview	13
3.2	Main memory	17
3.3	PCI bus	18
3.4	Screen resolution	19
3.5	Temperature / system monitoring	19
3.6	LEDs	21
3.7	Interfaces and connectors	23
3.7.1	External ports	24
3.8	Settings with jumpers	26
4	Replacing the lithium battery	27
	Abbreviations	29

1 Introduction

This technical manual describes the system board D2542, which is equipped with one Intel® processor.

Further information about drivers is provided in the readme files on the hard disk, on the supplied “ServerStart“ or “Update“ CDs.

You will find further information in the BIOS description.

Notational conventions

The meanings of the symbols and fonts used in this manual are as follows:



<i>italics</i>	indicates commands, menu items, file and path names or software programs
fixed font	indicate system output on the monitor
semi-bold fixed font	indicates values to be entered through the keyboard
Key symbol	indicates keys according to their representation on the keyboard If capital letters are to be entered explicitly, then the Shift key is shown, e.g. SHIFT - A for A. If two keys need to be pressed at the same time, then this is shown by placing a hyphen between the two key symbols.
“quotation marks”	indicates names and terms that are being emphasized.
▶	indicates an operation that to be performed
 CAUTION!	indicates warnings, which, if ignored, will endanger your health, destroy the system or lead to the loss of data.
	indicates additional information, notes and tips

Table 1: Notational conventions

2 Important notes

In this chapter you will find essential information regarding safety when working with your server.



CAUTION!

With the system board installed you must open the system to access the system board. How to access the system board of your system is described in the appropriate service supplement.

When handling the system board, refer to the specific notes on safety in the operating manual and/or service supplement for the respective server.

2.1 Notes on safety



CAUTION!

- The actions described in these instructions should only be performed by authorized, qualified personnel. Equipment repairs should only be performed by qualified staff. Any failure to observe the guidelines in this manual, and any unauthorized openings and improper repairs could expose the user to risks (electric shock, fire hazards) and could also damage the equipment. Please note that any unauthorized openings of the device will result in the invalidation of the warranty and exclusion from all liability.
- Transport the device only in the antistatic original packaging or in packaging that protects it from knocks and jolts.
- Only install expansions that are allowed for the system board. If you install other expansions, you may damage the requirements and rules governing safety and electromagnetic compatibility or your system. Information on which system expansions are suitable can be obtained from the customer service centre or your sales outlet.
- The warranty expires if the device is damaged during the installation or replacement of system expansions.



- Components can become very hot during operation. Ensure you do not touch components when making extensions to the system board. There is a danger of burns!.
- Transmission lines to peripheral devices must be adequately shielded.
- To the LAN wiring the requirements apply in accordance with the standards EN 50173 and EN 50174-1/2. As minimum requirement the use of a protected LAN line of category 5 for 10/100 MBps Ethernet, and/or of category 5e for Gigabit Ethernet is considered. The requirements of the specification ISO/IEC 11801 are to be considered.
- Never connect or disconnect data transmission lines during a storm (lightning hazard).

Batteries



CAUTION!

- Incorrect replacement of lithium battery may lead to a risk of explosion. The batteries may only be replaced with identical batteries or with a type recommended by the manufacturer.

It is essential to observe the instructions in [chapter “Replacing the lithium battery”](#).

Modules with electrostatic-sensitive components

Systems and components that might be damaged by electrostatic discharge (ESD) are marked with the following label:

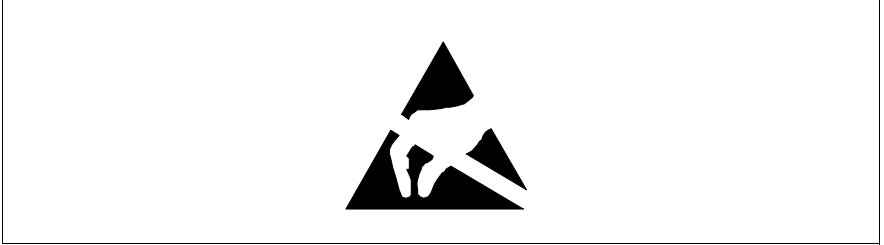



Figure 1: ESD label

When you handle components fitted with ESDs, you must observe the following points under all circumstances:

- You must always discharge yourself of static charges (e.g. by touching a grounded object) before working.
- The equipment and tools you use must be free of static charges.
- Remove the power plug from the power socket before inserting or removing boards containing ESDs.
- Always hold boards with ESDs by their edges.
- Never touch pins or conductors on boards fitted with ESDs.
- Use a grounding cable designed for this purpose to connect yourself to the system unit as you install/deinstall the board.
- Place all components on a static-safe base.

 You will find a detailed description for handling ESD components in the relevant European or international standards (EN 61340-5-1, ANSI/ESD S20.20).

Notes about boards

- During installation/deinstallation of the system board, observe the specific instructions described in the service manual for the server.
- Remove the plug from the mains outlet so that system and system board are totally disconnected from the mains voltage.
- To prevent damage to the system board, the components and conductors on it, please take great care when you insert or remove boards. Take great care to ensure that extension boards are slotted in straight, without damaging components or conductors on the system board, or any other components, for example EMI spring contacts
- Be careful with the locking mechanisms (catches, centring pins etc.) when you replace the system board or components on it, for example memory modules or processors.
- Never use sharp objects (screwdrivers) for leverage.

2.2 CE Certificate



The shipped version of this board complies with the requirements of the EEC directive 2004/108/EC "Electromagnetic compatibility".

Compliance was tested in a typical PRIMERGY configuration.

2.3 Environmental Protection

Environmentally friendly product design and development

This product has been designed in accordance with standards for "environmentally friendly product design and development". This means that the designers have taken into account important criteria such as durability, selection of materials and coding, emissions, packaging, the ease with which the product can be dismantled and the extent to which it can be recycled.

This saves resources and thus reduces the harm done to the environment.

Notes on saving energy

Devices that do not have to be on permanently should not be switched on until they need to be used and should be switched off during long breaks and on completion of work.

Notes on packaging

Please do not throw away the packaging. We recommend that you do not throw away the original packaging in case you need it later for transporting.

Notes on dealing with consumables

Please dispose batteries in accordance with local government regulations.

Do not throw batteries and accumulators into the household waste. They must be disposed of in accordance with local regulations concerning special waste.

All batteries containing pollutants are marked with a symbol (a crossed-out rubbish bin on wheels). In addition, the marking is provided with the chemical symbol of the heavy metal decisive for the classification as a pollutant:

Cd Cadmium

Hg Mercury

Pb Lead

Notes on labeling plastic housing parts

Please avoid attaching your own labels to plastic housing parts wherever possible, since this makes it difficult to recycle them.

Returning, recycling and disposal



The device may not be disposed of with household rubbish. This appliance is labelled in accordance with European Directive 2002/96/EC concerning used electrical and electronic appliances (waste electrical and electronic equipment - WEEE).

The guideline determines the framework for the return and recycling of used appliances as applicable throughout the EU. To return your used device, please use the return and collection systems available to you. You will find further information on this at www.fujitsu-siemens.com/recycling.

For details on returning and reuse of devices and consumables within Europe, refer to the "Returning used devices" manual, or contact your Fujitsu Siemens Computers branch office/subsidiary or our recycling centre in Paderborn:

Fujitsu Siemens Computers
Recycling Center
D-33106 Paderborn

Tel. +49 5251 8 18010

Fax +49 5251 8 18015

3 Features

3.1 Overview

There are two versions of the system board D2542 with the part numbers S26361-D2542-A10 (SAS version) and S26361-D2542-B10 (SATA version). The two versions differ in the chipset and connectors assembling.

Processors

- One Intel® Xeon processor, Quad Core, Dual Core or Single Core or a Conroe-L Single processor with 800/1066/1333 MHz Front Side Bus, socket 775
- second level cache depending on the processor

Main memory

- Up to 4 slots for main memory DDR II 800 (PC2-6400) SDRAM unbuffered
- Maximum 16 Gbyte of memory
- Memory modules for 512 MB, 1 GB, 2 GB and 4 GB
- Supports dual-channel DDR2 interface with interleaved mode.
- Supports ECC (Error Correction Code)

Chips on the system board

- Intel® chipset:
 - Bigby-P
 - Southbridge: Intel® ICH9-R (SATA)
 - Southbridge: Intel® ICH9 (SAS)
 - SAS-Controller LSI 1064E (only SAS version).
- On optional riser card:
 - 2 x PCI express x8
- Super I/O SMSC 5027
- Dual Gigabit LAN controller: Broadcom 5715 C
- iRMC onboard Server Management and graphic controller
- BMC Kronos II iRMC

External connectors

- Front side (front panel):
2x USB 2.0 port
- Rear side (I/O shield):
2x USB 2.0 ports
1x VGA port (15 pin)
1x keyboard port
1x mouse port
1x RS-232-C interface (serial 9 pin)
2x RJ45 LAN ports (onboard LAN)
1x RJ45 service LAN port

Internal connectors

- SATA System Board:
3 serial SATA
SAS/SATA BP LED
Front panel
NMI
Reset
- SAS System Board:
1 serial SATA
1 SAS
SAS/SATA BP LED
Front panel
NMI
Reset

BIOS features

- Phoenix system BIOS
- Power on self-test
- CMOS setup parameter
- Shadow RAM BIOS
- Shadow video BIOS
- IPMI V2.0 support
- DMI function support
- System security: Power-on Password and Setup Password
- Boot possible from:
 - CD/DVD-ROM
 - Hard disk
 - LAN
 - USB

Environmental protection

Battery in holder for recycling

Form factor

- 260 mm x 305 mm

CSS (Customer Self Service)

This system board supports the CSS functionality. You will find a description of CSS functionality in the operating manual of your server.

TPM (Option)

The system board is equipped with a TPM (Trusted Platform Module) by the manufacturer. This module enables programs from third party manufacturers to store key information (e.g. drive encryption using Windows Bitlocker Drive Encryption).

The TPM is activated via the BIOS system (for more information, refer to the Fujitsu Siemens Computers BIOS manual).



CAUTION!

- When using the TPM, note the program descriptions provided by the third party manufacturers.
- You must also create a backup of the TPM content. To do this, follow the third party manufacturer's instructions. Without this backup, if the TPM or the system board is faulty you will not be able to access your data.
- If a failure occurs, please inform your service about the TPM activation before it takes any action, and be prepared to provide them with your backup copies of the TPM content.

3.2 Main memory

The four slots for the main memory are suitable for unbuffered DDR II 800 (PC2-6400) SDRAM memory modules. The organization in two memory banks, 1 and 2, permits rapid memory access with two-way interleaving.

i You will find the descriptions how to install memory modules in the Option Guide of your server.

Module population

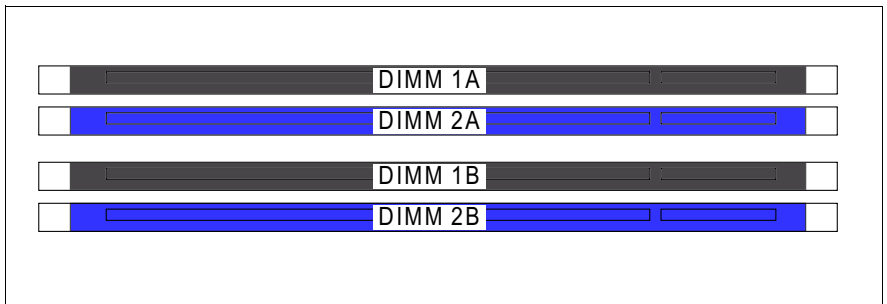

Figure 2: Assembly of the main memory with memory banks and memory modules

Population of the memory

Basic	DIMM1A	DIMM2A	DIMM1B	DIMM2B
1 x memory module	x			

Table 2: Basic configuration with 1 memory module

Basic	DIMM1A	DIMM2A	DIMM1B	DIMM2B
1 x memory module	x*		x	
2 x memory modules	x*	x	x	
3 x memory modules	x*	x	x	x

Table 3: Basic configuration with 1 memory module and 1, 2 or 3 additional memory modules

*) Already populated by basic configuration.

Basic	DIMM1A	DIMM2A	DIMM1B	DIMM2B
2 x memory modules	x		x	

Table 4: Basic configuration with 2 memory modules

Basic	DIMM1A	DIMM2A	DIMM1B	DIMM2B
2 x memory modules	x*	x	x	x

Table 5: Basic configuration with 2 memory modules and 2 additional memory modules

*) Already populated by basic configuration.

Install identical DIMMs in socket 1A and 1B and identical DIMMs in socket 2A and 2B.

3.3 PCI bus

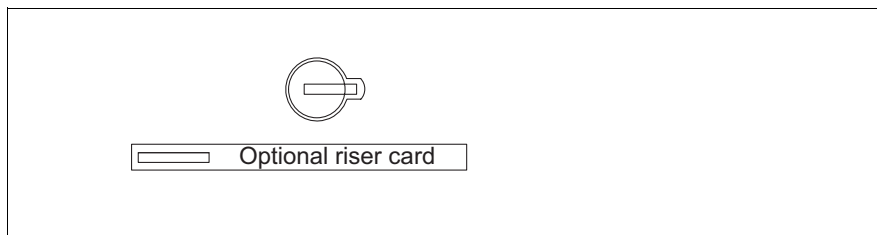

Figure 3: PCI slots

PCI slots

The following tables show an overview of the PCI slots:

PCI bus	Signal level	Slot no,	Length
PCI-E x8		1	1x low profile or standard slot, max. length 175 mm
PCI-E x8		2	1x low profile slot, max. length 170 mm

3.4 Screen resolution

Depending on the operating system used the screen resolutions in the following table refer to the screen controller on the system board. If you are using an external screen controller, you will find details of supported screen resolutions in the operating manual or technical manual supplied with the controller.

Screen resolution	Supported colors
640x480	8 bit, 16 bit, 24 bit, 32 bit
800x600	16 bit, 24 bit, 32 bit
1024x768	16 bit, 24 bit, 32 bit
1280x1024	8 bit, 16 bit

3.5 Temperature / system monitoring

Temperature and system monitoring aim to reliably protect the computer hardware against damage caused by overheating. In addition, any unnecessary noise is also prevented by reducing the fan speed, and information is provided about the system status.

The temperature and system monitoring are controlled by an onboard controller.

The following functions are supported:

Temperature monitoring

Measurement of the processor temperature, of the system board temperature, measurement of the ambient temperature by a temperature sensor.

Fan monitoring

Fans that are blocked or sticky are detected.

Fan control

The fans are regulated according to temperature.

Sensor monitoring

A fault in a temperature sensor is detected. Should this happen all fans monitored by this sensor run at maximum speed, to achieve the greatest possible protection of the hardware.

Voltage monitoring

When voltage exceeds warning level high an alert will be generated.

System Event Log (SEL)

All monitored events of the system board are recorded in the System Event Log.

3.6 LEDs

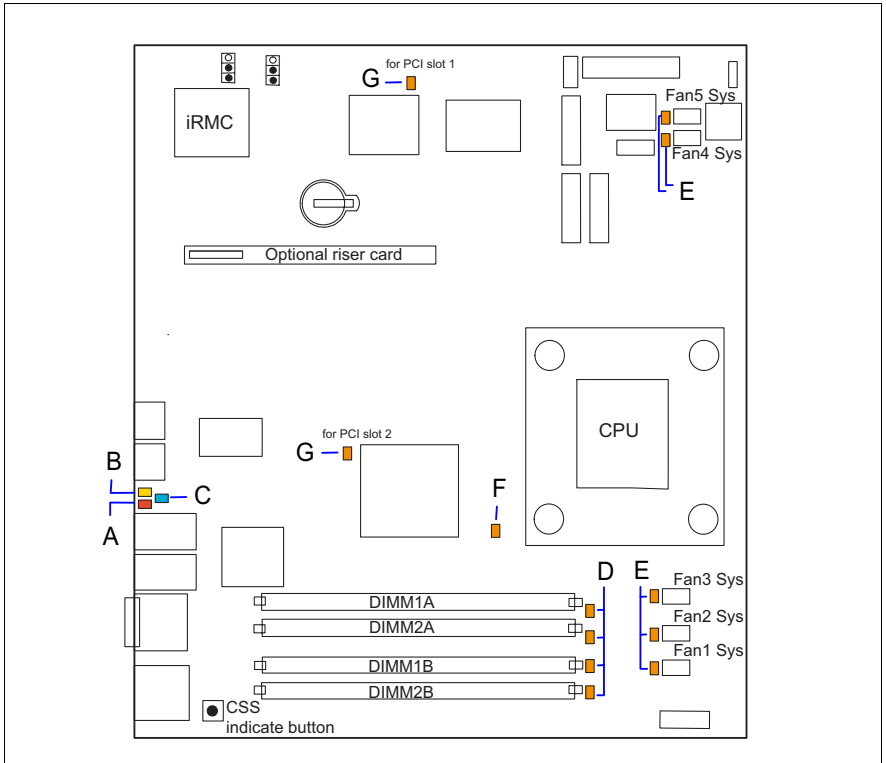

Figure 4: LEDs

LED s A, B, C, D, E and F are visible from outside on the rear of the server. LED A and LED B are different functionalities of the same LED and are glowing differently.

All the other LEDs are only visible, if the cover of the server has been opened.

The LEDs have the following meaning:

LED	Indicator	Meaning
A - GEL (Global Error LED)	red	indicates a prefailure
	red flashing	indicates a failure. Reasons for a failure may be: - overheating of one of the sensors - sensor defect - fan defect - CPU error - Software detected an error
B - CSS (Customer Self Service)	yellow	indicates a prefailure
	yellow flashing	indicates a failure
C - Identification	blue	server is identified via ServerView
D - memory	orange	memory module failure
E - system/fans	orange	fan failure
F - CPU	orange	CPU failure
G - Controller	orange	controller failure

If the server has been powered off (power-plugs must be disconnected) it is possible to indicate the faulty component by pressing the indicate CSS button.

3.7 Interfaces and connectors

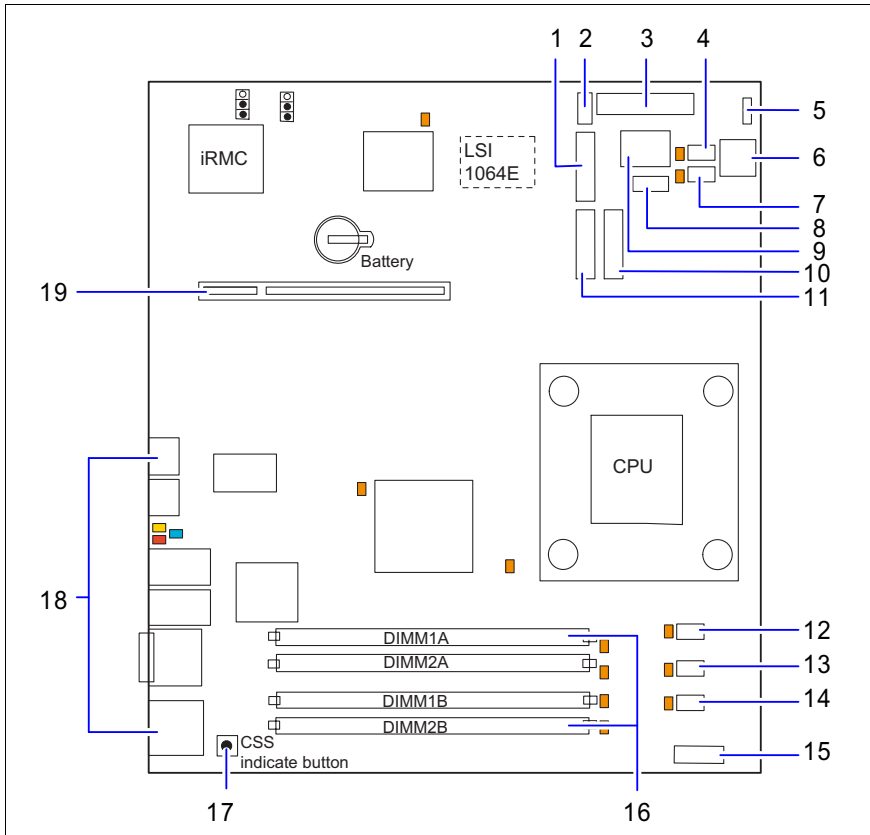

Figure 5: Schematic view of the system board D2542

- | | |
|--|---|
| 1 = SATA 2 connector (only for SATA version) | 11 = SATA 1 connector (only SATA version) |
| 2 = power supply for I ² C- | 12 = System fan 3 |
| 3 = power supply ATX | 13 = System fan 2 |
| 4 = system fan 5 | 14 = System fan 1 |
| 5 = front panel | 15 = CSS module |
| 6 = power supply ATX 12 V (CPU) | 16 = slots for memory modules |

- 7 = System fan 4
- 8 = SAS/SATA BP LED
- 9 = SAS connector (only SAS-version)
- 10 = ODD SATA 5
- 17 = CSS indicate button
- 18 = external ports
- 19 = slot for riser card

3.7.1 External ports

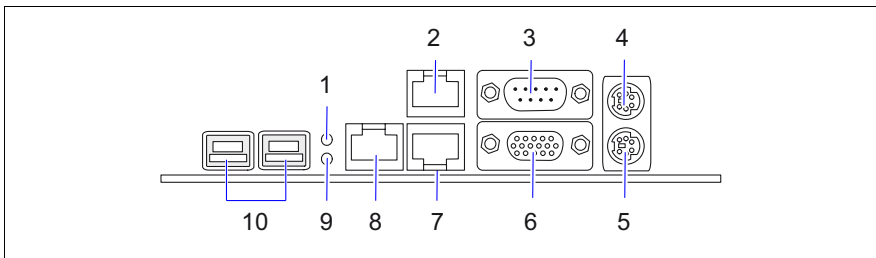

Figure 6: External ports of the system board D2542

- 1 = CSS LED (yellow)/
Global Error LED (red)
- 2 = service LAN connector
- 3 = serial connector COM1
- 4 = PS/2 mouse connector
- 5 = PS/2 keyboard connector
- 6 = VGA connector
- 7 = system LAN connector 2
- 8 = system LAN connector 1 (Server Management LAN) *)
- 9 = Identification LED (blue)
- 10 = USB connector 1 /
USB connector 2

*) The Server Management LAN is a direct communication interface between a remote system and the local iRMC. It is used for “Console Redirection” (text and graphical) and for transferring e. g. power management commands from the remote system to the iRMC via LAN.

The LAN connection (only LAN port 1) can be exclusive for management or be shared with the standard OS.

LAN connectors

This system board is populated with two Dual Gigabit LAN controllers Broadcom 5715 and a service LAN controller. The Gigabit LAN controller supports the transfer rates of 10 Mbit/s, 100 Mbit/s and 1 Gbit/s. The LAN controller supports WOL function through Magic Packet™.

It is also possible to boot a device without its own boot hard disk via LAN. Here Intel PXE is supported.

The service LAN port serves as management interface and is prepared for RemoteView.

The Gigabit LAN controller has two LAN connectors. The LAN connectors are equipped with two LEDs (light emitting diode) indicating the transfer rate and the activity.

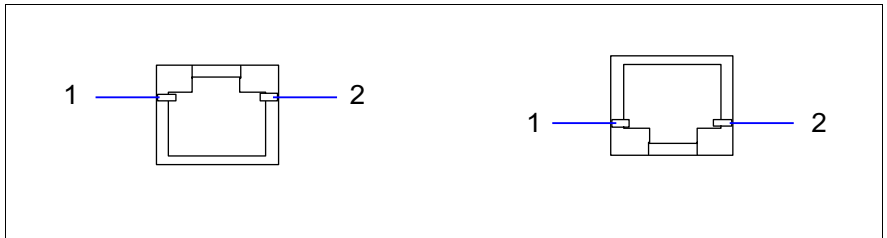

Figure 7: LAN connector

1	LAN link/activity	green	on	LAN connection
			off	no LAN connection
			flashing	LAN transfer
2	LAN transfer rate		off	transfer rate 10 Mbit/s (or no connection)
		green	on	transfer rate 100 Mbit/s
		yellow	on	transfer rate 1000 Mbit/s

3.8 Settings with jumpers

The system board is supplied with all jumpers set on the following positions.

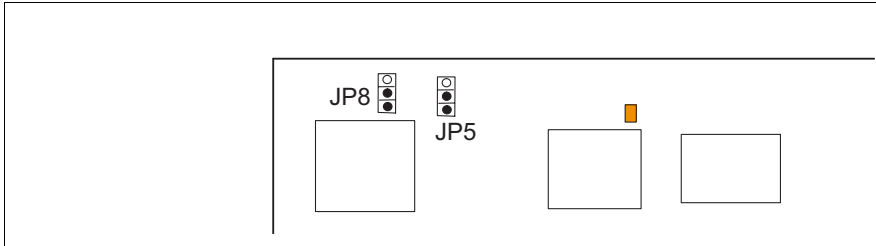

Figure 8: Jumper default settings

JP8 - Boot Block

- 1-2 Normal boot (default)
- 2-3 BIOS recovery

JP5 - Password Skip

- 1-2 Disable (default)
- 2-3 Enable

4 Replacing the lithium battery

In order to save the system information permanently, a lithium battery is installed to provide the CMOS-memory with a current. When the charge is too low or the battery is empty, a corresponding error message is provided. The lithium battery must then be replaced.



The lithium battery must be replaced with an identical battery or a battery type recommended by the manufacturer (CR2032).

Do not throw lithium batteries into the trash can. It must be disposed of in accordance with local regulations concerning special waste.

Make sure that you insert the battery the right way round. The plus pole must be on the top!

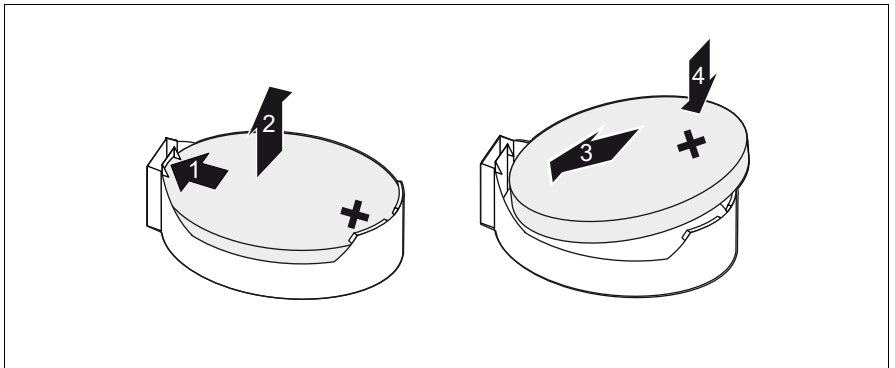

Figure 9: Replacing the lithium battery

- ▶ Press the locking spring into direction of the arrow (1), so that the lithium battery jumps out of its socket.
- ▶ Remove the battery (2).
- ▶ Insert a new lithium battery of the same type into the socket (3) and (4).

Abbreviations

The technical terms and abbreviations given below represent only a selection of the full list of common technical terms and abbreviations.

Not all technical terms and abbreviations listed here are valid for the described system board.

ACPI

Advanced Configuration and Power Interface

ASR&R

Automatic Server Recovery and Restart

ATA

Advanced Technology Attachment

BBU

Battery Backup Unit

BIOS

Basic Input Output System

BMC

Baseboard Management Controller

CMOS

Complementary Metal Oxide Semiconductor

COM

COMmunication port

CRU

Customer Replaceable Unit

CSS

Customer Self Service

CPU

Central Processing Unit

Abkürzungen

DDR

Double Data Rate

DIMM

Dual In-line Memory Module

DIP

Dual In-line Package

DMI

Desktop Management Interface

DMA

Direct Memory Access

DRAM

Dynamic Random Access Memory

ECC

Error Correction Code

EEPROM

Electrical Erasable Programmable Read Only Memory

EPROM

Erasable Programmable Read Only Memory

EMRL

Embedded RAID Logic

ESD

Electrostatic Discharge

EVRD

Enterprise Voltage Regulator Down

FBD

Fully Buffered DIMM

HDD

Hard Disk Drive

HPC	Hot-plug Controller
ICE	In Circuit Emulation
IDE	Integrated (intelligent) Drive Electronics
IME	Integrated Mirror Enhanced
IOOP	Intelligent Organization Of PCI
IPMB	Intelligent Platform Management Bus
IPMI	Intelligent Platform Management Interface
iRMC	integrated Remote Management Controller
LAN	Local Area Network
LED	Light Emitting Diode
MCH	Memory Controller Hub
MPS	Multi Processor Specification
NMI	Non Maskable Interrupt
NOS	Network Operating System

Abkürzungen

NVRAM

Non Volatile RAM

ODD

Optical Disc Drive

OEM

Original Equipment Manufacturer

OHCI

Open Host Controller Interface

OS

Operating System

PCI

Peripheral Components Interconnect

PDA

Prefailure Detection and Analyzing

PIO

Programmed Input Output

PLD

Programmable Logic Device

POST

Power-On Self Test

PS(U)

Power Supply (Unit)

PWM

Puls Wide Modulation

PXE

Preboot eXecution Environment

RAID

Redundant Array of Inexpensive Disks

RAM	Random Access Memory
RSB	Remote Service Board
RST	ReSeT
RTC	Real Time Clock
SAS	Serial Attached SCSI
SATA	Serial ATA
SCSI	Small Computer Systems Interface
SDDC	Single Device Data Correction
SDRAM	Synchronous Dynamic Random Access Memory
SHDG	Server Hardware Design Guide
SHPC	Standard Hot Plug Controller
SMB	System Management Bus
SMM	Server Management Mode
SMP	Symmetrically Multi Processing

Abkürzungen

TPM

Trusted Platform Module

UHCI

Unified Host Controller Interface

USB

Universal Serial Bus

VGA

Video Graphics Adapter

VRD

Voltage Regulator Down

VRM

Voltage Regulator Module

WfM

Wired for Management

WOL

Wake up On LAN