

EUREKA

Cordless, Rechargeable VACUUM CLEANER

Household Type

Owner's Guide Model 570A

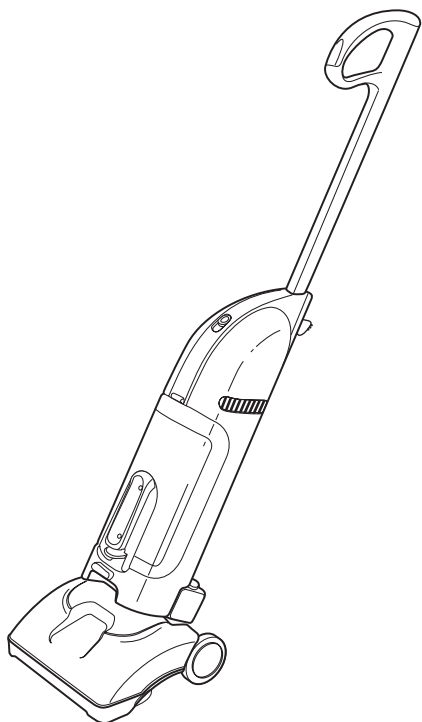

Charge 14-16 hours
before first use.

IMPORTANT

**Do not return this
product to the store.**

**For assembly problems or
questions contact:** Eureka's
Customer Service Division
toll free at 1-800-282-2886*, 7
a.m. to 8 p.m., Central Standard
Time, Monday through Saturday.

**For replacement of broken or
missing items** to be shipped
direct to you, call 1-800-438-
7352*, 8 a.m. to 4:45 p.m.,
Central Standard Time, Monday
through Friday.

***In Mexico call 254 23 52.**

Index

Important Safeguards	2
Service Information	4
Battery Disposal	4
Assembly	5-6
Use & Dust Cup	7
Filter & Charge Battery	8
Brushroll & Blockages	9
Warranty	10
Customer Order Form	11

IMPORTANT SAFEGUARDS

When using an electric appliance, basic precautions should always be followed, including the following:

Read all instructions before using this vacuum cleaner.

WARNING

To reduce the risk of fire, electric shock, or injury:

- Do not use outdoors or on wet surfaces.
- Do not operate the vacuum cleaner or charger that has been damaged in any way. If vacuum cleaner is not working as it should, has been dropped, damaged, left outdoors, or dropped into water, return it to a service center.
- To avoid excessive heat and damage to the unit or batteries, do not operate the vacuum cleaner while charging.
- Do not allow to be used as a toy. Close attention is necessary when used by or near children.
- Use only as described in this manual.
- Use only the charger provided to recharge; MEC model 35-15-150A for 120 volt.
- Do not pull or carry the charger by cord, use cord as a handle, close a door on cord, or pull cord around sharp edges or corners. Keep cord away from heated surfaces.
- Do not use extension cords or outlets with inadequate current carrying capacity.
- Do not unplug by pulling on cord. To unplug, grasp the charger, not the cord.
- Do not handle charger or vacuum cleaner with wet hands.
- **DO NOT MUTILATE OR INCINERATE BATTERIES AS THEY WILL EXPLODE AT HIGH TEMPERATURES.**
- Leaks from battery cells can occur under extreme usage or temperature conditions. If the liquid gets on the skin (1) wash quickly with soap and water or (2) neutralize with a mild acid such as lemon juice or vinegar. If the liquid gets into the eyes, flush them immediately with clean water for a minimum of 10 minutes. Seek medical attention.
- The terminal on the vacuum cleaner should be kept free and clean of objects. While there is no shock hazard from the terminal, a burn could occur if metal objects are inserted into the terminal area.
- This vacuum cleaner creates suction. Keep hair, loose clothing, fingers, and all parts of body away from openings and moving parts.
- Do not pick up anything that is burning or smoking, such as cigarettes, matches, or hot ashes.
- Do not use without a filter in place. When servicing the unit, never put fingers or other objects into the fan chamber in case the unit would accidentally be turned on.
- Use extra care when cleaning on stairs.
- Do not use to pick up flammable or combustible liquids such as gasoline, or use in areas where they may be present.
- Locate charger indoors in a cool, dry area not exposed to the weather to avoid electrical shock and/or cleaner damage.
- Keep your work area well lighted.
- Unplug electrical appliances before vacuuming them.

SAVE THESE INSTRUCTIONS

CONSEILS DE SÉCURITÉ

Lors de l'utilisation d'un appareil électrique, quelques précautions élémentaires doivent être observées, incluant les suivantes:

LISEZ TOUTES LES INSTRUCTIONS AVANT D'UTILISER VOTRE ASPIRATEUR.

AVERTISSEMENT

Pour réduire le risque de feu, de choc électrique ou de blessure:

- N'utilisez pas l'aspirateur à l'extérieur ou sur une surface mouillée.
- N'utilisez jamais l'aspirateur ou le chargeur s'ils ont été endommagés. Si l'aspirateur ne fonctionne pas comme il le faut, s'il a été échappé, s'il a été endommagé, s'il a été laissé à l'extérieur, s'il a été échappé dans de l'eau, retournez-le à un centre de service avant de l'utiliser.
- Pour éviter que l'aspirateur surchauffe, ou que l'aspirateur ou les piles soient endommagés, n'utilisez pas l'aspirateur lorsqu'il est encore dans son support de recharge.
- Ne permettez pas que l'aspirateur soit utilisé comme un jouet. Une attention particulière est nécessaire lorsqu'il est utilisé par ou près d'un enfant.
- Suivez les recommandations d'utilisation de ce manuel.
- Pour recharger l'aspirateur, utilisez uniquement le chargeur qui l'accompagne – Eureka modèle n° 35-15-150A pour 120 volt.
- Ne pas tirer l'aspirateur ou le transporter par le cordon. Ne pas utiliser le cordon en guise de poignée. Ne pas fermer une porte sur le cordon ou tirer le cordon sur des bordures ou des coins pointus. Tenir le cordon à distance des surfaces chauffantes.
- Ne pas utiliser des rallonges ou des prises qui n'ont pas une capacité suffisante pour transporter le courant.
- Ne pas débrancher en tirant sur le cordon. Pour débrancher, empoignez le chargeur et non pas le cordon.
- Ne pas manipuler le chargeur ou l'aspirateur avec les mains mouillées.
- **NE PAS MUTILER OU INCINERER LES PILES. LES PILES EXPLOSENT A DES TEMPERATURES EXCESSIVES.**
- Il peut y avoir des fuites des éléments des piles lorsque celles-ci sont soumises à des conditions d'emploi excessif ou de température excessive. Si le liquide touche la peau (1) laver tout de suite la peau avec de l'eau et du savon (2) Neutraliser avec un acide doux, tel que le jus de citron ou le vinaigre. Au cas de contact avec les yeux, nettoyer à grande eau pour un minimum de 10 minutes. Cherchez des soins médicaux.
- La borne de l'aspirateur doit être maintenue propre et libre de tout autre objet. Il n'y a aucun risque de choc électrique de la borne elle-même, mais une brûlure est possible si des objets en métal sont introduits dans la borne.
- Cet aspirateur crée de la succion. Tenir les parties mobiles et les ouvertures loin des cheveux, des habits, des doigts et de toute partie du corps.
- Ne pas ramasser des objets qui brûlent ou fument comme des cigarettes, des allumettes ou les cendres chaudes.
- Ne pas utiliser sans que le filtre ne soit installé. Lors de réparations ou d'entretien, il ne faut jamais mettre les doigts, ou autres objets, près du ventilateur dans le cas où l'aspirateur serait accidentellement mis en marche.
- Portez une attention particulière lorsque vous nettoyez les escaliers.
- Ne pas utiliser pour ramasser des liquides inflammables ou combustibles comme de l'essence. Ne pas utiliser dans les endroits où ces liquides pourraient être présents.
- Situez le support pour l'aspirateur à l'intérieur, dans un endroit frais, sec et protégé pour éviter le choc électrique ou les dommages.
- Travaillez toujours dans un endroit bien éclairé.
- Débranchez les appareils électriques avant de les nettoyer avec l'aspirateur.

CONSERVEZ CES INSTRUCTIONS

GENERAL INFORMATION

The cordless vacuum cleaner is the answer for quick, convenient, and easy cleanups. Grab the cordless cleaner for convenience rather than using a larger cleaner. Always have the battery recharging either in the unit or out of the unit to provide a ready charge.

**Charge for 14-16 hours before first use.
Batteries could lose charge in shipping.**

It is best to charge the batteries when temperatures are between 32°F (0°C) and 104°F (40°C). Other temperatures could damage batteries.

While charging, the charger may become warm to the touch. This is a normal condition and does not indicate a problem.

Service Information

The instructions in this booklet serve as a guide to routine maintenance. If additional service is required, telephone toll free:

**USA: 1-800-282-2886
Mexico: 254 23 52
Canada: 1-800-282-2886**

for the nearest Eureka Authorized Warranty Station. If you prefer, you can write to The Eureka Company, Bloomington, IL 61701, USA. In Canada write to The Eureka Company, 866 Langs Drive, Cambridge, Ontario N3H 2N7. Refer to The Eureka Warranty for complete service information.



DO NOT OIL. The motor has lubrication and has a permanent seal.

Rating Plate

The model number is indicated on the rating plate which is located on the back of the vacuum cleaner. For prompt and complete service, always refer to these numbers

Model and Type No. _____

Serial No. or Date Code _____

Important Battery Disposal Information - Call 1-800-822-8837 Nickel-Cadmium Batteries

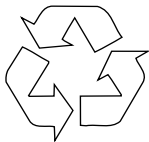

Ni-Cd

Your vacuum cleaner uses nickel-cadmium batteries in a removable pack. To protect our environment, properly dispose of the battery pack when the batteries no longer hold a charge. A municipal waste will not dispose of the battery pack.

Remove the battery pack and take or send it to your nearest Eureka Warranty Service Station. **To learn the address of the nearest factory service center call 1-800-282-2886.**

NOTE: Remove the battery pack only when the batteries no longer hold a charge and you plan to dispose of them.

Identify Parts

NOTE: The charger and battery are in the packing material of the shipping carton.

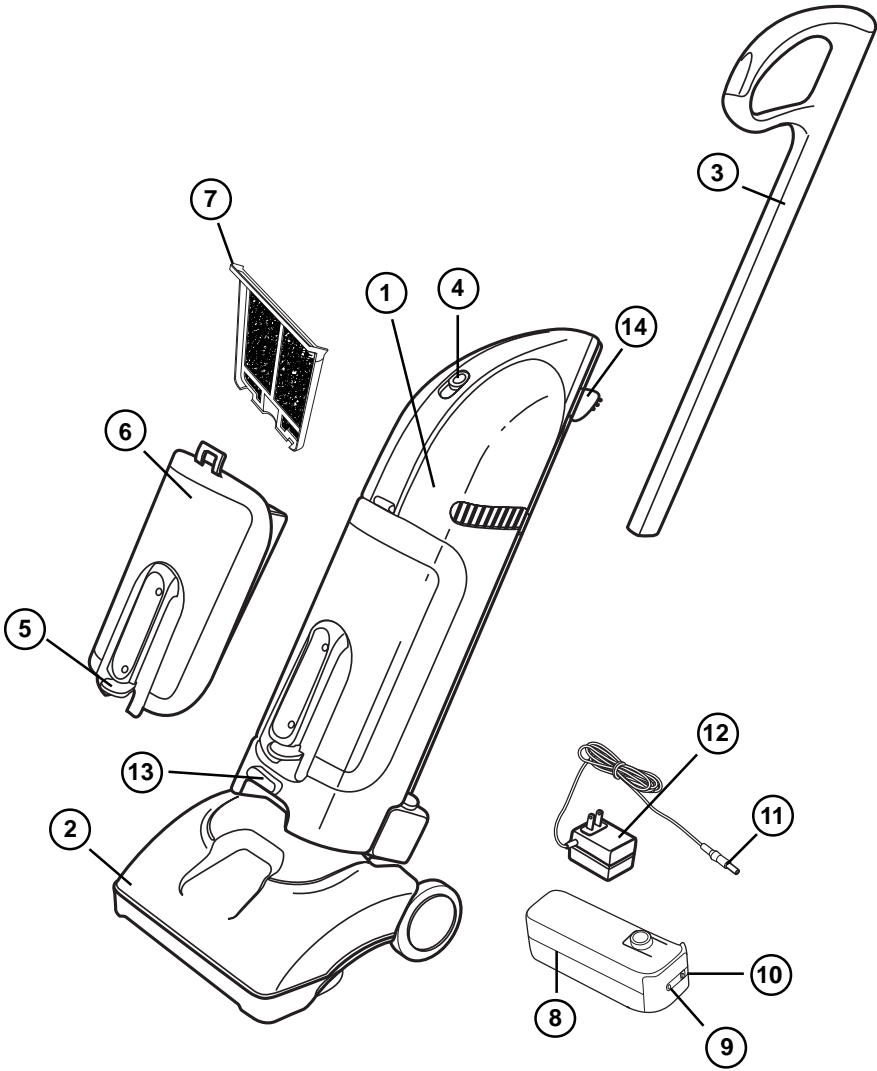

- 1. Body
- 2. Floor Nozzle
- 3. Handle
- 4. On/Off Switch
- 5. Dust Cup Latch
- 6. Dust Cup
- 7. Filter Assembly
- 8. Battery Pack
- 9. Charger connection
- 10. Charge Light for battery
- 11. Charger Plug
- 12. Charger
- 13. Stair Cleaning Hand Grip
- 14. Handle Button

HOW TO ASSEMBLE

Attach Handle

1. Locate the handle and body.
2. Line the handle up with the hole in the top of the body. Flat side of handle and loop forward.
3. Push handle down into body while pressing button on back of the body. Handle will click into place.
4. There are two handle positions available. Handle all the way up and handle all the way down.
5. Button needs to be depressed to raise and lower the handle.

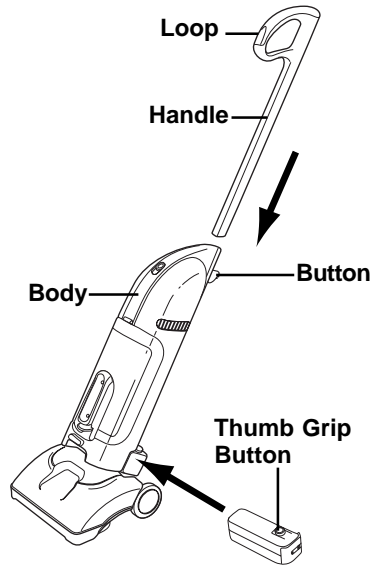

Insert Battery

Hold battery so thumb is positioned on thumb grip button and push completely into body until battery clicks into place.

To Remove Battery

Grasp end of battery using thumb grip and pull out of body.

NOTE: Charge the batteries for 14-16 hours before initial use. A cleaner may lose charge in shipment. The charger body will become warm, however, this is not a cause for concern.

NOTE: For extended battery run time and to prevent long fringe of some area rugs from wrapping around brushroll, place switch in floors (brushroll off) position.

NOTE: Cleaner will not run when charger is connected and battery is in the unit.

CAUTION: To avoid risk of fire, use only genuine Eureka replacement battery packs.

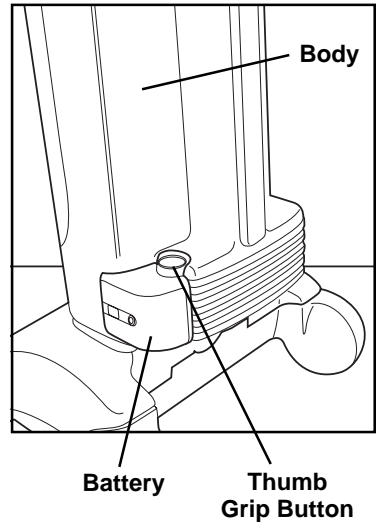

HOW TO USE

Power Switch

The power switch has three positions. Off, Floor (hard surface cleaning) and Carpet.

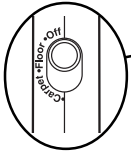

Power Switch

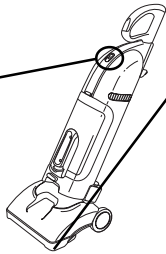

Nozzle with Edge Kleener®

Airflow under the nozzle automatically directs suction to the edges and corners for maximum full width cleaning.

Experiment with your hard floor surfaces, sometimes it is best to have brushroll turning. (Switch in the *carpet* position).

Dual Uses

Push the handle button to release lock. The handle will slide freely until it finds one of the two available handle positions. It automatically locks in either of these two positions.

With the handle collapsed, the unit is great for stairs and compact storage. With the handle extended, the unit is great for floor cleaning.

Stair Cleaning Handle

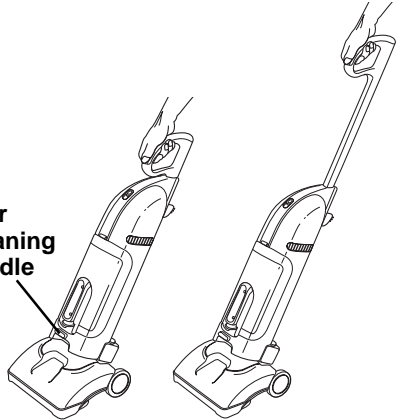

HOW TO MAINTAIN

The instructions given in this booklet serve as a guide to routine maintenance. Keep the cleaner operating at top efficiency. Empty the dust cup after each use.

Empty Dust Cup

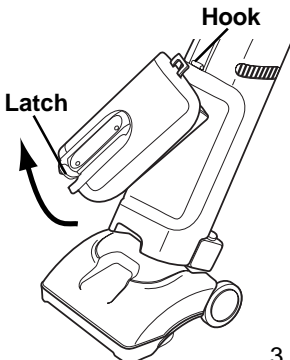

1. Pull dust cup latch up.
2. Swing dust cup out from body and up off the dust cup hook on the body.



3. Leaving dust cup filter in the dust cup, shake contents of dust cup into a waste container. If picking up lots of carpet fuzz or pet hair, remove filter. (To clean dust cup filter refer to dust cup filter section.)

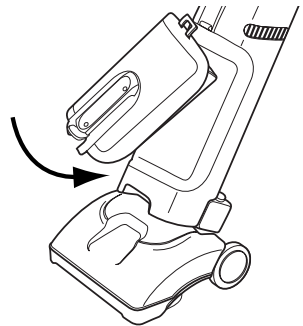

4. To replace dust cup, fit dust cup down onto hook.
5. Swing down and push gently into body until dust cup clicks into place.

HOW TO MAINTAIN (continued)

Clean Dust Cup Filter

Clean the dust cup filter as necessary.

1. Remove dust cup.
2. Slide dust cup filter out of dust cup.
3. Shake and brush the dust and dirt from filter. On the back of the dust cup is a scraper that will help to remove debris from the filter.
4. Replace filter with filter top facing up to ensure proper filter installation.

Replace a dirty or torn filter. Order additional dust cup filters from The Eureka Company, Bloomington, IL 61701. Order dust cup filter, part number 60958.

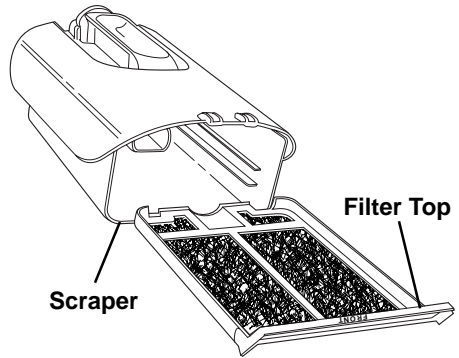

Maintaining a Charge in the Battery

This charger can be used two different ways. One way is with the battery installed in the unit. The other is with the battery out of the unit sitting on a counter or shelf next to an outlet. Once the battery is connected to the charger and the charger is plugged into an outlet, the charge light will glow to indicate that the battery is charging.

Battery Charged in Unit

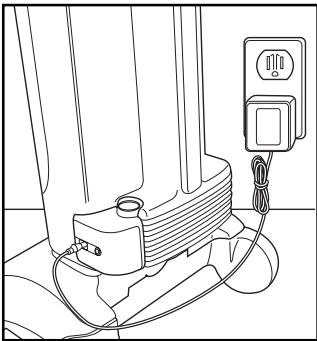

Battery Charged Out of Unit

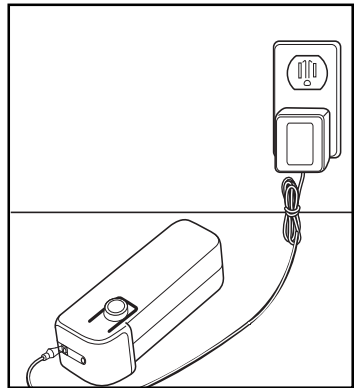

NOTE: The power switch should be in off position while battery is charging.

NOTE: If the battery is charged while in the unit, be certain to disconnect charger plug from battery before lowering handle of cleaner.

NOTE: Cleaner will not run when charger is connected and battery is in the unit.

NOTE: Charger light indicates power is going to battery.

It is all right to leave the cleaner on constant charge so it is always ready to use, but not necessary. Unplug only if it will not be in use for several weeks at a time.

HOW TO MAINTAIN (continued)

Brushroll

NOTE: Turn off switch and remove battery before inspecting brushroll.

Long hair, thread, string, etc. can wrap around the revolving brushroll and result in reduced performance.

To check brushroll for debris turn cleaner nozzle over and inspect for wrapped matter. Use scissors to cut debris from brushroll. When brushroll is clean reinstall the battery and resume operation.

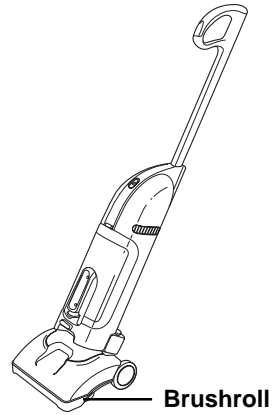

How to Check for Blockages

NOTE: Turn off switch and remove battery before checking for blockages.

If suction performance diminishes and battery is still strong, check for blockages in suction path.

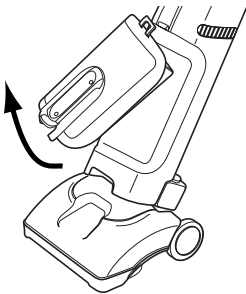

1. Remove dust cup and set aside. Remove battery and set aside.

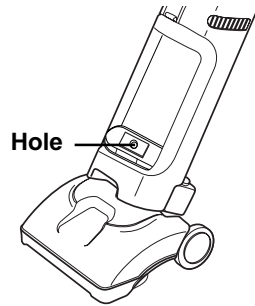

2. Inspect for blockages inside hole area at base of body opening. Use tool or coat hanger to remove blockage.

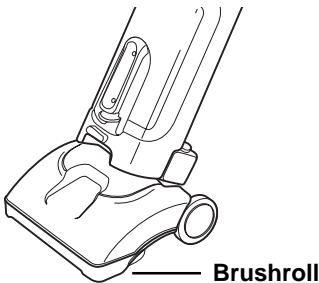

3. Inspect dirt channel in brushroll area leading to body opening. (After removing battery, check for blockages in brush roll area.) Remove blockage with tool or coat hanger.

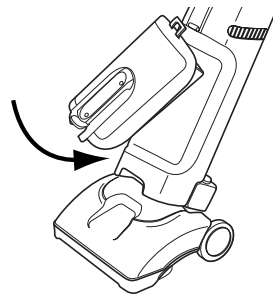

4. Reinstall dust cup and battery.

THE EUREKA LIMITED WARRANTY

What This Warranty Covers

Your Eureka cleaner is warranted to be free from all defects in material and workmanship in normal household use for a period of one year. The warranty is granted only to the original purchaser and members of his or her immediate household. The warranty is subject to the following provisions.

What This Warranty Does Not Cover

- Parts of the cleaner that require replacement under normal use.
- Damages or malfunctions caused by negligence, abuse, or use not in accordance with the Owner's Guide.
- Defects or damages caused by unauthorized service or the use of other than Genuine Eureka parts.

What The Eureka Company Will Do

The Eureka Company will, at its option, repair or replace a defective cleaner or cleaner part that is covered by this warranty. As a matter of warranty policy, the Eureka Company will not refund the consumer's purchase price.

Warranty Registration

Please fill out and return the warranty registration card accompanying your cleaner.

Obtaining Warranty Service

To obtain warranty service you must return the defective cleaner or cleaner part along with proof of purchase to any Eureka Authorized Warranty Station.

You will find the nearest location in the Yellow Pages, under "Vacuum Cleaners—Service and Repair." Be certain that the Warranty Station is "Eureka Authorized."

For the location of the nearest Eureka Authorized Warranty Station or for service information, telephone toll free:

USA: 1-800-282-2886
Mexico: 254 23 52
Canada: 1-800-282-2886

If you prefer, you can write to The Eureka Company, Service Division, 807 North Main Street, Bloomington, Illinois 61701, USA. In Canada write to The Eureka Company, 866 Langs Drive, Cambridge, Ontario N3H 2N7.

If it is necessary to ship the cleaner outside your community to obtain warranty repair, you must pay the shipping charges to the Eureka Authorized Warranty Station. Return shipping charges will be paid by the Warranty Station. When returning parts for repair, please include the model, type, and serial number from the data plate on the cleaner.

Further Limitations and Exclusions

Any warranty that may be implied in connection with your purchase or use of the cleaner, including any warranty of Merchantability or any warranty for Fitness For A Particular Purpose is limited to the duration of this warranty. Some states do not allow limitations on how long an implied warranty lasts, so the above limitations may not apply to you.

Your relief for the breach of this warranty is limited to the relief expressly provided above. In no event shall Eureka be liable for any consequential or incidental damages you may incur in connection with your purchase or use of the cleaner. Some states do not allow the exclusion or limitation of incidental or consequential damages, so the above limitation or exclusion may not apply to you.

This warranty gives you specific legal rights. You may also have other rights which vary by state.



Questions & Answers about Genuine Eureka Products

Q: Why should I use only Genuine Eureka parts in my Eureka product?

A: Using Genuine Eureka Products, which are made to our exacting specifications and engineered with emphasis on quality, performance, and customer satisfaction, ensures the long life and cleaning efficiency of your vacuum cleaner. Overall, this saves you money and helps to keep your home clean.

Q: How can I be sure I am using only genuine Eureka products in my product?

A: Typically, packaged products and paper bags can be identified by a "Genuine Eureka Product" symbol (see illustration above). For further identification assistance, you may call our toll-free number, 1-800-282-2886, for the location of a nearby Eureka Authorized Warranty Station.

Q: Are there any differences between "made to fit" or "imitation" and Genuine Eureka parts?

A: Yes, there are some very important differences in materials, quality, and reliability. Many customers have mistakenly purchased "imitation" paper bags and parts while thinking they purchased genuine. Unfortunately, many of these customers discovered the differences after they experienced related difficulties.

For Genuine Eureka Value, Accept No Imitations!

THE EUREKA COMPANY

Bloomington, Illinois 61701

S O L D T O

Name _____

Address (street address needed for UPS) _____

City _____ State _____ Zip _____

Telephone (Day) _____ (Eve) _____ (Fax) _____

S H I P T O

Name _____

Address (street address needed for UPS) _____

City _____ State _____ Zip _____

Telephone (Day) _____ (Eve) _____ (Fax) _____

To Order



By Phone

1-800-438-7352*

HOURS:
 Call between 8 a.m.
 and 4:45 p.m.
 central standard time

By FAX

1-309-823-5789

*En Mexico
 Llame 254 34 52

By Mail



Simply fill out this
 Order Form.
 Please be sure to
 include day
 and evening
 phone numbers.
www.eureka.com

Genuine Eureka Parts for Model 570			
Model Number	Part No.	Qty.	Price (USD) Total
_____	60958		2.99
_____	60960		17.39
_____	60955		9.99
_____	60956		30.69
_____	60957		2.99
_____	60959		9.19
_____	60961		10.19
Total (prices subject to change without notice)			
Tax (add state and local taxes as required by law)			
Postage and Handling Charge (Within the U.S.A.)			\$3.75

To Answer Problems or Questions for U.S.A. and Canada call:
1-800-282-2886*
 7 a.m. to 8 p.m. central standard time Monday through Saturday

Method of Payment (No C.O.D.s)

- Check or money order (payable to The Eureka Company). Do not send currency.
- Charge to my Visa (13/16 digits) MasterCard (13 digits) American Express (15 digits)
- Acct. number _____ Expiration date _____

Signature (Full name as shown on account) _____

TOTAL

