

Contents

Regulatory Information	2	Resetting to Factory Default	
Description of Warning Symbols	2	Settings.....	14
Safety Notices	2	3. Adjusting On-Screen Display (OSD) Settings	15
Preface	4	• On-Screen Menus Selection.....	16
Warranty and Service / Repair	4	• Media Center Menu	21
Cleaning	4	Viewing Photos	21
1. Getting Started	5	Playback Music.....	22
• Package Contents	5	Watching Videos	22
• Introducing the TV	5	• Time Shift Function	22
• Features.....	5	• PVR (Personal Video Record)	23
• Foot Stand Installation	6	4. Troubleshooting	24
• Disconnecting the Stand.....	6	5. Support Timing	25
• Installing the Wall Mount Kit.....	7	6. Specifications	25
• Control Panel	8		
• Input and Output Jacks.....	9		
• Remote Control.....	10		
2. Setting up your TV	11		
• Power Connection	11		
• Rear Connections	11		
• Using the TV	12		
Turning the TV On and Off.....	12		
Running Setup Wizard.....	12		
Selecting Your Content Source....	13		
Performing an Automatic Channel Search	13		
Setting Up Your Favorite Channels.....	13		
Adjusting the ECO Dynamic Backlight	14		
Using the PAP Function	14		
Customizing the Input Settings	14		
Changing Your Location.....	14		

Regulatory Information

CE Conformity Statement

This device is in conformity with the requirements of EU Council Directive 2004/108/EC on the approximation of the laws of the Member States relating to electromagnetic compatibility and Directive 2006/95/EC on the harmonization of the laws of Member States relating to electrical equipment for use within certain voltage limits. Hannspree cannot accept responsibility for any failure to satisfy the requirements resulting from a non-recommended modification of the device.



Description of Warning Symbols

WARNING

This symbol is used to alert users to pay attention to important descriptions regarding usage, maintenance (repair), and additional important information related to this TV.

CAUTION

This symbol is used to alert users to the risk of electric shocks due to dangerous and uninsulated components.

Safety Notices



Installation Safety Notes

Location

Avoid allowing the TV to get prolonged exposure to sunlight or other strong sources of heat. Leave sufficient distance between the TV and the wall to provide enough space for the emission of heat.



To reduce the risk of fire or electric shock, do not expose this apparatus to rain or moisture. Apparatus shall not be exposed to dripping or splashing and no objects filled with liquids, such as vases, shall be placed on the apparatus.



These servicing instructions are for use by qualified service personnel only. To reduce the risk of electric shock, do not perform any servicing other than that contained in the operating instructions unless you are qualified to do so.



To prevent the spread of fire, keep candles or other open flames away from this product at all times.

Installation

- Do not place the TV in locations where there is excessive steam or dust.
- Avoid blocking the TV's vents, do not place the TV on a bed, sofa, carpet, or in a sealed cabinet.
- Install the outdoor antenna away from power transmission lines to avoid possible danger.

Personal Safety

- To avoid overloading the power supply, never plug too many electrical devices into an outlet, power strip, or extension cable.
- Dangerous high-voltage electric power components are located inside the TV. To avoid electric shock, do not disassemble the casing.
- Do not place or drop metals, small objects, or flammable materials into the vent of the TV.
- If the TV is dropped, falls down, or is otherwise damaged, unplug the power cord immediately and contact an authorized service technician.
- If any fluid is sprayed or dropped into the TV, contact an authorized service technician.
- The screen of the TV is made of glass. Avoid hitting or scraping it. If the screen is broken, do not touch the broken glass.
- Do not allow children to use the TV unattended.
- Be careful when disconnecting the power plug. Hold the plug. Do not attempt to disconnect the plug by pulling on the power cord.
- Batteries shall not be exposed to excessive heat such as sunshine, fire or the like.
- A warning that excessive noise when using earphones and headphones can cause a loss of listening.



Trademark Notice

HDMI Hannspree products incorporate High-Definition Multimedia Interface (HDMI™) technology.

HDMI, the HDMI Logo, and High-Definition Multimedia Interface are trademarks or registered trademarks of HDMI Licensing LLC in the United States and other countries.



Manufactured under license from Dolby Laboratories. Dolby and the double-D symbol are trademarks of Dolby Laboratories.



The "HD TV" Logo is a trademark of DIGITALEUROPE. (AD32U)



"DVB and the DVB logos are trademarks of the DVB Project".

"The Freeview words and logos are trade marks of DTV Services Ltd and are used under licence. © DTV Services Ltd."

The CI Plus Logo is a trademark of CI Plus LLP.



- Where the mains plug or an appliance coupler is used as the disconnect device, the disconnect device shall remain readily operable.
- If the remote control is not used for a long period, remove the batteries and store them properly.
- Handle damaged or leaking batteries carefully, and wash hands with soap if they come in contact with leaked chemical fluids.
- If your remote control has two batteries, do not mix new and old batteries, or the life of the new batteries will be shortened. Chemical fluids may leak from the old batteries.
- Danger of explosion if battery is incorrectly replaced. Replace only with the same or equivalent type recommended by the equipment manufacturer. Discard used batteries according to manufacturer's instructions.
- Refer to your local recycling or waste disposal rules and contact a local waste disposal vendor to dispose of used batteries.
- The remote control cover may have a magnet in it, so do not place magnetic sensitive items such as watches, credit cards, or flash media close to the cover.
- Do not use force when pulling the remote control cover open; you may damage the hinge.

Copyright

© Copyright 2011 Hannspree, Inc.

All rights reserved. This manual is protected by copyright and distributed under licenses restricting its use, copying and distribution. No part of this manual may be reproduced in any form by any means without the prior written authorization of Hannspree. The TV described in this manual may include copyrighted software of Hannspree (or other third parties). Hannspree (or other third parties) preserves the exclusive rights for copyrighted software, such as the right to distribute or reproduce the copyrighted software. Accordingly, and to the extent allowed by applicable law, any copyrighted software contained in the product described herein shall not be distributed, modified, reverse engineered, or reproduced in any manner without the prior written authorization of Hannspree (or of other third parties).

The Hannspree logos presented herein are trademarks of Hannspree. All other product names, trademarks or logos mentioned herein are used for identification purpose only, and may be the trademarks or registered trademarks of their respective owners.

The purchase of the product described herein shall not be deemed to grant, either directly or by implication, estoppel or otherwise, any license under the copyrights, patents, patent applications or trademarks of Hannspree, except for the normal, non-exclusive use that arises by operation of law in the sale of a product.

RECYCLING INFORMATION

We, the Hannspree care very much about our environment protection strategy and firmly believe that it helps us have healthier earth via appropriate treatment and recycling of industrial technology devices at the end-of-life.

These devices contain recyclable materials, which can be re-decomposed and re-integrated into brand-new marvels. On the contrary, other material can be classified to hazardous and poisoned substances. We strongly encourage you to contact the provided information to recycle this product.

For more information, please visit

www.hannspree.com/



According to WEEE regulation, this TV can't be handled as normal trash in Europe when it is out of usage. Please refer to the recycle information from our website to handle it.

Notes:

- The LED TV is for entertainment use only and visual display tasks are excluded.
- This device uses a VGA connector to connect to a PC. To reduce the influence of main frequency on the source signal, use a VGA monitor cable with ferrite shield.

Preface

Thank you for purchasing a Hannspeer LED TV. Your new TV will allow you to enjoy superior audio and video while enriching your lifestyle with advanced technology.

Please carefully read this manual in its entirety before setting up, using or operating your TV. To ensure the safe and correct installation and operations of the TV, it is important that the safety and operation instructions in this manual are followed.

This instruction manual is designed to assist you in setting up and using the TV. The information in this manual has been carefully checked for accuracy; however, no guarantee is given to the correctness of the contents. The information in this manual is subject to change without notice.

To the extent allowed by applicable law, Hannspeer, Inc. ("Hannspeer") shall not be liable for direct, indirect, special, exemplary, incidental or consequential damages arising from any defect or omission in this manual, even if advised of the possibility of such damages in advance.

Warranty and Service / Repair

For complete warranty service information, please refer to the "Warranty Card" enclosed with your TV.

Service and Repair Information for United Kingdom:

Should the need for service arise, please contact HANNspeer Technical Service Center and refer to the warranty card for the Terms and Conditions.

Please visit HANNspeer Europe Website:

<http://www.hannspeer.com/eu>

and go to the "Service" – "Repair Service" section.

Packing Material Disposal:

Please refer to your local laws and directives to ensure an environmentally safe disposal.

Keep this manual for later use.

Cleaning**Instruction for cleaning the TV**

- 1 Clean your TV frequently with a soft cloth to remove dust and dirt. More persistent dirt can be removed with a moist cloth with soft soap.
- 2 Do not use detergents or any other aggressive cleaning. This might damage the housing or screen surface.

1. Getting Started

Package Contents

Make sure the following components are included in the box. Please contact Hannspree Customer Service immediately if anything is missing or damaged.

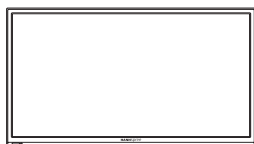

TV



User's manual



Quick start guide

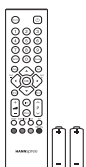

Warranty card

Remote control
and batteries

SCART adapter

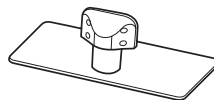

TV stand

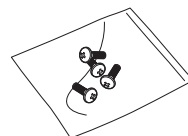

Screws



Simple screwdriver

Introducing the TV

You can watch DVB-T, DVB-C broadcast, cable, or digital television channels, and easily connect a VCR, STB or DVD player to the SCART, HDTV (Component), and HDMI input ports (location of these ports depends on model). You can also use the TV as a monitor for your PC by connecting it through the VGA port.

Convenient control buttons located on the TV and a handy remote control let you change channels, adjust the volume, and change display settings through an easy-to-use on-screen display menu system. The built-in stereo speakers provide full rich sound and a convenient audio output port lets you connect to an external audio system or earphones.

Features

- TV Tuner: Built-in TV Tuner (analog, DVB-T, DVB-C)
- Audio/ Video support:
 - SCART input
 - VGA (PC) input
 - HDMI inputs
 - HDTV (Component) input
 - R/L audio inputs
 - VGA(PC) audio input
 - 3.5 mm stereo earphone output
 - SPDIF output
- On-Screen Display (OSD) menu system
- Teletext (TV RF+SCART) 1.5v. with 1000 pages memory
- Built-in stereo speakers
- Image Enhancement Technology
 - 3:2/2:2 pull down (24P)
 - 3D Comb Filter
- Noise Reduction
- Advanced 3D de-interlacing
- Edge Enhancement
- HDTV (32")
- PVR and Time Shift functions

Note:

- The supporting devices mentioned in this manual may vary on different models. For more information, please refer to the manufacturer's user manual or the Quick Start Guide of your TV model.

Foot Stand Installation

- 1 Carefully place the TV screen side down on a cushioned surface to protect the screen from damage.
 - Install only with another person's assistance.
 - Make sure to distinguish between the front and back of the stand when assembling them.
- 2 Attach the foot stand and secure it with the included screws. Please fasten with a cross screw driver.

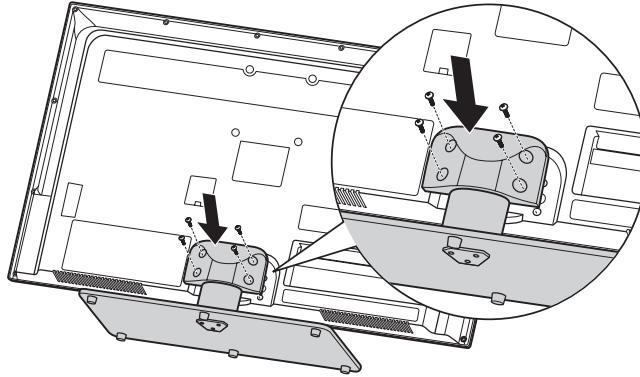

Disconnecting the Stand

- 1 Carefully place the TV screen side down on a cushioned surface to protect the screen from damage.
- 2 Remove the screws and detach the stand from the TV.

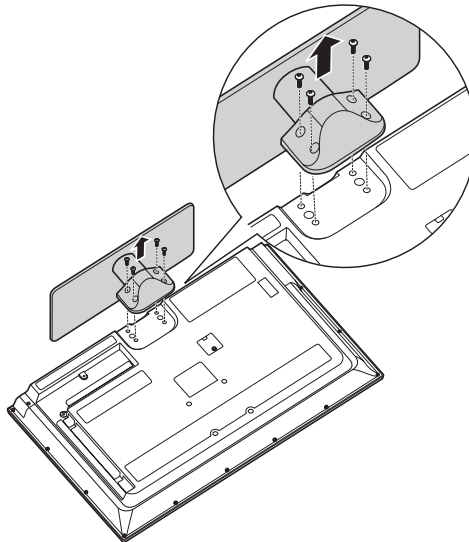

Installing the LED TV requires special skill that should only be performed by qualified service personnel. Customers should not attempt to do the work themselves. Hannspeer bears no responsibility for improper mounting or mounting that results in accident or injury. You can ask a qualified service personnel about using an optional bracket to mount the TV to the wall.

Installing the Wall Mount Kit

Wall mount items (sold separately) allow you to mount the TV on the wall. For detailed information on installing the wall mount, see the instructions provided with the Wall Mount items. Contact a technician for assistance when installing the wall mounted bracket. Hannspree is not responsible for any damage to the product or injury to yourself or others if you select to install the TV on your own.



- Do not install your Wall Mount Kit while your TV is turned on. It may result in personal injury due to electric shock.

VESA-compatible wall bracket (WxH)	Mount holes number	Screw type	Maximum loading
100x100 mm	4	Metric 4 x 12 mm	60 kg

- 1 Purchase a VESA compatible wall bracket (please refer to the table above).
- 2 Locate your ideal TV position on the wall.
- 3 Fix the wall bracket firmly on the wall.
- 4 Secure the TV to the bracket using the 4 mount holes on the back and center of the TV.

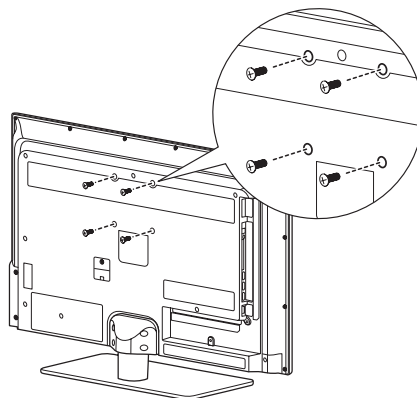

Securing the Installation Space

Keep the required distances between the product and other objects (e.g. walls) to ensure proper ventilation. Failing to do so may result in fire or a problem with the product due to an increase in the internal temperature of the product. Install the product so that the required distances shown in the figure are kept.

- When using a stand or wall-mount, use parts provided by Hannspree only.

When installing the product with a stand

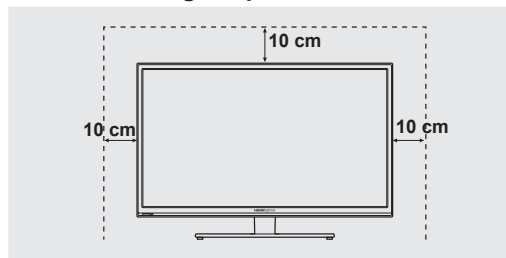

When installing the product with a wall-mount

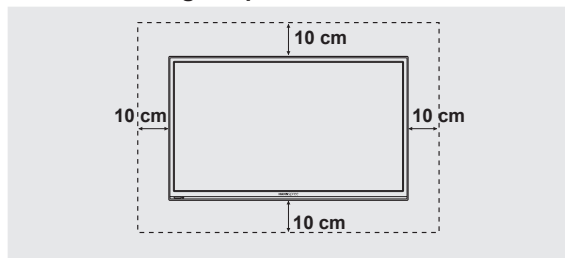

Note:

- Please read the instructions of your specific wall bracket to properly wall mount the TV.



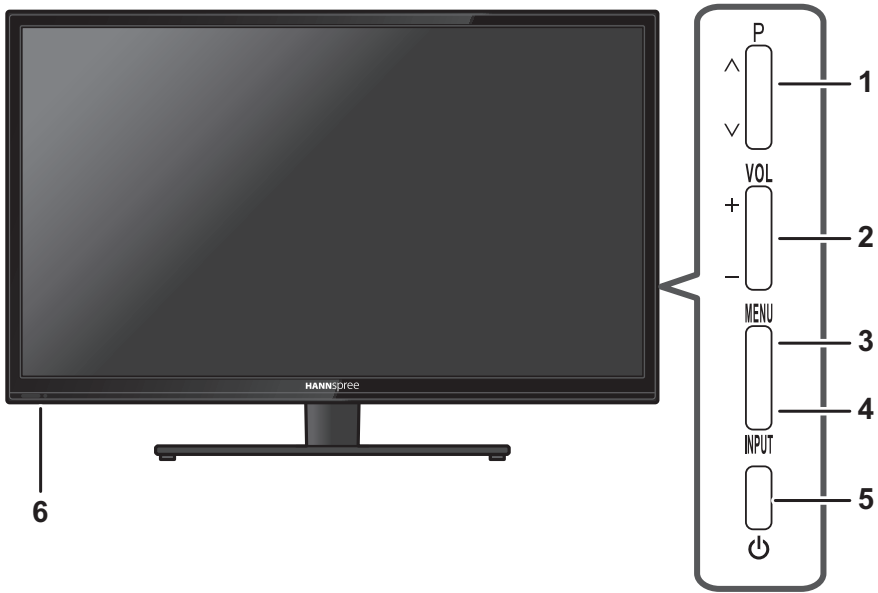









Control Panel

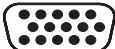

No.	Description	Button	Function
1	Program select	P ^	Press to increase the program number or move upward to the previous item on the OSD menu. During standby mode, press to turn the TV on.
		P v	Press to decrease the program number or move downward to the next item on the OSD menu. During standby mode, press to turn the TV on.
2	Volume adjust	VOL +	Press to increase the volume or move to the right on the OSD menu.
		VOL -	Press to decrease the volume or move to the left on the OSD menu.
3	Menu	MENU	Press to turn the on-screen display (OSD) menu on / off.
4	Input	INPUT	Press to confirm the selection on the OSD menu.
5	Power		Press to turn the TV on or off.
6	Light sensor and Remote IR sensor		Used to detect the current level of visible light in the surrounding environment. Receive incoming remote control commands.

Input and Output Jacks

Please refer to the front cover illustration for the Input & Output location.

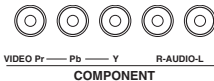
No.	Description	Connector	Function
1	SPDIF		Connect to a digital audio output device such as a home theater.
2	Earphone Output		Connect to earphones or external speakers with built-in amplifier.
3	CI	 CI SLOT	Connect to a CI device (the CI slot as CI+).
4	HDMI 1/HDMI 2/ HDMI 3 Input	  	Connect an HDMI equipment or an HDMI-DVI adapter cable to devices such as a DVD player or set-top box.
5	USB	 USB 	Connect to a USB device such as a USB flash drive or USB hard disk drive.
6	VGA (PC IN)		Connect to a PC's VGA port.
7	Cable/Antenna		Connect to an antenna or cable TV.
8	SCART Adapter		Connect to an external device, such as a VCR, STB, or a DVD player using the included SCART adapter cable.
9	PC Audio Input		Connect to a PC's line / audio port.
10	Component Inputs	 VIDEO Pr — Pb — Y — R-AUDIO-L COMPONENT	Connect to an external device, such as a VCR, STB, or a DVD player.

Remote Control

1 Source

Press to select the input signal type selections.

2 Keypad

Press to select a program directly. Press 0-9 to enter the program numbers (press 1 and 0 for program 10).

3 ECO

Press to toggle ECO dynamic backlight setting.

4 Menu

Press to access the main menu, return to the previous menu, or exit the menu screen.

5 Arrows

▲ ▼ To navigate in the main menu, to select menu options, to switch to the previous or next photo, song, or video in USB mode.

◀ ▶ (*Zoom +/-) To navigate in the main menu; to set functions and change values. ▶ can also be used to open the corresponding submenu. * To select the picture format.

6 Option

Press to display the Quick Access menu: Picture preset, Sound preset, Time shift, PVR, Schedule list, and USB.

7 Info

Press to display program information (if available).

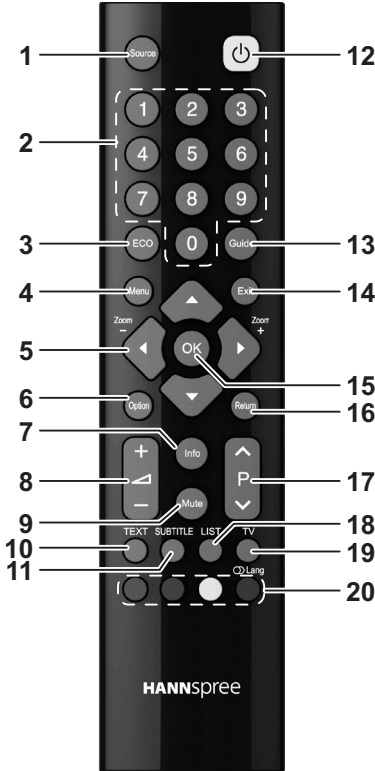

8 Volume adjust

Press + to increase audio volume. Press - to decrease audio volume.

9 Mute

Press to toggle the sound off and back on again.

10 Teletext mode

Press to toggle teletext on or off.

11 Subtitle

With an ATV source, if teletext mode is activated and the teletext has a subtitle page, press to display the subtitle page. With a DTV source,

press to select a subtitle language available for selected digital TV program.

12 Power

Press to turn the TV on or off.

13 Guide

Press to display detailed programming information for channels (only for DTV).

14 Exit

Press to exit the menu screen or Teletext.

15 OK

Press to enter a submenu or activate a setting; to freeze/unfreeze the picture in digital TV mode.

16 Return

Press to return to the previous channel; to return to the previous menu in USB function.

17 Select program

Press P ▲ to increase the program number. Press P ▼ to decrease the program number.

18 List

To display channel list.

19 TV

Press to access conventional analogue TV mode.

20 Color buttons

Press the colored buttons to perform specific tasks in the OSD menu or teletext mode. **Blue (Lang):** To select a sound type available for selected analog TV program, to select an audio language available for selected digital TV program.

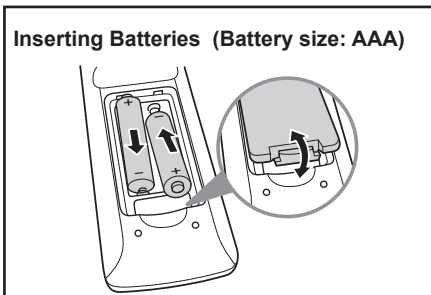

Notes:

- For best results, use the remote control within a proper distance from the front of the TV. Do not exceed an angle of 30 degrees when pointing at TV.
- The operational distance may be shortened when the signal sensor is directly exposed to strong light.
- Aim the transmitter on the remote control at the signal sensor and ensure that there are no obstacles between them.

2. Setting up your TV

Power Connection

Insert the plug at the end of the power cord into a power outlet.

Rear Connections

See the illustration and table below for device connection instructions.

Connection Order	
HDMI is the best way to connect a device. If it's not available, move down the list in order until you find a connection that's available on each device.	
1	HDMI
2	Component
3	SCART

* Typical Layout

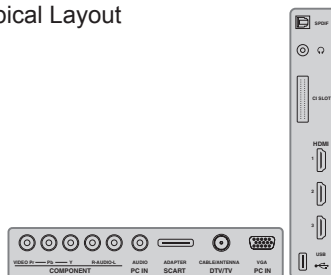

1 HDMI

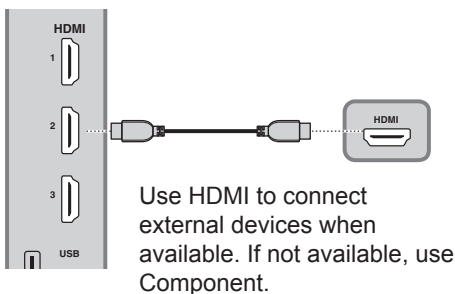

2 Component

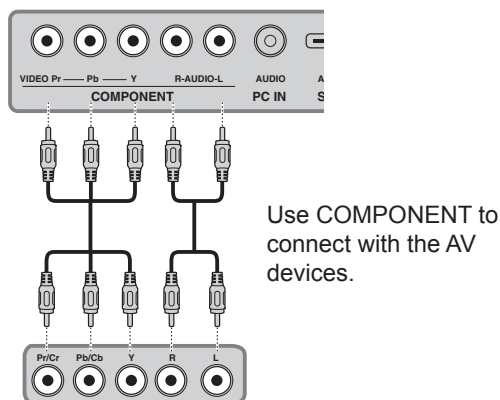

3 SCART

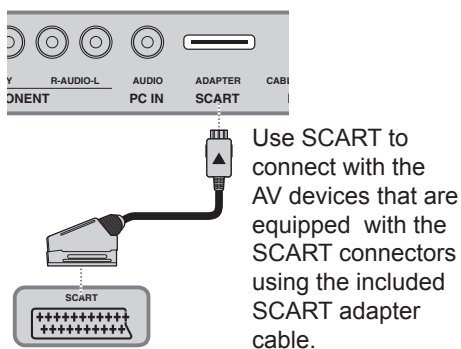



Antenna/Cable
Use this connection when you need to connect directly to an antenna or cable system instead of using a cable box.

Be careful not to bend the copper wire.

Using the TV



Turning the TV On and Off

- 1 Press  on the control panel or remote control to turn the TV on.
- 2 Press  again. The power LED turns red, indicating that the TV is off.

Running Setup Wizard

The Setup Wizard is displayed on the screen when you turn on your LED TV for the first time.

Note:

- Press / on the remote control to move through the menu. Press **OK** to select.

- 1 The Wizard appears to guide you through the initial setup. Press **OK** to start.

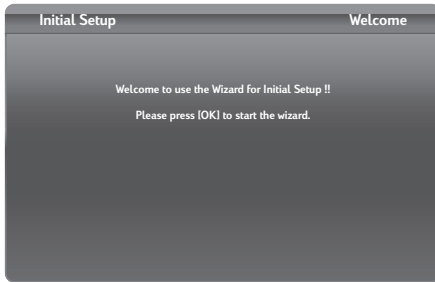

- 2 Select your language for the on-screen display (OSD) menu.

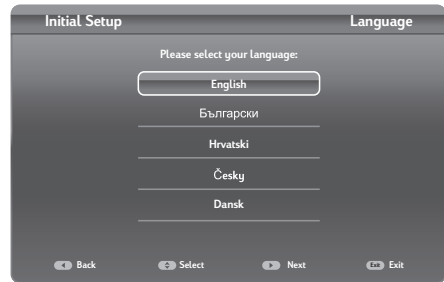

- 3 Select your country.

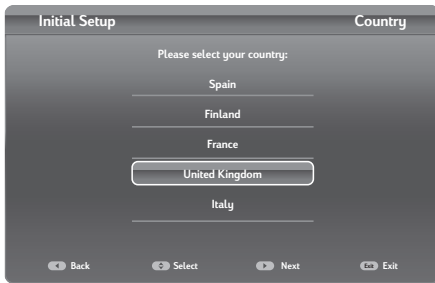

- 4 Select your tuner mode.

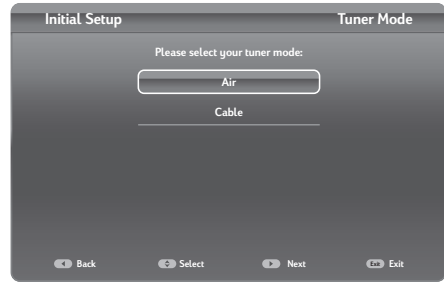

- 5 Select **Scan** and press **OK** for channel scan.

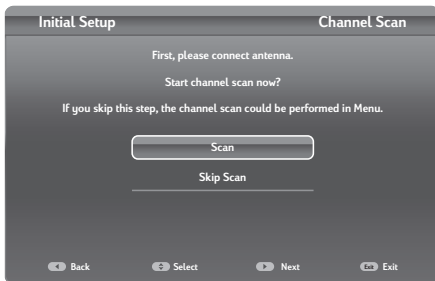

- 6 The channel scan may take a while to complete.

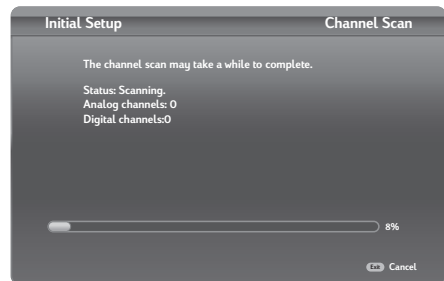

- 7 Once the automatic search ends, select your location.

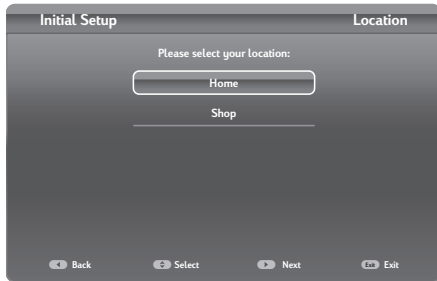

- 8 Press **OK** when initial setup is completed.

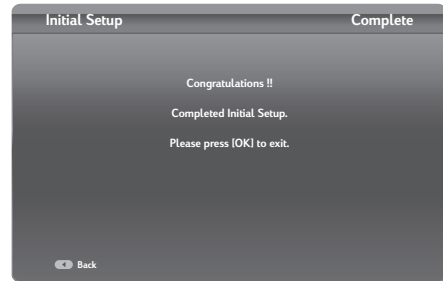

Note:

- In Home mode, TV will be powered off automatically if there is no operations in 4 hours.

Selecting Your Content Source

You can watch cable or broadcast TV, play DVD or connect to your PC. To select the source signal:

- Press **Source** on the remote control. The Input Source menu appears.
- Press **▲/▼** to highlight the desired source, then press **OK** to confirm.

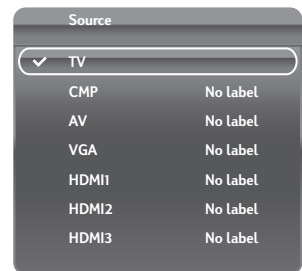

Performing an Automatic Channel Search

Before using the TV to view programs, you need to activate the channel search first.

- 1 Press **MENU** on the control panel or press **Menu** on the remote control to enter the **TV** menu.
- 2 Select **Tuner mode**.
- 3 Select **Channel install > Automatic search**.
- 4 Select **Country** and press **OK**.
- 5 Select the signal type.
- 6 Press **OK/▶** on the remote control to run the channel search.

Setting Up Your Favorite Channels

- 1 Press **LIST**.
- 2 Press the yellow button to enter **Channel list** selection. Press **▲/▼** to select the favorite list you want to set up your favorite channels. Then press **OK** to enter the selected list.
- 3 Press the blue button to start to edit your favorite list. Press **▲/▼** to scroll through the channel list and press **OK** to select it.
 - Repeat this procedure to setup other favorite channels.
- 4 Press **LIST/Exit** to exit.

Adjusting the ECO Dynamic Backlight

- 1 Press **Menu** on the remote control to display the main menu.
- 2 Select **Picture > ECO Dynamic back light**.
- 3 Press **◀/▶** to select the desired setting. At this time, the **Picture preset** option under Picture will be set at **Personal** synchronically.
- 4 Press **Exit** to close the menu.

Using the PAP Function

- 1 Press **Menu** on the remote control to display the main menu.
- 2 Select **Setup > PAP** and press **OK/▶** to enter its submenu.
- 3 To activate the PAP function, press **◀/▶** to select **On**.
- 4 Press **◀/▶** to set the position of the TV window.
- 5 Press **◀/▶** to toggle the focus window.
- 6 When focus is on TV window, the digit buttons and **P ^/P ∨** work in TV. When focus is on other windows, **P ^/P ∨** can change available extension sources.

Focus window position indicator

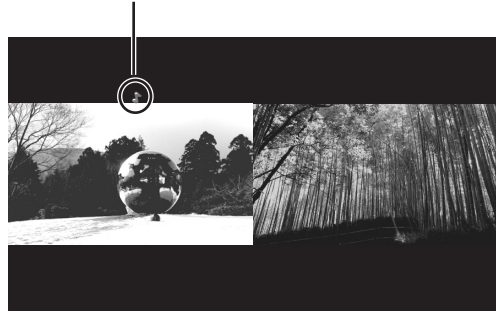

Customizing the Input Settings

- 1 Press **Menu** on the remote control to display the main menu.
- 2 Select **TV > Input settings** and press **OK/▶** to enter its submenu.
- 3 Press **▲/▼** to select a connector your equipment is connected to.
- 4 Press **◀/▶** to select the device type that is attached to this connector.
- 5 Press **Menu** to return to the **TV** menu.

Note:

- After configuring the above setting, the selected source label will be displayed after the name selected in the source list.

Changing Your Location

- 1 Press **Menu** on the remote control to display the main menu.
- 2 Select **Setup > Location**.
- 3 Press **◀/▶** to select your location (**Shop** or **Home**).
- 4 Press **Exit** to close the menu.

Resetting to Factory Default Settings

- 1 Press **Menu** on the remote control to display the main menu.
- 2 Select **TV > Reset** and press **OK/▶** to enter its submenu.
- 3 Use the digit buttons to enter the password.
- 4 Press **◀/▶** to select **OK** and press **OK** to confirm.
- 5 The **Initial setup** menu appears. Follow the on-screen instructions.

Note:

- The default password is 1234.

3. Adjusting On-Screen Display (OSD) Settings

The On-Screen Display (OSD) menu system provides a quick and simple method to adjust the TV settings. The OSD menu can be accessed conveniently through the buttons on the remote control.

Before going into details of each OSD option, you may get acquainted with the placement of the OSD system:

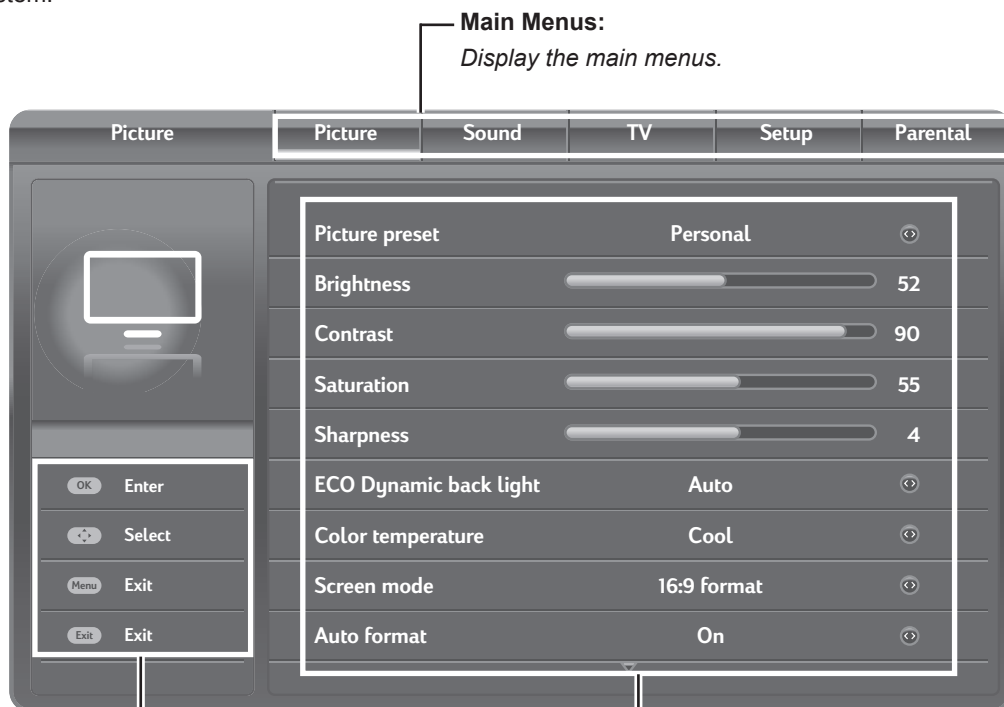

Function	TV Control Panel	Remote Control
OSD Menu	MENU	Menu
Up	P ▲	Arrow ▲
Down	P ▼	Arrow ▼
Select/ Increase	VOL +	Arrow ►
Select/ Decrease	VOL -	Arrow ◀
Return	MENU	Menu

On-Screen Menus Selection

Follow the instructions indicated on the left side of the OSD Function Menu.

- Press **P** \wedge / **P** \vee on the control panel or \blacktriangle / \blacktriangledown arrow keys to scroll through the menus.
- Press **VOL +** on the control panel or the \blacktriangleright arrow key to enter a correspond submenu.
- Press **VOL +**/**VOL -** on the control panel or the \blacktriangleleft / \blacktriangleright arrow keys to adjust the desired setting.
- Press **MENU** on the control panel repeatedly or **Exit** to exit the OSD menu.

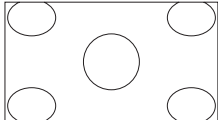
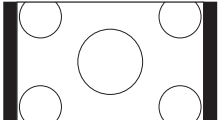
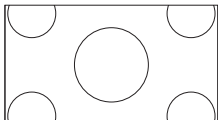
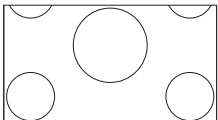
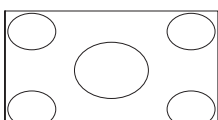
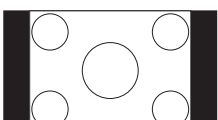
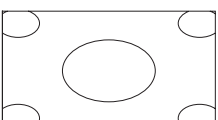
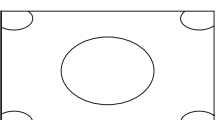
Picture	
Option	Description
Picture preset	Select a preset view option optimized for different viewing conditions (ECO/Vivid/Studio/Personal/Movie).
Brightness	Adjust the base level of the signal in the picture (0~100).
Contrast	Adjust the gradient of the video signal (0~100).
Saturation	Adjust the color intensity (0~100).
Tint (only shown on NTSC system)	Adjust the balance of the red, green, and blue colors of the display (-32~32).
Sharpness	Adjust the sharpness or softness of the display (0~7).
Eco Dynamic back light	Select the ECO Dynamic back light setting (Auto/Low/Middle/High).
Color temperature	Select the color temperature in the display (Normal/Warm/Cool).
Screen mode	<p>Select the aspect ratio of the display (Cinerama/ 14:9 Zoom/16:9 Zoom/16:9 Zoom up/ 16:9 format/ 4:3 format/Wide Zoom/Zoom 2/Wide Zoom 2/ Stretch Zoom).</p> <div style="display: flex; justify-content: space-around; align-items: flex-start;"> <div style="text-align: center;"> <p>Cinerama</p>  </div> <div style="text-align: center;"> <p>14:9 Zoom</p>  </div> </div> <div style="display: flex; justify-content: space-around; align-items: flex-start; margin-top: 10px;"> <div style="text-align: center;"> <p>16:9 Zoom</p>  </div> <div style="text-align: center;"> <p>16:9 Zoom up</p>  </div> </div> <div style="display: flex; justify-content: space-around; align-items: flex-start; margin-top: 10px;"> <div style="text-align: center;"> <p>16:9 format</p>  </div> <div style="text-align: center;"> <p>4:3 format</p>  </div> </div> <div style="display: flex; justify-content: space-around; align-items: flex-start; margin-top: 10px;"> <div style="text-align: center;"> <p>Wide Zoom</p>  </div> <div style="text-align: center;"> <p>Zoom 2</p>  </div> </div>

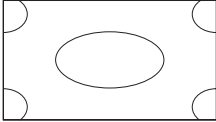
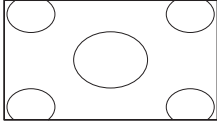
Screen mode	Wide Zoom 2		Stretch Zoom	
Auto format	Enable/disable the aspect ratio selection automatically (On/Off).			
Advanced video	Noise reduction	Reduce the noise level (High/Off/Low).		
	Light sensor	Enable/disable the light sensor to detect the current level of visible light in the surrounding environment (On/Off).		
VGA (only shown on VGA source)	Auto adjust (Synchronize the display automatically).			
	H. Position	Adjust the position of the image left and right (0~100).		
	V. Position	Adjust the position of the image up and down (0~100).		
	Phase	Adjust to reduce horizontal noise (0~31).		
	Clock	Adjust to reduce vertical noise (0~255).		
Active Contrast	Enable/disable Active Contrast function (Automatic backlight control function based on average luminance of input pattern) (On/Off). <i>* If Active Contrast was set as On, the ECO Dynamic back light & Light sensor function will be disabled.</i>			
Note: The options available on the OSD may vary depending on the input signal source.				

Sound			
Option	Description		
Sound preset	Select a preset audio option optimized for different sounding conditions (Rock/Pop/Live/Dance/Techno/Classic/Soft/Personal/Off).		
Balance	Adjust the sound balance between the left and right speakers (-50~50).		
Audio delay	Adjust the audio delay setting in millisecond (0~1000). <i>* This option is only available for digital channels.</i>		
Wide stereo	Enable/disable the wide stereo feature (On/Off).		
Auto volume control	Select to automatically adjust the volume. <i>* This option will only appear when the input source is TV.</i>		
Sound type	Select the sound type setting (Stereo/Dual1/Dual2/Mono).		
Type	Select the sound type mode (Normal/Visually impaired).		
Visually impaired (only available when Type is set to Visually impaired)	<table border="1"> <tr> <td>Speaker</td> <td>Turn on or off the speaker (On/Off).</td> </tr> </table>	Speaker	Turn on or off the speaker (On/Off).
Speaker	Turn on or off the speaker (On/Off).		

Visually impaired (only available when <i>Type</i> is set to <i>Visually impaired</i>)	Headphones	Turn on or off the headphones (On/Off).
	Volume	Adjust the volume level (0~100).
Note: The options available on the OSD may vary depending on the input signal source.		

TV		
Option	Description	
Language	Menu language	Set the on-screen display language.
	Preferred audio language	Set the audio language.
	Preferred audio language 2nd	Set the second audio language.
Country	Select your country.	
Tuner mode	Air/Cable	Select the tuner mode type.
Channel install	Automatic search	Scan the channel search automatically based on the selected tuner mode.
	Automatic update	Update the channel search automatically if you are receiving TV channels with an antenna. <i>* only on Air mode</i>
	Analog manual scan	Scan the analog channel search manually.
	Air manual installation	Scan the channel search manually if you are receiving TV channels with an antenna. <i>* only on Air mode</i>
	Cable manual installation	Scan the channel search manually if you are receiving TV channels with a cable. <i>* only on Cable mode</i>
	Clean channel list	Reset all scanned channels.
Organiser	Channel skip	Skip viewing the selected TV channel.
	Channel sort	Sort the TV channel list.
	Channel edit	Edit the TV channel list.
Input settings	CMP Name	Set the device name (No label/DVD/Blu-ray/HDD/DVDR/HD rec./Game/VCR/PC/Digital STB/HD dig STB/Camera/Recorder/Other).
	AV Name	
	AV video input	Select the AV input type (Auto/S-Video/RGB/CVBS).

Input settings	VGA Name	Set the device name (No label/DVD/Blu-ray/HDD/DVDR/HD rec./Game/VCR/PC/Digital STB/HD dig STB/Camera/Recorder/Other).
	HDMI1 Name	
	HDMI2 Name	
	HDMI3 Name	
Decode	Decode analog channels.	
Diagnostics	Display the diagnostics information about the TV. * <i>Only available for digital channels.</i>	
Time Shift	Enable/Disable the time shift feature (On/Off).	
Reset	Reset all LED TV operational settings to the factory default settings (OK/Cancel). * <i>Restores all settings to factory defaults, including Picture, Sound, Password, Country, Language, and TV program settings.</i>	
Note: The options available on the OSD may vary depending on the input signal source.		

Setup		
Option	Description	
PAP	PAP	Enable/Disable the PAP feature (On/Off).
	TV position (only available when <i>PAP</i> is set to <i>On</i>)	Set the TV window position (Left/Right).
Subtitle	Subtitle	Enable/Disable the subtitle (On/Off).
	Digital subtitle language	Set the subtitle language for digital broadcast.
	Digital subtitle language 2nd	
Subtitle	Subtitle type	Select the subtitle type mode (Normal/ Hearing impaired).
Decoding page language	Set the decoding page language for teletext display (Arabic/ Byelorussian/West EUR/East EUR/Russian/Russian-2/Greek/ Turkish/Arabic/Hebrew/Farsi).	
Digital teletext language	Set the teletext language for digital broadcast.	
SPDIF type	Select the SPDIF type mode (PCM/Off/Dolby D).	
SPDIF Delay (only available when <i>SPDIF type</i> is set to <i>PCM</i>)	Adjust the SPDIF delay time to synchronize the sound with the picture (0~1000).	
T-Link	To search for CEC devices connected to the HDMI sockets of the TV and enable one-touch play and one-touch standby between CEC devices (On/Off).	

Common interface (the CI slot as CI+)	Access common interface services. * <i>This menu option is only available if the common interface module is correctly inserted and activated. The on-screen applications and content are provided by your digital TV service operator.</i>	
Location	Set your current location (Home/Shop).	
Software update	Enable you to install the latest version of the software if available.	
Timer	Time zone	Set the time zone.
	Clock	Set the clock settings. - Auto synchronization (On/Off) - Power on timer (Off/Daily/Once) - Power on channel <i>(only available when Power on time is set to Daily/Once)</i> - Power off timer (Off/Daily/Once)
	Sleep timer	Set the timer to turn the TV off at the preset time.

Parental		
Option	Description	
Channel lock	Block any channels that you do not want to watch or that you do not want your children to watch.	
Parental rating	Age rating	Prevent children from watching certain TV programs, according to the ratings limit set (None/4~18).
Input lock	Select the input source that you want to block (TV/CMP/AV/VGA/HDMI1/HDMI2/HDMI3).	
Front panel lock	Enable/Disable the front panel lock feature (On/Off).	
Installation lock	Enable/Disable the Installation lock (On/Off).	
Max volume	Set the maximum volume (0~100).	
Change password	New password	Set the new password.
	Confirm password	Enter the new password again to confirmation.
Clean all	Reset all parental settings to the factory default settings (OK/Cancel).	
Note: <ul style="list-style-type: none"> • The default password is 1234. • The Channel lock is only accessible in TV mode. 		

Media Center Menu

Your TV is equipped with a USB connector that enables you to view photos, listen to music, or watch videos stored on a USB storage device.

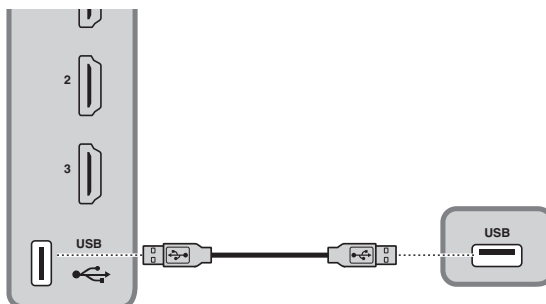

Device	File Format
USB 2.0 device	USB memory, USB card reader
File System	FAT/FAT 32/NTFS
Photo file format	JPEG (*.JPG)
Music format	MPEG1 (*.MP3) Bitrate: 32k, 64k, 96k, 128k, 196k, 256k, 320kbps Sampling frequency: 32k, 44.1k, 48kHz
Video file format	MPEG1/2 (*.AVI, *.MPG, *.MPEG, *.TS) MPEG4 (*.AVI, *.MP4) H.264 (*.AVI, *.MP4, *.TS)

Plug a USB device to the USB connector on the TV. When this USB device is detected, it enters the **Media Center** menu directly.

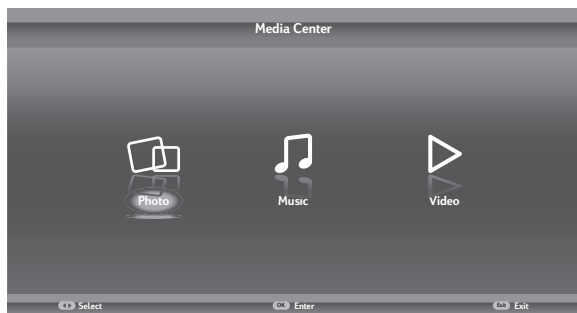

Viewing Photos

- 1 Select **Media Center** > **Photo**, then press **OK** to enter the main file content browser.
- 2 In the main file content browser, use ▲/▼/◀/▶ to select a photo or an inner file folder.
 - Select an inner file folder, press **OK** to enter a sub file content browser.
 - Press **Menu** to display the photo menu in the folder mode.
 - **Sort**: Sort folders and photos by Date or Name.
 - **Edit**: Copy, Paste, or Delete a selected photo.
 - **Parser**: Select **Recursive** to display photos from all sub file folders.
- 3 Select a photo, press **OK** to view in full screen, and a slide show begins from the selected photo.
 - Press **Menu** to display the photo menu in the browser mode. You can play, pause or rotate the photo, and set other related slide show settings.
- 4 Press **OK** to pause the slide show.
 - Press ▲/▼ to view the previous or next photo.

Playback Music

- 1 Select **Media Center > Music**, then press **OK** to enter the main file content browser.
- 2 In the main file content browser, use **▲/▼/◀/▶** to select a song or an inner file folder.
 - Select an inner file folder, press **OK** to enter a sub file content browser.
 - Press **Menu** to display the music menu in the folder mode.
 - **Sort**: Sort folders and songs by Name, Genre, Artist, or Album.
 - **Edit**: Copy, Paste, or Delete a selected song.
 - **Parser**: Select **Recursive** to display songs from all sub file folders.
- 3 Select a song, press **OK** to play, and an automatic playback begins from the selected song.
 - Press **Menu** to display the music menu in the browser mode. You can play or pause the song, select different play mode, and set other related playback settings.
- 4 Press the related buttons on the remote control to perform the available functions shown on the function bar at the bottom of the TV screen.

Watching Videos

- 1 Select **Media Center > Video**, then press **OK** to enter the main file content browser.
- 2 In the main file content browser, use **▲/▼/◀/▶** to select a video or an inner file folder.
 - Select an inner file folder, press **OK** to enter a sub file content browser.
 - Press **Menu** to display the video menu in the folder mode.
 - **Sort**: Sort folders and videos by Type, Date, or Name.
 - **Edit**: Copy, Paste, or Delete a selected video.
 - **Parser**: Select **Recursive** to display videos from all sub file folders.
- 3 Select a video, press **OK** to play, and an automatic playback begins from the selected video.
 - Press **Menu** to display the video menu in the browser mode. You can play or pause the video, select different play mode, and set other related playback settings.
- 4 Press the related buttons on the remote control to perform the available functions shown on the function bar at the bottom of the TV screen.

Time Shift Function

Allows you to record the TV program so that you won't miss the favorite part even if you go out. Before you use the function, connect a USB device to the TV first. For the first time, you should do the disk setup for the USB device.

- 1 Press **Menu** on the remote control and select **TV > Time shift**.
- 2 Press **◀/▶** to select **On** to switch on the time shift function, then press **Exit** to close the menu.
- 3 Press **Option** on the remote control and select **Time shift**, then press **OK** to confirm.
- 4 Follow the directions on the screen to do the setup.
- 5 After the disk setup is done, press **Option** and select **Time shift**.

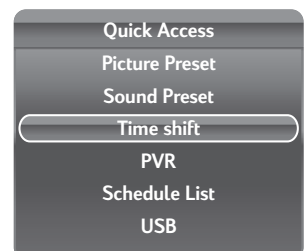

- 6 Press **OK** to display the time shift menu.
 - Press the red button to pause the picture and begin the time shift.
 - Press the red button to play the recorded part.
 - When the time shift menu disappears and only the timing of the time shift remains on the screen, you can press the red button or **OK** to call out the time shift menu.
 - Press the green button to fast backward or the yellow button to fast forward.
 - Press the blue button to quit the time shift function.

Notes:

- Before you plug the USB device to TV, make sure you have backed up the data in the device to avoid the unusual performance make your important data lost.
- We recommend you use a USB device with the free file size bigger than 1Gb and disk speed faster than 5.0M/sec.
- The bigger file size for the time shift, the longer you can record the program.
- If changing channel in time shifting, a message prompts to let you select **Yes** or **No**. You can select **Yes** to exit the time shift function and execute the channel change.

PVR (Personal Video Record)

This function allows you to record your favorite TV program to a USB device.

- 1 Plug a USB device to the USB connector on the TV.
- 2 Press **Option** on the remote control and select **Quick access > PVR**.
- 3 Press **OK/▶** to enter.
- 4 Press the red button to start recording. A PVR mini panel appears on the screen to indicate the recording progress.
 - Use **▲/▼/◀/▶** to adjust the recording duration.
 - Press the green button to stop recording manually. Otherwise, the recording will stop automatically when the recording duration is complete.
 - The recorded file is saved into a PVR folder in **Media Center > Video > pvr**.

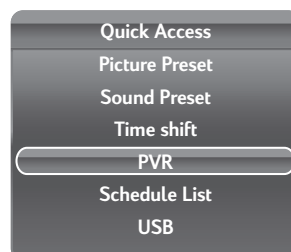





- 5 To watch the recorded program, exit the **PVR** mode first and switch to **USB** mode. Go to **Media Center > Video** and select the desired recorded file in the PVR folder. Press **OK** to play.

Notes:

- When CI+ card is used, this function will be disabled.
- This function is only available for digital channels.
- This function only supports USB device of FAT32 format.
- Before you plug the USB device to the TV, make sure that you have backed up the data in the device to avoid the unusual performance that might cause data lost.
- The bigger storage size of the USB device for PVR function, the longer you can record the program.
- If you want to switch the channel or signal source during recording, it will prompt you whether to stop recording, select **OK** if you want to save the recorded data. Then switch to a new channel or signal source.
- The TV can not play files normally if the file parameters exceed the system limitations, the file format is not supported, the file is damaged, or the file can not be decoded.
- Do not unplug the USB device when the system is recording data or reading a file. This may cause system or device malfunction.

4. Troubleshooting

Situation	Solution
No picture and sound.	<ul style="list-style-type: none"> • Connect the power cord properly. • Check if the power LED is on or not. • Press  on the control panel or remote control. • Press Source on the remote control to select the connected video sources. • Press P  or P  on the remote control or the control panel to switch to other TV programs. • Make sure all cables are connected properly.
No picture, or poor picture, sound is OK.	<ul style="list-style-type: none"> • Check the antenna and cable connections. • Adjust the Brightness in the Picture menu.
Picture is not in color.	<ul style="list-style-type: none"> • Try the Picture preset function in the Picture menu.
Picture is OK, no sound.	<ul style="list-style-type: none"> • Make sure the source device is functioning properly. • Make sure the audio cable is connected securely. • Turn the mute off. • Press VOL + on the control panel or  + on the remote control.
One of the speakers has no sound.	<ul style="list-style-type: none"> • Adjust the Balance in the Sound menu.
Cannot receive some TV channels using cable TV.	<ul style="list-style-type: none"> • Try the Automatic search function in the TV menu.
Want to reset TV settings.	<ul style="list-style-type: none"> • Use the Reset function in the TV menu.
Cannot operate menus.	<ul style="list-style-type: none"> • If OSD items are colored in gray, the system is in a state such that those settings are not available.
Screen image turns over.	<ul style="list-style-type: none"> • Make sure the video signal cable is connected properly.
Snow appears on the screen.	<ul style="list-style-type: none"> • Adjust the location of the antenna, placing it far from roads or sources of interference. • Check the antenna and the video signal line connections.
Blurred or overlapped images.	<ul style="list-style-type: none"> • Adjust the sharpness setting. • Choose programs with high quality signals. • Adjust the direction of the antenna or replace the video signal cable.
Remote control doesn't work.	<ul style="list-style-type: none"> • Make sure the battery is inserted correctly. • Replace the battery with a new one. • Make sure the TV power cord is plugged in. • Make sure the path between the remote control and the sensor is clear. • Try operating the remote control at a closer distance to the TV.

5. Support Timing

PC Mode Support Timing		Video Mode Support Timing	
Resolution	Frequency	Resolution (active dot)	HDMI/Component
640 x 480	60Hz	480i	V
640 x 480	75Hz	576i	V
800 x 600	60Hz	480p	V
800 x 600	75Hz	576p	V
1024 x 768	60Hz	720p	V
1024 x 768	75Hz	1080i	V
1360 x 768	60Hz	1080p	V

6. Specifications

Model No.	AD32U	
DISPLAY		
Screen Size	81.2 cm / 32 inches	
Aspect Ratio	16:9	
Resolution	1366 x 768	
OSD Language	English, Spanish, French, German, Italy, Czech, Croatian, Danish, Hungarian, Dutch, Norwegian, Polish, Portuguese, Romanian, Slovak, Slovenian, Serbian, Finnish, Swedish, Turkish, Greek, Bulgarian, Russian, Latvian, Lithuanian, Estonian, Ukrainian	
ENHANCEMENT		
Sound Output (RMS Watts)	5W + 5W	
Sound Mode	Rock, Pop, Live, Dance, Techno, Classic, Soft, Personal, Off	
Picture Format	Cinerama, 14:9 Zoom, 16:9 Zoom, 16:9 Zoom up, 16:9 format, 4:3 format, Wide Zoom, Zoom 2, Wide Zoom 2, Stretch Zoom	
Picture Mode	ECO, Vivid, Studio, Personal, Movie	
CONNECTION		
Rear Connectors	- Tuner Input (75 Ω) - Component Input - PC IN: D-SUB and PC Audio - SCART	
Side Connectors	- SPDIF Output - USB - HDMI 2 - Earphone Output - HDMI 1 - HDMI 3 - Common Interface	
WEIGHT & DIMENSIONS		
Product Dimensions (W x H x D mm)	With Stand	734.7 x 488.4 x 183
	Without Stand	734.7 x 441.3 x 68.7
Net Weight	With Stand	8.2kg
	Without Stand	6.6kg
POWER		
Main power - Operation (Max.)	70W	
Standby	< 0.5 W	
Main Power	220-240V~ 50Hz	
Ambient Temperature	5°C ~ 35°C	